

## Adalimumab, etanercept, infliximab, certolizumab pegol, golimumab, tocilizumab and abatacept for the treatment of rheumatoid arthritis not previously treated with disease-modifying antirheumatic drugs and after the failure of conventional disease-modifying antirheumatic drugs only: systematic review and economic evaluation

*Matt Stevenson, Rachel Archer, Jon Tosh, Emma Simpson, Emma Everson-Hock, John Stevens, Monica Hernandez-Alava, Suzy Paisley, Kath Dickinson, David Scott, Adam Young and Allan Wailoo*



**National Institute for  
Health Research**



# **Adalimumab, etanercept, infliximab, certolizumab pegol, golimumab, tocilizumab and abatacept for the treatment of rheumatoid arthritis not previously treated with disease-modifying antirheumatic drugs and after the failure of conventional disease-modifying antirheumatic drugs only: systematic review and economic evaluation**

Matt Stevenson,<sup>1\*</sup> Rachel Archer,<sup>1</sup> Jon Tosh,<sup>1</sup>  
Emma Simpson,<sup>1</sup> Emma Everson-Hock,<sup>1</sup> John Stevens,<sup>1</sup>  
Monica Hernandez-Alava,<sup>1</sup> Suzy Paisley,<sup>1</sup>  
Kath Dickinson,<sup>1</sup> David Scott,<sup>2</sup> Adam Young<sup>3</sup>  
and Allan Wailoo<sup>1</sup>

<sup>1</sup>School of Health and Related Research (SchARR), University of Sheffield, Sheffield, UK

<sup>2</sup>Department of Rheumatology, King's College Hospital NHS Foundation Trust, London, UK

<sup>3</sup>Department of Rheumatology, West Hertfordshire Hospitals NHS Trust, Hertfordshire, UK

\*Corresponding author

**Declared competing interests of authors:** David Scott has received honoraria within the last 3 years for providing advice to Merck Sharp & Dohme Corp., UCB Pharma and Bristol-Myers Squibb: these values were less than £1000. Additionally, David Scott has received grants from Arthritis Research UK and the National Institute for Health Research in connection with rheumatoid arthritis.

Published April 2016

DOI: 10.3310/hta20350



This report should be referenced as follows:

Stevenson M, Archer R, Tosh J, Simpson E, Everson-Hock E, Stevens J, *et al.* Adalimumab, etanercept, infliximab, certolizumab pegol, golimumab, tocilizumab and abatacept for the treatment of rheumatoid arthritis not previously treated with disease-modifying antirheumatic drugs and after the failure of conventional disease-modifying antirheumatic drugs only: systematic review and economic evaluation. *Health Technol Assess* 2016;**20**(35).

*Health Technology Assessment* is indexed and abstracted in *Index Medicus/MEDLINE*, *Excerpta Medica/EMBASE*, *Science Citation Index Expanded (SciSearch®)* and *Current Contents®/Clinical Medicine*.



ISSN 1366-5278 (Print)

ISSN 2046-4924 (Online)

Impact factor: 5.027

*Health Technology Assessment* is indexed in MEDLINE, CINAHL, EMBASE, The Cochrane Library and the ISI Science Citation Index.

This journal is a member of and subscribes to the principles of the Committee on Publication Ethics (COPE) ([www.publicationethics.org/](http://www.publicationethics.org/)).

Editorial contact: [nhredit@southampton.ac.uk](mailto:nhredit@southampton.ac.uk)

The full HTA archive is freely available to view online at [www.journalslibrary.nihr.ac.uk/hta](http://www.journalslibrary.nihr.ac.uk/hta). Print-on-demand copies can be purchased from the report pages of the NIHR Journals Library website: [www.journalslibrary.nihr.ac.uk](http://www.journalslibrary.nihr.ac.uk)

## Criteria for inclusion in the *Health Technology Assessment* journal

Reports are published in *Health Technology Assessment* (HTA) if (1) they have resulted from work for the HTA programme, and (2) they are of a sufficiently high scientific quality as assessed by the reviewers and editors.

Reviews in *Health Technology Assessment* are termed 'systematic' when the account of the search appraisal and synthesis methods (to minimise biases and random errors) would, in theory, permit the replication of the review by others.

## HTA programme

The HTA programme, part of the National Institute for Health Research (NIHR), was set up in 1993. It produces high-quality research information on the effectiveness, costs and broader impact of health technologies for those who use, manage and provide care in the NHS. 'Health technologies' are broadly defined as all interventions used to promote health, prevent and treat disease, and improve rehabilitation and long-term care.

The journal is indexed in NHS Evidence via its abstracts included in MEDLINE and its Technology Assessment Reports inform National Institute for Health and Care Excellence (NICE) guidance. HTA research is also an important source of evidence for National Screening Committee (NSC) policy decisions.

For more information about the HTA programme please visit the website: <http://www.nets.nihr.ac.uk/programmes/hta>

## This report

The research reported in this issue of the journal was commissioned and funded by the HTA programme on behalf of NICE as project number 11/74/01. The protocol was agreed in November 2012. The assessment report began editorial review in October 2013 and was accepted for publication in January 2015. The authors have been wholly responsible for all data collection, analysis and interpretation, and for writing up their work. The HTA editors and publisher have tried to ensure the accuracy of the authors' report and would like to thank the reviewers for their constructive comments on the draft document. However, they do not accept liability for damages or losses arising from material published in this report.

This report presents independent research funded by the National Institute for Health Research (NIHR). The views and opinions expressed by authors in this publication are those of the authors and do not necessarily reflect those of the NHS, the NIHR, NETSCC, the HTA programme or the Department of Health. If there are verbatim quotations included in this publication the views and opinions expressed by the interviewees are those of the interviewees and do not necessarily reflect those of the authors, those of the NHS, the NIHR, NETSCC, the HTA programme or the Department of Health.

© Queen's Printer and Controller of HMSO 2016. This work was produced by Stevenson *et al.* under the terms of a commissioning contract issued by the Secretary of State for Health. This issue may be freely reproduced for the purposes of private research and study and extracts (or indeed, the full report) may be included in professional journals provided that suitable acknowledgement is made and the reproduction is not associated with any form of advertising. Applications for commercial reproduction should be addressed to: NIHR Journals Library, National Institute for Health Research, Evaluation, Trials and Studies Coordinating Centre, Alpha House, University of Southampton Science Park, Southampton SO16 7NS, UK.

Published by the NIHR Journals Library ([www.journalslibrary.nihr.ac.uk](http://www.journalslibrary.nihr.ac.uk)), produced by Prepress Projects Ltd, Perth, Scotland ([www.prepress-projects.co.uk](http://www.prepress-projects.co.uk)).

## Health Technology Assessment Editor-in-Chief

**Professor Hywel Williams** Director, HTA Programme, UK and Foundation Professor and Co-Director of the Centre of Evidence-Based Dermatology, University of Nottingham, UK

## NIHR Journals Library Editor-in-Chief

**Professor Tom Walley** Director, NIHR Evaluation, Trials and Studies and Director of the HTA Programme, UK

## NIHR Journals Library Editors

**Professor Ken Stein** Chair of HTA Editorial Board and Professor of Public Health, University of Exeter Medical School, UK

**Professor Andree Le May** Chair of NIHR Journals Library Editorial Group (EME, HS&DR, PGfAR, PHR journals)

**Dr Martin Ashton-Key** Consultant in Public Health Medicine/Consultant Advisor, NETSCC, UK

**Professor Matthias Beck** Chair in Public Sector Management and Subject Leader (Management Group), Queen's University Management School, Queen's University Belfast, UK

**Professor Aileen Clarke** Professor of Public Health and Health Services Research, Warwick Medical School, University of Warwick, UK

**Dr Tessa Crilly** Director, Crystal Blue Consulting Ltd, UK

**Dr Peter Davidson** Director of NETSCC, HTA, UK

**Ms Tara Lamont** Scientific Advisor, NETSCC, UK

**Professor Elaine McColl** Director, Newcastle Clinical Trials Unit, Institute of Health and Society, Newcastle University, UK

**Professor William McGuire** Professor of Child Health, Hull York Medical School, University of York, UK

**Professor Geoffrey Meads** Professor of Health Sciences Research, Health and Wellbeing Research and Development Group, University of Winchester, UK

**Professor John Norrie** Health Services Research Unit, University of Aberdeen, UK

**Professor John Powell** Consultant Clinical Adviser, National Institute for Health and Care Excellence (NICE), UK

**Professor James Raftery** Professor of Health Technology Assessment, Wessex Institute, Faculty of Medicine, University of Southampton, UK

**Dr Rob Riemsma** Reviews Manager, Kleijnen Systematic Reviews Ltd, UK

**Professor Helen Roberts** Professor of Child Health Research, UCL Institute of Child Health, UK

**Professor Jonathan Ross** Professor of Sexual Health and HIV, University Hospital Birmingham, UK

**Professor Helen Snooks** Professor of Health Services Research, Institute of Life Science, College of Medicine, Swansea University, UK

**Professor Jim Thornton** Professor of Obstetrics and Gynaecology, Faculty of Medicine and Health Sciences, University of Nottingham, UK

Please visit the website for a list of members of the NIHR Journals Library Board:  
[www.journalslibrary.nihr.ac.uk/about/editors](http://www.journalslibrary.nihr.ac.uk/about/editors)

**Editorial contact:** [nihredit@southampton.ac.uk](mailto:nihredit@southampton.ac.uk)



# Abstract

## Adalimumab, etanercept, infliximab, certolizumab pegol, golimumab, tocilizumab and abatacept for the treatment of rheumatoid arthritis not previously treated with disease-modifying antirheumatic drugs and after the failure of conventional disease-modifying antirheumatic drugs only: systematic review and economic evaluation

Matt Stevenson,<sup>1\*</sup> Rachel Archer,<sup>1</sup> Jon Tosh,<sup>1</sup> Emma Simpson,<sup>1</sup> Emma Everson-Hock,<sup>1</sup> John Stevens,<sup>1</sup> Monica Hernandez-Alava,<sup>1</sup> Suzy Paisley,<sup>1</sup> Kath Dickinson,<sup>1</sup> David Scott,<sup>2</sup> Adam Young<sup>3</sup> and Allan Wailoo<sup>1</sup>

<sup>1</sup>School of Health and Related Research (SchARR), University of Sheffield, Sheffield, UK

<sup>2</sup>Department of Rheumatology, King's College Hospital NHS Foundation Trust, London, UK

<sup>3</sup>Department of Rheumatology, West Hertfordshire Hospitals NHS Trust, Hertfordshire, UK

\*Corresponding author [m.d.stevenson@sheffield.ac.uk](mailto:m.d.stevenson@sheffield.ac.uk)

**Objectives:** Rheumatoid arthritis (RA) is a chronic inflammatory disease associated with increasing disability, reduced quality of life and substantial costs (as a result of both intervention acquisition and hospitalisation). The objective was to assess the clinical effectiveness and cost-effectiveness of seven biologic disease-modifying antirheumatic drugs (bDMARDs) compared with each other and conventional disease-modifying antirheumatic drugs (cDMARDs). The decision problem was divided into those patients who were cDMARD naive and those who were cDMARD experienced; whether a patient had severe or moderate to severe disease; and whether or not an individual could tolerate methotrexate (MTX).

**Data sources:** The following databases were searched: MEDLINE from 1948 to July 2013; EMBASE from 1980 to July 2013; Cochrane Database of Systematic Reviews from 1996 to May 2013; Cochrane Central Register of Controlled Trials from 1898 to May 2013; Health Technology Assessment Database from 1995 to May 2013; Database of Abstracts of Reviews of Effects from 1995 to May 2013; Cumulative Index to Nursing and Allied Health Literature from 1982 to April 2013; and TOXLINE from 1840 to July 2013. Studies were eligible for inclusion if they evaluated the impact of a bDMARD used within licensed indications on an outcome of interest compared against an appropriate comparator in one of the stated population subgroups within a randomised controlled trial (RCT). Outcomes of interest included American College of Rheumatology (ACR) scores and European League Against Rheumatism (EULAR) response. Interrogation of Early Rheumatoid Arthritis Study (ERAS) data was undertaken to assess the Health Assessment Questionnaire (HAQ) progression while on cDMARDs.

**Methods:** Network meta-analyses (NMAs) were undertaken for patients who were cDMARD naive and for those who were cDMARD experienced. These were undertaken separately for EULAR and ACR data. Sensitivity analyses were undertaken to explore the impact of including RCTs with a small proportion of bDMARD experienced patients and where MTX exposure was deemed insufficient. A mathematical model was constructed to simulate the experiences of hypothetical patients. The model was based on EULAR response as this is commonly used in clinical practice in England. Observational databases,

published literature and NMA results were used to populate the model. The outcome measure was cost per quality-adjusted life-year (QALY) gained.

**Results:** Sixty RCTs met the review inclusion criteria for clinical effectiveness, 38 of these trials provided ACR and/or EULAR response data for the NMA. Fourteen additional trials contributed data to sensitivity analyses. There was uncertainty in the relative effectiveness of the interventions. It was not clear whether or not formal ranking of interventions would result in clinically meaningful differences. Results from the analysis of ERAS data indicated that historical assumptions regarding HAQ progression had been pessimistic. The typical incremental cost per QALY of bDMARDs compared with cDMARDs alone for those with severe RA is > £40,000. This increases for those who cannot tolerate MTX (£50,000) and is > £60,000 per QALY when bDMARDs were used prior to cDMARDs. Values for individuals with moderate to severe RA were higher than those with severe RA. Results produced using EULAR and ACR data were similar. The key parameter that affected the results is the assumed HAQ progression while on cDMARDs. When historic assumptions were used typical incremental cost per QALY values fell to £38,000 for those with severe disease who could tolerate MTX.

**Conclusions:** bDMARDs appear to have cost per QALY values greater than the thresholds stated by the National Institute for Health and Care Excellence for interventions to be cost-effective. Future research priorities include: the evaluation of the long-term HAQ trajectory while on cDMARDs; the relationship between HAQ direct medical costs; and whether or not bDMARDs could be stopped once a patient has achieved a stated target (e.g. remission).

**Study registration:** This study is registered as PROSPERO CRD42012003386.

**Funding:** The National Institute for Health Research Health Technology Assessment programme.

# Contents

<b>List of tables</b>	<b>xiii</b>
<b>List of figures</b>	<b>xxxix</b>
<b>List of boxes</b>	<b>xlvii</b>
<b>List of abbreviations</b>	<b>xlix</b>
<b>Plain English summary</b>	<b>liii</b>
<b>Scientific summary</b>	<b>lv</b>
<b>Chapter 1 Background</b>	<b>1</b>
Description of health problem	1
<i>Aetiology</i>	1
<i>Epidemiology</i>	1
<i>Incidence and prevalence</i>	2
<i>Significance for the NHS</i>	3
Current service provision	3
<i>Clinical guidelines</i>	3
<i>Current National Institute for Health and Care Excellence technology appraisal guidance</i>	3
<i>National Institute for Health and Care Excellence criteria for continuing treatment</i>	4
Description of the technologies under assessment	4
<i>Interventions considered in the scope of this report</i>	4
<i>Mode of action</i>	4
<i>Marketing licence and administration method</i>	5
<i>Current usage in the NHS</i>	5
<i>Identification of important subgroups</i>	5
<i>The anticipated costs associated with the interventions</i>	6
<i>Additional treatments in a sequenced strategy</i>	6
<b>Chapter 2 Definition of the decision problem</b>	<b>9</b>
Decision problem	9
<i>Interventions</i>	9
<i>Populations (including subgroups)</i>	9
<i>Populations outside the scope of the research</i>	10
<i>Relevant comparators</i>	10
<i>Outcomes</i>	10
Overall aims and objectives of assessment	11
<b>Chapter 3 Assessment of clinical effectiveness</b>	<b>13</b>
Methods for reviewing effectiveness	13
<i>Identification of studies</i>	13
<i>Inclusion and exclusion criteria</i>	14
<i>Data abstraction and critical appraisal strategy</i>	17
<i>Methods of data synthesis</i>	17
<i>Methods for the estimation of efficacy using network meta-analysis</i>	17

Results	21
<i>Quantity and quality of research available</i>	21
<i>Summary of trials and population characteristics</i>	27
<i>Assessment of effectiveness</i>	31
<i>Additional evidence (trial data not eligible for full systematic review but included to inform network meta-analysis sensitivity analyses for populations 2 and 3)</i>	58
Network meta-analysis results	58
<i>Population 1 (methotrexate naive)</i>	58
<i>Populations 2 and 3 (methotrexate-experienced populations)</i>	77
Discussion of systematic reviewing results	123
<i>Other efficacy outcomes</i>	124
<b>Chapter 4 Assessment of cost-effectiveness</b>	<b>125</b>
Systematic review of existing cost-effectiveness evidence	125
<i>Methods for reviewing existing cost-effectiveness evidence</i>	125
<i>Results</i>	127
Critique of the manufacturers' submissions	134
<i>Decision problem addressed</i>	135
<i>Strategies modelled</i>	135
<i>Model structure/time cycle</i>	141
<i>Time horizon</i>	146
<i>Perspective</i>	146
<i>Population characteristics</i>	147
<i>The assumed costs of the interventions</i>	152
<i>Administration and monitoring costs</i>	159
<i>Comparative treatment efficacy (network meta-analysis)</i>	166
<i>Responder criteria</i>	188
<i>Health Assessment Questionnaire/European Quality of Life-5 Dimensions changes in relation to response levels</i>	189
<i>Health Assessment Questionnaire trajectory following initial response</i>	194
<i>Time to discontinuation of treatment</i>	196
<i>Rebound post treatment</i>	205
<i>Assumed NHS costs per Health Assessment Questionnaire band</i>	205
<i>Utility related to the Health Assessment Questionnaire</i>	208
<i>The assumed costs and disutilities associated with adverse events</i>	213
<i>Mortality associated with rheumatoid arthritis</i>	217
<i>Cost-effectiveness results within the manufacturers' submission</i>	220
<i>Budget impact</i>	236
Independent economic assessment	237
<i>Description of the Assessment Group's model</i>	237
<i>The decision problem addressed</i>	238
<i>The strategies modelled</i>	238
<i>Model structure/time cycle</i>	240
<i>Time horizon</i>	242
<i>Perspective</i>	242
<i>Discounting</i>	242
<i>Population characteristics</i>	242
<i>Costs of the interventions</i>	242
<i>Costs of administration and monitoring</i>	243
<i>Comparative treatment efficacy (network meta-analysis)</i>	244
<i>Responder criteria</i>	249
<i>Health Assessment Questionnaire/European Quality of Life-5 Dimensions changes in relation to response levels</i>	249

<i>Health Assessment Questionnaire trajectory following initial response</i>	251
<i>Time to discontinuation on treatment</i>	257
<i>Rebound post treatment</i>	259
<i>Assumed NHS costs per Health Assessment Questionnaire band</i>	259
<i>Utility related to Health Assessment Questionnaire</i>	259
<i>The assumed costs and disutilities associated with adverse events</i>	262
<i>Mortality associated with rheumatoid arthritis</i>	264
<i>Calculation of the appropriate number of patients to run when generating results</i>	265
<i>Results</i>	266
Interpretation of the results	342
<i>Methotrexate-experienced rheumatoid arthritis patients</i>	342
<i>Methotrexate-naive rheumatoid arthritis patients</i>	343
Discussion	343
<i>Summary of key results</i>	343
<i>Comparison of the Assessment Group results and those produced by the companies</i>	343
<i>Generalisability of results</i>	344
<i>Strengths and limitations of analysis</i>	344
<b>Chapter 5 Assessment of factors relevant to the NHS and other parties</b>	<b>345</b>
<b>Chapter 6 Discussion</b>	<b>347</b>
Statement of principal findings	347
Strengths and limitations of the assessment	347
Uncertainties	348
<b>Chapter 7 Conclusions</b>	<b>349</b>
Implications for service provision	349
Suggested research priorities	349
<b>Acknowledgements</b>	<b>351</b>
<b>References</b>	<b>353</b>
<b>Appendix 1 Search strategies</b>	<b>379</b>
<b>Appendix 2 Quality assessment summary of findings</b>	<b>389</b>
<b>Appendix 3 Excluded studies</b>	<b>395</b>
<b>Appendix 4 Additional data relating to the included randomised controlled trials</b>	<b>403</b>



# List of tables

<b>TABLE 1</b> Determining EULAR response based on DAS28	2
<b>TABLE 2</b> The weight distribution of patients with RA using BSRBR data	6
<b>TABLE 3</b> Simplified mean acquisition and administration costs for each intervention	7
<b>TABLE 4</b> The relationship between the licence of the intervention and the decision problem	9
<b>TABLE 5</b> Trials included in the systematic review and NMAs	22
<b>TABLE 6</b> Trials not eligible for the systematic review but providing additional evidence for NMA sensitivity analyses	25
<b>TABLE 7</b> Population characteristics: population 1 – biologic head-to-head RCTs	27
<b>TABLE 8</b> Population characteristics: population 1 – RCTs of biologic vs. DMARD(s) or PBO	28
<b>TABLE 9</b> Population characteristics: populations 2 and 3 – biologic head-to-head RCTs	32
<b>TABLE 10</b> Population characteristics: populations 2 and 3 – cDMARD experienced vs. cDMARD(s) or PBO	33
<b>TABLE 11</b> American College of Rheumatology response data: population 1 – RCTs of biologic vs. DMARD(s) or PBO	38
<b>TABLE 12</b> American College of Rheumatology response data: populations 2 and 3 – biologic head-to-head RCTs	41
<b>TABLE 13</b> American College of Rheumatology response data: populations 2 and 3 – RCTs of biologic vs. DMARD(s) or PBO	42
<b>TABLE 14</b> European League Against Rheumatism response: population 1 – RCTs of biologic vs. DMARD(s) or PBO	47
<b>TABLE 15</b> European League Against Rheumatism response: populations 2 and 3 – biologic head-to-head RCTs	49
<b>TABLE 16</b> European League Against Rheumatism: populations 2 and 3 – RCTs of biologic vs. DMARD(s) or PBO	50
<b>TABLE 17</b> American College of Rheumatology response: populations 2 and 3 – RCTs used in the sensitivity analyses of the NMA	59
<b>TABLE 18</b> European League Against Rheumatism response: populations 2 and 3 – RCTs used in the sensitivity analyses of the NMA	61

<b>TABLE 19</b> The EULAR data used in the NMA for populations 2 and 3	<b>62</b>
<b>TABLE 20</b> The ACR data used in the NMA for populations 2 and 3	<b>64</b>
<b>TABLE 21</b> The EULAR data for population 1	<b>67</b>
<b>TABLE 22</b> The ACR data used in the NMA for population 1	<b>68</b>
<b>TABLE 23</b> American College of Rheumatology (population 1: main trials) – the number of RCTs in which each pair of interventions were compared	<b>70</b>
<b>TABLE 24</b> American College of Rheumatology (population 1: main trials) – probability of treatment rankings in terms of efficacy (most efficacious = 1)	<b>72</b>
<b>TABLE 25</b> American College of Rheumatology (population 1: main trials) – probabilities of achieving ACR responses	<b>73</b>
<b>TABLE 26</b> American College of Rheumatology (population 1: main trials + MTX experienced) – the number of RCTs with which each pair of interventions were compared	<b>74</b>
<b>TABLE 27</b> American College of Rheumatology (population 1: main trials + MTX experienced) – probability of treatment rankings in terms of efficacy (most efficacious = 1)	<b>76</b>
<b>TABLE 28</b> American College of Rheumatology (population 1: main trials + MTX experienced) – probabilities of achieving ACR responses	<b>77</b>
<b>TABLE 29</b> European League Against Rheumatism (populations 2 and 3: main trials) – the number of RCTs with which each pair of interventions were compared	<b>79</b>
<b>TABLE 30</b> European League Against Rheumatism (populations 2 and 3: main trials) – probability of treatment rankings in terms of efficacy (most efficacious = 1)	<b>83</b>
<b>TABLE 31</b> European League Against Rheumatism (populations 2 and 3: main trials) – probability of achieving EULAR responses	<b>84</b>
<b>TABLE 32</b> European League Against Rheumatism (populations 2 and 3: main trials + prior biologics) – the number of RCTs with which each pair of interventions were compared	<b>85</b>
<b>TABLE 33</b> European League Against Rheumatism (populations 2 and 3: main trials + prior biologics) – probability of treatment rankings in terms of efficacy (most efficacious = 1)	<b>89</b>
<b>TABLE 34</b> European League Against Rheumatism (populations 2 and 3: main trials) – probability of achieving EULAR responses	<b>91</b>
<b>TABLE 35</b> American College of Rheumatology (populations 2 and 3: main trials) – frequency with which each pair of interventions were compared	<b>92</b>



<b>TABLE 36</b> American College of Rheumatology (populations 2 and 3: main trials) – probability of treatment rankings in terms of efficacy (most efficacious = 1)	<b>96</b>
<b>TABLE 37</b> American College of Rheumatology (populations 2 and 3: main trials) – probability of achieving ACR responses	<b>97</b>
<b>TABLE 38</b> American College of Rheumatology (populations 2 and 3: main trials + prior biologics with AMBITION) – frequency with which each pair of interventions were compared	<b>99</b>
<b>TABLE 39</b> American College of Rheumatology (populations 2 and 3: main trials + prior biologics with AMBITION) – probability of treatment rankings in terms of efficacy (most efficacious = 1)	<b>105</b>
<b>TABLE 40</b> American College of Rheumatology (populations 2 and 3: main trials + prior biologics with AMBITION) – probability of achieving ACR responses	<b>106</b>
<b>TABLE 41</b> American College of Rheumatology (populations 2 and 3: main trials + prior biologics without AMBITION) – frequency with which each pair of interventions were compared	<b>108</b>
<b>TABLE 42</b> American College of Rheumatology (populations 2 and 3: main trials + prior biologics without AMBITION) – probability of treatment rankings in terms of efficacy (most efficacious = 1)	<b>114</b>
<b>TABLE 43</b> American College of Rheumatology (populations 2 and 3: main trials + prior biologics without AMBITION) – probability of achieving ACR responses	<b>115</b>
<b>TABLE 44</b> American College of Rheumatology (populations 2 and 3: main trials + RCTs that have potentially low prior MTX exposure) – frequency with which each pair of interventions were compared	<b>117</b>
<b>TABLE 45</b> American College of Rheumatology (populations 2 and 3: main trials + RCTs that have potentially low prior MTX exposure) – probability of treatment rankings in terms of efficacy (most efficacious = 1)	<b>121</b>
<b>TABLE 46</b> American College of Rheumatology (populations 2 and 3: main trials + RCTs that have potentially low prior MTX exposure) – probability of achieving ACR responses	<b>122</b>
<b>TABLE 47</b> Keywords for systematic review	<b>125</b>
<b>TABLE 48</b> Systematic review databases	<b>126</b>
<b>TABLE 49</b> Health economic studies assessing bDMARDs in bDMARD-naïve patients with RA	<b>128</b>
<b>TABLE 50</b> Cost-effectiveness results for studies in DMARD-naïve patients with RA	<b>130</b>
<b>TABLE 51</b> Cost-effectiveness results for studies in bDMARD-naïve patients with RA	<b>131</b>
<b>TABLE 52</b> The decision problem addressed within the manufacturers' submission	<b>136</b>

<b>TABLE 53</b> Strategies modelled by AbbVie for analyses 1 and 2	<b>137</b>
<b>TABLE 54</b> Strategies modelled by AbbVie for analysis 3	<b>137</b>
<b>TABLE 55</b> Strategies modelled by AbbVie for analyses 4 and 5	<b>137</b>
<b>TABLE 56</b> Strategies modelled by AbbVie for analysis 6	<b>138</b>
<b>TABLE 57</b> Strategies modelled by Bristol-Myers Squibb for analyses 1 and 7	<b>138</b>
<b>TABLE 58</b> Strategies modelled by MSD for analyses 1 and 7	<b>139</b>
<b>TABLE 59</b> Strategies modelled by Pfizer for analyses 1–3	<b>139</b>
<b>TABLE 60</b> Strategies modelled by Pfizer for analysis 4	<b>140</b>
<b>TABLE 61</b> Strategies modelled by UCB Pharma for analyses 1 and 4	<b>141</b>
<b>TABLE 62</b> Strategies modelled by UCB Pharma for analyses 2 and 5	<b>142</b>
<b>TABLE 63</b> The discount rates used per annum within the submissions	<b>147</b>
<b>TABLE 64</b> The baseline patient characteristics for MTX-experienced patients with moderate disease activity assumed by AbbVie	<b>148</b>
<b>TABLE 65</b> The baseline patient characteristics for MTX-experienced patients with severe disease activity assumed by AbbVie	<b>148</b>
<b>TABLE 66</b> The baseline patient characteristics for MTX-naive patients with severe disease activity assumed by AbbVie	<b>148</b>
<b>TABLE 67</b> Age and sex distributions of patients in the Bristol-Myers Squibb model	<b>149</b>
<b>TABLE 68</b> Health Assessment Questionnaire score distribution of patients in the Bristol-Myers Squibb model	<b>150</b>
<b>TABLE 69</b> The baseline characteristics of patients sampled in the Pfizer models	<b>150</b>
<b>TABLE 70</b> The patient characteristic data assumed by Roche	<b>151</b>
<b>TABLE 71</b> The baseline characteristics of the modelled population assumed by UCB Pharma	<b>152</b>
<b>TABLE 72</b> The costs of bDMARDs assumed by AbbVie	<b>153</b>
<b>TABLE 73</b> The calculation undertaken by AbbVie to establish the average expected cost per TCZ treatment	<b>153</b>
<b>TABLE 74</b> The calculation undertaken by AbbVie to establish the average expected cost per ABT treatment	<b>153</b>
<b>TABLE 75</b> The calculation undertaken by AbbVie to establish the average expected cost per IFX treatment	<b>154</b>

<b>TABLE 76</b> The calculation undertaken by AbbVie to establish the average expected cost per GOL treatment	<b>154</b>
<b>TABLE 77</b> The intervention costs assumed by Bristol-Myers Squibb	<b>155</b>
<b>TABLE 78</b> The intervention costs assumed by MSD	<b>155</b>
<b>TABLE 79</b> The number of vials assumed by MSD for weight based interventions	<b>156</b>
<b>TABLE 80</b> The intervention costs assumed by Pfizer	<b>158</b>
<b>TABLE 81</b> The intervention costs assumed by Roche	<b>158</b>
<b>TABLE 82</b> The intervention costs assumed by UCB Pharma	<b>159</b>
<b>TABLE 83</b> Monitoring costs assumed by AbbVie in the first 6 months	<b>160</b>
<b>TABLE 84</b> Annual monitoring costs assumed by AbbVie after the first 6 months	<b>161</b>
<b>TABLE 85</b> The administration costs and monitoring costs assumed by Bristol-Myers Squibb	<b>162</b>
<b>TABLE 86</b> Summarised total and annual costs assumed by Bristol-Myers Squibb	<b>163</b>
<b>TABLE 87</b> The unit costs of monitoring assumed by MSD	<b>164</b>
<b>TABLE 88</b> The assumed administration, monitoring and drug acquisition costs assumed by MSD	<b>164</b>
<b>TABLE 89</b> Unit costs of pre-treatment tests assumed by Pfizer	<b>165</b>
<b>TABLE 90</b> Pre-treatment costs per intervention assumed by Pfizer	<b>165</b>
<b>TABLE 91</b> The assumed acquisition and administration costs assumed by Pfizer	<b>167</b>
<b>TABLE 92</b> The administration costs assumed by Roche	<b>168</b>
<b>TABLE 93</b> The monitoring costs assumed by Roche for ADA, CTZ and ETN	<b>168</b>
<b>TABLE 94</b> The total costs of treatment assumed by Roche	<b>169</b>
<b>TABLE 95</b> Drug monitoring schedule: visits during first 6 months and every 6 months thereafter assumed by UCB Pharma	<b>169</b>
<b>TABLE 96</b> Summary of drug acquisition, administration and monitoring costs for each treatment comparator in the UCB Pharma model	<b>171</b>
<b>TABLE 97</b> The base-case NMA results for combination therapy, ACR responses in severe DMARD-experienced patients as produced by Pfizer	<b>184</b>
<b>TABLE 98</b> The base-case NMA results for combination therapy, HAQ changes in severe DMARD-experienced patients, ETN vs. other bDMARDs as produced by Pfizer	<b>185</b>

<b>TABLE 99</b> The base-case NMA results for monotherapy, ACR responses in severe DMARD-experienced patients as produced by Pfizer	<b>185</b>
<b>TABLE 100</b> American College of Rheumatology response by treatment: unadjusted and adjusted	<b>186</b>
<b>TABLE 101</b> The relative change reported by AbbVie in HAQ score by ACR response by treatment: moderate and severe RA, MTX experienced for bDMARD + MTX	<b>190</b>
<b>TABLE 102</b> The relative change reported by AbbVie in HAQ score by ACR response by treatment: severe RA, MTX naive for bDMARD + MTX	<b>190</b>
<b>TABLE 103</b> The relative change reported by AbbVie in HAQ score by ACR response by treatment: moderate and severe RA, MTX experienced or naive for bDMARD monotherapy	<b>191</b>
<b>TABLE 104</b> The assumed reduction in HAQ detailed by Bristol-Myers Squibb	<b>192</b>
<b>TABLE 105</b> Utility assumed by health state by MSD in the GOL submission	<b>192</b>
<b>TABLE 106</b> Utility assumed by health state by MSD in the IFX submission	<b>193</b>
<b>TABLE 107</b> The HAQ improvement by ACR response category reported by Pfizer	<b>193</b>
<b>TABLE 108</b> Improvement in HAQ score associated with ACR response assumed by Roche	<b>194</b>
<b>TABLE 109</b> The EQ-5D data reported by UCB Pharma associated with response level	<b>194</b>
<b>TABLE 110</b> Absolute annual HAQ-DI progression assumed by AbbVie	<b>195</b>
<b>TABLE 111</b> Health Assessment Questionnaire progression while on treatment after the initial 24-week period assumed by Roche	<b>196</b>
<b>TABLE 112</b> The estimated log-normal curve for cDMARD withdrawal rate calculated by AbbVie	<b>197</b>
<b>TABLE 113</b> Parameter estimates for biologic treatment withdrawal due to AEs (Gompertz function) calculated by AbbVie	<b>198</b>
<b>TABLE 114</b> Parameter estimates for biologics treatment withdrawal due to loss of efficacy (log-normal function) provided by AbbVie	<b>199</b>
<b>TABLE 115</b> The probability of AE for first-line biologics assumed by Bristol-Myers Squibb	<b>199</b>
<b>TABLE 116</b> The probability of early discontinuation on second-line biologics as estimated by Bristol-Myers Squibb	<b>200</b>
<b>TABLE 117</b> The long-term time on second-line biologics as estimated by Bristol-Myers Squibb	<b>200</b>

<b>TABLE 118</b> The probability of early discontinuation cDMARDs as assumed by Bristol-Myers Squibb	201
<b>TABLE 119</b> Long-term time on cDMARDs as assumed by Bristol-Myers Squibb	201
<b>TABLE 120</b> Time-to-treatment withdrawal assumed by MSD	201
<b>TABLE 121</b> Log-logistic survival models for all-cause treatment cessation as estimated by Pfizer	204
<b>TABLE 122</b> The hospital costs by HAQ band assumed by AbbVie	206
<b>TABLE 123</b> Multivariate regression used by MSD to estimate the number of days of hospital stay	206
<b>TABLE 124</b> The assumed annual costs of RA associated with HAQ score assumed by Pfizer	207
<b>TABLE 125</b> The inpatients visit by HAQ score assumed by Roche	207
<b>TABLE 126</b> The inpatient costs assumed by HAQ score by Roche	208
<b>TABLE 127</b> Costs by HAQ-DI category	208
<b>TABLE 128</b> The quality-of-life equations used in the MSD submission	210
<b>TABLE 129</b> The risk of serious infections assumed in the AbbVie model	213
<b>TABLE 130</b> The assumed probability of AEs used in the Bristol-Myers Squibb models	214
<b>TABLE 131</b> Hazard ratio of serious infection vs. cDMARDs presented by Pfizer	216
<b>TABLE 132</b> Costs of serious infection (using in scenario analysis only)	217
<b>TABLE 133</b> The assumed Gompertz fit to standard mortality data within the AbbVie model	218
<b>TABLE 134</b> The assumed standardised mortality ratios assumed by Pfizer	219
<b>TABLE 135</b> A summary of each manufacturer's interpretation of the cost-effectiveness analyses for their product assuming a cost per QALY threshold of £30,000	222
<b>TABLE 136</b> Incremental cost-effectiveness ratios for analysis 1 as reported by AbbVie	223
<b>TABLE 137</b> Incremental cost-effectiveness ratios for analysis 2 as reported by AbbVie	223
<b>TABLE 138</b> Incremental cost-effectiveness ratios for analysis 3 as reported by AbbVie	224

<b>TABLE 139</b> Incremental cost-effectiveness ratios for analysis 4 as reported by AbbVie	225
<b>TABLE 140</b> Incremental cost-effectiveness ratios for analysis 5 as reported by AbbVie	226
<b>TABLE 141</b> Incremental cost-effectiveness ratios for analysis 6 as reported by AbbVie	226
<b>TABLE 142</b> The probabilistic ICERs for analysis 7 provided by Bristol-Myers Squibb	228
<b>TABLE 143</b> Incremental cost-effectiveness results (DMARD-experienced severe RA patient population subgroup) provided by MSD in the GOL submission	229
<b>TABLE 144</b> Incremental cost-effectiveness results (DMARD-experienced RA patient population) provided by MSD in the GOL submission	229
<b>TABLE 145</b> Incremental cost-effectiveness results (DMARD-experienced severe RA patient population subgroup) provided by MSD in the IFX submission	230
<b>TABLE 146</b> Incremental cost-effectiveness results (DMARD-experienced RA patient population) provided by MSD in the IFX submission	230
<b>TABLE 147</b> Severe DMARD-inadequate responder combination therapy incremental analysis presented by Pfizer	231
<b>TABLE 148</b> Moderate to severe population combination therapy incremental analysis presented by Pfizer	232
<b>TABLE 149</b> Severe naive population combination therapy incremental analysis presented by Pfizer	232
<b>TABLE 150</b> Severe DMARD-inadequate responder monotherapy incremental analysis presented by Pfizer	232
<b>TABLE 151</b> The probabilistic sensitivity results supplied by Roche for analysis 8	233
<b>TABLE 152</b> Base-case results for combination treatments (severe disease activity population) provided by UCB Pharma	235
<b>TABLE 153</b> Base-case results for combination treatments (moderate disease activity population) provided by UCB Pharma	235
<b>TABLE 154</b> Base-case results for monotherapy treatments (severe disease activity population) provided by UCB Pharma	236
<b>TABLE 155</b> The incremental budget impact for ADA when used for eligible RA patients with moderate and severe disease activity over the next 5 years in England and Wales as estimated by AbbVie	236
<b>TABLE 156</b> The number of patients requiring treatment each year as estimated by Pfizer	237

<b>TABLE 157</b> Broad strategies considered possible for patients who could receive MTX	239
<b>TABLE 158</b> Broad strategies considered possible for patients who could not receive MTX	239
<b>TABLE 159</b> The strategies evaluated for populations 2 and 3 for those who can receive MTX	239
<b>TABLE 160</b> The strategies evaluated for populations 2 and 3 for those who cannot receive MTX	240
<b>TABLE 161</b> The strategies evaluated for population 1 for those who can receive MTX	240
<b>TABLE 162</b> The strategies evaluated for population 1 for those who cannot receive MTX	240
<b>TABLE 163</b> The costs of cDMARDs and RTX	243
<b>TABLE 164</b> The monitoring costs assumed in the Assessment Group model	244
<b>TABLE 165</b> The relationship between EULAR responses and ACR responses in the VARA database	248
<b>TABLE 166</b> Mean HAQ change by EULAR response category used in the model	249
<b>TABLE 167</b> Mean HAQ change by EULAR response category for those on cDMARDs	250
<b>TABLE 168</b> Sample means of baseline covariates	252
<b>TABLE 169</b> Estimated parameters and SEs in brackets	253
<b>TABLE 170</b> Identified evidence on HAQ progressions while on cDMARDs	257
<b>TABLE 171</b> Hazard ratio for mortality associated with HAQ category	264
<b>TABLE 172</b> Combinations of factors analysed in the cost-effectiveness analyses	267
<b>TABLE 173</b> Summarised results: median ICERs for all bDMARD strategies compared with the MTX-alone strategy. Populations 2 and 3 who can receive MTX	268
<b>TABLE 174</b> Summary of median ICERs for all bDMARDs compared with an SSZ-alone strategy. Populations 2 and 3 who are treated with monotherapy	269
<b>TABLE 175</b> Summarised results: median ICERs for all bDMARD strategies compared with the MTX-alone strategy. Population 1 who can receive MTX	269
<b>TABLE 176</b> Summary of median ICERs for all bDMARDs compared with a SSZ-alone strategy. Population 1 who are treated with monotherapy	270
<b>TABLE 177</b> Deterministic base-case results using EULAR data directly: ERAS cDMARD HAQ progression and a severe, MTX-experienced, RA population	271

<b>TABLE 178</b> Deterministic results having included RCTs with a small proportion of previous bDMARD use (with adequate prior MTX exposure) using EULAR data directly: ERAS cDMARD HAQ progression and a severe, MTX-experienced, RA population	271
<b>TABLE 179</b> Deterministic results having used the mapping of HAQ to utility from Malottki <i>et al.</i> rather than Hernandez-Alava <i>et al.</i> using EULAR data directly: ERAS cDMARD HAQ progression and a severe, MTX-experienced, RA population	272
<b>TABLE 180</b> Deterministic results having used discount rates of 6% per annum for costs and 1.5% per annum for QALYs and using EULAR data directly: ERAS cDMARD HAQ progression and a severe, MTX-experienced, RA population	272
<b>TABLE 181</b> Deterministic results assuming 100-fold increased impact of AEs and using EULAR data directly: ERAS cDMARD HAQ progression and a severe, MTX-experienced, RA population	273
<b>TABLE 182</b> Deterministic results having used the relationship between HAQ and pain derived from ERAS: ERAS cDMARD HAQ progression and a severe, MTX-experienced, RA population	273
<b>TABLE 183</b> Probabilistic base-case results using EULAR data directly: ERAS cDMARD HAQ progression and a severe, MTX-experienced, RA population	274
<b>TABLE 184</b> Deterministic base-case results using EULAR data directly: linear cDMARD HAQ progression and a severe, MTX-experienced, RA population	275
<b>TABLE 185</b> Deterministic results having included RCTs with a small proportion of previous bDMARD use (with adequate prior MTX exposure) using EULAR data directly: linear cDMARD HAQ progression and a severe, MTX-experienced, RA population	275
<b>TABLE 186</b> Deterministic results having used the mapping of HAQ to utility from Malottki <i>et al.</i> rather than Hernandez-Alava <i>et al.</i> using EULAR data directly: linear cDMARD HAQ progression and a severe, MTX-experienced, RA population	276
<b>TABLE 187</b> Deterministic results having used discount rates of 6% per annum for costs and 1.5% per annum for QALYs and using EULAR data directly: linear cDMARD HAQ progression and a severe, MTX-experienced, RA population	276
<b>TABLE 188</b> Deterministic results assuming 100-fold increased impact of AEs and using EULAR data directly: linear cDMARD HAQ progression and a severe, MTX-experienced, RA population	277
<b>TABLE 189</b> Deterministic results having used the relationship between HAQ and pain derived from ERAS: linear cDMARD HAQ progression and a severe, MTX-experienced, RA population	277
<b>TABLE 190</b> Probabilistic base-case results using EULAR data directly: linear cDMARD HAQ progression and a severe, MTX-experienced, RA population	278



<b>TABLE 191</b> Deterministic base-case results using ACR data mapped to EULAR data: ERAS cDMARD HAQ progression and a severe, MTX-experienced, RA population	279
<b>TABLE 192</b> Deterministic results having included RCTs with a small proportion of previous bDMARD use (with adequate prior MTX exposure) using ACR data mapped to EULAR data: ERAS cDMARD HAQ progression and a severe, MTX-experienced, RA population	279
<b>TABLE 193</b> Deterministic results having included RCTs with a small proportion of previous bDMARD use (irrespective of prior MTX exposure) using ACR data mapped to EULAR data: ERAS cDMARD HAQ progression and a severe, MTX-experienced, RA population	280
<b>TABLE 194</b> Deterministic results having included RCTs with potentially low prior MTX exposure using ACR data mapped to EULAR data: ERAS cDMARD HAQ progression and a severe, MTX-experienced, RA population	280
<b>TABLE 195</b> Deterministic results having used the mapping of HAQ to utility from Malottki <i>et al.</i> rather than Hernandez-Alava <i>et al.</i> using ACR data mapped to EULAR data: ERAS cDMARD HAQ progression and a severe, MTX-experienced, RA population	281
<b>TABLE 196</b> Deterministic results having used discount rates of 6% per annum for costs and 1.5% per annum for QALYs and using ACR data mapped to EULAR data: ERAS cDMARD HAQ progression and a severe, MTX-experienced, RA population	281
<b>TABLE 197</b> Deterministic results assuming 100-fold increased impact of AEs and using ACR data mapped to EULAR data: ERAS cDMARD HAQ progression and a severe, MTX-experienced, RA population	282
<b>TABLE 198</b> Deterministic results having used the relationship between HAQ and pain derived from ERAS: ERAS cDMARD HAQ progression and a severe, MTX-experienced, RA population	282
<b>TABLE 199</b> Probabilistic base-case results using ACR data mapped to EULAR data: ERAS cDMARD HAQ progression and a severe, MTX-experienced, RA population	283
<b>TABLE 200</b> Deterministic base-case results using ACR data mapped to EULAR data: linear cDMARD HAQ progression and a severe, MTX-experienced, RA population	284
<b>TABLE 201</b> Deterministic results having included RCTs with a small proportion of previous bDMARD use (with adequate prior MTX exposure) using ACR data mapped to EULAR data: linear cDMARD HAQ progression and a severe, MTX-experienced, RA population	284
<b>TABLE 202</b> Deterministic results having included RCTs with a small proportion of previous bDMARD use (irrespective of prior MTX exposure) using ACR data mapped to EULAR data: linear cDMARD HAQ progression and a severe, MTX-experienced, RA population	285

<b>TABLE 203</b> Deterministic results having included RCTs with potentially low prior MTX exposure using ACR data mapped to EULAR data: linear cDMARD HAQ progression and a severe, MTX-experienced, RA population	<b>285</b>
<b>TABLE 204</b> Deterministic results having used the mapping of HAQ to utility from Malottki <i>et al.</i> rather than Hernandez-Alava <i>et al.</i> using ACR data mapped to EULAR data: linear cDMARD HAQ progression and a severe, MTX-experienced, RA population	<b>286</b>
<b>TABLE 205</b> Deterministic results having used discount rates of 6% per annum for costs and 1.5% per annum for QALYs and using ACR data mapped to EULAR data: linear cDMARD HAQ progression and a severe, MTX-experienced, RA population	<b>286</b>
<b>TABLE 206</b> Deterministic results assuming 100-fold increased impact of AEs and using ACR data mapped to EULAR data: linear cDMARD HAQ progression and a severe, MTX-experienced, RA population	<b>287</b>
<b>TABLE 207</b> Deterministic results having used the relationship between HAQ and pain derived from ERAS: linear cDMARD HAQ progression and a severe, MTX-experienced, RA population	<b>287</b>
<b>TABLE 208</b> Probabilistic base-case results using ACR data mapped to EULAR data: linear cDMARD HAQ progression and a severe, MTX-experienced, RA population	<b>288</b>
<b>TABLE 209</b> Deterministic base-case results using EULAR data directly: ERAS cDMARD HAQ progression and a moderate, MTX-experienced, RA population	<b>289</b>
<b>TABLE 210</b> Deterministic results having included RCTs with a small proportion of previous bDMARD use (with adequate prior MTX exposure) using EULAR data directly: ERAS cDMARD HAQ progression and a moderate, MTX-experienced, RA population	<b>289</b>
<b>TABLE 211</b> Deterministic results having used the mapping of HAQ to utility from Malottki <i>et al.</i> rather than Hernandez-Alava <i>et al.</i> using EULAR data directly: ERAS cDMARD HAQ progression and a moderate, MTX-experienced, RA population	<b>290</b>
<b>TABLE 212</b> Deterministic results having used discount rates of 6% per annum for costs and 1.5% per annum for QALYs and using EULAR data directly: ERAS cDMARD HAQ progression and a moderate, MTX-experienced, RA population	<b>290</b>
<b>TABLE 213</b> Deterministic results assuming 100-fold increased impact of AEs and using EULAR data directly: ERAS cDMARD HAQ progression and a moderate, MTX-experienced, RA population	<b>291</b>
<b>TABLE 214</b> Deterministic results having used the relationship between HAQ and pain derived from ERAS: ERAS cDMARD HAQ progression and a moderate, MTX-experienced, RA population	<b>291</b>
<b>TABLE 215</b> Probabilistic base-case results using EULAR data directly: ERAS cDMARD HAQ progression and a moderate, MTX-experienced, RA population	<b>292</b>

<b>TABLE 216</b> Deterministic base-case results using EULAR data directly: linear cDMARD HAQ progression and a moderate, MTX-experienced, RA population	293
<b>TABLE 217</b> Deterministic results having included RCTs with a small proportion of previous bDMARD use (with adequate prior MTX exposure) using EULAR data directly: linear cDMARD HAQ progression and a moderate, MTX-experienced, RA population	293
<b>TABLE 218</b> Deterministic results having used the mapping of HAQ to utility from Malottki <i>et al.</i> rather than Hernandez-Alava <i>et al.</i> using EULAR data directly: linear cDMARD HAQ progression and a moderate, MTX-experienced, RA population	294
<b>TABLE 219</b> Deterministic results having used discount rates of 6% per annum for costs and 1.5% per annum for QALYs and using EULAR data directly: linear cDMARD HAQ progression and a moderate, MTX-experienced, RA population	294
<b>TABLE 220</b> Deterministic results assuming 100-fold increased impact of AEs and using EULAR data directly: linear cDMARD HAQ progression and a moderate, MTX-experienced, RA population	295
<b>TABLE 221</b> Deterministic results having used the relationship between HAQ and pain derived from ERAS: linear cDMARD HAQ progression and a moderate, MTX-experienced, RA population	295
<b>TABLE 222</b> Probabilistic base-case results using EULAR data directly: linear cDMARD HAQ progression and a moderate, MTX-experienced, RA population	296
<b>TABLE 223</b> Deterministic base-case results using EULAR data directly: ERAS cDMARD HAQ progression and a moderate, MTX-experienced, RA population	297
<b>TABLE 224</b> Deterministic results having included RCTs with a small proportion of previous bDMARD use (with adequate prior MTX exposure) using ACR data mapped to EULAR data: ERAS cDMARD HAQ progression and a moderate, MTX-experienced, RA population	297
<b>TABLE 225</b> Deterministic results having included RCTs with a small proportion of previous bDMARD use (irrespective of prior MTX exposure) using ACR data mapped to EULAR data: ERAS cDMARD HAQ progression and a moderate, MTX-experienced, RA population	298
<b>TABLE 226</b> Deterministic results having included RCTs with potentially low prior MTX exposure using ACR data mapped to EULAR data: ERAS cDMARD HAQ progression and a moderate, MTX-experienced, RA population	298
<b>TABLE 227</b> Deterministic results having used the mapping of HAQ to utility from Malottki <i>et al.</i> rather than Hernandez-Alava <i>et al.</i> using ACR data mapped to EULAR data: ERAS cDMARD HAQ progression and a moderate, MTX-experienced, RA population	299
<b>TABLE 228</b> Deterministic results having used discount rates of 6% per annum for costs and 1.5% per annum for QALYs and using ACR data mapped to EULAR data: ERAS cDMARD HAQ progression and a moderate, MTX-experienced, RA population	299

<b>TABLE 229</b> Deterministic results assuming 100-fold increased impact of AEs and using ACR data mapped to EULAR data: ERAS cDMARD HAQ progression and a moderate, MTX-experienced, RA population	300
<b>TABLE 230</b> Deterministic results having used the relationship between HAQ and pain derived from ERAS: ERAS cDMARD HAQ progression and a moderate, MTX-experienced, RA population	300
<b>TABLE 231</b> Probabilistic base-case results using ACR data mapped to EULAR data: ERAS cDMARD HAQ progression and a moderate, MTX-experienced, RA population	301
<b>TABLE 232</b> Deterministic base-case results using ACR data mapped to EULAR data: linear cDMARD HAQ progression and a moderate, MTX-experienced, RA population	302
<b>TABLE 233</b> Deterministic results having included RCTs with a small proportion of previous bDMARD use (with adequate prior MTX exposure) using ACR data mapped to EULAR data: linear cDMARD HAQ progression and a moderate, MTX-experienced, RA population	303
<b>TABLE 234</b> Deterministic results having included RCTs with a small proportion of previous bDMARD use (irrespective of prior MTX exposure) using ACR data mapped to EULAR data: linear cDMARD HAQ progression and a moderate, MTX-experienced, RA population	303
<b>TABLE 235</b> Deterministic results having included RCTs with potentially low prior MTX exposure using ACR data mapped to EULAR data: linear cDMARD HAQ progression and a moderate, MTX-experienced, RA population	304
<b>TABLE 236</b> Deterministic results having used the mapping of HAQ to utility from Malottki <i>et al.</i> rather than Hernandez-Alava <i>et al.</i> using ACR data mapped to EULAR data: linear cDMARD HAQ progression and a moderate, MTX-experienced, RA population	304
<b>TABLE 237</b> Deterministic results having used discount rates of 6% per annum for costs and 1.5% per annum for QALYs and using ACR data mapped to EULAR data: linear cDMARD HAQ progression and a moderate, MTX-experienced, RA population	305
<b>TABLE 238</b> Deterministic results assuming 100-fold increased impact of AEs and using ACR data mapped to EULAR data: linear cDMARD HAQ progression and a moderate, MTX-experienced, RA population	305
<b>TABLE 239</b> Deterministic results having used the relationship between HAQ and pain derived from ERAS: linear cDMARD HAQ progression and a moderate, MTX-experienced, RA population	306
<b>TABLE 240</b> Probabilistic base-case results using ACR data mapped to EULAR data: linear cDMARD HAQ progression and a moderate, MTX-experienced, RA population	306
<b>TABLE 241</b> Deterministic base-case results using EULAR data directly: ERAS cDMARD HAQ progression and a severe, MTX-experienced, RA population treated with monotherapy	307

<b>TABLE 242</b> Deterministic results having included RCTs with a small proportion of previous bDMARD use (with adequate prior MTX exposure) using EULAR data directly: ERAS cDMARD HAQ progression and a severe, MTX-experienced, RA population treated with monotherapy	308
<b>TABLE 243</b> Deterministic results having used the mapping of HAQ to utility from Malottki <i>et al.</i> rather than Hernandez-Alava <i>et al.</i> using EULAR data directly: ERAS cDMARD HAQ progression and a severe, MTX-experienced, RA population treated with monotherapy	308
<b>TABLE 244</b> Deterministic results having used discount rates of 6% per annum for costs and 1.5% per annum for QALYs and using EULAR data directly: ERAS cDMARD HAQ progression and a severe, MTX-experienced, RA population treated with monotherapy	308
<b>TABLE 245</b> Deterministic results assuming 100-fold increased impact of AEs and using EULAR data directly: ERAS cDMARD HAQ progression and a severe, MTX-experienced, RA population treated with monotherapy	309
<b>TABLE 246</b> Deterministic results having used the relationship between HAQ and pain derived from ERAS: ERAS cDMARD HAQ progression and a severe, MTX-experienced, RA population treated with monotherapy	309
<b>TABLE 247</b> Probabilistic base-case results using EULAR data directly: ERAS cDMARD HAQ progression and a severe, MTX-experienced, RA population treated with monotherapy	309
<b>TABLE 248</b> Deterministic base-case results using EULAR data directly: linear cDMARD HAQ progression and a severe, MTX-experienced, RA population treated with monotherapy	310
<b>TABLE 249</b> Deterministic results having included RCTs with a small proportion of previous bDMARD use (with adequate prior MTX exposure) using EULAR data directly: linear cDMARD HAQ progression and a severe, MTX-experienced, RA population treated with monotherapy	311
<b>TABLE 250</b> Deterministic results having used the mapping of HAQ to utility from Malottki <i>et al.</i> rather than Hernandez-Alava <i>et al.</i> using EULAR data directly: linear cDMARD HAQ progression and a severe, MTX-experienced, RA population treated with monotherapy	311
<b>TABLE 251</b> Deterministic results having used discount rates of 6% per annum for costs and 1.5% per annum for QALYs and using EULAR data directly: linear cDMARD HAQ progression and a severe, MTX-experienced, RA population treated with monotherapy	311
<b>TABLE 252</b> Deterministic results assuming 100-fold increased impact of AEs and using EULAR data directly: linear cDMARD HAQ progression and a severe, MTX-experienced, RA population treated with monotherapy	312
<b>TABLE 253</b> Deterministic results having used the relationship between HAQ and pain derived from ERAS: linear cDMARD HAQ progression and a severe, MTX-experienced, RA population treated with monotherapy	312

<b>TABLE 254</b> Probabilistic base-case results using EULAR data directly: linear cDMARD HAQ progression and a severe, MTX-experienced, RA population treated with monotherapy	312
<b>TABLE 255</b> Deterministic base-case results mapping EULAR data from ACR data: ERAS cDMARD HAQ progression and a severe, MTX-experienced, RA population treated with monotherapy	313
<b>TABLE 256</b> Deterministic results having included RCTs with a small proportion of previous bDMARD use (with adequate prior MTX exposure) mapping EULAR data from ACR data: ERAS cDMARD HAQ progression and a severe, MTX-experienced, RA population treated with monotherapy	314
<b>TABLE 257</b> Deterministic results having included RCTs with a small proportion of previous bDMARD use (irrespective of prior MTX exposure) mapping EULAR data from ACR data: ERAS cDMARD HAQ progression and a severe, MTX-experienced, RA population treated with monotherapy	314
<b>TABLE 258</b> Deterministic results having included RCTs with potentially low prior MTX exposure using ACR data mapped to EULAR data: ERAS cDMARD HAQ progression and a severe, MTX-experienced, RA population treated with monotherapy	314
<b>TABLE 259</b> Deterministic results having used the mapping of HAQ to utility from Malottki <i>et al.</i> rather than Hernandez-Alava <i>et al.</i> mapping EULAR data from ACR data: ERAS cDMARD HAQ progression and a severe, MTX-experienced, RA population treated with monotherapy	315
<b>TABLE 260</b> Deterministic results having used discount rates of 6% per annum for costs and 1.5% per annum for QALYs and mapping EULAR data from ACR data: ERAS cDMARD HAQ progression and a severe, MTX-experienced, RA population treated with monotherapy	315
<b>TABLE 261</b> Deterministic results assuming 100-fold increased impact of AEs and mapping EULAR data from ACR data: ERAS cDMARD HAQ progression and a severe, MTX-experienced, RA population treated with monotherapy	315
<b>TABLE 262</b> Deterministic results having used the relationship between HAQ and pain derived from ERAS: ERAS cDMARD HAQ progression and a severe, MTX-experienced, RA population treated with monotherapy	316
<b>TABLE 263</b> Probabilistic base-case results mapping EULAR data from ACR data: ERAS cDMARD HAQ progression and a severe, MTX-experienced, RA population treated with monotherapy	316
<b>TABLE 264</b> Deterministic base-case results mapping EULAR data from ACR data: linear cDMARD HAQ progression and a severe, MTX-experienced, RA population treated with monotherapy	317
<b>TABLE 265</b> Deterministic results having included RCTs with a small proportion of previous bDMARD use (with adequate prior MTX exposure) mapping EULAR data from ACR data: linear cDMARD HAQ progression and a severe, MTX-experienced, RA population treated with monotherapy	317

<b>TABLE 266</b> Deterministic results having included RCTs with a small proportion of previous bDMARD use (irrespective of prior MTX exposure) mapping EULAR data from ACR data: linear cDMARD HAQ progression and a severe, MTX-experienced, RA population treated with monotherapy	318
<b>TABLE 267</b> Deterministic results having included RCTs with potentially low prior MTX exposure using ACR data mapped to EULAR data: linear cDMARD HAQ progression and a severe, MTX-experienced, RA population treated with monotherapy	318
<b>TABLE 268</b> Deterministic results having used the mapping of HAQ to utility from Malottki <i>et al.</i> rather than Hernandez-Alava <i>et al.</i> mapping EULAR data from ACR data: linear cDMARD HAQ progression and a severe, MTX-experienced, RA population treated with monotherapy	318
<b>TABLE 269</b> Deterministic results having used discount rates of 6% per annum for costs and 1.5% per annum for QALYs and mapping EULAR data from ACR data: linear cDMARD HAQ progression and a severe, MTX-experienced, RA population treated with monotherapy	319
<b>TABLE 270</b> Deterministic results assuming 100-fold increased impact of AEs and mapping EULAR data from ACR data: linear cDMARD HAQ progression and a severe, MTX-experienced, RA population treated with monotherapy	319
<b>TABLE 271</b> Deterministic results having used the relationship between HAQ and pain derived from ERAS: linear cDMARD HAQ progression and a severe, MTX-experienced, RA population treated with monotherapy	319
<b>TABLE 272</b> Probabilistic base-case results mapping EULAR data from ACR data: linear cDMARD HAQ progression and a severe, MTX-experienced, RA population treated with monotherapy	320
<b>TABLE 273</b> Deterministic base-case results using EULAR data directly: ERAS cDMARD HAQ progression and a moderate, MTX-experienced, RA population treated with monotherapy	321
<b>TABLE 274</b> Deterministic results having included RCTs with a small proportion of previous bDMARD use (with adequate prior MTX exposure) using EULAR data directly: ERAS cDMARD HAQ progression and a moderate, MTX-experienced, RA population treated with monotherapy	321
<b>TABLE 275</b> Deterministic results having used the mapping of HAQ to utility from Malottki <i>et al.</i> rather than Hernandez-Alava <i>et al.</i> using EULAR data directly: ERAS cDMARD HAQ progression and a moderate, MTX-experienced, RA population treated with monotherapy	321
<b>TABLE 276</b> Deterministic results having used discount rates of 6% per annum for costs and 1.5% per annum for QALYs and using EULAR data directly: ERAS cDMARD HAQ progression and a moderate, MTX-experienced, RA population treated with monotherapy	322

<b>TABLE 277</b> Deterministic results assuming 100-fold increased impact of AEs and using EULAR data directly: ERAS cDMARD HAQ progression and a moderate, MTX-experienced, RA population treated with monotherapy	322
<b>TABLE 278</b> Deterministic results having used the relationship between HAQ and pain derived from ERAS: ERAS cDMARD HAQ progression and a moderate, MTX-experienced, RA population treated with monotherapy	322
<b>TABLE 279</b> Probabilistic base-case results using EULAR data directly: ERAS cDMARD HAQ progression and a moderate, MTX-experienced, RA population treated with monotherapy	323
<b>TABLE 280</b> Deterministic base-case results using EULAR data directly: linear cDMARD HAQ progression and a severe, MTX-experienced, RA population treated with monotherapy	324
<b>TABLE 281</b> Deterministic results having included RCTs with a small proportion of previous bDMARD use (with adequate prior MTX exposure) using EULAR data directly: linear cDMARD HAQ progression and a severe, MTX-experienced, RA population treated with monotherapy	324
<b>TABLE 282</b> Deterministic results having used the mapping of HAQ to utility from Malottki <i>et al.</i> rather than Hernandez-Alava <i>et al.</i> using EULAR data directly: linear cDMARD HAQ progression and a severe, MTX-experienced, RA population treated with monotherapy	324
<b>TABLE 283</b> Deterministic results having used discount rates of 6% per annum for costs and 1.5% per annum for QALYs and using EULAR data directly: linear cDMARD HAQ progression and a severe, MTX-experienced, RA population treated with monotherapy	325
<b>TABLE 284</b> Deterministic results assuming 100-fold increased impact of AEs and using EULAR data directly: LINEAR cDMARD HAQ progression and a severe, MTX-experienced, RA population treated with monotherapy	325
<b>TABLE 285</b> Deterministic results having used the relationship between HAQ and pain derived from ERAS: linear cDMARD HAQ progression and a severe, MTX-experienced, RA population treated with monotherapy	325
<b>TABLE 286</b> Probabilistic base-case results using EULAR data directly: linear cDMARD HAQ progression and a severe, MTX-experienced, RA population treated with monotherapy	326
<b>TABLE 287</b> Deterministic base-case results mapping EULAR data from ACR data: ERAS cDMARD HAQ progression and a moderate, MTX-experienced, RA population treated with monotherapy	327
<b>TABLE 288</b> Deterministic results having included RCTs with a small proportion of previous bDMARD use (with adequate prior MTX exposure) mapping EULAR data from ACR data: ERAS cDMARD HAQ progression and a moderate, MTX-experienced, RA population treated with monotherapy	327



<b>TABLE 289</b> Deterministic results having included RCTs with a small proportion of previous bDMARD use (irrespective of prior MTX exposure) mapping EULAR data from ACR data: ERAS cDMARD HAQ progression and a moderate, MTX-experienced, RA population treated with monotherapy	327
<b>TABLE 290</b> Deterministic results having included RCTs with potentially low prior MTX exposure using ACR data mapped to EULAR data: ERAS cDMARD HAQ progression and a moderate, MTX-experienced, RA population treated with monotherapy	328
<b>TABLE 291</b> Deterministic results having used the mapping of HAQ to utility from Malottki <i>et al.</i> rather than Hernandez-Alava <i>et al.</i> mapping EULAR data from ACR data: ERAS cDMARD HAQ progression and a moderate, MTX-experienced, RA population treated with monotherapy	328
<b>TABLE 292</b> Deterministic results having used discount rates of 6% per annum for costs and 1.5% per annum for QALYs and mapping EULAR data from ACR data: ERAS cDMARD HAQ progression and a moderate, MTX-experienced, RA population treated with monotherapy	328
<b>TABLE 293</b> Deterministic results assuming 100-fold increased impact of AEs and mapping EULAR data from ACR data: ERAS cDMARD HAQ progression and a moderate, MTX-experienced, RA population treated with monotherapy	329
<b>TABLE 294</b> Deterministic results having used the relationship between HAQ and pain derived from ERAS: ERAS cDMARD HAQ progression and a moderate, MTX-experienced, RA population treated with monotherapy	329
<b>TABLE 295</b> Probabilistic base-case results mapping EULAR data from ACR data: ERAS cDMARD HAQ progression and a moderate, MTX-experienced, RA population treated with monotherapy	329
<b>TABLE 296</b> Deterministic base-case results mapping EULAR data from ACR data: linear cDMARD HAQ progression and a moderate, MTX-experienced, RA population treated with monotherapy	330
<b>TABLE 297</b> Deterministic results having included RCTs with a small proportion of previous bDMARD use (with adequate prior MTX exposure) mapping EULAR data from ACR data: linear cDMARD HAQ progression and a moderate, MTX-experienced, RA population treated with monotherapy	331
<b>TABLE 298</b> Deterministic results having included RCTs with a small proportion of previous bDMARD use (irrespective of prior MTX exposure) mapping EULAR data from ACR data: linear cDMARD HAQ progression and a moderate, MTX-experienced, RA population treated with monotherapy	331
<b>TABLE 299</b> Deterministic results having included RCTs with potentially low prior MTX exposure using ACR data mapped to EULAR data: ERAS cDMARD HAQ progression and a moderate, MTX-experienced, RA population treated with monotherapy	331

<b>TABLE 300</b> Deterministic results having used the mapping of HAQ to utility from Malottki <i>et al.</i> rather than Hernandez-Alava <i>et al.</i> mapping EULAR data from ACR data: linear cDMARD HAQ progression and a moderate, MTX-experienced, RA population treated with monotherapy	332
<b>TABLE 301</b> Deterministic results having used discount rates of 6% per annum for costs and 1.5% per annum for QALYs and mapping EULAR data from ACR data: linear cDMARD HAQ progression and a moderate, MTX-experienced, RA population treated with monotherapy	332
<b>TABLE 302</b> Deterministic results assuming 100-fold increased impact of AEs and mapping EULAR data from ACR data: linear cDMARD HAQ progression and a moderate, MTX-experienced, RA population treated with monotherapy	332
<b>TABLE 303</b> Deterministic results having used the relationship between HAQ and pain derived from ERAS: linear cDMARD HAQ progression and a moderate, MTX-experienced, RA population treated with monotherapy	333
<b>TABLE 304</b> Probabilistic base-case results mapping EULAR data from ACR data: linear cDMARD HAQ progression and a moderate, MTX-experienced, RA population treated with monotherapy	333
<b>TABLE 305</b> Deterministic base-case results mapping EULAR data from ACR data: ERAS cDMARD HAQ progression and a severe, MTX-naive, RA population	334
<b>TABLE 306</b> Deterministic base-case results mapping EULAR data from ACR data: ERAS cDMARD HAQ progression including RCTs with some patients with prior cDMARD experience and a severe, MTX-naive, RA population	334
<b>TABLE 307</b> Deterministic results having used the mapping of HAQ to utility from Malottki <i>et al.</i> rather than Hernandez-Alava <i>et al.</i> mapping EULAR data from ACR data: ERAS cDMARD HAQ progression and a severe, MTX-naive, RA population treated	334
<b>TABLE 308</b> Deterministic results having used discount rates of 6% per annum for costs and 1.5% per annum for QALYs and mapping EULAR data from ACR data: ERAS cDMARD HAQ progression and a severe, MTX-naive, RA population treated	334
<b>TABLE 309</b> Deterministic results assuming 100-fold increased impact of AEs and mapping EULAR data from ACR data: ERAS cDMARD HAQ progression and a severe, MTX-naive, RA	335
<b>TABLE 310</b> Deterministic results having used the relationship between HAQ and pain derived from ERAS: ERAS cDMARD HAQ progression and a severe, MTX-naive, RA population	335
<b>TABLE 311</b> Probabilistic base-case results mapping EULAR data from ACR data: ERAS cDMARD HAQ progression and a severe, MTX-naive, RA population	335
<b>TABLE 312</b> Deterministic base-case results mapping EULAR data from ACR data: linear cDMARD HAQ progression and a severe, MTX-naive, RA population	336

<b>TABLE 313</b> Deterministic base-case results mapping EULAR data from ACR data: ERAS cDMARD HAQ progression including RCTs with some patients with prior cDMARD experience and a severe, MTX-naive, RA population treated with monotherapy	336
<b>TABLE 314</b> Deterministic results having used the mapping of HAQ to utility from Malottki <i>et al.</i> rather than Hernandez-Alava <i>et al.</i> mapping EULAR data from ACR data: linear cDMARD HAQ progression and a severe, MTX-naive, RA population	336
<b>TABLE 315</b> Deterministic results having used discount rates of 6% per annum for costs and 1.5% per annum for QALYs and mapping EULAR data from ACR data: linear cDMARD HAQ progression and a severe, MTX-naive, RA population	337
<b>TABLE 316</b> Deterministic results assuming 100-fold increased impact of AEs and mapping EULAR data from ACR data: linear cDMARD HAQ progression and a severe, MTX-naive, RA population	337
<b>TABLE 317</b> Deterministic results having used the relationship between HAQ and pain derived from ERAS: linear cDMARD HAQ progression and a severe, MTX-naive, RA population	337
<b>TABLE 318</b> Probabilistic base-case results mapping EULAR data from ACR data: linear cDMARD HAQ progression and a severe, MTX-naive, RA population	337
<b>TABLE 319</b> Deterministic base-case results mapping EULAR data from ACR data: ERAS cDMARD HAQ progression and a severe, MTX-naive, RA population treated with monotherapy	338
<b>TABLE 320</b> Deterministic base-case results mapping EULAR data from ACR data: ERAS cDMARD HAQ progression and a severe, MTX-naive, RA population treated with monotherapy including RCTs with a small percentage of prior cDMARD experience	338
<b>TABLE 321</b> Deterministic results having used the mapping of HAQ to utility from Malottki <i>et al.</i> rather than Hernandez-Alava <i>et al.</i> mapping EULAR data from ACR data: ERAS cDMARD HAQ progression and a severe, MTX-naive, RA population treated with monotherapy	339
<b>TABLE 322</b> Deterministic results having used discount rates of 6% per annum for costs and 1.5% per annum for QALYs and mapping EULAR data from ACR data: ERAS cDMARD HAQ progression and a severe, MTX-naive, RA population treated with monotherapy	339
<b>TABLE 323</b> Deterministic results assuming 100-fold increased impact of AEs and mapping EULAR data from ACR data: linear cDMARD HAQ progression and a severe, MTX-naive, RA population treated with monotherapy	339
<b>TABLE 324</b> Deterministic results having used the relationship between HAQ and pain derived from ERAS: ERAS cDMARD HAQ progression and a severe, MTX-naive, RA population treated with monotherapy	339

<b>TABLE 325</b> Probabilistic base-case results mapping EULAR data from ACR data: ERAS cDMARD HAQ progression and a severe, MTX-naive, RA population treated with monotherapy	<b>340</b>
<b>TABLE 326</b> Deterministic base-case results mapping EULAR data from ACR data: linear cDMARD HAQ progression and a severe, MTX-naive, RA population treated with monotherapy	<b>340</b>
<b>TABLE 327</b> Deterministic base-case results mapping EULAR data from ACR data: linear cDMARD HAQ progression and a severe, MTX-naive, RA population treated with monotherapy including RCTs with a small percentage of prior cDMARD experience	<b>341</b>
<b>TABLE 328</b> Deterministic results having used the mapping of HAQ to utility from Malottki <i>et al.</i> rather than Hernandez-Alava <i>et al.</i> mapping EULAR data from ACR data: linear cDMARD HAQ progression and a severe, MTX-naive, RA population treated with monotherapy	<b>341</b>
<b>TABLE 329</b> Deterministic results having used discount rates of 6% per annum for costs and 1.5% per annum for QALYs and mapping EULAR data from ACR data: linear cDMARD HAQ progression and a severe, MTX-naive, RA population treated with monotherapy	<b>341</b>
<b>TABLE 330</b> Deterministic results assuming 100-fold increased impact of AEs and mapping EULAR data from ACR data: linear cDMARD HAQ progression and a severe, MTX-naive, RA population treated with monotherapy	<b>341</b>
<b>TABLE 331</b> Deterministic results having used the relationship between HAQ and pain derived from ERAS: linear cDMARD HAQ progression and a severe, MTX-naive, RA population treated with monotherapy	<b>342</b>
<b>TABLE 332</b> Probabilistic base-case results mapping EULAR data from ACR data: linear cDMARD HAQ progression and a severe, MTX-naive, RA population treated with monotherapy	<b>342</b>
<b>TABLE 333</b> Quality assessment: summary of findings	<b>390</b>
<b>TABLE 334</b> Table of excluded studies with rationale for exclusion	<b>395</b>
<b>TABLE 335</b> Trial characteristics: population 1 head-to-head RCT	<b>404</b>
<b>TABLE 336</b> Trial characteristics: population 1 biologics vs. DMARD(s) or PBO	<b>405</b>
<b>TABLE 337</b> Trial characteristics: populations 2 and 3 head-to-head RCTs	<b>416</b>
<b>TABLE 338</b> Trial characteristics: populations 2 and 3 biologics vs. DMARD(s) or PBO	<b>420</b>
<b>TABLE 339</b> Trial characteristics: RCTs (ineligible for systematic review) used as additional evidence in NMA sensitivity analyses	<b>440</b>
<b>TABLE 340</b> Population characteristics additional information: population 1 head-to-head trial	<b>447</b>

<b>TABLE 341</b> Population characteristics additional information: population 1 biologic vs. DMARD(s) or PBO	448
<b>TABLE 342</b> Population characteristics additional information Population 2 Head to head trials	453
<b>TABLE 343</b> Population characteristics additional information: population 2 biologic vs. DMARD(s) or PBO	456
<b>TABLE 344</b> Population characteristics: trials providing additional evidence for the NMA	471
<b>TABLE 345</b> Population characteristics additional information: NMA sensitivity analyses trials	474
<b>TABLE 346</b> Disease Activity Score: population 1 head-to-head trial	480
<b>TABLE 347</b> Disease Activity Score: population 1 biologics vs. DMARD(s) or PBO	481
<b>TABLE 348</b> Disease Activity Score: populations 2 and 3 head to head	485
<b>TABLE 349</b> Disease Activity Score: populations 2 and 3 biologic vs. DMARD(s) or PBO	486
<b>TABLE 350</b> Health Assessment Questionnaire Disability Index: population 1 trials	493
<b>TABLE 351</b> Health Assessment Questionnaire Disability Index: populations 2 and 3 head-to-head trials	496
<b>TABLE 352</b> Health Assessment Questionnaire Disability Index: populations 2 and 3 vs. DMARD(s) or PBO	498
<b>TABLE 353</b> Joint counts and assessment of inflammation markers: population 1 RCTs of biologic vs. DMARD(s) or PBO	505
<b>TABLE 354</b> Joint counts and assessment of inflammation markers: populations 2 and 3 biologic head-to-head RCTs	508
<b>TABLE 355</b> Joint counts and assessment of inflammation markers: populations 2 and 3 RCTs of biologic vs. DMARD(s) or PBO	509
<b>TABLE 356</b> Global assessments of disease activity: population 1 RCTs of biologic vs. DMARD(s) or PBO	516
<b>TABLE 357</b> Global assessments of disease activity: populations 2 and 3 biologic head-to-head RCTs	518
<b>TABLE 358</b> Global assessments of disease activity: populations 2 and 3 RCTs of biologic vs. DMARD(s) or PBO	519
<b>TABLE 359</b> Radiographic score data: population 1 RCTs of biologic interventions vs. DMARD(s) or PBO	524

<b>TABLE 360</b> Assessments of synovitis, erosion and osteitis: population 1 RCTs of biologic interventions vs. DMARD(s) or PBO	527
<b>TABLE 361</b> Radiographic score data: populations 2 and 3 head-to-head biologic RCTs	529
<b>TABLE 362</b> Radiographic score data: populations 2 and 3 RCTs of biologic interventions vs. DMARD(s) or PBO	530
<b>TABLE 363</b> Assessments of synovitis, erosion and osteitis: populations 2 and 3 RCTs of biologic interventions vs. DMARD(s) or PBO	534
<b>TABLE 364</b> Pain VAS: population 1 biologic vs. DMARD(s) or PBO	536
<b>TABLE 365</b> Pain VAS: populations 2 and 3 biologic head to head	538
<b>TABLE 366</b> Pain VAS: populations 2 and 3 biologic vs. DMARD(s) or PBO	539
<b>TABLE 367</b> 0–100 VAS of fatigue: population 1 RCTs of biologic vs. DMARD(s) or PBO	543
<b>TABLE 368</b> Functional Assessment of Chronic Illness Therapy – Fatigue score (0–52, higher scores indicate less fatigue): population 1 RCTs of biologic vs. DMARD(s) or PBO	543
<b>TABLE 369</b> The 0–100 VAS of fatigue: populations 2 and 3 biologic head-to-head RCTs	544
<b>TABLE 370</b> Functional Assessment of Chronic Illness Therapy – Fatigue score (0–52, higher scores indicate less fatigue): populations 2 and 3 biologic head-to-head RCTs	544
<b>TABLE 371</b> The 0–100 VAS of fatigue: populations 2 and 3 RCTs of biologic vs. DMARD(s) or PBO	544
<b>TABLE 372</b> Functional Assessment of Chronic Illness Therapy – Fatigue score (0–52, higher scores indicate less fatigue): populations 2 and 3 RCTs of biologic vs. DMARD(s) or PBO	545
<b>TABLE 373</b> The 0–100 SF-36 components scores: population 1 RCTs of biologic vs. DMARD(s) or PBO	546
<b>TABLE 374</b> The 0–100 SF-36 domains scores: baseline and follow-up – population 1 RCTs of biologic vs. DMARD(s) or PBO	548
<b>TABLE 375</b> The 0–100 SF-36 domains scores: mean change from baseline – population 1 RCTs of biologic vs. DMARD(s) or PBO	550
<b>TABLE 376</b> The 0–100 Short Form questionnaire-12 items components scores: population 1 RCTs of biologic vs. DMARD(s) or PBO	551
<b>TABLE 377</b> The 0–100 SF-6D and RAQoL: population 1 RCTs of biologic vs. DMARD(s) or PBO	552

<b>TABLE 378</b> The 0–100 EQ-5D: population 1 RCTs of biologic vs. DMARD(s) or PBO	<b>553</b>
<b>TABLE 379</b> The 0–100 SF-36 components scores: populations 2 and 3 biologic head-to-head RCTs	<b>554</b>
<b>TABLE 380</b> The 0–100 SF-36 domains scores: mean change from baseline – populations 2 and 3 biologic head-to-head RCTs	<b>555</b>
<b>TABLE 381</b> The 0–100 EQ-5D utility score: populations 2 and 3 biologic head-to-head RCTs	<b>555</b>
<b>TABLE 382</b> The 0–100 SF-36 components scores: populations 2 and 3 RCTs of biologic vs. DMARD(s) or PBO	<b>556</b>
<b>TABLE 383</b> The 0–100 SF-36 domains scores: baseline and follow-up – populations 2 and 3 RCTs of biologic vs. DMARD(s) or PBO	<b>558</b>
<b>TABLE 384</b> The 0–100 SF-36 domains scores: mean change from baseline – populations 2 and 3 RCTs of biologic vs. DMARD(s) or PBO	<b>560</b>
<b>TABLE 385</b> The 0–100 EQ-5D: populations 2 and 3 RCTs of biologic vs. DMARD(s) or PBO	<b>561</b>
<b>TABLE 386</b> The 0–100 EQ-5D domains scores: mean change form baseline – populations 2 and 3 RCTs of biologic vs. DMARD(s) or PBO	<b>562</b>
<b>TABLE 387</b> The 0–100 EuroQol VAS scores: populations 2 and 3 RCTs of biologic vs. DMARD(s) or PBO	<b>562</b>
<b>TABLE 388</b> Adverse events and discontinuations due to AEs: population 1 RCTs of biologic interventions vs. DMARD(s) or PBO	<b>563</b>
<b>TABLE 389</b> Adverse events and discontinuations due to AEs: populations 2 and 3 head-to-head biologic RCTs	<b>571</b>
<b>TABLE 390</b> Adverse events and discontinuations due to AEs: populations 2 and 3 RCTs of biologic interventions vs. DMARD(s) or PBO	<b>574</b>
<b>TABLE 391</b> Specific categories of AEs: population 1 RCTs of biologic interventions vs. DMARD(s) or PBO	<b>587</b>
<b>TABLE 392</b> Specific categories of AEs: populations 2 and 3 head-to-head biologic RCTs	<b>590</b>
<b>TABLE 393</b> Specific categories of AEs: populations 2 and 3 RCTs of biologic interventions vs. DMARD(s) or PBO	<b>592</b>
<b>TABLE 394</b> Number of deaths: population 1 RCTs biologic vs. cDMARD(s) or PBO	<b>602</b>
<b>TABLE 395</b> Number of deaths: populations 2 and 3 head-to-head biologic RCTs	<b>604</b>
<b>TABLE 396</b> Number of deaths: populations 2 and 3 RCTs biologic vs. cDMARD(s) or PBO	<b>605</b>





# List of figures

<b>FIGURE 1</b> Summary of the position of bDMARDs within NICE TA recommendations for sequence of treatments for patients with RA and a DAS28 > 5.1	<b>4</b>
<b>FIGURE 2</b> Flow diagram of study inclusion (adapted from PRISMA)	<b>21</b>
<b>FIGURE 3</b> Risk-of-bias graph	<b>26</b>
<b>FIGURE 4</b> American College of Rheumatology (population 1: main trials) – network of evidence	<b>70</b>
<b>FIGURE 5</b> American College of Rheumatology (population 1: main trials) – effects of interventions relative to cDMARDs on the probit scale	<b>71</b>
<b>FIGURE 6</b> American College of Rheumatology (population 1: main trials) – probability of treatment rankings in terms of efficacy (most efficacious = 1)	<b>72</b>
<b>FIGURE 7</b> American College of Rheumatology (population 1: main trials + MTX experienced) – network of evidence	<b>74</b>
<b>FIGURE 8</b> American College of Rheumatology (population 1: main trials + MTX experienced) – effects of interventions relative to cDMARDs on the probit scale	<b>75</b>
<b>FIGURE 9</b> American College of Rheumatology (population 1: main trials + MTX experienced) – probability of treatment rankings in terms of efficacy (most efficacious = 1)	<b>76</b>
<b>FIGURE 10</b> European League Against Rheumatism (populations 2 and 3: main trials) – network of evidence	<b>78</b>
<b>FIGURE 11</b> European League Against Rheumatism (populations 2 and 3: main trials) – effects of interventions relative to cDMARDs on the probit scale	<b>80</b>
<b>FIGURE 12</b> European League Against Rheumatism (populations 2 and 3: main trials) – probability of treatment rankings in terms of efficacy (most efficacious = 1)	<b>82</b>
<b>FIGURE 13</b> European League Against Rheumatism (populations 2 and 3: main trials + prior biologics) – network of evidence	<b>84</b>
<b>FIGURE 14</b> European League Against Rheumatism (populations 2 and 3: main trials + prior biologics) – effects of interventions relative to cDMARDs on the probit scale	<b>86</b>
<b>FIGURE 15</b> European League Against Rheumatism (populations 2 and 3: main trials + prior biologics) – probability of treatment rankings in terms of efficacy (most efficacious = 1)	<b>88</b>
<b>FIGURE 16</b> American College of Rheumatology (populations 2 and 3: main trials) – network of evidence	<b>91</b>

<b>FIGURE 17</b> American College of Rheumatology (populations 2 and 3: main trials) – effects of interventions relative to cDMARDs on the probit scale	<b>93</b>
<b>FIGURE 18</b> American College of Rheumatology (populations 2 and 3: main trials) – probability of treatment rankings in terms of efficacy (most efficacious = 1)	<b>95</b>
<b>FIGURE 19</b> American College of Rheumatology (populations 2 and 3: main trials + prior biologics with AMBITION) – network of evidence	<b>98</b>
<b>FIGURE 20</b> American College of Rheumatology (populations 2 and 3: main trials + prior biologics with AMBITION) – effects of interventions relative to cDMARDs on the probit scale	<b>100</b>
<b>FIGURE 21</b> American College of Rheumatology (populations 2 and 3: main trials + prior biologics with AMBITION) – probability of treatment rankings in terms of efficacy (most efficacious = 1)	<b>104</b>
<b>FIGURE 22</b> American College of Rheumatology (populations 2 and 3: main trials + prior biologics without AMBITION) – network of evidence	<b>107</b>
<b>FIGURE 23</b> American College of Rheumatology (populations 2 and 3: main trials + prior biologics without AMBITION) – effects of interventions relative to cDMARDs on the probit scale	<b>109</b>
<b>FIGURE 24</b> American College of Rheumatology (populations 2 and 3: main trials + prior biologics without AMBITION) – probability of treatment rankings in terms of efficacy (most efficacious = 1)	<b>112</b>
<b>FIGURE 25</b> American College of Rheumatology (populations 2 and 3: main trials + RCTs that have potentially low prior MTX exposure) – network of evidence	<b>116</b>
<b>FIGURE 26</b> American College of Rheumatology (populations 2 and 3: main trials + RCTs that have potentially low prior MTX exposure) – effects of interventions relative to cDMARDs on the probit scale	<b>118</b>
<b>FIGURE 27</b> American College of Rheumatology (populations 2 and 3: main trials + RCTs that have potentially low prior MTX exposure) – probability of treatment rankings in terms of efficacy (most efficacious = 1)	<b>120</b>
<b>FIGURE 28</b> Quality of reporting of meta-analyses flow diagram	<b>127</b>
<b>FIGURE 29</b> The number of pages in each submission (including appendices)	<b>134</b>
<b>FIGURE 30</b> Strategies modelled by Roche for analysis 8	<b>140</b>
<b>FIGURE 31</b> The AbbVie model structure	<b>142</b>
<b>FIGURE 32</b> The Bristol-Myers Squibb model structure	<b>144</b>
<b>FIGURE 33</b> The MSD model structure	<b>145</b>
<b>FIGURE 34</b> The Pfizer model structure	<b>145</b>

<b>FIGURE 35</b> Markov structure: severe disease activity population; model structure based on ACR response presented by UCB Pharma	146
<b>FIGURE 36</b> Markov structure: moderate disease activity population; model structure based on EULAR response presented by UCB Pharma	146
<b>FIGURE 37</b> The evidence network in AbbVie's base case	173
<b>FIGURE 38</b> Posterior simulated ACR response for combination therapy in a MTX-experienced population presented by AbbVie	174
<b>FIGURE 39</b> Posterior simulated ACR response for monotherapy in a MTX-experienced population presented by AbbVie	174
<b>FIGURE 40</b> Posterior simulated ACR response for combination therapy in a MTX-naive population presented by AbbVie	175
<b>FIGURE 41</b> Posterior simulated ACR response for monotherapy in a MTX-naive population presented by AbbVie	175
<b>FIGURE 42</b> The network of evidence for HAQ scores as supplied by Bristol-Myers Squibb	176
<b>FIGURE 43</b> The mean change in HAQ scores relative to PBO as estimated by Bristol-Myers Squibb	177
<b>FIGURE 44</b> The mean absolute change in HAQ scores as estimated by Bristol-Myers Squibb	177
<b>FIGURE 45</b> The probability of being the most efficacious treatment (on HAQ score) as estimated by Bristol-Myers Squibb	178
<b>FIGURE 46</b> The relationship assumed by Bristol-Myers Squibb between HAQ scores and DASs	178
<b>FIGURE 47</b> The mean change in DAS relative to PBO as estimated by Bristol-Myers Squibb	179
<b>FIGURE 48</b> The mean absolute change in DAS as estimated by Bristol-Myers Squibb	179
<b>FIGURE 49</b> The probability of being the most efficacious treatment (on DAS) as estimated by Bristol-Myers Squibb	180
<b>FIGURE 50</b> The network for DMARD-experienced patients as supplied by MSD	180
<b>FIGURE 51</b> American College of Rheumatology 20: DMARD-experienced patients at 24 weeks estimated by MSD in the GOL submission	181
<b>FIGURE 52</b> American College of Rheumatology 50: DMARD-experienced patients at 24 weeks estimated by MSD in the GOL submission	181
<b>FIGURE 53</b> American College of Rheumatology 70: DMARD-experienced patients at 24 weeks estimated by MSD in the GOL submission	181

<b>FIGURE 54</b> American College of Rheumatology 20: DMARD-experienced patients at 24 weeks estimated by MSD in the IFX submission	<b>182</b>
<b>FIGURE 55</b> American College of Rheumatology 50: DMARD-experienced patients at 24 weeks estimated by MSD in the IFX submission	<b>182</b>
<b>FIGURE 56</b> American College of Rheumatology 70: DMARD-experienced patients at 24 weeks estimated by MSD in the IFX submission	<b>182</b>
<b>FIGURE 57</b> Comparison of MTX usage (average mg/week) in East Asian vs. non-East Asian studies supplied by MSD	<b>183</b>
<b>FIGURE 58</b> The network diagram for combination therapy, ACR responses in severe DMARD-experienced patients as produced by Pfizer	<b>184</b>
<b>FIGURE 59</b> The network diagram for combination therapy, HAQ changes in severe DMARD-experienced patients as produced by Pfizer	<b>184</b>
<b>FIGURE 60</b> The network diagram for monotherapy, ACR responses in severe DMARD-experienced patients as produced by Pfizer	<b>184</b>
<b>FIGURE 61</b> The network of studies included in the meta-analysis undertaken by Roche	<b>186</b>
<b>FIGURE 62</b> Biologic monotherapy ACR responses used in the model submitted by Roche	<b>187</b>
<b>FIGURE 63</b> Academic-in-confidence information has been removed	<b>187</b>
<b>FIGURE 64</b> Academic-in-confidence information has been removed	<b>187</b>
<b>FIGURE 65</b> Academic-in-confidence information has been removed	<b>187</b>
<b>FIGURE 66</b> Academic-in-confidence information has been removed	<b>187</b>
<b>FIGURE 67</b> Academic-in-confidence information has been removed	<b>187</b>
<b>FIGURE 68</b> Academic-in-confidence information has been removed	<b>187</b>
<b>FIGURE 69</b> Academic-in-confidence information has been removed	<b>188</b>
<b>FIGURE 70</b> Academic-in-confidence information has been removed	<b>188</b>
<b>FIGURE 71</b> Kaplan–Meier estimates of the observed persistence with all antiTNFs and with the combination therapy of antiTNFs and MTX in BSRBR	<b>198</b>
<b>FIGURE 72</b> Commercial-in-confidence information has been removed	<b>202</b>
<b>FIGURE 73</b> The fitted log-logistic survival distributions estimated by Pfizer	<b>202</b>
<b>FIGURE 74</b> Commercial-in-confidence information has been removed	<b>202</b>

<b>FIGURE 75</b> Conditional inference tree of first-line treatment cessation, showing patterns of treatment cessation within the economic model, (left to right) shortest to longest times presented by Pfizer	203
<b>FIGURE 76</b> Treatment cessation in second and subsequent lines estimated by Pfizer	203
<b>FIGURE 77</b> The Weibull and exponential model fitted by Roche to data from Soliman <i>et al.</i>	205
<b>FIGURE 78</b> A summation of the hospital costs (annual) assumed associated with each HAQ band	206
<b>FIGURE 79</b> The relationship between HAQ and utility assumed in the manufacturers' models	209
<b>FIGURE 80</b> Odds ratio of discontinuations due to AEs in cDMARD-experienced patients assumed by MSD	215
<b>FIGURE 81</b> An illustrative mortality survival curve presented by AbbVie for males	218
<b>FIGURE 82</b> An illustrative mortality survival curve presented by AbbVie for females	218
<b>FIGURE 83</b> The general mortality rate for females assumed by UCB Pharma, with an exponential fit to these data points	220
<b>FIGURE 84</b> The general mortality rate for males assumed by UCB Pharma, with an exponential fit to these data points	221
<b>FIGURE 85</b> Cost-effectiveness acceptability curve for analysis 1 provided by AbbVie	224
<b>FIGURE 86</b> Cost-effectiveness acceptability curve for analysis 2 provided by AbbVie	224
<b>FIGURE 87</b> Cost-effectiveness acceptability curve for analysis 3 provided by AbbVie	225
<b>FIGURE 88</b> Cost-effectiveness acceptability curve for analysis 4 provided by AbbVie	225
<b>FIGURE 89</b> Cost-effectiveness acceptability curve for analysis 5 provided by AbbVie	226
<b>FIGURE 90</b> Cost-effectiveness acceptability curve for analysis 6 provided by AbbVie	227
<b>FIGURE 91</b> Commercial-in-confidence information has been removed	228
<b>FIGURE 92</b> Cost-effectiveness acceptability curve for all bDMARDs for analysis 7 within the MSD GOL submission	229
<b>FIGURE 93</b> Cost-effectiveness acceptability curve for all bDMARDs for analysis 7 within the MSD IFX submission	231
<b>FIGURE 94</b> Cost-effectiveness acceptability curve for analysis 1 within the Pfizer submission	232
<b>FIGURE 95</b> Cost-effectiveness acceptability curve for analysis 2 within the Pfizer submission	232

<b>FIGURE 96</b> Cost-effectiveness acceptability curve for analysis 3 within the Pfizer submission	232
<b>FIGURE 97</b> Cost-effectiveness acceptability curve for analysis 4 within the Pfizer submission	232
<b>FIGURE 98</b> The CEAC produced by Roche for analysis 8	234
<b>FIGURE 99</b> Base-case CEAC for analysis 1 produced by UCB Pharma	235
<b>FIGURE 100</b> Base-case CEAC for analysis 4 produced by UCB Pharma	236
<b>FIGURE 101</b> Conceptual simplified schematic of the modelling process	241
<b>FIGURE 102</b> Estimated mean EULAR responses in cDMARD-experienced patients (main analyses)	244
<b>FIGURE 103</b> Estimated mean EULAR responses in cDMARD-experienced patients (main analyses + RCTs with a small level of bDMARD use)	245
<b>FIGURE 104</b> Estimated mean EULAR response in cDMARD-experienced mapped patients from ACR trials (main analyses)	245
<b>FIGURE 105</b> Estimated mean EULAR response in cDMARD-experienced mapped patients from ACR trials (main analyses + RCTs with a small level of bDMARD use)	246
<b>FIGURE 106</b> Estimated mean EULAR response in cDMARD-experienced patients mapped from ACR trials (main analyses + RCTs with a small level of bDMARD use and also allowing a trial with low MTX background use)	246
<b>FIGURE 107</b> Estimated mean EULAR response in cDMARD-experienced patients mapped from ACR trials (main analyses + RCTs with low MTX background use)	247
<b>FIGURE 108</b> Estimated mean EULAR response in cDMARD-experienced patients mapped from ACR trials in cDMARD-naïve patients	247
<b>FIGURE 109</b> Estimated mean EULAR response in cDMARD-experienced patients mapped from ACR trials in cDMARD-naïve patients including RCTs with a proportion of cDMARD-experienced patients	248
<b>FIGURE 110</b> Mean HAQ by EULAR response category for those receiving bDMARDs	251
<b>FIGURE 111</b> Academic-in-confidence information has been removed	255
<b>FIGURE 112</b> Plots of the estimated data from the statistical models compared with the observed data	258
<b>FIGURE 113</b> The assumed relationship between annual hospitalisation costs and HAQ score in the Assessment Group model	260
<b>FIGURE 114</b> The relationship between HAQ score and pain value	261
<b>FIGURE 115</b> A comparison of published relationships between utility and HAQ	263

<b>FIGURE 116</b> Evaluating the number of patients required in analyses involving patients with severe RA who could receive MTX	265
<b>FIGURE 117</b> Evaluating the number of patients required in analyses involving patients with moderate RA who could receive MTX	265
<b>FIGURE 118</b> Discounted cost per QALY of a bDMARD strategy compared with a non-bDMARD strategy in a cDMARD-naive population	266
<b>FIGURE 119</b> The CEAC when using EULAR data directly: ERAS cDMARD HAQ progression and a severe, MTX-experienced, RA population	274
<b>FIGURE 120</b> The CEAC using EULAR data directly and assuming linear CDMARD HAQ progression	278
<b>FIGURE 121</b> The CEAC when using ACR data mapped to EULAR data: ERAS cDMARD HAQ progression and a severe, MTX-experienced, RA population	283
<b>FIGURE 122</b> The CEAC using ACR data mapped to EULAR data and assuming linear CDMARD HAQ progression	288
<b>FIGURE 123</b> The CEAC when using EULAR data directly: ERAS cDMARD HAQ progression and a moderate, MTX-experienced, RA population	292
<b>FIGURE 124</b> The CEAC using EULAR data directly and assuming linear CDMARD HAQ progression and a moderate, MTX-experienced, RA population	296
<b>FIGURE 125</b> The CEAC when using ACR data mapped to EULAR data: ERAS cDMARD HAQ progression and a moderate, MTX-experienced, RA population	301
<b>FIGURE 126</b> The CEAC using ACR data mapped to EULAR data and assuming linear CDMARD HAQ progression and a moderate, MTX-experienced, RA population	307
<b>FIGURE 127</b> The CEAC when using EULAR data directly: ERAS cDMARD HAQ progression and a severe, MTX-experienced, RA population treated with monotherapy	310
<b>FIGURE 128</b> The CEAC when using EULAR data directly: linear cDMARD HAQ progression and a severe, MTX-experienced, RA population treated with monotherapy	313
<b>FIGURE 129</b> The CEAC when mapping EULAR data from ACR data: ERAS cDMARD HAQ progression and a severe, MTX-experienced, RA population treated with monotherapy	316
<b>FIGURE 130</b> The CEAC when mapping EULAR data from ACR data: linear cDMARD HAQ progression and a severe, MTX-experienced, RA population treated with monotherapy	320
<b>FIGURE 131</b> The CEAC when using EULAR data directly: ERAS cDMARD HAQ progression and a moderate, MTX-experienced, RA population treated with monotherapy	323

<b>FIGURE 132</b> The CEAC when using EULAR data directly: linear cDMARD HAQ progression and a severe, MTX-experienced, RA population treated with monotherapy	<b>326</b>
<b>FIGURE 133</b> The CEAC when mapping EULAR data from ACR data: ERAS cDMARD HAQ progression and a moderate, MTX-experienced, RA population treated with monotherapy	<b>330</b>
<b>FIGURE 134</b> The CEAC when mapping EULAR data from ACR data: linear cDMARD HAQ progression and a moderate, MTX-experienced, RA population treated with monotherapy	<b>333</b>
<b>FIGURE 135</b> The CEAC when mapping EULAR data from ACR data: ERAS cDMARD HAQ progression and a severe, MTX-naive, RA population treated	<b>335</b>
<b>FIGURE 136</b> The CEAC when mapping EULAR data from ACR data: linear cDMARD HAQ progression and a severe, MTX-naive, RA population	<b>338</b>
<b>FIGURE 137</b> The CEAC when mapping EULAR data from ACR data: ERAS cDMARD HAQ progression and a severe, MTX-naive, RA population treated with monotherapy	<b>340</b>
<b>FIGURE 138</b> The CEAC when mapping EULAR data from ACR data: linear cDMARD HAQ progression and a severe, MTX-naive, RA population	<b>342</b>



# List of boxes

<b>BOX 1</b> Eligibility criteria	<b>126</b>
<b>BOX 2</b> The individual simulation process reported by Roche	<b>145</b>



## List of abbreviations

ABT	abatacept	cDMARD	conventional disease-modifying antirheumatic drug
ACR	American College of Rheumatology		
ACT-RAY	ACTemra (tocilizumab) RAdiographic study	CEAC	cost-effectiveness acceptability curve
ADA	adalimumab	CERTAIN	efficacy and safety of CERTolizumab pegol After INcomplete response to DMARDS in RA patients with low to moderate disease activity
ADACTA	ADalimumab ACTemra (tocilizumab) head-to-head study		
ADORE	ADjuvant Oxaliplatin in REctal Cancer	CG	clinical guideline
AE	adverse event	CI	confidence interval
AiC	academic-in-confidence	CiC	commercial-in-confidence
AMBITION	Actemra versus Methotrexate double Blind Investigative Trial In mONotherapy	CINAHL	Cumulative Index to Nursing and Allied Health Literature
AMPLE	abatacept vs. adalimumab in biologic naive RA patients with background MTX	COMET	Combination Of METHotrexate and etabercept in early rheumatoid arthritis
APPEAL	Asia-Pacific Study in Patients to be Treated With Etanercept or an Alternative Listed	CrI	credible interval
ARMADA	Anti-TNF factor Research study program of the Monoclonal antibody ADalimumab (D2E7) in rheumatoid Arthritis	CRP	C-reactive protein
		CTZ	certolizumab pegol
		CYC	ciclosporin
		DAS	Disease Activity Score
		DAS28	Disease Activity Score 28 joints
ATTEST	A Trial for Tolerability, Efficacy, and Safety in Treating rheumatoid arthritis (infliximab)	DAS28-CRP	Disease Activity Score 28 C-reactive protein
		DAS28-ESR	Disease Activity Score 28 erythrocyte sedimentation rate
ATTRACT	Anti-TNF trial in Rheumatoid Arthritis with Concomitant Therapy	DE019	Efficacy and Safety of Adalimumab in Patients With Active Rheumatoid Arthritis Treated Concomitantly With Methotrexate
AUGUST II	A Phase II Dose-finding Study of Atacept in Rheumatoid Arthritis (RA)		
AZA	azathioprine	DES	discrete event simulation
bDMARD	biologic disease-modifying antirheumatic drug	DMARD	disease-modifying antirheumatic drug
BeST	BEhandelings STRategie		
BMJ	<i>British Medical Journal</i>	EQ-5D	European Quality of Life-5 Dimensions
BSRBR	British Society for Rheumatology Biologics Register	ERAS	Early Rheumatoid Arthritis Study

## LIST OF ABBREVIATIONS

ESR	erythrocyte sedimentation rate	LTE	long-term extension
ETN	etanercept	MP	methylprednisolone
EULAR	European League Against Rheumatism	MSD	Merck Sharp & Dohme Corp.
FACIT-F	Functional Assessment of Chronic Illness Therapy – Fatigue	MTX	methotrexate
FDA	Food and Drug Administration	NBT	non-biologic therapy
GLD	gold injection	NDB	National Data Bank for Rheumatic Diseases
GO-BEFORE	Golimumab in active rheumatoid arthritis BEFORE methotrexate therapy	NICE	National Institute for Health and Care Excellence
GO-FORTH	golimumab in combination with methotrexate in Japanese patients with active rheumatoid arthritis	NMA	network meta-analysis
GO-FORWARD	golimumab in active rheumatoid arthritis despite methotrexate therapy	NOAR	Norfolk Arthritis Register
GOL	golimumab	NSAID	non-steroidal anti-inflammatory drug
GP	general practitioner	OMERACT	Outcome Measures in Rheumatoid Arthritis Clinical Trials
GUEPARD	GUÉrir la PolyARthrite rheumatoïde Débutante (adalimumab)	OPERA	OPTimized treatment algorithm for patients with Early Rheumatoid Arthritis
HAQ	Health Assessment Questionnaire	OPTION	tOcilimumab Pivotal Trial In methotrexate inadequate respONders
HAQ-DI	Health Assessment Questionnaire Disability Index	PAS	Patient Access Scheme
HCQ	hydroxychloroquine	PBO	placebo
HR	hazard ratio	PREMIER	Patients REceiving Methotrexate and Infliximab for the treatment of Early Rheumatoid arthritis
HTA	Health Technology Assessment	PRISMA	Preferred Reporting Items for Systematic Reviews and Meta-Analyses
ICER	incremental cost-effectiveness ratio	PSA	probabilistic sensitivity analysis
IFX	infliximab	QALY	quality-adjusted life-year
i.v.	intravenous	RA	rheumatoid arthritis
JESMR	Japanese Efficacy and Safety of Etanercept on Active Rheumatoid Arthritis Despite Methotrexate Therapy	RACAT	Rheumatoid Arthritis Comparison of Active Therapies in Methotrexate Suboptimal Responders study
LARA	Latin American Rheumatoid Arthritis study	RAPID	Rheumatoid Arthritis Prevention of structural Damage
LEF	leflunomide	RAQoL	Rheumatoid Arthritis Quality of Life
LITHE	tocilizumab safety and the prevention of structural joint damage methotrexate and sulfasalazine combination trial	RCT	randomised controlled trial

RED-SEA	a Randomised Efficacy and Discontinuation Study of Etanercept versus Adalimumab	TA	technology appraisal
RTX	rituximab	TACIT	tumour necrosis factor inhibitors against combination intensive therapy
SAMURAI	Study of Active controlled Monotherapy Used for Rheumatoid Arthritis, an IL-6 Inhibitor	TCZ	tocilizumab
s.c.	subcutaneous	TEAR	Treatment of Early Aggressive Rheumatoid arthritis
SCHARR	School of Health and Related Research	TEMPO	Trial of Etanercept and Methotrexate with Radiographic Patient Outcomes
SD	standard deviation	TNF	tumour necrosis factor
SE	standard error	TNF- $\alpha$	tumour necrosis factor alpha
SF-36	Short Form questionnaire-36 items	TOF	tofacitinib
SF-6D	Short Form questionnaire-6 Dimensions	TOWARD	TOcilizumab in combination With traditional DMARD therapy
SSZ	sulfasalazine	VARA	Veterans Affairs Rheumatoid Arthritis
START	Safety Trial for rheumatoid Arthritis with Remicade Therapy	VAS	visual analogue scale
Swefot	Swedish pharmacotherapy		

## Note

This monograph is based on the Technology Assessment Report produced for NICE. The full report contained a considerable number of data that were deemed commercial-in-confidence and/or academic-in-confidence. The full report was used by the Appraisal Committee at NICE in their deliberations. The full report with each piece of commercial-in-confidence and/or academic-in-confidence data removed and replaced by the statement 'commercial-in-confidence and/or academic-in-confidence information (or data) removed' is available on the NICE website: [www.nice.org.uk](http://www.nice.org.uk).

The present monograph presents as full a version of the report as is possible while retaining readability, but some sections, sentences, tables and figures have been removed. Readers should bear in mind that the discussion, conclusions and implications for practice and research are based on all the data considered in the original full NICE report.



# Plain English summary

## Review question

The clinical effectiveness and cost-effectiveness of biologic disease-modifying antirheumatic drugs (bDMARDs) compared with conventional disease-modifying antirheumatic drugs (cDMARDs) in individuals with rheumatoid arthritis was assessed.

## Background

Rheumatoid arthritis is associated with significant morbidity. bDMARDs are more efficacious than cDMARDs, but are considerably more expensive.

## Work undertaken

A systematic review of randomised controlled trials of efficacy was undertaken. Network meta-analyses were undertaken to ensure coherent results regarding efficacy. Interrogation of an observational database was performed to provide data on disease progression when treated with cDMARDs. A mathematical model was constructed to estimate the incremental cost per quality-adjusted life-year (QALY).

## Key results

Fifty-two clinical trials provided data on American College of Rheumatology and/or European League Against Rheumatism responses for bDMARDs (38 in the main analyses and 14 for sensitivity analyses). These data were synthesised to produce coherent results. bDMARDs were shown to be more effective than cDMARDs. The interrogation of the database indicated that historical assumptions regarding disease progression while on cDMARDs were far too pessimistic. Results from the cost-effectiveness analyses indicated typical cost per QALY of  $\geq$  £40,000. These are higher than values reported by the National Institute for Health and Care Excellence as thresholds for an intervention to be considered cost-effective.





# Scientific summary

## Background

Rheumatoid arthritis (RA) is a chronic inflammatory disease characterised by progressive, irreversible, joint damage, impaired joint function, and pain and tenderness caused by swelling of the synovial lining of joints and results in increasing disability and reduced quality of life. The primary symptoms are pain, morning stiffness, swelling, tenderness, loss of movement, fatigue and redness of the peripheral joints. RA is associated with substantial costs, both direct (associated with drug acquisition and hospitalisation) and indirect (owing to reduced productivity).

In 2010 the American College of Rheumatology (ACR) and the European League Against Rheumatism (EULAR) jointly published Rheumatoid Arthritis Classification Criteria, which focused on features at earlier stages of disease that are associated with persistent and/or erosive disease rather than defining the disease by its late-stage features. The classification criteria allocate scores to characteristics of joint involvement, serology, acute-phase reactants and duration of symptoms, to produce a score between 0 and 10, inclusive, with those scoring  $\geq 6$  and with obvious clinical synovitis being defined as having 'definite RA' in the absence of an alternative diagnosis that better explains the synovitis.

There are an estimated 400,000 people in England and Wales with RA, and approximately 10,000 incident cases per year. The disease is more common in females (1.16%) than in males (0.44%), with the majority of cases being diagnosed when patients are aged between 40 and 80 years and with peak incidence in patients in their seventies.

## Objectives

The key objectives of this report are twofold: to estimate the clinical effectiveness of seven biologic disease-modifying antirheumatic drugs (bDMARDs) – adalimumab (ADA; Humira<sup>®</sup>, AbbVie), etanercept (ETN; Enbrel<sup>®</sup>, Pfizer), infliximab [IFX; Remicade<sup>®</sup>, Merck Sharp & Dohme Corp. (MSD)], certolizumab pegol (CTZ; Cimzia<sup>®</sup>, UCB Pharma), golimumab (GOL; Simponi<sup>®</sup>, MSD), tocilizumab (TCZ; RoActemra<sup>®</sup>, Roche) and abatacept (ABT; Orencia<sup>®</sup>, Bristol-Myers Squibb) – in defined populations; and to estimate the cost-effectiveness of these interventions compared with conventional disease-modifying antirheumatic drugs (cDMARDs). These analyses incorporated the use of bDMARDs with and without methotrexate (MTX) where this was within licence.

Three populations were defined: population 1, adults with severe active RA not previously treated with cDMARDs; population 2, adults with severe active RA that has been previously treated with cDMARDs but not bDMARDs; and population 3, adults with moderate to severe active RA that has been previously treated with cDMARDs only, including MTX (unless contraindicated or inappropriate).

## Methods

A systematic review of clinical effectiveness and safety evidence for interventions of interest was conducted. Where trials narrowly missed criteria (because of a small proportion of patients with prior bDMARD exposure or low prior MTX exposure), they were considered to inform sensitivity analyses. Separate network meta-analyses (NMAs) were undertaken for randomised controlled trials (RCTs) reporting EULAR and ACR data.

A mathematical model was constructed to simulate the experiences of hypothetical patients. The model was based on EULAR response data as these are most commonly used in clinical practice in England and Wales. Large observational databases, published literature and the results of the NMAs were used to provide data for the model. The primary outcome measure was incremental cost per quality-adjusted life-year (QALY) gained.

## Results

Sixty RCTs met the inclusion criteria for the systematic review of clinical effectiveness and safety evidence. Of these, 38 trials provided relevant ACR and EULAR response data for the NMA. In addition, 14 additional trials not meeting review criteria contributed data to NMA sensitivity analyses. Other relevant efficacy and safety outcomes were tabulated and discussed in a narrative synthesis. Generally, risk of bias was low overall, and low for baseline comparability, blinding, analysis by allocated treatment group and inclusion of  $\geq 80\%$  of participants randomised in the final analysis. There was greater risk of bias and a lack of clarity in many included trials for allocation sequence generation and concealment, and selective reporting of outcomes.

Although there was uncertainty in, and overlap between, the effects of treatment on ACR for interventions for patients in population 1, IFX plus MTX was associated with the biggest increase in response rate and this was likely to be the most effective intervention. Other interventions were less effective and appeared to fall into three groups: (1) intensive cDMARDs and ADA plus MTX; (2) ETN, GOL plus MTX and step-up combination cDMARDs; and (3) ADA and cDMARDs.

Although there was uncertainty in, and overlap between, the effects of treatment on EULAR for interventions in populations 2 and 3 in the main trials, ETN plus MTX and TCZ plus MTX were associated with the biggest increase in response rate. Other interventions were less effective and appeared to fall into two groups: (1) TCZ, GOL plus MTX, ADA plus MTX, ABT intravenous (i.v.) plus MTX and grouped biologics; and (2) ETN, IFX plus MTX, ADA and intensive cDMARDs. The inclusion of the additional studies in which patients received prior biologics resulted in broadly the same groupings, although CTZ plus MTX was associated with an even bigger response than ETN plus MTX and TCZ plus MTX.

Although there was uncertainty in, and overlap between, the effects of treatment on ACR for interventions in populations 2 and 3 in the main trials, ETN plus MTX, TCZ and TCZ plus MTX were associated with the biggest increase in response rate. Other interventions were less effective and appeared to fall into two groups: (1) ETN, GOL plus MTX, ABT subcutaneous plus MTX, ADA plus MTX, IFX plus MTX and ABT i.v. plus MTX; and (2) CTZ plus MTX, intensive cDMARDs and ADA. The inclusion of the additional studies in which patients received prior biologics suggested that CTZ plus MTX and ETN plus MTX resulted in the highest response rates. Other interventions appeared to give rise to broadly similar and slightly smaller response rates except for intensive cDMARDs and ADA which are associated with even smaller response rates.

The incremental cost per QALY of bDMARDs compared with a cDMARD-alone strategy is typically £40,000 when used in populations 2 and 3 and is greater in individuals with moderate to severe disease. The incremental cost per QALY increases (£50,000) for those who receive a bDMARD without MTX and is approximately £60,000 in population 1. A key parameter that affected the results is the assumed Health Assessment Questionnaire (HAQ) while on cDMARDs; if the values used in previous National Institute for Health and Care Excellence (NICE) appraisals were instead used, the incremental cost per QALY fell to approximately £38,000 for bDMARDs compared with cDMARDs alone. Fully incremental analyses were undertaken, but these could be misleading owing to the similarity in incremental costs per QALY for each bDMARD compared with cDMARDs alone, and the uncertainty in efficacy parameters. The data source used for establishing the relationship between HAQ and pain was also seen to influence the results markedly; the Assessment Group base case uses the estimate most favourable to the bDMARDs.

## Discussion

There is no reason to believe that the results detailed in this report are not generalisable to the English and Welsh populations.

A strength of this report is that a systematic review of RCTs for bDMARDs in bDMARD-naive patients has been conducted. The primary outcome measures are EULAR or ACR response at 6 months and a formal NMA has been conducted to assess relative efficacy. Different analyses have been undertaken to assess the impact of including RCTs with a small proportion on patients with prior bDMARD use, and/or including RCTs when patients may have not had adequate prior MTX treatment.

A major strength of the cost-effectiveness analyses presented is that the Assessment Group has constructed a EULAR-based model that is much more appropriate to practice in England and Wales than previous ACR-based models. Estimates of incremental cost-effectiveness ratios (ICERs) for both EULAR data only, and when mapping ACR data to EULAR data indicate that the conclusions were not altered by restricting the selection of RCTs to only those that reported EULAR data.

An additional strength is that large observational databases were used to generate data on parameters such as HAQ change conditional on EULAR response and HAQ progression while on cDMARDs. This is preferable to data taken from relatively small RCTs of limited follow-up.

The model has known limitations. The plausible reduced efficacy of treatments when used subsequent to other treatments has not been formally incorporated. It is expected that this omission will favour bDMARDs. Lost productivity has not been included in the model, which may favour bDMARDs if it were included.

The analyses have assumed that the discontinuation rule specified by NICE has been strictly adhered to; data from the British Society for Rheumatology Biologics Register show that this is not the case. If such non-adherence continues, the ICERs will be considerably higher than those presented. Analysis of the impact has not been undertaken due to the possibility of back-calculation of commercial-in-confidence discounts offered through Patient Access Schemes.

## Conclusions

The implications for the NHS are not known and it will be heavily dependent on the guidance produced by NICE.

Key research priorities include establishing, more precisely, HAQ progression while on cDMARDs; the relationship between HAQ score and utility; and the relationship between HAQ score and pain. Better evidence on the relative efficacies of bDMARDs and the reduction in efficacy when used after a different bDMARD would be beneficial, but it is acknowledged that large RCTs would be required to provide definitive answers.

## Study registration

This study is registered as PROSPERO CRD42012003386.

## Funding

Funding for this study was provided by the Health Technology Assessment programme of the National Institute for Health Research.



# Chapter 1 Background

## Description of health problem

### Aetiology

Rheumatoid arthritis (RA) is a chronic inflammatory disease characterised by progressive, irreversible, joint damage, impaired joint function, and pain and tenderness caused by swelling of the synovial lining of joints and is manifested with increasing disability and reduced quality of life.<sup>1</sup> The primary symptoms are pain, morning stiffness, swelling, tenderness, loss of movement, fatigue and redness of the peripheral joints.<sup>2,3</sup> RA is associated with substantial costs, both direct (associated with drug acquisition and hospitalisation) and indirect (owing to reduced productivity).<sup>4</sup> RA has long been reported as being associated with increased mortality,<sup>5,6</sup> particularly due to cardiovascular events.<sup>7</sup>

### Epidemiology

The initial classification criteria for RA were produced in 1987 by the American College of Rheumatology (ACR).<sup>8</sup> The National Institute for Health and Care Excellence (NICE) Clinical Guideline (CG) 79<sup>9</sup> provides a summary of the ACR criteria, namely that patients must have at least four of the seven criteria (morning stiffness lasting at least 1 hour; swelling in three or more joints; swelling in hand joints; symmetrical joint swelling; erosions or decalcification on radiograph of hand; rheumatoid nodules; and abnormal serum rheumatoid factor). The first four criteria must have been present for at least a period of 6 weeks. However, in the CG the guideline development group preferred a clinical diagnosis of RA rather than the ACR criteria because 'an early persistent synovitis where other pathologies have been ruled out needs to be treated as if it is RA to try to prevent damage to joints. Identification of persistent synovitis and appropriate early management is more important than whether the disease satisfies classification criteria', referencing the European League Against Rheumatism (EULAR) recommendations.<sup>10</sup>

In 2010 the ACR and EULAR jointly published Rheumatoid Arthritis Classification Criteria, which focused on features at earlier stages of disease that are associated with persistent and/or erosive disease rather than defining the disease by its late-stage features.<sup>11</sup> The classification criteria allocate scores to characteristics of joint involvement, serology, acute-phase reactants and duration of symptoms, to produce a score between 0 and 10, inclusive, with those scoring  $\geq 6$  and with obvious clinical synovitis being defined as having 'definite RA' in the absence of an alternative diagnosis that better explains the synovitis.

Two classifications have dominated the measurement of improvement in RA symptoms: (1) ACR responses;<sup>12</sup> and (2) EULAR responses.<sup>13</sup>

The initial ACR response was denoted as an ACR20, which required a 20% improvement in tender joint counts; a 20% improvement in swollen joint counts; and a 20% improvement in at least three of the following five 'core set items': physician global assessment; patient global assessment; patient pain; self-reported disability (using a validated instrument); and erythrocyte sedimentation rate (ESR)/C-reactive protein (CRP).

The ACR response has been widely adopted in randomised controlled trials (RCTs), although studies have shown that the value can vary between trials owing to the timing of the response.<sup>14</sup> Since the inception of the ACR20 two other response criteria (ACR50 and ACR70) have become more widely used, which are similar to ACR20 and differing only in the level of improvements required to be denoted a responder.

In the UK, monitoring the progression of RA is often undertaken using the Disease Activity Score 28 joints (DAS28). This assesses 28 joints in terms of swelling (SW28) and of tenderness to the touch (TEN28) and also incorporates measures of the ESR and a subjective assessment (SA) on a scale of 0–100 made by the patient regarding disease activity in the previous week.

The equation for calculating DAS28 is as follows:<sup>15</sup>

$$\text{DAS28} = 0.56 \times \text{TEN28}^{0.5} + 28 \times \text{SW28}^{0.5} + 0.70 \times \ln(\text{ESR}) + 0.014 \times \text{SA}. \quad (1)$$

The DAS28 can be used to classify both the disease activity of the patient and the level of improvement estimated within the patient.

The EULAR response criteria use the individual change in DAS28 and the level of DAS28 reached to classify trial participants as good, moderate or non-responders.<sup>13</sup> The EULAR response criteria and the ACR20 improvement criteria were found to have reasonable agreement in the same set of clinical trials,<sup>16</sup> although van Gestel *et al.*<sup>16</sup> state that the EULAR response criteria showed better construct and discriminant validity than did ACR20. EULAR response has been reported less frequently in RCTs than ACR responses, although EULAR is much more closely aligned to the treatment continuation rules stipulated by NICE, which require a DAS28 improvement of more than 1.2 to continue treatment. The relationship between change in DAS28 and the level of DAS28 reached with EULAR response is shown in *Table 1*. Dependent on the initial Disease Activity Score (DAS) score of the patient, this would equate to either a good or moderate EULAR response, as shown in the second column of *Table 1*.

Patients with a DAS28 of  $\leq 3.2$  are stated as having inactive disease, those with a DAS28 of  $> 3.2$  and  $\leq 5.1$  are stated as having moderate disease and those with a DAS28 of  $> 5.1$  are stated as having very active disease.<sup>15</sup>

A widely used measure of patient disability is the Health Assessment Questionnaire (HAQ). The HAQ is a patient-completed disability assessment<sup>17</sup> which has established reliability and validity and has been used in many published RCTs in RA. HAQ scores range from 0 to 3, with higher scores indicating greater disability. The HAQ is a discrete scale with step values of 0.125, resulting in 25 points on the HAQ scale.

### Incidence and prevalence

There are an estimated 400,000 people in England and Wales with RA,<sup>18</sup> with approximately 10,000 incident cases per year.<sup>19</sup> The disease is more common in females (1.16%) than in males (0.44%),<sup>19</sup> with the majority of cases being diagnosed when patients are aged between 40 and 80 years<sup>20</sup> and with peak incidence in patients in their seventies.<sup>19</sup> Traditionally, patients have been treated with conventional disease-modifying antirheumatic drugs (cDMARDs), which include methotrexate (MTX), sulfasalazine (SSZ), hydroxychloroquine (HCQ), leflunomide (LEF), and gold injections (GLDs) as well as corticosteroids, analgesics and non-steroidal anti-inflammatory drugs (NSAIDs). However, more recently, a group of drugs have been developed consisting of monoclonal antibodies and soluble receptors that specifically modify the disease process by blocking key protein messenger molecules (such as cytokines) or cells (such as B-lymphocytes).<sup>9</sup> Such drugs have been labelled as biologic disease-modifying antirheumatic drugs (bDMARDs) and form the focus of this report.

**TABLE 1** Determining EULAR response based on DAS28<sup>16</sup>

DAS28 at end point	Improvement in DAS28		
	> 1.2	> 0.6 and $\leq 1.2$	$\leq 0.6$
$\leq 3.2$	Good	Moderate	Non
$> 3.2$ and $\leq 5.1$	Moderate	Moderate	Non
$> 5.1$	Moderate	Non	Non

The shaded cells indicate where patients continue treatment based on current NICE technology appraisals guidance.

### Significance for the NHS

Owing to previous NICE technology appraisals (TAs) recommending a number of bDMARDs (see *Current service provision*), with a potential sequence of three bDMARDs, there has been a considerable increase in expenditure on RA interventions. Given the remit of this research to establish the clinical effectiveness and cost-effectiveness of bDMARDs in advance of cDMARDs for patients with less severe disease (assumed to be those with a DAS28 of between  $> 3.2$  and  $\leq 5.1$ ), there is potential for the expenditure to increase further should NICE guidance on these populations be positive. The majority of interventions are provided subcutaneously and would therefore require little additional staff time should there be positive guidance, although this would increase for those drugs which are given intravenously.

Further detailed information on the background of RA can be found within the relatively recent NICE CG.<sup>9</sup> Additional information can also be located in the British Society for Rheumatology guidelines.<sup>21</sup>

## Current service provision

### Clinical guidelines

For people with newly diagnosed RA, NICE CG79<sup>9</sup> recommends a combination of cDMARDs [including MTX and at least one other disease-modifying anti-rheumatic drug (DMARD) plus short-term glucocorticoids] as first-line treatment, ideally beginning within 3 months of the onset of persistent symptoms. Where combination therapies are not appropriate (e.g. where there are comorbidities or pregnancy), DMARD monotherapy is recommended. Where DMARD monotherapy is used emphasis should be on increasing the dose quickly to obtain best disease control. For the purposes of this assessment the term intensive DMARDs has been used to denote that this is treatment with multiple cDMARDs simultaneously.

### Current National Institute for Health and Care Excellence technology appraisal guidance

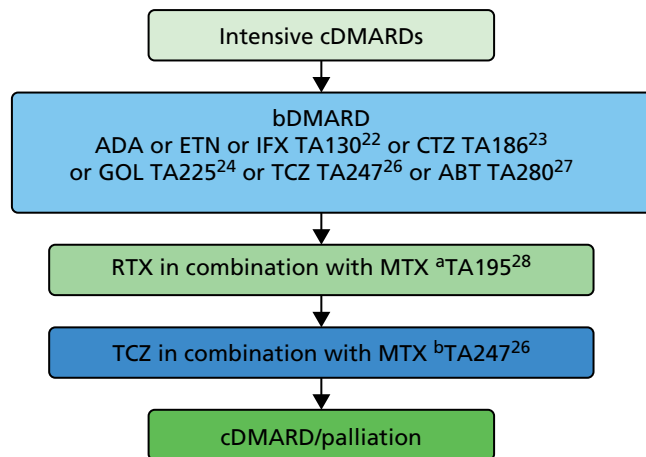
National Institute for Health and Care Excellence guidance (TA130,<sup>22</sup> TA186<sup>23</sup> and TA225<sup>24</sup>) recommends the use of the tumour necrosis factor (TNF) inhibitors etanercept (ETN; Enbrel®, Pfizer), infliximab [IFX; Remicade®, Merck Sharp & Dohme Corp. (MSD)], adalimumab (ADA; Humira®, AbbVie), certolizumab pegol (CTZ; Cimzia®, UCB Pharma) and golimumab (GOL; Simponi®, MSD) in people with RA after the failure of two cDMARDs, including MTX, and who have a DAS28  $> 5.1$ . Terminated NICE guidance (TA224) was unable to issue recommendations for the use of GOL in people with RA that have not been treated with MTX.<sup>25</sup>

Technology Appraisal 247<sup>26</sup> recommends tocilizumab (TCZ; RoActemra®, Roche) as an alternative to TNF inhibitors in the same circumstances as in TA130,<sup>22</sup> that is in patients with a DAS28  $> 5.1$  after trying two cDMARDs. NICE guidance TA280<sup>27</sup> recommends the use of intravenous (i.v.) abatacept (ABT; Orencia®, Bristol-Myers Squibb) in people with RA after the failure of cDMARDs in the same circumstances as TA130; the subcutaneous (s.c.) formulation has not been appraised.

A simplified summary of NICE-recommended bDMARDs is shown in *Figure 1*. This defines the sequence of treatments that have received positive guidance for patients with a DAS28 of  $> 5.1$ . In summary, the typical route would be intensive cDMARDs followed by a bDMARD, followed by rituximab (RTX) plus MTX, then TCZ before returning to cDMARDs.

It is noted that NICE CG79 recommends the use of intensive cDMARDs which have been assumed to be used rather than two cDMARDs used in monotherapy, although this latter option is acceptable.

The National Institute for Health and Care Excellence has also issued guidance (TA195,<sup>28</sup> TA225<sup>24</sup> and TA247<sup>26</sup>) on the treatment of RA after the failure of a TNF inhibitor, but such guidance falls outside the scope of this appraisal.



**FIGURE 1** Summary of the position of bDMARDs within NICE TA recommendations for sequence of treatments for patients with RA and a DAS28 > 5.1. a, If RTX and MTX is contraindicated or withdrawn owing to adverse events then the following can be used: ADA or ETN or IFX or ABT in combination with MTX; ADA or ETN monotherapy TA195,<sup>28</sup> TCZ in combination with MTX TA247,<sup>26</sup> assuming these have not been used previously in the sequence; b, would not be used if TCZ has been used previously in the sequence.

### National Institute for Health and Care Excellence criteria for continuing treatment

Each of the NICE TAs states that for patients to continue treatment with a bDMARD there must have been an improvement in DAS28 of at least 1.2 points at 6 months. If this criterion has not been met then treatment should be stopped and the next intervention in the sequence initiated.

Data were provided by the British Society for Rheumatology Biologics Register (BSRBR) to the Assessment Group and were used to assess the time on first biologic conditional on EULAR response. These indicate that over 25% of patients who had no EULAR response at 6 months were still on treatment at 4.5 years, with the median treatment time being 319 days. This shows that there is not strict adherence to the NICE criteria for continuation of treatment. The majority of patients (94%) had a DAS28 of > 5.1, indicating that the severity criteria stated by NICE were reasonably well adhered to.

## Description of the technologies under assessment

### Interventions considered in the scope of this report

The scope of the work is to ascertain the clinical effectiveness and cost-effectiveness of seven interventions within three populations that will be detailed subsequently. These interventions are ABT, ADA, CTZ, ETN, GOL, IFX and TCZ. It is noted that ABT can be delivered in two formulations, intravenously and subcutaneously, and that both have been modelled separately. Owing to the large number of interventions these have been initially summarised by mode of action. There then follows a summary of the UK marketing authorisation for each intervention along with a description of administration method. This text is similar to that within the protocol.<sup>29</sup>

### Mode of action

Adalimumab, ETN, IFX, CTZ and GOL all inhibit the activity of tumour necrosis factor alpha (TNF- $\alpha$ ), a pro-inflammatory mediator that is partly responsible for damage to the joints in RA.

Abatacept is a selective modulator of the T-lymphocyte activation pathway. It binds to molecules on the surface of antigen-presenting cells, preventing full activation of the T lymphocytes and interrupting the inflammatory process.

Tocilizumab inhibits the activity of the cytokine interleukin 6, a pro-inflammatory molecule that is also partly responsible for damage to the joints in RA.



### **Marketing licence and administration method**

Abatacept, in combination with MTX, has a UK marketing authorisation for the treatment of moderate to severe active RA in adult patients who responded inadequately to previous therapy with one or more cDMARDs, including MTX or a TNF- $\alpha$  inhibitor. It can be administered by i.v. infusion or by s.c. injection.

Adalimumab, in combination with MTX, has a UK marketing authorisation for the treatment of moderate to severe active RA in adults when the response to cDMARDs, including MTX, has been inadequate and for the treatment of severe, active and progressive RA in adults not previously treated with MTX. ADA can be given as monotherapy in case of intolerance to MTX or when continued treatment with MTX is inappropriate. It is administered subcutaneously.

Certolizumab pegol, in combination with MTX, has a UK marketing authorisation for the treatment of moderate to severe active RA in adult patients when the response to cDMARDs, including MTX, has been inadequate. CTZ can be given as monotherapy in case of intolerance to MTX or when continued treatment with MTX is inappropriate. It is administered subcutaneously.

Etanercept, in combination with MTX, has a UK marketing authorisation for the treatment of moderate to severe active RA in adults when the response to cDMARDs, including MTX (unless contraindicated), has been inadequate, and for the treatment of severe, active and progressive RA in adults not previously treated with MTX. ETN can be given as monotherapy in case of intolerance to MTX or when continued treatment with MTX is inappropriate. It is administered subcutaneously.

Golimumab, in combination with MTX, has a UK marketing authorisation for the treatment of moderate to severe active RA in adult patients when the response to cDMARD therapy, including MTX, has been inadequate, and for the treatment of severe, active and progressive RA in adults not previously treated with MTX. It is administered subcutaneously.

Infliximab, in combination with MTX, has a UK marketing authorisation for the reduction of signs and symptoms as well as the improvement in physical function in adults with active disease when the response to DMARDs, including MTX, has been inadequate. It is also licensed for the treatment of severe, active and progressive RA in adults not previously treated with MTX or other cDMARDs. It is administered by i.v. infusion.

Tocilizumab, in combination with MTX, has a UK marketing authorisation for the treatment of moderate to severe active RA in adult patients who have either responded inadequately, or who were intolerant, to previous therapy with one or more DMARDs or TNF antagonists. In these patients, TCZ can be given as monotherapy in case of intolerance to MTX or where continued treatment with MTX is inappropriate. TCZ is administered by i.v. infusion.

### **Current usage in the NHS**

There is widespread use of the interventions within the NHS. Robust values of the exact breakdown by intervention are not known.

### **Identification of important subgroups**

The current NICE guidance has already identified a subgroup by stating that to receive a bDMARD the patient must have received two cDMARDs and have active RA with a DAS28 in excess of 5.1. The research questions within this report include estimating the cost-effectiveness if the severity criteria were lessened to include patients with a DAS28 of > 3.2; and estimating the cost-effectiveness of using bDMARDs in advance of cDMARDs.

An important clinical subgroup encompasses those patients in whom bDMARDs cannot be given in combination with MTX. The clinical effectiveness and cost-effectiveness of licensed bDMARDs in this population will be estimated in this assessment.

### *The anticipated costs associated with the interventions*

The costs associated with each intervention need to take into account factors, including the acquisition cost of the drug [incorporating any Patient Access Scheme (PAS)]; the average weight of patients with RA for those interventions that are weight based; the administration costs associated with infusions and of district nurses performing s.c. injections; and any loading doses required in the first year.

The acquisition costs and dosing regimens were taken from the *British National Formulary* ([www.bnf.org](http://www.bnf.org); accessed June 2013<sup>30</sup>) with details of PASs taken from the manufacturers' submissions.

The average weights of patients with RA were estimated using data ( $n = 12,176$ ) from the BSRBR. To be able to be used with all of the weight-based dosing regimens, a large number of categories were required, as detailed in *Table 2*. From these categories the average cost per dose for those with a weight-based dose can be calculated.

Additional loading doses in the first year were calculated based on the relevant regimen and the administration cost. *Table 3* provides a simplified summary of the assumed mean acquisition costs per intervention and can be used to provide indicative rather than exact values. Within the mathematical model described later, timings of costs are explicitly incorporated and also the fact that in some subgroups the distribution of weights may differ from that of the full BSRBR database, a factor also considered within the Assessment Group model.

### *Additional treatments in a sequenced strategy*

The nature of RA treatment being sequenced meant that it was necessary for the Assessment Group and the manufacturers to incorporate the costs and effectiveness of RTX into the model as this has positive NICE guidance following the withdrawal of a bDMARD. These will be discussed as applicable.

**TABLE 2** The weight distribution of patients with RA using BSRBR data

Weight category (kg)	Number of patients	Percentage of total patients
0–30	3	0.0
31–33	7	0.1
34–35	9	0.1
36–45	240	2.0
46–50	484	4.0
51–60	2333	19.2
61–67	2115	17.4
68–70	949	7.8
71–75	1310	10.8
76–85	2148	17.6
86–95	1351	11.1
96–100	412	3.4
101–133	734	6.0
134–167	67	0.6
168–200	14	0.1
Total	12,176	100

TABLE 3 Simplified mean acquisition and administration costs for each intervention

Treatment	Dose regimen	Details of PAS if applicable	Cost per cheapest available dose, £ (dose)	Cost per weight-adjusted dose <sup>a</sup> /standard regimen, £	Administration costs per treatment, £	Cost per year (excluding administration costs <sup>b</sup> ), £	Additional costs in year 1, £
ABT (i.v.)	500 mg below 60 kg, 750 mg between 60 kg and 100 kg, 1000 mg above 100 kg; 0, 2 and 4 weeks then every 4 weeks thereafter	CiC information has been removed	CiC information has been removed (250 mg)	CiC information has been removed	154	CiC information has been removed	CiC information has been removed
ABT (s.c.)	125 mg weekly following loading dose 500 mg below 60 kg, 750 mg between 60 kg and 100 kg, 1000 mg above 100 kg	CiC information has been removed	CiC information has been removed (125 mg)	CiC information has been removed	3.05	CiC information has been removed	CiC information has been removed
ADA	40 mg; every other week	N/A	352.14 (40 mg)	352.14	3.05	9234.94	0
CTZ	400 mg per week initially, repeated at weeks 2 and 4 followed by a maintenance dose of 200 mg every 2 weeks	Initial 10 doses free	357.50 (200 mg)	357.50	3.05	9374.30	-2523.85 <sup>c</sup>
ETN	50 mg; every week	N/A	178.75 (50 mg)	178.75	3.05	9453.60	0
GOL	50 mg below 100 kg, 100 mg above 100 kg; per month	100 mg dose provided at the same price as the 50 mg dose	762.97 (50 mg)	762.97 <sup>d</sup>	3.05	9192.24	0
IFX <sup>e</sup>	3 mg/kg; 0, 2, 6 then every 8 weeks	N/A	419.62 (100 mg)	1110.98	154	8222.37 <sup>f</sup>	1820.47
TCZ	8 mg/kg every 4 weeks	CiC information has been removed	CiC information has been removed (80 mg)	CiC information has been removed	154	CiC information has been removed	0

CiC, commercial-in-confidence; N/A, not applicable.

a Assuming the weight distribution of patients from the BSRBR and choosing the least expensive method of meeting the requirement. The correct dose for a specific patient is calculated within the model.

b Assuming no vial sharing.

c This value has been simplified for clarity and is negative due to assuming 10 free doses in year 1 as detailed in the PAS. The model calculates the timing and number of doses correctly. Assuming that the cost of 100-mg syringes are set to the price of 50-mg syringes as per the previously agreed PAS.

d These values have been simplified for clarity, assuming 8 doses in year 1 and 6.5 in each subsequent year. The model calculates the timing and number of doses correctly.

f Assuming no increase in dose requiring additional vials, if the response is inadequate after 12 weeks, the dose may be increased in steps of 1.5 mg/kg every 8 weeks, up to a maximum of 7.5 mg/kg every 8 weeks; alternatively, 3 mg/kg may be given every 4 weeks.



## Chapter 2 Definition of the decision problem

### Decision problem

The aim of this assessment was to investigate the clinical effectiveness and cost-effectiveness of ADA, ETN, IFX, CTZ, GOL, TCZ and ABT for the treatment of RA not previously treated with bDMARDs compared with each other and compared with cDMARDs.

### Interventions

A detailed description of each of the interventions is provided in *Chapter 1, Description of the technologies under assessment*. *Table 4* summarises the relationship between the market authorisation and the decision problem detailed in *Overall aims and objectives of assessment*: that is, whether or not the intervention is licensed to be used prior to the initiation of MTX intervention; as a monotherapy (i.e. without needing to be given in combination with MTX); for patients with severe RA; and for patients with moderate to severe RA.

### Populations (including subgroups)

The scope issued by NICE defines three distinct populations with RA and includes (1) adults with severe active RA not previously treated with cDMARDs; (2) adults with severe active RA who have been previously treated with cDMARDs but not bDMARDs; and (3) adults with moderate to severe active RA who have been previously treated with cDMARDs only, including MTX (unless contraindicated or inappropriate). Henceforth, these will be referred to as population 1, population 2 and population 3, respectively.

Although the NICE scope did not specify the definition of severe active RA and moderate to severe active RA, the following definition (based on expert clinical advice to the Assessment Group) has been adopted: severe active RA will be defined by a DAS28 of  $\geq 5.1$  and moderate to severe active RA will be defined as a DAS28 of between 3.2 and 5.1.

As the scope issued by NICE explicitly defined subgroups, no further subgroups will be assessed, with the exception of those patients in whom bDMARD treatment needs to be given as monotherapy. Separate analyses will be conducted for those in whom MTX can be tolerated and in those who can only receive bDMARD monotherapy.

**TABLE 4** The relationship between the licence of the intervention and the decision problem

Intervention	Is the intervention licensed:			
	prior to the use of MTX?	as a monotherapy?	for patients with severe RA?	for patients with moderate to severe RA?
ABT <sup>a</sup>			✓	✓
ADA	✓	✓	✓	✓
CTZ		✓	✓	✓
ETN	✓	✓	✓	✓
GOL	✓		✓	✓
IFX	✓		✓	✓
TCZ		✓	✓	✓

a i.v. and s.c. formulations of ABT have been combined as the market authorisations are identical.

The Assessment Group has chosen to deviate from the scope for population 1 as the definition in the scope stated that MTX needed to have been used previously. Given this definition, the populations were mutually exclusive but not exhaustive, as patients without prior bDMARD treatment who had not received MTX but had instead received an alternative cDMARD would not be allocated to any of the populations. In consultation with NICE and our clinical experts the Assessment Group broadened its interpretation of population 1 to allow previous treatment with any cDMARD.

It is noted that the number of interventions considered in population 1 is fewer than for populations 2 or 3, as only four interventions (ADA, ETN, GOL and IFX) are licensed in this population.

### **Populations outside the scope of the research**

The following groups were explicitly excluded from the research by the scope issued by NICE:

- the initiation of treatment in patients without active RA
- patients with a DAS of < 3.2 who had received previous treatment with cDMARDs
- patients with a DAS of < 5.1 who had not been previously treated with cDMARDs
- patients who had been previously treated with one or more bDMARDs.

### **Relevant comparators**

The relevant comparators within the final scope differ according to the population considered. The scope stated that tofacitinib (TOF; Xeljanz®, Pfizer; Jakvinus®, Pfizer) would be included if NICE had issued positive guidance prior to the report's completion, but this did not occur and therefore TOF was not evaluated.

1. For severe active RA not previously treated with MTX or other DMARDs:
  - i. combination therapy with cDMARDs (including MTX and at least one other DMARD, such as SSZ and LEF as recommended in NICE CG79<sup>9</sup>)
  - ii. the interventions will be compared with each other.
2. For severe active RA that has been previously treated with cDMARDs only:
  - i. management strategies involving further cDMARDs (e.g. SSZ, LEF), NSAIDs and corticosteroids
  - ii. the interventions will be compared with each other.
3. For moderate to severe active arthritis that has been previously treated with cDMARDs only:
  - i. management strategies involving further cDMARDs (e.g. SSZ, LEF), NSAIDs and corticosteroids
  - ii. the interventions will be compared with each other.

### **Outcomes**

The outcome measures to be considered include:

- disease activity
- physical function
- joint damage
- pain
- mortality
- fatigue
- radiological progression
- extra-articular manifestations of disease
- adverse effects of treatment
- health-related quality of life.

Data were also collected on other outcome measures, including disease duration, number of previous cDMARDs and percentage of patients who had received bDMARDs, in case there was sufficient variation in baseline measurements that these could be investigated as treatment effect modifiers within data synthesis.

## Overall aims and objectives of assessment

The review aims to:

- evaluate the clinical effectiveness of each intervention in affecting key outcomes in patients within each of the defined subgroups
- evaluate the adverse effect profile of each intervention (and comparator)
- estimate the incremental cost-effectiveness within each of the defined subgroups of each intervention compared with all comparators
- estimate the overall cost of amending the current provision of interventions in the light of the cost-effectiveness results
- identify key areas for primary research.





## Chapter 3 Assessment of clinical effectiveness

A systematic review of the literature and network meta-analyses (NMAs) were conducted in order to evaluate the clinical effectiveness of ABT, ADA, CTZ, ETN, GOL, IFX and TCZ in the first-line bDMARD treatment of adults with RA.

The systematic review of the evidence was undertaken in accordance with the general principles recommended in the Preferred Reporting Items for Systematic Reviews and Meta-Analyses (PRISMA) statement ([www.prisma-statement.org/](http://www.prisma-statement.org/)).

This report contains reference to confidential information provided as part of the NICE appraisal process. This information has been removed from the report and the results, discussions and conclusions of the report do not include the confidential information. These sections are clearly marked in the report.

### Methods for reviewing effectiveness

#### Identification of studies

The aims of the search were to provide as comprehensive a retrieval as possible of clinical effectiveness evidence relating to ABT, ADA, CTZ, ETN, GOL, IFX and TCZ and to identify additional relevant treatments for potential inclusion in the NMA.

#### Electronic databases

Studies were identified by searching the following electronic databases and research registers:

- MEDLINE(R) In-Process & Other Non-Indexed Citations and MEDLINE(R) (via Ovid) 1948 to July 2013
- EMBASE (via Ovid) 1980 to July 2013
- Cochrane Database of Systematic Reviews (via Wiley Online Library) 1996 to May 2013
- Cochrane Central Register of Controlled Trials (via Wiley Online Library) 1898 to May 2013
- Health Technology Assessment (HTA) database (via Wiley Online Library) 1995 to May 2013
- Database of Abstracts of Review of Effects (via Wiley Online Library) 1995 to May 2013
- Cumulative Index to Nursing and Allied Health Literature (CINAHL) (via EBSCOhost) 1982 to April 2013
- Toxicology Literature Online to July 2013.

Given the broad scope of interventions to be included in the review and the high volume of potentially relevant studies to be sifted, the keyword searches of electronic resources were undertaken in three stages. No language or date restrictions were applied to any database. Details of keywords strategies are reported in *Appendix 1*.

Stage 1 was undertaken using keywords relating to the population only (i.e. RA) and did not include keywords relating to the interventions specified in the decision problem. The purpose was to keep the scope of the search broad in order to identify potentially relevant evidence for inclusion in the NMA, in addition to identifying RCTs and systematic reviews of the interventions of interest. For the searches of MEDLINE, EMBASE and CINAHL, methodological filters were added to restrict search results to RCTs and systematic reviews. To maximise the efficiency of the search process at this stage, filters aimed at maximising the precision of search results were applied.<sup>31–35</sup>

Stage 2 was undertaken using keywords relating to the population (RA) combined with keywords relating to the interventions of interest (ABT, ADA, CTZ, ETN, GOL, IFX and TCZ) and any interventions identified as potentially allowing indirect comparisons to be made within the NMA. Keyword synonyms relating to the interventions included generic drug names, product names and drug registry numbers. The purpose of stage 2 was to identify RCTs that might not have been retrieved by the 'high precision' stage 1 searches.

Therefore, RCT search filters aimed at maximising the sensitivity of search results were applied.<sup>33,36</sup> In the first instance, MEDLINE and EMBASE were searched. Given the high volume of references retrieved and the low yield in terms of relevant references identified, it was decided that searches would not be extended to other databases or to other treatments to be potentially included in the NMA.

Stage 3 involved the undertaking of searches for potential supplementary adverse events (AEs) evidence through the combination of keywords relating to the population (RA) with keywords relating to the interventions of interest (ABT, ADA, atacept, CTZ, ETN, GOL, IFX, RTX, TCZ, TOF). For the searches of MEDLINE and EMBASE, AE filters were applied,<sup>37</sup> whereas no filter was required for the Toxicology Literature Online database.

Where possible, and to minimise duplication between search results, the results retrieved by earlier search strategies were excluded from the results retrieved by later search strategies using the 'not' Boolean operator. The results retrieved by the MEDLINE and EMBASE high-precision searches (stage 1) were excluded from MEDLINE and EMBASE high-sensitivity searches (stage 2). The results retrieved by the MEDLINE and EMBASE high-precision and high-sensitivity searches (stages 1 and 2) were excluded from the AE searches (stage 3).

### Other resources

To identify additional studies, the reference lists of relevant studies (including existing systematic reviews) were checked and a citation search of relevant articles (using the Web of Science Citation Index Expanded and Conference Proceedings Citation Index – Science) was undertaken to identify articles that cite the relevant articles. It was originally intended in the protocol<sup>29</sup> that searches be performed to identify ongoing research and unpublished studies using the *metaRegister* of Current Controlled Trials, the World Health Organization International Clinical Trials Registry Platform, the European Union Clinical Trials Register, the Food and Drug Administration (FDA) and European Medicines Agency websites and the Web of Science Conference Proceedings Citation Index – Science. However, this was not possible within the time scales dictated by the NICE appraisal process. Hand-searching of relevant documents included sponsor submissions to the NICE TA update process, recent systematic reviews and documentation associated with previous relevant NICE TA guidance (TAs 130,<sup>22</sup> 186,<sup>23</sup> 224,<sup>25</sup> 234,<sup>38</sup> 225,<sup>24</sup> 247<sup>26</sup>). Grey literature was also sought using the sources listed in the international grey literature search toolkit produced by the Canadian Agency for Drugs and Technologies in Health.<sup>39</sup>

All identified citations from the electronic searches and other resources were imported into and managed using the Reference Manager bibliographic software (version 12.0; Thomson Reuters, Philadelphia, PA, USA).

### Inclusion and exclusion criteria

Inclusion and exclusion criteria for the selection of clinical effectiveness and safety evidence were defined according to the decision problem outlined in the NICE scope.<sup>40</sup>

The inclusion of potentially relevant articles was undertaken using a two-step process. First, all titles and abstracts were examined for inclusion by one reviewer. Any citations that clearly did not meet the inclusion criteria (e.g. animal studies, studies unrelated to RA) were excluded. Second, full-text articles were initially examined by one reviewer. It was intended in the original protocol that a second reviewer would check approximately 10% of citations. However, because of the very large number of citations identified in the clinical effectiveness searches, this was not possible in the time scales available for this appraisal process. Any uncertainty in the inclusion and exclusion of potential full-text articles was resolved through discussion with the review team. Where agreement could not be reached, expert clinical advice was sought for a final decision.

The relevance of each article for the systematic review was assessed according to the following criteria.

### Population

As detailed in *Chapter 2*, the three populations under consideration in this assessment were:

- i. Adults with severe active RA not previously treated with MTX (defined by a DAS of  $\geq 5.1$ ). In the original protocol<sup>29</sup> this population was defined as 'adults with severe active RA not previously treated with MTX or other DMARDs (defined by a DAS of  $\geq 5.1$ )'. However, this definition was subsequently modified and broadened by the Assessment Group (in consultation with clinical experts) to include 'adults with severe active RA not previously treated with MTX' to permit the inclusion of trial populations relevant to the decision problem which were MTX naive, but may have had some prior experience of other cDMARDs.
- ii. Adults with severe active RA who had been previously treated with conventional DMARDs only, including MTX (unless contraindicated or inappropriate) (defined by a DAS of  $\geq 5.1$ ).
- iii. Adults with moderate to severe active RA who had been previously treated with conventional DMARDs only, including MTX (unless contraindicated or inappropriate) (defined as a DAS between 3.2 and 5.1).

The following populations were considered outside the appraisal scope and were therefore excluded:

- patients with a DAS of  $< 3.2$
- patients with a DAS of  $< 5.2$  who had not been previously treated with MTX
- patients who had been previously treated with one or more biologic DMARDs.

### Interventions

The following interventions were included:

1. For RA not previously treated with MTX:
  - i. ADA
  - ii. ETN
  - iii. IFX
  - iv. GOL.
2. For RA that has been previously treated with conventional DMARDs only:
  - i. ADA
  - ii. ETN
  - iii. IFX
  - iv. CTZ
  - v. GOL
  - vi. ABT (i.v. and s.c. preparations)
  - vii. TCZ.

The above interventions were assessed in accordance with licensed indications and could be delivered in conjunction with cDMARDs or as monotherapy (as defined in licensed indications).

## Comparators

The relevant comparators differed according to the population considered and included the following:

1. For severe active RA not previously treated with MTX:
  - i. combination therapy with conventional DMARDs (including MTX and at least one other DMARD, such as SSZ and LEF) or DMARD monotherapy with dose escalation
  - ii. biologic interventions compared with each other.
2. For severe active RA that has been previously treated with conventional DMARDs only:
  - i. management strategies involving further conventional DMARDs (e.g. SSZ, LEF), NSAIDs and corticosteroids
  - ii. biologic interventions compared with each other.
3. For moderate to severe active RA that has been previously treated with conventional DMARDs only:
  - i. management strategies involving further conventional DMARDs (e.g. SSZ, LEF), NSAIDs and corticosteroids
  - ii. biologic interventions compared with each other.

## Outcomes

The outcome measures under consideration included:

- disease activity (DAS28, ACR and EULAR responses, swollen and tender joint counts and patient and physician global assessments of disease activity)
- physical function [Health Assessment Questionnaire Disability Index (HAQ-DI), but not modified versions of HAQ]
- joint damage/radiological progression
- pain
- mortality
- fatigue
- extra-articular manifestations of disease
- health-related quality of life
- adverse effects of treatment.

## Study design

The systematic review of clinical effectiveness was based on RCT evidence. It was stated in the protocol<sup>29</sup> that, if insufficient data were available from RCTs, observational studies or non-randomised trials may be considered (e.g. for safety evidence). The Assessment Group supplemented the AEs data identified in the included RCTs with safety data from long-term extension (LTE) studies reporting on individual included RCTs. Studies published as abstracts or conference presentations were only included if sufficient details were presented to allow both an appraisal of the methodology and an assessment of the results to be undertaken. Systematic reviews could be used as potential sources of additional references of efficacy evidence.

The following study types were also excluded:

- animal models
- preclinical and biological studies
- narrative reviews, editorials, opinions
- studies presenting secondary analyses of RCT data or pooled RCT data
- non-English-language papers.

### Data abstraction and critical appraisal strategy

Data relevant to the decision problem were extracted by one reviewer. Data were extracted without blinding to authors or journal. Study arms where intervention treatments were administered in line with licensed indications were extracted; where there was a slight divergence between the regimen used in the RCT and the licensed regimen, this was explicitly highlighted. It was proposed in the original protocol<sup>29</sup> that at least 10% of data extraction forms be checked by a reviewer. However, the Assessment Group ensured that all data included in the NMA were double checked by a second reviewer. For data not contributing to the NMA, data were extracted for the following time points: primary end point (for selected efficacy data); latest available controlled RCT end point (for efficacy and safety data); and latest available LTE study end point (for safety data only). The safety data extracted were informed by the Summary of Product Characteristics [available at [www.medicines.org.uk/emc/](http://www.medicines.org.uk/emc/) (accessed 1 April 2014)] and FDA prescribing information for each intervention.<sup>41–47</sup> Graphical data contributing to the NMA were estimated using Engauge software [version 4.1; Mark Mitchell, Los Angeles, CA, USA (2011)] and graphical data not contributing to the NMA were estimated manually by a reviewer. Where multiple publications of the same study were identified, data extraction was undertaken on all relevant associated publications and findings were presented as a single study. Discrepancies were resolved by discussion, with involvement of a third reviewer when necessary.

The methodological quality of each included study was assessed by one reviewer. It was originally intended in the protocol<sup>29</sup> that quality assessment would be checked by a second reviewer, but this was not feasible within the time scales available for the appraisal process. The quality assessment of included studies was informed by selected items listed in the NHS Centre for Reviews and Dissemination report<sup>48</sup> and Cochrane Risk of Bias tool.<sup>49</sup> Additional quality issues specific to the assessment of RA RCTs (as described by Karsh *et al.*<sup>50</sup>) were also considered during the evaluation of studies.

### Methods of data synthesis

The extracted data and quality assessment variables were presented for each study, both in structured tables and as a narrative description.

As the identified evidence base permitted the undertaking of NMAs for the estimation of treatment effects, supplementary meta-analyses were not undertaken. NMAs were conducted to determine efficacy using two different disease activity measures (ACR and EULAR responses).

### Methods for the estimation of efficacy using network meta-analysis

#### Selection of evidence contributing to the network meta-analysis

Evidence considered relevant to the decision problem was selected according to the additional inclusion criteria detailed below.

- Randomised controlled trials presenting ACR response or EULAR response data at any assessment time point between 22 and 30 weeks. The selection of this time frame and assumption that treatment effects would be broadly comparable across these assessment points was made in conjunction with the clinical advisors to the assessment. This criterion is broadly in line with previous data syntheses summarised by Thorlund *et al.*<sup>51</sup> 9 of the 13 RCTs in the NMA of biologic interventions for RA also employed an assessment time point in the region of 24 weeks/6 months; of the remaining four RCTs, three used 12-week data while one used data obtained between 50 and 55 weeks.
- Trials with early escape were included only if an appropriate imputation of data as determined by the Assessment Group was employed for dealing with censoring.
- Randomised controlled trials were not excluded from the base case on the basis of geographical location (a decision made in consultation with clinical advisors).
- Randomised controlled trials were permitted in the base case where it was not indicated if bDMARDs had been given (and no proportion of bDMARD use was provided), even if trial eligibility did not exclude prior bDMARDs.
- Trials reporting a small proportion of patients with prior bDMARD experience ( $\leq 20\%$ ) were not included in the base-case analyses but were explored via sensitivity analyses.

Sensitivity analyses were also undertaken to include trials relevant to populations 2 and 3 where the population may not have adequately failed cDMARDs (either there was a sufficient response, MTX treatment duration was too short or a proportion of the population were MTX naive).

Evidence was sought in which bDMARDs not considered as interventions or comparators within the NICE scope were evaluated in head-to-head trials with an included intervention in the first-line treatment of RA. To establish whether or not any such identified data could be used to inform indirect comparisons within the NMA, a review of these interventions against cDMARDs was undertaken. If such trials were found and met the inclusion criteria for the review, then the bDMARD was considered part of the evidence base for the NMA.

A number of assumptions relating to the evidence base were made in conjunction with clinical advisors: (1) It was assumed that all cDMARDs had the same efficacy; (2) it was also assumed that having failed a cDMARD was equivalent to having failed MTX; (3) trials that included the use of immunosuppressants or single intra-articular glucocorticoid were also permitted, assuming that this would not change the efficacy of cDMARDs; and (4) it was assumed that Disease Activity Score 28 C-reactive protein (DAS28-CRP) and Disease Activity Score 28 erythrocyte sedimentation rate (DAS28-ESR) are interchangeable where only one is reported. If both were reported, DAS28-ESR was used as this was reported most regularly (a decision made in consultation with clinical advisors). A systematic review to support assumptions (1) to (3) could not be undertaken within the time scales of the project. This may represent a limitation within the analyses although these assumptions were deemed reasonable by the clinical experts and there was no reason to believe these could cause a systematic bias.

### Statistical model for the network meta-analysis

European League Against Rheumatism and ACR outcomes are ordered categorical data. EULAR has three categories (no response, moderate response and good response) and ACR has four categories (no response, ACR20, ACR50 and ACR70). ACRXX represents an improvement of at least XX%; in the analysis, the categories are treated as mutually exclusive so that patients cannot be in more than one category.

The model for the data assumes that the treatment effect is the same irrespective of the category. The likelihood function for the data is described as follows:

- Let  $r_{ikj}$  represent the number of patients in arm  $k$  of trial  $i$  in the mutually exclusive category  $j = 1, 2, \dots, J$ .

The responses  $r_{ikj}$  will follow a multinomial distribution such that

$$r_{ikj=1, \dots, j} \sim \text{Multinomial}(p_{ikj=1, \dots, j}, n_{ik}), \sum_{j=1}^J p_{ikj=1, \dots, j} = 1. \quad (2)$$

The parameters in the model are the probabilities,  $p_{ikj}$ , that a patient in arm  $k$  of trial  $i$  has a response equivalent to category  $j$ .

We use a probit link function to map the probabilities,  $p_{ikj}$ , onto the real line such that:

$$\theta_{ikj} = \Phi^{-1}(p_{ikj}) = \mu_{ij} + \delta_{i,bk} I_{k \neq 1} \quad (3)$$

so that

$$p_{ikj} = \Phi(\mu_{ij} + \delta_{i,bk} I_{k \neq 1}). \quad (4)$$

In this model, the effect of treatment is to change the probit score of the control arm by  $\delta_{i,bk}$  standard deviations (SDs).

The study-specific treatment effects,  $\delta_{i,bk} |_{k \neq 1}$ , are assumed to arise from a common population distribution with mean treatment effect relative to the reference treatment, which in this analysis is cDMARDs, such that:

$$\delta_{i,1k} \sim N(d_{t_1, t_{ik}}, \tau^2). \quad (5)$$

We further assume that there is an underlying continuous latent variable which has been categorised by specifying cut-offs,  $z_{ij}$ , which correspond to the point at which an individual moves from one category to the next in trial  $i$ . The model is rewritten as:

$$p_{ikj} = \Phi(\mu_j + z_{ij} + \delta_{i,bk} |_{k \neq 1}). \quad (6)$$

The  $z_{ij}$  can be treated as fixed, which would assume that these points are the same in each trial and each treatment. Alternatively, they can be treated as random in which they are assumed to vary according to the trial but that within a trial they are the same such that:

$$z_{ic} \sim N(v_c, \sigma_z^2). \quad (7)$$

We used a model in which the  $z_{ij}$  were treated as being random because this resulted in a much better fit of the model to the data.

In some trials, the reported categories are a subset of the full set of categories so that there is overlap between categories. The multinomial likelihood is rewritten as a series of conditional binomial distributions such that for trial  $i$  reporting the number of patients,  $r_{ikj}$ , in category  $j = 1, \dots, J-1$ , we write:

$$r_{ikj} \sim \text{Binomial}(q_{ikj}, N_{ikj}), j = 1, \dots, j-1 \quad (8)$$

where

$$q_{ik1} = \text{Prob}(\text{Outcome in category 1 of trial } i) \quad (9)$$

$$q_{ik2} = \text{Prob}(\text{Outcome in category 2 of trial } i | \text{not in category 1}) \quad (10)$$

...

$$q_{ikj} = \text{Prob}(\text{Outcome in category } j \text{ of trial } i | \text{not in categories } 1, 2, \dots, j-1) \quad (11)$$

and

$$N_{ikj} = n_{ik} - \sum_{u=1}^{j-1} r_{iku}. \quad (12)$$

Further details of the model are presented in Dias *et al.*<sup>52</sup>

All analyses were conducted in the freely available software package WinBUGS (MRC Biostatistics Unit, Cambridge, UK).

The model is completed by giving the parameters prior distributions.

When there are sufficient sample data, we can use conventional reference prior distributions and these will have little influence on the posterior results. The reference prior distributions used in the analyses were:

- trial-specific baselines,  $\mu_i \sim N(0, 1000)$
- treatment effects relative to reference treatment,  $d_{1t} \sim N(0, 1000)$
- between-study SD of treatment effects,  $\tau \sim U(0, 2)$
- population cut-offs,  $v_{c_j} = v_{c_{j-1}} + v_{c_j}'$ ,  $v_{c_j}' \sim U(0, 5)$
- between-study SD of cut-offs,  $\sigma_z^2 \sim U(0, 2)$ .

In the case of the analysis of the EULAR data there were relatively few studies and too few to update the between-study SD. Without Bayesian updating, a reference prior distribution that does not represent genuine prior belief will have a significant impact on the results and give posterior distributions that are unlikely to represent genuine posterior beliefs. To allow for this, we used a weakly informative prior distribution for the between-study SD such that  $\tau \sim HN(0, 0.32^2)$ .

To estimate the absolute probabilities of being in each category for each treatment, we used a binomial likelihood function for the numbers of patients,  $r_{ik1}$  in each study that were classified as 'no response' when treated with cDMARDs such that:

$$r_{ik1} \sim \text{Binomial}(n_{ik}, p_{ik1}). \quad (13)$$

We used a probit link function such that:

$$\Phi^{-1}(p_{ik1}) = \mu_j'. \quad (14)$$

We assume that the study-specific baselines arise from population of effects such that:

$$\mu_j' \sim N(\mu_b, \tau_b^2). \quad (15)$$

The model was completed by giving the parameters prior distributions such that:

$$\begin{aligned} \mu_b &\sim N(0, 1000) \\ \tau_b &\sim U(0, 2). \end{aligned}$$

Again, there were relatively few studies providing data on the EULAR outcome so a weakly informative prior distribution was used for the between-study SD such that:  $\tau \sim HN(0, 0.32^2)$ .

For the baseline meta-analyses and NMAs, we used a standard burn-in of 100,000 iterations of the Markov chain and retained 25,000 iterations to estimate parameters. In addition, the NMAs exhibited moderately high correlation between successive iterations of the Markov chains so the chains were thinned by retaining every 10th sample.

For EULAR and ACR, analyses were performed according to whether the patient was MTX naive (population 1) or whether patients were MTX experienced (populations 2 and 3). Patients who were MTX naive were also analysed including the Treatment of Early Aggressive Rheumatoid arthritis (TEAR) trial<sup>53</sup> and the Trial of Etanercept and Methotrexate with Radiographic Patient Outcomes (TEMPO)<sup>54</sup> that included a small proportion of patients who were MTX experienced. In addition, for patients who were MTX experienced, EULAR was analysed according to the main trials and trials that included patients who received prior biologics [with and without the Actemra versus Methotrexate double Blind Investigative Trial In mONotherapy (AMBITION) study<sup>55</sup>] and ACR was analysed according to the main trials, trials that included patients who received prior biologics (with and without AMBITION<sup>55</sup>) and trials that included patients who were MTX naive.



We also explored the possibility that duration of disease was a treatment effect modifier. This was done for the main studies that provided ACR data. We did not attempt to adjust EULAR data for duration of disease because of the limited number of studies available. Duration of disease was centred in the model by subtracting the mean duration of disease across studies. Various models could be explored, including having an identical treatment effect modifier for each treatment, a separate treatment effect modifier for each treatment or allowing the treatment effect modifiers to be exchangeable across treatments. Again, because of the limited number of studies available we restricted attention to an exchangeable treatment effect modifier model. The model was completed by giving the common regression parameter a  $N(0, 1000)$  prior distribution and the between-treatment SD a  $U(0, 10)$  prior distribution. Results are not presented adjusted for duration of disease because the evidence suggested that it was not a treatment effect modifier (deviance information criterion adjusted = 1027.94, deviance information criterion unadjusted 1026.74).

## Results

### Quantity and quality of research available

#### Quantity of research available

As a result of the searches described in *Methods for reviewing effectiveness*, a total of 43,764 citations were identified for the review of clinical effectiveness and safety. This was reduced to 27,464 following deletion of duplicate citations. The study selection process is represented as a PRISMA diagram (Figure 2). A total of 27,334 citations were excluded at title and abstract levels (1606 being non-English-language records). Of the remaining records, a total of 60 studies were included in the review. Studies excluded at the full-text stage are presented (with rationale for exclusion) in *Appendix 3*.

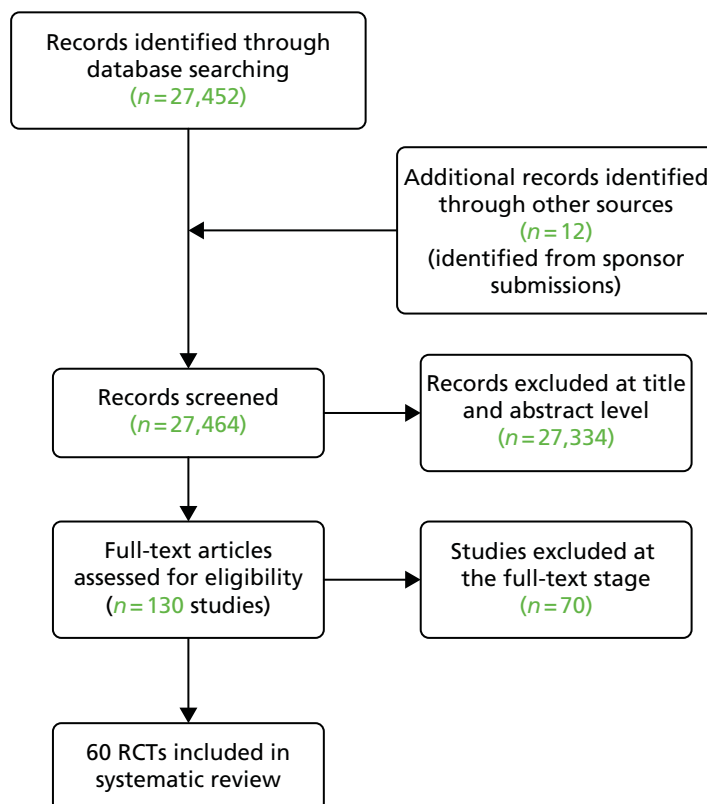


FIGURE 2 Flow diagram of study inclusion (adapted from PRISMA).

Randomised controlled trials included in the systematic review of clinical effectiveness and NMAs of ACR and EULAR responses are presented in *Table 5* (with MTX-naive and cDMARD-experienced labels denoting trials included in population 1 and populations 2 and 3 respectively).

Sixty RCTs were included in the systematic review of clinical effectiveness. These comprised six trials with head-to-head comparisons of included biologic interventions, [academic-in-confidence (AiC) information has been removed], and 53 trials of biologic interventions compared with placebo (PBO) or cDMARDs.

Methotrexate-naive trial populations are considered separately in the following results section as population 1. For population 1 there were a total of 15 RCTs included in the systematic review (ABT  $n = 0$ , ADA  $n = 6$ , CTZ  $n = 0$ , ETN  $n = 2$ , GOL  $n = 1$ , IFX  $n = 5$ , TCZ  $n = 0$  and head-to-head biologics  $n = 1$ ). Eight of the MTX-naive trials had data available for the NMA. All these seven trials provided ACR data; however, only one<sup>90</sup> contributed EULAR data for analysis. A head-to-head trial of ADA versus ETN was identified but this trial was not eligible for the NMA (due to early escape at 12 weeks with no imputation for missing data).<sup>100</sup>

There were 45 trials with cDMARD-experienced populations (considered as populations 2 and 3) (ABT  $n = 3$ , ADA  $n = 7$ , CTZ  $n = 2$ , ETN  $n = 11$ , GOL  $n = 3$ , IFX  $n = 7$ , TCZ  $n = 6$ , head-to-head biologics  $n = 5$  and grouped antiTNFs  $n = 1$ ). Of these, 30 trials had data available for the NMA.

**TABLE 5** Trials included in the systematic review and NMAs

Trial name/study	Intervention	Population	Included in NMA?
Abe <i>et al.</i> , 2006 <sup>56</sup>	IFX	cDMARD experienced	Not in NMA (14-week RCT)
ACT-RAY <sup>57</sup>	TCZ	cDMARD experienced	Yes
ADACTA <sup>58</sup>	ADA, TCZ	cDMARD experienced	Yes
ADORE <sup>59,60</sup>	ETN	cDMARD experienced	Not in NMA (16-week study)
AIM <sup>61-65</sup>	ABT	cDMARD experienced	Yes
AMPLE <sup>66</sup>	ADA, ABT	cDMARD experienced	Yes
APPEAL <sup>67,68</sup>	ETN	cDMARD experienced	Not in NMA (16-week study)
ARMADA <sup>69,70</sup>	ADA	cDMARD experienced	Yes
ASPIRE <sup>71</sup>	IFX	MTX naive	Not in NMA (no ACR/EULAR data at 22–30 weeks)
ASSET <sup>72</sup>	ABT	cDMARD experienced	Not in NMA (4-month RCT)
ASSURE <sup>73</sup>	ABT	cDMARD experienced	Not in NMA (no ACR/EULAR data at 22–30 weeks)
ATTEST <sup>74</sup>	IFX, ABT	cDMARD experienced	Yes
ATTRACT <sup>75</sup>	IFX	cDMARD experienced	Yes
AUGUST II <sup>76</sup>	ADA	cDMARD experienced	Yes
Bejarano <i>et al.</i> , 2008 <sup>77</sup>	ADA	MTX naive	Not in NMA (no ACR/EULAR data at 22–30 weeks)
BeST <sup>78</sup>	IFX	MTX naive	Yes
CERTAIN <sup>79</sup>	CTZ	cDMARD experienced	Yes
CHANGE <sup>80</sup>	ADA	cDMARD experienced	Yes
COMET <sup>81-83</sup>	ETN	MTX naive	Yes
DE019 <sup>84</sup>	ADA	cDMARD experienced	Yes

TABLE 5 Trials included in the systematic review and NMAs (continued)

Trial name/study	Intervention	Population	Included in NMA?
deFilippis <i>et al.</i> , 2006 <sup>85</sup>	ETN, IFX	cDMARD experienced	Yes
Durez <i>et al.</i> , 2004 <sup>86</sup>	IFX	cDMARD experienced	Not in NMA (14-week study, no valid comparator arm)
Durez <i>et al.</i> , 2007 <sup>120</sup>	IFX	MTX naive	Yes
ERA <sup>87</sup>	ETN	MTX naive	Yes
ETN Study 309 <sup>88,89</sup>	ETN	cDMARD experienced	Yes
GO-BEFORE <sup>90</sup>	GOL	MTX naive	Yes
GO-FORTH <sup>91</sup>	GOL	cDMARD experienced	Yes
GO-FORWARD <sup>92</sup>	GOL	cDMARD experienced	Yes
GUEPARD <sup>93</sup>	ADA	MTX naive	Not in NMA (no ACR/EULAR data at 22–30 weeks)
HIT HARD <sup>94</sup>	ADA	MTX naive	Yes
IDEA <sup>95</sup>	IFX	MTX naive	Not in NMA (no ACR/EULAR data at 22–30 weeks)
CREATE IIB <sup>96</sup>	ETN	cDMARD experienced	Yes
JESMR <sup>97</sup>	ETN	cDMARD experienced	Yes
Kay <i>et al.</i> , 2008 <sup>98</sup>	GOL	cDMARD experienced	Not in NMA [no eligible ACR/EULAR data at 22–30 weeks (owing to PBO group crossover)]
Kim <i>et al.</i> , 2007 <sup>99</sup>	ADA	cDMARD experienced	Yes
Kume <i>et al.</i> , 2011 <sup>100</sup>	ADA, ETN	MTX naive	Not in NMA (early escape at 12 weeks with no imputation for missing data)
Lan <i>et al.</i> , 2004 <sup>101</sup>	ETN	cDMARD experienced	Not in NMA (12-week study)
LARA <sup>102</sup>	ETN	cDMARD experienced	Yes
MEASURE <sup>103</sup>	TCZ	cDMARD experienced	Not in NMA (no ACR/EULAR data at 22–30 weeks)
Moreland <i>et al.</i> , 1999 <sup>104</sup> / Mathias <i>et al.</i> , 2000 <sup>105</sup>	ETN	cDMARD experienced	Yes
Nishimoto <i>et al.</i> , 2004 <sup>106</sup>	TCZ	cDMARD experienced	Not in NMA (no ACR/EULAR data at 22–30 weeks)
OPERA <sup>107</sup>	ADA	MTX naive	Not in NMA (no ACR/EULAR data at 22–30 weeks)
OPTIMA <sup>108</sup>	ADA	MTX naive	Yes
PREMIER <sup>109</sup>	ADA	MTX naive	Yes
Quinn <i>et al.</i> , 2005 <sup>110</sup>	IFX	MTX naive	Not in NMA (no ACR/EULAR data at 22–30 weeks)
RACAT <sup>111</sup> /O'Dell <i>et al.</i> , 2013 <sup>112</sup>	ETN	cDMARD experienced	Yes
REALISTIC <sup>113</sup>	CTZ	cDMARD experienced	Not in NMA (no biologic-naive ACR/EULAR data at 22–30 weeks)

continued

TABLE 5 Trials included in the systematic review and NMAs (continued)

Trial name/study	Intervention	Population	Included in NMA?
RED-SEA <sup>114</sup>	ADA, ETN	cDMARD experienced	Not in NMA (no ACR/EULAR data at 22–30 weeks)
SAMURAI <sup>115</sup>	TCZ	cDMARD experienced	Yes
SATORI <sup>116</sup>	TCZ	cDMARD experienced	Yes
STAR <sup>117</sup>	ADA	cDMARD experienced	Yes
START <sup>118</sup>	IFX	cDMARD experienced	Yes
Swefot <sup>119</sup>	IFX	cDMARD experienced	Yes
AiC information has been removed	AiC information has been removed	AiC information has been removed	AiC information has been removed
TOWARD <sup>121</sup>	TCZ	cDMARD experienced	Yes
Van De Putte <i>et al.</i> , 2004 <sup>122</sup>	ADA	cDMARD experienced	Yes
Wajdula 2000 (reported in Chen <i>et al.</i> , 2006 <sup>123</sup> )	ETN	cDMARD experienced	Not in NMA (12-week study)
Weinblatt <i>et al.</i> , 1999 <sup>124</sup>	ETN	cDMARD experienced	Yes
Wong <i>et al.</i> , 2009 <sup>125</sup>	IFX	cDMARD experienced	Not in NMA (no ACR/EULAR data at 22–30 weeks)
Zhang <i>et al.</i> , 2006 <sup>126</sup>	IFX	cDMARD experienced	Not in NMA (18-week study)

ACT-RAY, ACTemra (tocilizumab) RAdiographic studY; ADACTA, ADalimumab ACTemrA (tocilizumab) head-to-head-study; ADORE, ADjuvant Oxaliplatin in REctal Cancer; AiC, academic-in-confidence; AIM, Abatacept in Inadequate responders to Methotrexate; AMPLE, abatacept vs. adalimumab in biologic naive RA patients with background MTX; APPEAL, Asia-Pacific Study in Patients to be Treated With Etanercept or an Alternative Listed; ARMADA, Anti-TNF factor Research study program of the Monoclonal antibody ADalimumab (D2E7) in rheumatoid Arthritis; ASPIRE, Active controlled Study of Patients receiving Infliximab for the treatment of Rheumatoid arthritis of Early onset; ASSET, Abatacept Systemic Sclerosis Trial; ASSURE, Abatacept Study of Safety in Use with other RA Therapies; ATTEST, A Trial for Tolerability, Efficacy, and Safety in Treating rheumatoid arthritis (infliximab); ATTRACT, Anti-TNF trial in Rheumatoid Arthritis with Concomitant Therapy; AUGUST II, A Phase II Dose-finding Study of Atacept in Rheumatoid Arthritis (RA); BeST, BEhandelings STRategie; CERTAIN, efficacy and safety of CERTolizumab pegol After INcomplete response to DMARDS in RA patients with low to moderate disease activity; CHANGE, Clinical investigation in Highly disease-affected rheumatoid Arthritis patients in Japan with Adalimumab applying staNdard and General Evaluation study; COMET, Combination Of METHotrexate and etabercept in early rheumatoid arthritis; CREATE IIb, A 6-month Randomised, Double-blind, Open Arm Comparator, Phase IIb, With AZD9056, in Patients With Rheumatoid Arthritis (RA); DE019, Efficacy and Safety of Adalimumab in Patients With Active Rheumatoid Arthritis Treated Concomitantly With Methotrexate; ERA, Early Rheumatoid Arthritis (etanercept); GO-BEFORE, GOLimumab in active rheumatoid arthritis BEFORE methotrexate therapy; GO-FORTH, golimumab in combination with methotrexate in Japanese patients with active rheumatoid arthritis; GO-FORWARD, golimumab in active rheumatoid arthritis despite methotrexate therapy; GUEPARD, GUÉrir la PolyARthrite rhéumatoïde Débutante (adalimumab); HIT HARD, High Induction THERapy with Anti-Rheumatic Drugs (adalimumab and methotrexate); IDEA, Remission induction comparing infliximab and high-dose intravenous steroid, followed by treat-to-target: a double-blind, randomised, controlled trial in new-onset, treatment-naïve, rheumatoid arthritis; JESMR, Japanese Efficacy and Safety of Etanercept on Active Rheumatoid Arthritis Despite Methotrexate Therapy; LARA, Latin American Rheumatoid Arthritis study; MEASURE, secukinumab in ankylosing spondylitis; OPERA, OPTimized treatment algorithm for patients with Early Rheumatoid Arthritis; OPTIMA, OPTimal protocol for treatment Initiation with Methotrexate and Adalimumab; PBO, placebo; PREMIER, Patients REceiving Methotrexate and Infliximab for the treatment of Early Rheumatoid arthritis; RACAT, Rheumatoid Arthritis Comparison of Active Therapies in Methotrexate Suboptimal Responders study; REALISTIC, RA EvALuation In Subjects receiving TNF Inhibitor Certolizumab pegol; RED-SEA, a Randomised Efficacy and Discontinuation Study of Etanercept versus Adalimumab; SAMURAI, Study of Active controlled Monotherapy Used for Rheumatoid Arthritis, an IL-6 Inhibitor; SATORI, Study of Active controlled Tocilizumab for Rheumatoid arthritis patients with an Inadequate response to methotrexate; STAR, Safety Trial of Adalimumab in Rheumatoid arthritis; START, Safety Trial for rheumatoid Arthritis with Remicade Therapy; Swefot, Swedish pharmacotherapy; TOWARD, TOcilizumab in combination With traditional DMARD therapy.

Twelve trials that did not satisfy the inclusion criteria for the systematic review (as outlined in *Methods for reviewing effectiveness*) were excluded from the systematic review but were used as additional evidence and explored in sensitivity analyses in the NMA (Table 6). These trials contributed ACR and/or EULAR data to sensitivity analyses only. Of these, 10 trials had populations with a small proportion that had received prior biologics ( $\leq 20\%$ ). The other remaining trials were not in the base case because they had populations in which some patients were MTX naive or cDMARD and others were not, or patients were responding to MTX.

In addition, two trials providing supplementary network linkages were included in the NMA. These RCTs did not include any of the included interventions as specified in the decision problem, but evaluated TOF versus PBO.<sup>137,138</sup> Both of these trial populations had some prior biologic use (and therefore these trials were considered within the NMA sensitivity analyses).

### Quality of research available

The quality of the included RCTs is presented in Table 345 (see Appendix 4) and summarised in Figure 3. There is a reasonably low risk of bias overall among studies included in this review. Items where risk of bias was greatest were those that assessed comparability of groups, blinding and selective reporting. Items generating a large proportion of 'unclear' responses (indicating a lack of clarity in reporting) were those relating to generation of allocation sequence, allocation concealment and selective reporting of outcomes. Items with a low risk of bias in a large proportion of trials were comparability at baseline, blinding, analysis

**TABLE 6** Trials not eligible for the systematic review but providing additional evidence for NMA sensitivity analyses

Trial name/study	Intervention	Allocated population	Rationale for ineligibility in systematic review
ACQUIRE <sup>127</sup>	ABT	cDMARD experienced	3.4–6% prior biologics
AMBITION <sup>55,128</sup>	TCZ	cDMARD experienced	5–9% prior biologics, mix of MTX naive and prior MTX
Yamamoto <i>et al.</i> , 2011 <sup>129</sup>	CTZ	cDMARD experienced	16% prior biologics
LITHE <sup>130</sup>	TCZ	cDMARD experienced	11% prior biologics
NCT00254293 <sup>131</sup>	ABT	cDMARD experienced	2.6% prior biologics
OPTION <sup>132</sup>	TCZ	cDMARD experienced	5–9% prior biologics
ORAL Standard <sup>133</sup>	ADA, TOF	cDMARD experienced	10% prior biologics
RA0025 <sup>134</sup>	CTZ	cDMARD experienced	15% prior biologics
RAPID1 <sup>135</sup>	CTZ	cDMARD experienced	4% prior biologics
RAPID2 <sup>136</sup>	CTZ	cDMARD experienced	1.6% prior biologics
TEAR <sup>53</sup>	ETN	cDMARD experienced and MTX naive	Mix of MTX-naive and prior MTX, some patients (less than 30%) had any prior cDMARD use
TEMPO <sup>54</sup>	ETN	cDMARD experienced and MTX naive	Mix of MTX-naive, and prior MTX but not inadequate response
Kremer <i>et al.</i> , 2012 <sup>137</sup>	TOF	cDMARD experienced	Did not include any bDMARD within the NICE scope
van der Heijde <i>et al.</i> , 2013 <sup>138</sup>	TOF	cDMARD experienced	Did not include any bDMARD within the NICE scope

ACQUIRE, subcutaneous abatacept versus intravenous abatacept; LITHE, tocilizumab safety and the prevention of structural joint damage methotrexate and sulfasalazine combination trial; OPTION, tocilizumab Pivotal Trial In methotrexate inadequate responders; ORAL Standard, Tofacitinib or Adalimumab versus Placebo in Rheumatoid Arthritis; RAPID, Rheumatoid Arthritis Prevention of structural Damage.

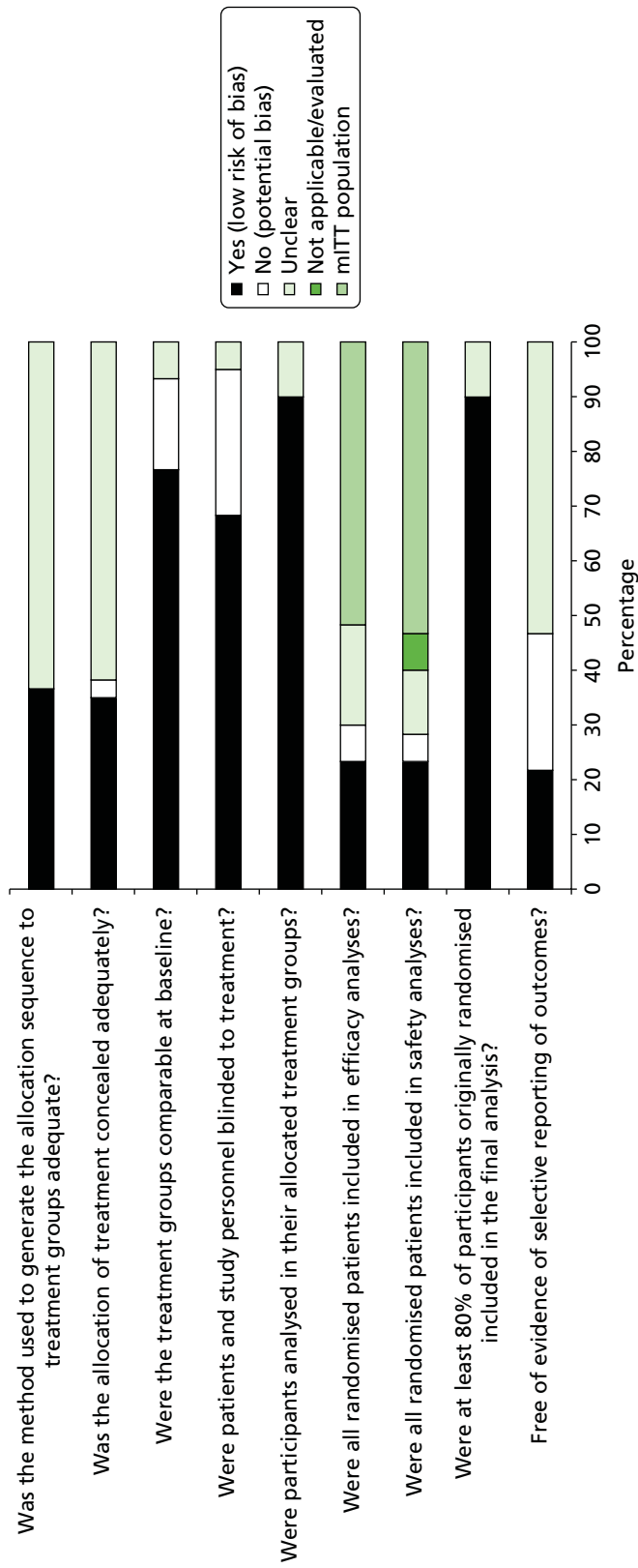


FIGURE 3 Risk-of-bias graph. mITT, modified intention to treat.

by allocated treatment group and most ( $\geq 80\%$ ) participants randomised included in the final analysis. A modified intention-to-treat population was used in around half of trials for efficacy and safety analyses (which was typically based on all randomised patients who received at least one dose of study drug being included in analyses).

### Summary of trials and population characteristics

There were some differences between trials in population characteristics, treatment and trial duration. For some trials, intervention and control arms differed in terms of numbers/combinations of concomitant cDMARDs. Some trials allowed physician discretion in other therapies. There was some variation between trials in prior treatment history and disease duration. There was some variation in how early withdrawals were decided, with variation in length of time on allocated treatment.

## Trial characteristics

### *Adults with severe active rheumatoid arthritis not previously treated with methotrexate (population 1)*

As discussed in *Methods for reviewing effectiveness*, trials in which populations were MTX naive but had received some prior treatment with other cDMARDs were considered appropriate for inclusion in population 1. Study characteristics for trials included in population 1 are presented in *Tables 345* and *346* (see *Appendix 4*).

### *Adults with moderate to severe and severe active rheumatoid arthritis that have been previously treated with cDMARDs (but not bDMARDs) (cDMARD experienced) (populations 2 and 3)*

Study characteristics for trials included in populations 2 and 3 are presented in *Tables 347–349* (see *Appendix 4*).

## Population characteristics

### *Adults with severe active rheumatoid arthritis not previously treated with methotrexate (population 1)*

Population characteristics for population 1 are presented in *Tables 7* and *8*.

**TABLE 7** Population characteristics: population 1 – biologic head-to-head RCTs

Study	Treatment arms	Mean age (years) (SD)	Sex (% female)	Early withdrawal plan reported?	Disease duration (years) (SD)	Mean DAS28 at baseline (SD) – ESR unless stated to be CRP
Kume <i>et al.</i> , 2011 <sup>100</sup>	ADA monotherapy (n = 22)	63 (17)	85.7	Yes	0.75 (0.42)	ESR 5.34 (1.4)
	ETN monotherapy (n = 21)	51 (15)	85.7		0.92 (0.42)	ESR 5.17 (1.5)

TABLE 8 Population characteristics: population 1 – RCTs of biologic vs. DMARD(s) or PBO

Trial name/ study	Treatment arms	Mean age (years) (SD)	Sex (% female)	Early withdrawal plan reported?	Disease duration (years) (SD)	Mean DAS28 at baseline (SD) – ESR unless stated to be CRP
Bejarano <i>et al.</i> , 2008 <sup>77</sup>	PBO + MTX (n = 73)	47 (9)	53.4	Yes	6.6	6.0 (1.5)
	ADA + MTX (n = 75)	47 (9)	58.4		7.9	5.9 (1.4)
GUEPARD <sup>93</sup>	Initial MTX 12 weeks, then step-up therapy <sup>a</sup> based on DAS28 (n = 32)	49.3 (15.2)	81.25	Yes	4.4 (3.3–5.1) <sup>b</sup> months	ESR 6.15 (0.88); CRP 5.85 (0.91)
	Initial ADA + MTX 12 weeks, then step-up <sup>a</sup> therapy based on DAS28 (n = 33)	46.3 (16.3)	78.79		4.4 (3.3–5.1) <sup>b</sup> months	ESR 6.31 (0.78); CRP 5.80 (0.83)
HIT HARD <sup>94</sup>	MTX + PBO (n = 85)	52.5 (14.3)	67.1	NR	0.13 (NR)	6.3 (0.9)
	ADA + PBO (n = 87)	47.2 (12.1)	70.1		0.15 (NR)	6.2 (0.8)
OPERA <sup>107</sup>	MTX + PBO + steroid (n = 91)	5.42 (28.3, 76.7) <sup>c</sup>	69	Yes	0.22 (0.12, 0.41) <sup>c</sup>	CRP 5.6 (3.8, 7.3) <sup>c</sup>
	ADA + MTX + steroid (n = 89)	56.2 (25.8, 77.6) <sup>c</sup>	63		0.24 (0.12, 0.44) <sup>c</sup>	CRP 5.5 (3.8, 7.8) <sup>c</sup>
OPTIMA <sup>108</sup>	MTX + PBO (n = 517)	50.7 (NR)	74	NR	0.38 (NR)	6
	ADA + MTX (n = 515)	50.4 (NR)	74		0.30 (NR)	6
PREMIER <sup>109</sup>	MTX + PBO (n = 257)	52.0 (13.1)	73.9	Yes	0.8 (0.9)	6.3 (0.9)
	ADA monotherapy + PBO step-up week 16 (n = 274)	52.1 (13.5)	77.4		0.7 (0.8)	6.4 (0.9)
COMET <sup>81,82</sup>	ADA + MTX step-up week 16 (n = 268)	51.9 (14.0)	72.0		0.7 (0.8)	6.3 (0.9)
	MTX + PBO (n = 268)	52.3 (0.8)	73	NR	Months 9.3 (0.4)	6.5 (1.0)
	ETN + MTX (n = 274)	50.5 (0.9)	74		Months 8.8 (0.4)	6.5 (1.0)



Trial name/ study	Treatment arms	Mean age (years) (SD)	Sex (% female)	Early withdrawal plan reported?	Disease duration (years) (SD)	Mean DAS28 at baseline (SD) – ESR unless stated to be CRP
Bathon and Genovese, 2000 <sup>39</sup>	MTX + PBO (n = 217)	49 (13)	75	NR	1 (0.92)	NR
	ETN + PBO (n = 207)	50 (13)	74		1 (0.92)	NR
GO-BEFORE <sup>90</sup>	PBO+MTX (n = 160)	48.6 (12.91)	83.8	NR	≤ 3 years = 72.5%; ≤ 2 years = 61.9%; ≤ 1 year = 45.6%	ESR 6.2 (1.17); CRP 5.6 (1.06)
	GOL + MTX (n = 159)	50.9 (11.32)	84.9		≤ 3 years = 73.0%; ≤ 2 years = 64.2%; ≤ 1 year = 50.9%	ESR 6.3 (1.11); CRP 5.7 (1.05)
ASPIRE <sup>71</sup>	PBO i.v. + MTX (n = 298)	50 (13)	75	NR	0.9 (0.7)	NR
	IFX + MTX (n = 373)	51 (12)	71		0.8 (0.7)	NR
BeST <sup>78</sup>	Sequential monotherapy (DAS steered) (n = 126)	54 (13)	68	Yes	23 weeks <sup>d</sup>	DAS44 4.5 (0.9)
	Step-up combination therapy (DAS steered) (n = 121)	54 (13)	71		26 weeks <sup>d</sup>	DAS44 4.5 (0.8)
	Initial combination therapy with prednisone (DAS steered) (n = 133)	55 (14)	65		23 weeks <sup>d</sup>	DAS44 4.4 (0.9)
	Initial combination therapy with IFX (DAS steered) (n = 128)	54 (14)	66		23 weeks <sup>d</sup>	DAS44 4.3 (0.9)
Durez <i>et al.</i> , 2007 <sup>120</sup>	MTX (n = 14)	53.8 (15.2)	71	NR	0.45 (0.29)	CRP 5.2 (0.8)
	MTX + MP (n = 15)	50.3 (14.2)	60		0.25 (0.33)	5.3 (1.3)
	IFX + MTX (n = 15)	50.0 (9.9)	67		0.36 (0.31)	5.3 (1.1)

continued

TABLE 8 Population characteristics: population 1 – RCTs of biologic vs. DMARD(s) or PBO (continued)

Trial name/ study	Treatment arms	Mean age (years) (SD)	Sex (% female)	Early withdrawal plan reported?	Disease duration (years) (SD)	Mean DAS28 at baseline (SD) – ESR unless stated to be CRP
IDEA <sup>95</sup>	MP + MTX (n = 112 across both groups)  IFX 3 mg/kg i.v. at weeks 0, 2, 6, 14, 22 + MTX (IFX dose modifications permitted according to DAS44 from week 26)	NR  NR	NR  NR	Yes	NR (described as early RA, 3–12 months symptom duration)  NR	NR  NR
Quinn <i>et al.</i> , 2005 <sup>110</sup>	MTX + PBO (n = 10)  IFX + MTX (n = 10)	53.1 (13.7)  51.3 (9.5)	70  60	NR	0.5 (0.31)  0.62 (0.38)	7.0 (0.9)  6.2 (0.8)

ASPIRE, Active controlled Study of Patients receiving Infliximab for the treatment of Rheumatoid arthritis of Early onset; BeST, BEhandlings Strategie; COMET, Combination Of Methotrexate and etabercept in early rheumatoid arthritis; DAS44, Disease Activity Score 44 joints; GO-BEFORE, Golimumab in active rheumatoid arthritis BEFORE methotrexate therapy; GUEPARD, GUÉrir la PolyARthrite rhéumatoïde Débutante (adalimumab); HIT HARD, High Induction Therapy with Anti-Rheumatic Drugs (adalimumab and methotrexate); IDEA, Remission induction comparing infliximab and high-dose intravenous steroid, followed by treat-to-target: a double-blind, randomised, controlled trial in new-onset, treatment-naïve, rheumatoid arthritis; MP, methylprednisolone; NR, not reported; OPERA, Optimized treatment algorithm for patients with Early Rheumatoid Arthritis; OPTIMA, OPTimal protocol for treatment initiation with Methotrexate and Adalimumab; PREMIER, Patients Receiving Methotrexate and Infliximab for the treatment of Early Rheumatoid arthritis.

a More details in *Appendix 4, Table 336*.  
b Median (interquartile range).  
c Median (5th, 95th centile range).  
d Median.

Data are shown to the level of accuracy available in the source material.

**Adults with moderate to severe and severe active rheumatoid arthritis who have been previously treated with cDMARDs (but not bDMARDs) (cDMARD experienced) (populations 2 and 3)**

Population characteristics for populations 2 and 3 are presented in *Tables 9 and 10*.

Additional population characteristics are outlined in *Tables 350–355* (see *Appendix 4*).

### Assessment of effectiveness

#### Disease activity and physical function

##### American College of Rheumatology response

**Population 1** One head-to-head RCT in MTX-naïve patients was identified in the systematic review.<sup>100</sup> However, no ACR response data were available in this trial. A total of 13 RCTs of biologic versus DMARD(s) or PBO reported ACR response data in MTX-naïve patients (six for ADA,<sup>77,93,94,107,109,142</sup> two for ETN,<sup>81,139</sup> one for GOL<sup>90</sup> and four for IFX<sup>71,78,110,120</sup>) (*Table 11*). Statistically significant differences in ACR response favouring biologic treatment over comparator were reported for ADA (four studies<sup>94,107,109,142</sup>), ETN (two studies<sup>81,139</sup>), GOL (one study<sup>90</sup>) and IFX (two studies<sup>71,120</sup>). Seven of the 12 RCTs contributed data to a NMA of ACR response for population 1 (three for ADA,<sup>94,109,142</sup> one for ETN,<sup>81,139</sup> one for GOL<sup>90</sup> and two for IFX<sup>78,120</sup>).

(NB: in the outcome tables that follow throughout *Results*, citations are provided where data were extracted from sources additional to the primary publication.)

**Populations 2 and 3** Four head-to-head RCTs reporting ACR response data in cDMARD-experienced patients were identified (*Table 12*). Statistically significantly greater proportions of patients achieved ACR20, ACR50 and ACR70 responses in the IFX plus MTX and abatacept i.v. plus MTX treatment groups of the A Trial for Tolerability, Efficacy, and Safety in Treating rheumatoid arthritis (infliximab) (ATTEST) trial,<sup>74</sup> when compared against PBO plus MTX. Statistically significant findings were also identified in the Adalimumab ACTemra (tocilizumab) head-to-head study (ADACTA), whereby greater proportions of patients receiving TCZ monotherapy achieved ACR responses than among patients receiving ADA monotherapy.<sup>58</sup> Thirty-six RCTs evaluating biologic versus DMARD(s) or PBO in cDMARD-experienced patients reported ACR response data (*Table 13*). Statistically significant findings were reported (four ADA trials,<sup>76,84,117,122</sup> one CTZ trial,<sup>79</sup> eight ETN trials,<sup>89,101,102,104,105,111,124,140</sup> three GOL trials,<sup>91,92,98</sup> five IFX trials<sup>75,86,118,119,126</sup> and three TCZ trials<sup>106,115,121</sup>) for ACR response across a range of time points favouring biologic over comparator treatment.

##### European League Against Rheumatism response

**Population 1** The only head-to-head trial for MTX-naïve patients<sup>100</sup> did not report EULAR data. Three MTX-naïve trials reported EULAR data, of which two were ADA trials<sup>93,107</sup> and one was a GOL trial<sup>90</sup> (*Table 14*). GUÉrir la PolyArthrite rhumatoïde Débutante (adalimumab) (GUEPARD)<sup>93</sup> reported a significantly better EULAR response for ADA plus MTX than for MTX alone at 12 weeks' follow-up, but at 1-year follow-up, when both groups had undergone step-up therapy, the groups were responding similarly well. OPTimized treatment algorithm for patients with Early Rheumatoid Arthritis (OPERA)<sup>107</sup> reported similar EULAR responses for ADA plus MTX plus steroid and for MTX plus PBO plus steroid at the 1-year follow-up. GOLimumab in active rheumatoid arthritis BEFORE methotrexate therapy (GO-BEFORE),<sup>90</sup> at 24 weeks, reported a significantly better EULAR response for GOL plus MTX and for PBO plus MTX, but at the 1-year follow-up the groups were doing similarly well. GO-BEFORE<sup>90</sup> contributed EULAR data to the NMA, whereas the others did not report data within 22–30 weeks' follow-up.

TABLE 9 Population characteristics: populations 2 and 3 – biologic head-to-head RCTs

Trial name/study	Treatment arms	Mean age (years) (SD)	Sex (% female)	Early withdrawal plan reported?	Disease duration (years) (SD)	Mean DAS28 at baseline (SD) – ESR unless stated to be CRP
ATTEST <sup>74</sup>	PBO + MTX (n = 110)	49.4 (11.5)	87.3	NR	8.4 (8.6)	ESR 6.8 (1.0)
	IFX + MTX (n = 165) <sup>a</sup>	49.1 (12.0)	82.4		7.3 (6.2)	6.8 (0.9)
	ABT + MTX (n = 156) <sup>b</sup>	49.0 (12.5)	83.3		7.9 (8.5)	6.9 (1.0)
AMPLE <sup>66</sup>	ABT s.c. (n = 318)	51.4	81.4	NR	1.9	CRP 5.5
	ADA (n = 328)	51.0	82.3		1.7	CRP 5.5
RED-SEA <sup>114</sup>	ADA + cDMARDs (n = 60)	55.0	75	NR	7.0 (range 3.3–13.0)	5.6
	ETN50 + cDMARDs (n = 60)	53.2	70		5.5 (range 2.0–14.5)	5.8
ADACTA <sup>58</sup>	TCZ + PBO (n = 163)	54.4 (13.0)	79	Yes	7.3 (8.1)	6.7 (0.9)
	ADA + PBO (n = 163)	53.3 (12.4)	82		6.3 (6.9)	6.8 (0.9)
deFilippis <i>et al.</i> , 2006 <sup>85</sup>	ETN + MTX (n = 16)	44.7 (14.17)	NR	NR	NR	NR
	IFX + MTX (n = 16)	46.79 (10.9)	NR	NR	NR	NR

ADACTA, Adalimumab ACTemrA (tocilizumab) head-to-head-study; AMPLE, abatacept vs. adalimumab in biologic naive RA patients with background MTX; ATTEST, A Trial for Tolerability, Efficacy, and Safety in Treating Rheumatoid Arthritis (infliximab); ETN50, etanercept 50 mg once a week subcutaneously; NR, not reported; RED-SEA, a Randomised Efficacy and Discontinuation Study of Etanercept versus Adalimumab.

a IFX 3 mg/kg i.v. administered on days 1 (i.e. week 0), 15 (i.e. week 2), 43 (i.e. week 6) and 85 (i.e. week 12) and every 56 days (i.e. 8 weeks) thereafter (NB: licensed dose 3 mg/kg i.v. at weeks 0, 2, 6 and every 8 weeks thereafter, adjustments in dosage and frequency of administration permitted after week 12 in license) + MTX.

b ABT dosed according to weight: patients weighing < 60 kg, 60–100 kg, or > 100 kg received 500 mg, 750 mg or 1000 mg of ABT respectively. ABT i.v. administered on days 1, 15 and 29 and every 28 days thereafter, up to and including day 337 + MTX.

Data are shown to the level of accuracy available in the source material.

TABLE 10 Population characteristics: populations 2 and 3 – cDMARD experienced vs. cDMARD(s) or PBO

Trial name/study	Treatment arms	Mean age (years) (SD)	Sex (% female)	Early withdrawal plan reported?	Disease duration (years) (SD)	Mean DAS28 at baseline (SD) – ESR unless stated to be CRP
AIM <sup>61,62</sup>	MTX + PBO (n = 219) ABT i.v. + MTX (n = 433)	50.4 51.5	81.7 77.8	NR	8.9 (7.1) 8.5 (7.3)	CRP 6.4 (0.1) CRP 6.4 (0.08)
ASSET <sup>72</sup>	PBO + MTX (n = 23) ABT i.v. (≈10 mg/kg) + MTX (n = 27)	52.5 (11.5) 51.7 (11.2)	69.6 59.3	NR	2.4 (1.4) 2.1 (1.5)	CRP 5.3 (0.9) CRP 5.3 (1.1)
ASSURE <sup>73</sup>	PBO + cDMARDs (n = 482) ABT + cDMARDs (n = 959)	52.0 (12.1) 52.2 (11.8)	83.7 83.1	NR	9.5 (9.1) 9.5 (8.7)	NR NR
AUGUST II <sup>76</sup>	MTX + PBO (n = 76) ADA + MTX (n = 79)	54 53	84 81	NR	8.4 8.8	5.8 5.8
CHANGE <sup>80</sup>	PBO (n = 87) ADA (n = 91)	53.4 56.9	77 79.1	Yes	8.4 9.9	NR NR
DE019 <sup>84</sup>	MTX + PBO (n = 200) ADA + MTX (n = 207)	56.1 56.1	73 76.3	Yes	10.9 11	NR NR
STAR <sup>117</sup>	PBO + cDMARDs (n = 318) ADA + cDMARDs (n = 318)	55.8 55	79.2 79.6	NR	11.5 9.3	NR NR
Van De Putte <i>et al.</i> , 2004 <sup>122</sup>	PBO s.c. (n = 110) ADA monotherapy (n = 113)	53.5 (13.2) 52.7 (13.3)	77.3 79.6	Yes	11.6 (9.3) 10.6 (6.9)	7.09 (0.87) 7.07 (0.86)
ARMADA <sup>69</sup>	MTX + PBO (n = 62) ADA + MTX (n = 67)	56 57.2	82.3 74.6	Yes	11.1 12.2	NR NR
Kim <i>et al.</i> , 2007 <sup>99</sup>	MTX + PBO rescue week 18 (n = 65) ADA + MTX (n = 63)	49.8 48.5	85.7 95.4	Yes	6.9 6.8	NR NR

continued

TABLE 10 Population characteristics: populations 2 and 3 – cDMARD experienced vs. cDMARD(s) or PBO (continued)

Trial name/study	Treatment arms	Mean age (years) (SD)	Sex (% female)	Early withdrawal plan reported?	Disease duration (years) (SD)	Mean DAS28 at baseline (SD) – ESR unless stated to be CRP
CERTAIN <sup>79</sup>	PBO + cDMARDs (n = 98) CTZ + DMARDs (n = 96)	54.0 (12.4) 53.6 (11.9)	76.5 84.4	Yes	4.7 (3.3) 4.5 (3.5)	ESR 4.47 (0.34) ESR 4.53 (0.43)
REALISTIC <sup>113</sup>	PBO + existing cDMARDs (biologic-naïve subgroup) (n = 29)	NR 53.9 (12.7) (overall trial population, n = 212)	79.7 (overall trial population, n = 212)	NR No (N/A as trial only 12 weeks)	8.9 (9.1) (overall trial population, n = 212)	DAS28-ESR 6.4 (0.9); DAS28-CRP 5.7 (0.9) (Overall trial population, n = 212)
	CTZ existing cDMARDs (biologic-naïve subgroup) (n = 134)	55.4 (12.4) (overall trial population, n = 851)	77.6 (overall trial population, n = 851)		8.6 (8.8) (overall trial population, n = 851)	DAS28-ESR 6.4 (0.9); DAS28-CRP 5.7 (0.9) (Overall trial population, n = 851)
ADORE <sup>59,60</sup>	ETN (n = 159)	53	79.2	NR	10.0	6.2
	ETN + MTX (n = 155)	54	76.8		9.8	6.3
CREATE IIb <sup>96</sup>	DMARD + PBO (n = 65)	51.5	83.1	NR	8.2 (7.59)	6.3 (0.76)
	ETN50 + DMARD (n = 64)	51.2	85.9		7.9 (7.15)	6.4 (0.85)
Combe et al., 2006, <sup>88</sup> Combe et al., 2009 <sup>89</sup>	SSZ + PBO (n = 50)	53.3	82	NR	5.6	DAS44-ESR 5.0
	ETN + PBO (n = 103)	51.3	78.6		7.1	DAS44-ESR 5.1
	ETN + SSZ (n = 101)	50.6	80.2		6.5	DAS44-ESR 5.2
JESMR <sup>140</sup>	ETN (n = 74)	58.1 (12.6)	87.3	NR	10.6 (10.5)	6.1
	ETN + MTX 6–8 mg/week (n = 77)	56.5 (11.1)	80.0		8.1 (7.7)	6.0
Lan et al., 2004 <sup>101</sup>	PBO + MTX (n = 29)	50.79	90	NR	NR (eligibility more than one year)	NR
	ETN + MTX (n = 29)	47.55	83			NR

Trial name/study	Treatment arms	Mean age (years) (SD)	Sex (% female)	Early withdrawal plan reported?	Disease duration (years) (SD)	Mean DAS28 at baseline (SD) – ESR unless stated to be CRP
LARA <sup>102</sup>	MTX + DMARD (n = 142) ETN50 + MTX (n = 281)	48.6 48.4	90.1 88.3	NR	9.0 (7.5) 7.9 (7.0)	5.9 5.9
Moreland <i>et al.</i> , 1999 <sup>104</sup>	PBO (n = 800) ETN + PBO (n = 78)	51 53	76 74	NR	12 11	NR NR
O'Dell <i>et al.</i> , 2013 <sup>112</sup>	MTX + SSZ + HCQ (n = 178) ETN50 + MTX (n = 175)	57.8 (13) 56 (13.2)	43.4 48.9	Yes	5.5 (9.3) 4.9 (8.0)	5.8 5.9
Wajidula 2000 (reported in Chen <i>et al.</i> , 2006 <sup>123</sup> )	PBO (n = 111) ETN (n = 105)	53 53	NR NR	N/A (12 week study)	7.2 7.5	NR NR
Weinblatt <i>et al.</i> , 1999 <sup>124</sup>	MTX + PBO (n = 30) ETN + MTX (n = 59)	53 48	73 90	Yes	13 13	NR NR
APPEAL <sup>67</sup>	MTX + DMARD (SSZ, HCQ or LEF) (n = 103) ETN + MTX (n = 197)	48.5 (11.3) 48.4 (12.0)	88.4 91.4	NR	6.9 (8.5) 6.5 (7.3)	ESR 6.1 (1.1); CRP 5.34 (1.1) ESR 6.1 (1.1); CRP 5.23 (1.1)
GO-FORTH <sup>91</sup>	PBO + MTX 6–8 mg/week (n = 90) GOL + MTX 6–8 mg/week (n = 89)	51.1 (11.6) 50.4 (9.9)	83.0 84.9	Yes	8.7 (8.2) 8.8 (8.8)	ESR 5.6 (0.99) ESR 5.5 (1.18)
GO-FORWARD <sup>92</sup>	PBO + MTX (n = 133) GOL + MTX (n = 89)	Mean (SD) = 51.2 (11.96) 52.0 (42.0–58.0) <sup>a</sup> Mean (SD) = 50.3 (10.98)	82.0 (109/133) 80.9 (72/89)	Yes	Mean (SD) = 8.62 (7.86) 6.5 (3.1–11.9) <sup>a</sup> Mean (SD) = 7.33 (7.83)	CRP 5.458 (4.672–6.093) <sup>a</sup> , ESR 6.111 (5.260–6.574) <sup>a</sup> CRP 5.766 (4.628–6.322) <sup>a</sup>
		52.0 (43.0–57.0) <sup>a</sup>			4.5 (2.1–9.7) <sup>a</sup>	

continued

TABLE 10 Population characteristics: populations 2 and 3 – cDMARD experienced vs. cDMARD(s) or PBO (continued)

Trial name/study	Treatment arms	Mean age (years) (SD)	Sex (% female)	Early withdrawal plan reported?	Disease duration (years) (SD)	Mean DAS28 at baseline (SD) – ESR unless stated to be CRP
Kay <i>et al.</i> , 2008 <sup>98</sup>	PBO s.c. + MTX (n = 35)	(46.0–66.0) <sup>a</sup>	74.3	Yes	5.6 (1.4–10.9) <sup>a</sup>	CRP 5.8 (5.2–6.4), <sup>a</sup> ESR 6.3 (5.7–7.0) <sup>a</sup>
Abe <i>et al.</i> , 2006 <sup>56</sup>	GOL + MTX (n = 35)	57.0 (50.0–64.0) <sup>a</sup>	85.7		8.2 (4.1–14.3) <sup>a</sup>	CRP 5.9 (5.5–6.9), <sup>a</sup> ESR 6.4 (5.6–7.3) <sup>a</sup>
	PBO + MTX (n = 47)	55.1 (7.6)	74.5 (35/47)	NR	7.5 (5.0)	NR
	IFX + MTX (n = 49)	55.2 (10.9)	81.6 (40/49)		9.1 (7.4)	NR
ATTRACT <sup>75</sup>	PBO + MTX (n = 88)	51 (19.0–75.0) <sup>a</sup>	80 (70/88)	NR	8.9 (0.8–35.0) <sup>b</sup>	NR
	IFX + MTX (n = 86)	56 (25.0–74.0) <sup>a</sup>	81 (70/86)		8.4 (0.7–45.0) <sup>b</sup>	NR
Durez <i>et al.</i> , 2004 <sup>86</sup>	Single i.v. infusion of MP (sodium hemisuccinate) at week 0 + MTX (n = 15)	56 (35–79) <sup>b</sup>	73	NR	12 (1–24) <sup>b</sup>	NR
	IFX + MTX (n = 12)	48 (34–60) <sup>b</sup>	100		10 (2–20) <sup>b</sup>	NR
START <sup>118</sup>	PBO + MTX (n = 363)	52.0 (44–61) <sup>a</sup>	83.2	Yes	8.4 (4–15) <sup>a</sup>	NR
	IFX + MTX (n = 360)	53.0 (45–61) <sup>a</sup>	80.0		7.8 (3–15) <sup>a</sup>	NR
Swefoot <sup>119</sup>	SSZ + HCQ + MTX (n = 130)	52.9 (13.9)	78 (101/130)	Yes	0.525	4.79 (1.05)
	IFX + MTX (n = 128)	51.1 (13.3)	76 (97/128)		0.517	4.91 (0.98)
Wong <i>et al.</i> , 2009 <sup>125</sup>	PBO + MTX (with crossover to open-label IFX at week 24) (n = 9)	50 (16)	8/9	Yes	NR	6.4 (0.8)
	IFX + MTX (n = 17)	48 (12)	14/17		NR	6.2 (0.9)
Zhang <i>et al.</i> , 2006 <sup>126</sup>	PBO + MTX (n = 86)	48.9 (8.0)	84.9	NR	8 (6.22)	NR
	IFX + MTX (n = 87)	47.9 (10.1)	85.1		7.13 (6.17)	NR
ACT-RAY <sup>57</sup>	TCZ + PBO (n = 277)	53.6 (11.9)	78.6	NR	8.3 (8.4)	ESR 6.36 (1.00)
	TCZ + MTX (n = 276)	53.0 (13.4)	81.9		8.2 (8.0)	ESR 6.33 (0.98)



Trial name/study	Treatment arms	Mean age (years) (SD)	Sex (% female)	Early withdrawal plan reported?	Disease duration (years) (SD)	Mean DAS28 at baseline (SD) – ESR unless stated to be CRP
MEASURE <sup>103</sup>	PBO + MTX (n = 69) TCZ + MTX (n = 69)	NR NR	NR NR	Yes NR	NR NR	NR NR
Nishimoto <i>et al.</i> , 2004 <sup>106</sup>	PBO (n = 53) TCZ monotherapy (n = 55)	53.0 (31–73) <sup>b</sup> 56.0 (25–74) <sup>b</sup>	73.6 83.6	NR	8.4 (0.7–52.7) <sup>b</sup> 8.3 (1.3–45.7) <sup>b</sup>	NR NR
SAMURAI <sup>115</sup>	cDMARDs (n = 145) TCZ monotherapy (n = 157)	53.1 52.9	82 79.6	NR	124.8 weeks 114.4 weeks	6.4 6.5
SATORI <sup>116</sup>	PBO + MTX (n = 64) TCZ + PBO (n = 61)	50.8 (12.2) 52.6 (10.6)	48/64 evaluated 90.2	NR	8.7 (7.1) 8.5 (8.4)	6.2 (0.9) 6.1 (0.9)
TOWARD <sup>121</sup>	PBO + stable cDMARDs (n = 415) TCZ + stable DMARDs (n = 805)	54 (13) 53 (13)	84 81	Yes	9.8 (9.1) 9.8 (8.8)	6.6 (1.0) 6.7 (1.0)
TACIT <sup>141</sup>	AiC information has been removed AiC information has been removed	AiC information has been removed AiC information has been removed	AiC information has been removed AiC information has been removed	AiC information has been removed AiC information has been removed	AiC information has been removed AiC information has been removed	AiC information has been removed AiC information has been removed

ACT-RAY, ACTemra (tocilizumab) Radiographic study; ADORE, Adjuvant Oxaliplatin in Rectal Cancer; AIM, Abatacept in Inadequate responders to Methotrexate; APPEAL, Asia-Pacific Study in Patients to be Treated With Etanercept or an Alternative Listed; ARMADA, Anti-TNF factor Research study program of the Monoclonal antibody Adalimumab (D2E7) in rheumatoid Arthritis; ASSET, Abatacept Systemic Sclerosis Trial; ASSURE, Abatacept Study of Safety in Use with other RA Therapies; ATTRACT, Anti-TNF trial in Rheumatoid Arthritis with Concomitant Therapy; AUGUST II, A Phase II Dose-finding Study of Atacicept in Rheumatoid Arthritis (RA); CERTAIN, efficacy and safety of CERTolizumab pegol After INcomplete response to DMARDs in RA patients with low to moderate disease activity; CHANGE, Clinical investigation in Highly disease-affected rheumatoid Arthritis patients in Japan with Adalimumab applying stanNard and General Evaluation study; CREATE II, A 6-month Randomised, Double-blind, Open Arm Comparator, Phase IIb With AZD9056, in Patients With Rheumatoid Arthritis (RA); DAS44, Disease Activity Score 44 joints; DE019, Efficacy and Safety of Adalimumab in Patients With Active Rheumatoid Arthritis Treated Concomitantly With Methotrexate; ETN50, etanercept 50 mg once a week subcutaneously; GO-FORTH, golimumab in combination with methotrexate in Japanese patients with active rheumatoid arthritis; GO-FORWARD, golimumab in active rheumatoid arthritis despite methotrexate therapy; JESMR, Japanese Efficacy and Safety of Etanercept on Active Rheumatoid Arthritis Despite Methotrexate Therapy; LARA, Latin American Rheumatoid Arthritis study; MEASURE, secukinumab in ankylosing spondylitis; MP, methylprednisolone; N/A, not applicable; NR, not reported; REALISTIC, RA Evaluation in Subjects receiving TNF Inhibitor Certolizumab pegol; Study of Active Controlled Monotherapy Used for Rheumatoid Arthritis, an IL-6 Inhibitor; SATORI, Study of Active controlled Tocilizumab for Rheumatoid arthritis patients with an inadequate response to methotrexate; STAR, Safety Trial of Adalimumab in Rheumatoid arthritis; START, Safety Trial for rheumatoid Arthritis with Remicade Therapy; Swefot, Swedish pharmacotherapy; TACIT, tumour necrosis factor inhibitors against combination intensive therapy; TOWARD, Tocilizumab in combination With traditional DMARD therapy.

a Median (interquartile range).  
b Median (range).  
Data are shown to the level of accuracy available in the source material.

TABLE 11 American College of Rheumatology response data: population 1 – RCTs of biologic vs. DMARD(s) or PBO

Trial name/study	Treatment arms for which data extraction performed	Assessment time point	Numbers analysed	% achieving ACR20 response	% achieving ACR50 response	% achieving ACR70 response	Data used in NMA?
Bejarano <i>et al.</i> , 2008 <sup>77</sup>	PBO + MTX	56 weeks	73	54.8	45.2	37.5	No
	ADA + MTX		75	71.6	56.0	50.7	
GUEPARD <sup>93</sup>	Initial MTX 12 weeks, then step-up therapy in both groups based on DAS28	12 weeks	32	50	27	19	No
	Initial ADA + MTX 12 weeks, then step-up therapy in both groups based on DAS28		33	84	66	44	
GUEPARD <sup>93</sup>	Initial MTX 12 weeks, then step-up therapy in both groups based on DAS28	52 weeks	32	81	68	58	No
	Initial ADA+MTX 12 weeks, then step-up therapy in both groups based on DAS28		33	85	67	42	
HIT HARD <sup>94</sup>	PBO + MTX	24 weeks	85	67.6	48.7	26.8	Yes
	ADA + MTX		87	79.0	63.8	48.0 <sup>a</sup>	
OPERA <sup>107</sup>	PBO + MTX + steroid	12 months	91	78	63	45	No
	ADA + MTX + steroid		89	86	80 <sup>a</sup>	65 <sup>a</sup>	
OPTIMA <sup>142</sup>	PBO + MTX	26 weeks	517	57	34	17	Yes
	ADA + MTX		515	70 <sup>b</sup>	52 <sup>b</sup>	35 <sup>b</sup>	
PREMIER <sup>109</sup>	PBO + MTX	26 weeks	257	61.5	40.5	22.2	Yes
	ADA monotherapy + PBO		274	53.3	35.0	19.7	
(Supplementary data identified via ClinicalTrials.gov)	ADA + MTX		268	68.7	58.6	42.5	

Trial name/study	Treatment arms for which data extraction performed	Assessment time point	Numbers analysed	% achieving ACR20 response	% achieving ACR50 response	% achieving ACR70 response	Data used in NMA?
PREMIER <sup>109</sup>	PBO + MTX	1 year	257	63	46	28	No
	ADA monotherapy + PBO		274	54 <sup>a</sup> (vs. MTX monotherapy)	41	26	
	ADA + MTX		268	73 <sup>a</sup> (vs. MTX monotherapy), b (vs. ADA monotherapy)	62 <sup>b</sup>	46 <sup>b</sup>	
	PBO + MTX	2 years	257	56	43	28	No
	ADA monotherapy + PBO		274	49	37	28	
	ADA + MTX		268	69 <sup>a</sup> (vs. MTX monotherapy), b (vs. ADA monotherapy)	59 <sup>b</sup>	47 <sup>b</sup>	
COMET <sup>81</sup>	PBO + MTX	24 weeks	268	169	102	47	Yes
	ETN + MTX		274	224	167	103	
	PBO + MTX	52 weeks	268	67	49	28	No
	ETN + MTX		274	86	71	48 <sup>b</sup>	
	MTX in year 1, MTX in year 2	2 years (week 104)	99	61	46	32	No
	MTX year 1, ETN + MTX in year 2		90	81 <sup>a</sup>	66 <sup>a</sup>	48 <sup>a</sup>	
ERA <sup>139</sup>	ETN + MTX in year 1, ETN + MTX in year 2		111	86 <sup>a</sup>	70 <sup>a</sup>	57 <sup>b</sup>	
	ETN + MTX in year 1, ETN in year 2		111	80	64	44	
	PBO + MTX	6 months	217	58.2	31.54	14.24	Yes
	ETN + PBO		207	65.42	40.14	20.94 <sup>a</sup>	
	PBO + MTX	12 months	217	66 <sup>c</sup>	44 <sup>c</sup>	23 <sup>c</sup>	No
	ETN + PBO		207	72 <sup>c</sup>	49 <sup>c</sup>	26 <sup>c</sup>	
GO-BEFORE <sup>90</sup>	PBO + MTX	24 weeks	160	49.4	29.4	15.6	Yes
	GOL + MTX		159	61.6 <sup>a</sup>	40.3 <sup>a</sup>	23.9	
GO-BEFORE <sup>143</sup>	PBO + MTX	52 weeks	160	63.1	40.6	24.4	No
	GOL + MTX		159	68.6	43.4	28.3	

continued

TABLE 11 American College of Rheumatology response data: population 1 – RCTs of biologic vs. DMARD(s) or PBO (continued)

Trial name/study	Treatment arms for which data extraction performed	Assessment time point	Numbers analysed	% achieving ACR20 response	% achieving ACR50 response	% achieving ACR70 response	Data used in NMA?
ASPIRE <sup>71</sup>	PBO + MTX	54 weeks	274	53.6	32.1	21.2	No
	IFX + MTX		351	62.4a	45.6 <sup>b</sup>	32.5 <sup>a</sup>	
BeST <sup>78</sup>	Sequential monotherapy	6 months	126	49.69	NR	15.9	Yes
	Step-up combination therapy		121	60.04	NR	11.77	
	Initial combination therapy + prednisone		133	70.63	NR	26.58	
	Initial combination therapy + IFX		128	74.3	NR	31.15	
Durez <i>et al.</i> , 2007 <sup>120</sup>	MTX	22 weeks	14	28.13	7.69	0	Yes
	MTX + i.v. MP	N/A	N/A	N/A	N/A	N/A	
	IFX + MTX	22 weeks	15	86.72 <sup>a</sup>	66.85 <sup>a</sup>	33.79 <sup>a</sup>	
	MTX	52 weeks	14	46 <sup>c</sup>	39 <sup>c</sup>	14 <sup>c</sup>	No
	MTX + i.v. MP		15	87 <sup>c</sup>	67 <sup>c</sup>	53 <sup>c</sup>	
	IFX + MTX		15	80 <sup>c</sup>	65 <sup>c</sup>	29 <sup>c</sup>	
	PBO + MTX	14 weeks	10	20	0	0	No
	IFX + MTX		10	60	60	60	
Quinn <i>et al.</i> , 2005 <sup>110</sup>	PBO + MTX	54 weeks	10	60	40	30	No
	IFX + MTX		10	80	80	70	

ASPIRE, Active controlled Study of Patients receiving Infliximab for the treatment of Rheumatoid arthritis of Early onset; BeST, BEhandlings STRategie; COMET, Combination Of METHotrexate and etabercept in early rheumatoid arthritis; ERA, Early Rheumatoid Arthritis (etanercept); GO-BEFORE, GOLimumab in active rheumatoid arthritis BEFORE methotrexate therapy; GUEPARD, GUErir la PolyARthrite rheumatoide Débutante (adalimumab); HIT HARD, High Induction Therapy with Anti-Rheumatic Drugs (adalimumab and methotrexate); MP, methylprednisolone; N/A, not applicable; NR, not reported; OPERA, Optimized treatment algorithm for patients with Early Rheumatoid Arthritis; OPTIMA, OPTimal protocol for treatment initiation with Methotrexate and Adalimumab; PREMIER, Patients REceiving Methotrexate and Infliximab for the treatment of Early Rheumatoid arthritis.

a  $p < 0.05$ .

b  $p < 0.001$ .

c Estimated from graphical data.

Data are shown to the level of accuracy available in the source material.

TABLE 12 American College of Rheumatology response data: populations 2 and 3 – biologic head-to-head RCTs

Trial name/study	Treatment arms for which data extraction performed	Assessment time point	Numbers analysed	% achieving ACR20 response	% achieving ACR50 response	% achieving ACR70 response	Data used in NMA?
ATTEST <sup>74</sup>	PBO + MTX	Day 197	110	41.8	20	9.1	Yes
	IFX + MTX	Day 197	165	59.4 <sup>a</sup> (vs. PBO)	37 <sup>a</sup> (vs. PBO)	24.2 <sup>a</sup> (vs. PBO)	
	ABT i.v. + MTX	Day 197	156	66.7 <sup>b</sup> (vs. PBO)	40.4 <sup>b</sup> (vs. PBO)	20.5 <sup>a</sup> (vs. PBO)	
AMPLE <sup>66</sup>	ABT s.c.	28 weeks (197 days)	328	66.13	45.7	24.19	Yes
	ADA	28 weeks (197 days)	318	64.52	42.47	22.58	
AMPLE <sup>144</sup>	ABT s.c.	1 year	328	64.8	46.2	29.2	No
	ADA	1 year	318	63.4	46	26.2	
ADACTA <sup>58</sup>	TCZ + s.c. PBO	24 weeks	163	65.0 <sup>a</sup>	47.2 <sup>a</sup>	32.5 <sup>a</sup>	Yes
	ADA + i.v. PBO	24 weeks	162	49.4	27.8	17.9	
deFilippis <i>et al.</i> , 2006 <sup>85</sup>	ETN + MTX	22 weeks	15	60	26	7	Yes
	IFX + MTX	22 weeks	15	60	33	7	
	ETN + MTX	54 weeks	15	74	53	7	No
	IFX + MTX	54 weeks	15	60	19	20	

AMPLE, abatacept vs. adalimumab in biologic-naive RA patients with background MTX.

a  $p < 0.05$ .

b  $p < 0.001$ .

Data are shown to the level of accuracy available in the source material.

TABLE 13 American College of Rheumatology response data: populations 2 and 3 – RCTs of biologic vs. DMARD(s) or PBO

Trial name/study	Treatment arms for which data extraction performed	Assessment time point	Numbers analysed	% achieving ACR20 response	% achieving ACR50 response	% achieving ACR70 response	Data used in NMA?
AIM <sup>62</sup>	PBO+MTX	6 months	219	39.7	16.8	6.5	Yes
	ABT i.v. + MTX		433	67.9	39.9	19.8	
	PBO + MTX	12 months	219	39.7	18.2	6.1	No
	ABT i.v. + MTX		433	73.1	48.3	28.8	
AUGUST II <sup>76</sup>	PBO+MTX	26 weeks	76	46	15	5	Yes
	ADA + MTX		79	71 <sup>b</sup>	38 <sup>b</sup>	18 <sup>a</sup>	
CHANGE <sup>80</sup>	PBO	24 weeks	87	13.8	5.7	1.1	Yes
	ADA monotherapy		91	44	24.2	12.1	
DE019 <sup>84</sup>	PBO+MTX	24 weeks	200	29.5	9.5	2.5	Yes
	ADA + MTX		207	63.3	39.1	20.8	
	PBO + MTX	52 weeks	200	24.0	9.5	4.5	No
	ADA + MTX		207	58.9 <sup>b</sup>	41.5 <sup>b</sup>	23.2 <sup>b</sup>	
STAR <sup>117</sup>	PBO + cDMARDs	24 weeks	318	34.9	11.3	3.5	Yes
	ADA + cDMARDs		318	52.8 <sup>a</sup>	28.9 <sup>a</sup>	14.8 <sup>a</sup>	
Van De Putte <i>et al.</i> , 2004 <sup>122</sup>	PBO s.c.	26 weeks	110	19.1	8.2	1.8	Yes
	ADA monotherapy		113	46.0 <sup>b</sup>	22.1 <sup>a</sup>	12.4 <sup>a</sup>	
ARMADA <sup>69</sup>	PBO + MTX	24 weeks	62	14.5	8.1	4.8	Yes
	ADA + MTX		67	67.2	55.2	26.9	
Kim <i>et al.</i> , 2007 <sup>99</sup>	PBO + MTX	24 weeks	63	36.5	14.3	7.9	Yes
	ADA + MTX		65	61.5	43.1	21.5	
CERTAIN <sup>79</sup>	PBO + cDMARDs	24 weeks	98	15.3	7.1	3.1	Yes
	CTZ + DMARDs		96	36.5 <sup>a</sup>	20.8 <sup>a</sup>	9.4	

Trial name/study	Treatment arms for which data extraction performed	Assessment time point	Numbers analysed	% achieving ACR20 response	% achieving ACR50 response	% achieving ACR70 response	Data used in NMA?
REALISTIC <sup>113</sup>	PBO + existing cDMARDs	12 weeks	29	20.7	NR	NR	No
	CTZ + existing cDMARDs		134	54.5	NR	NR	
ADORE <sup>59,60</sup>	ETN monotherapy	16 weeks	155	71.0	41.9	17.4	No
	ETN + MTX		152	67.1	40.1	18.4	
CREATE IIb <sup>96,145</sup>	PBO + DMARD	24 weeks	65	32.3	16.9	4.6	Yes
	ETN50 + DMARD		64	65.6	46.9	23.4	
ETN study 309 <sup>89</sup>	PBO + SSZ	24 weeks	50	28.0	14.0	2.0	Yes
	ETN + PBO		103	73.8 <sup>a</sup> (vs. SSZ)	46.6	21.4	
	ETN + SSZ		101	74.0 <sup>a</sup> (vs. SSZ, NS vs. ETN+PBO)	52.0 <sup>a</sup> (vs. SSZ, NS vs. ETN+PBO)	25.0 <sup>a</sup> (vs. SSZ, NS vs. ETN+PBO)	
JESMR <sup>140</sup>	PBO + SSZ	104 weeks	50	34	10 <sup>c</sup>	2 <sup>c</sup>	No
	ETN + PBO		103	67 <sup>a</sup> (vs. SSZ)	45 <sup>a</sup> (vs. SSZ), <sup>c</sup>	24 <sup>a</sup> (vs. SSZ), <sup>c</sup>	
	ETN + SSZ		101	77 <sup>a</sup> (vs. SSZ)	58 <sup>a</sup> (vs. SSZ), <sup>c</sup>	27 <sup>a</sup> (vs. SSZ), <sup>c</sup>	
	ETN monotherapy	24 weeks	69	63.8	47.8	26.1	Yes
	ETN + MTX		73	90.4 <sup>b</sup>	64.4	38.4	
	ETN monotherapy	52 weeks	69	63.8	43.5	29	No
	ETN + MTX		73	86.3 <sup>b</sup>	76.7 <sup>b</sup>	50.7 <sup>a</sup>	
Lan <i>et al.</i> , 2004 <sup>101</sup>	PBO + MTX	12 weeks	29	34	10	0	No
	ETN + MTX		29	90 <sup>b</sup>	66 <sup>b</sup>	24	
LARA <sup>102</sup>	MTX + DMARD	24 weeks	142	50	23.2	11.3	Yes
	ETN50 + MTX		279	83.2 <sup>b</sup>	62 <sup>b</sup>	34.8 <sup>b</sup>	

continued

**TABLE 13** American College of Rheumatology response data: populations 2 and 3 – RCTs of biologic vs. DMARD(s) or PBO (*continued*)

Trial name/study	Treatment arms for which data extraction performed	Assessment time point	Numbers analysed	% achieving ACR20 response	% achieving ACR50 response	% achieving ACR70 response	Data used in NMA?
Moreland <i>et al.</i> , 1999, <sup>104</sup> Mathias <i>et al.</i> , 2000 <sup>105</sup>	PBO	3 months	80	23	8	4	No
	ETN + PBO		78	62 <sup>b</sup>	41 <sup>b</sup>	15 <sup>a</sup>	
	PBO	6 months	80	11	5	1	Yes
	ETN + PBO		78	59 <sup>b</sup>	40 <sup>b</sup>	15 <sup>b</sup>	
	MTX + SSZ + HCQ	24 weeks	159	55.97	25.79	5.03	Yes
RACAT <sup>111</sup>	ETN50 + MTX		163	55.21	35.58	15.95 <sup>a</sup>	
	MTX + SSZ + HCQ	48 weeks	154	57.4	35.5	18.1	No
	In analysis, <i>n</i> = 154 (of whom 39 switched to ETN)						
	ETN50 + MTX ( <i>n</i> = 175)		155	65.8	42.6	26.5	
	In analysis, <i>n</i> = 155 (of whom 41 switched to MTX + SSZ + HCQ)						
Wajdula 2000 (reported in Chen <i>et al.</i> , 2006 <sup>123</sup> )	PBO	12 weeks	100	12	5	1	No
	ETN		109	70	34	13	
Weinblatt <i>et al.</i> , 1999 <sup>124</sup>	PBO + MTX	24 weeks	30	27	3	0	Yes
	ETN + MTX		59	71 <sup>b</sup>	39 <sup>b</sup>	15 <sup>a</sup>	
APPEAL <sup>67</sup>	MTX + DMARD (SSZ, HCQ or LEF)	16 weeks	103	58	35	7	No
	ETN + MTX		197	79 <sup>b</sup>	57 <sup>b</sup>	19 <sup>a</sup>	
GO-FORTH <sup>91</sup>	PBO + MTX	14 weeks	88	27.3	9.1	2.3	No
	GOL + MTX		86	72.1 <sup>b</sup>	43.0 <sup>b</sup>	22.1 <sup>b</sup>	
	PBO + MTX	24 weeks	88	33.0	14.8	5.7	Yes
	GOL + MTX		86	70.9 <sup>b</sup>	41.9 <sup>b</sup>	26.7 <sup>b</sup>	



Trial name/study	Treatment arms for which data extraction performed	Assessment time point	Numbers analysed	% achieving ACR20 response	% achieving ACR50 response	% achieving ACR70 response	Data used in NMA?
GO-FORWARD <sup>92</sup>	PBO + MTX	14 weeks	133	33.1	9.8	3.8	No
	GOL + MTX		89	55.1 <sup>b</sup>	34.8 <sup>b</sup>	13.5 <sup>a</sup>	
	PBO + MTX	24 weeks	133	27.8	13.5	5.3	Yes
	GOL + MTX		89	59.6 <sup>b</sup>	37.1 <sup>b</sup>	20.2 <sup>b</sup>	
Kay <i>et al.</i> , 2008 <sup>98</sup>	PBO + MTX	16 weeks	35	37.1	5.7	0	No
	GOL + MTX		35	60.0	37.1 <sup>b</sup>	8.6	
Abe <i>et al.</i> , 2006 <sup>56</sup>	PBO + MTX	14 weeks	47	23.4	8.5	0	No
	IFX + MTX		49	61.2	30.6	10.2	
ATTRACT <sup>75</sup>	PBO + MTX	30 weeks	84	20	5	0	Yes
	IFX + MTX		83	50	27 <sup>b</sup>	8 <sup>a</sup>	
Lipsky <i>et al.</i> , 2000 <sup>146</sup>	PBO + MTX	54 week	88	17	8	2	No
	IFX + MTX		86	42 <sup>b</sup>	21 <sup>a</sup>	10 <sup>a</sup>	
Durez <i>et al.</i> , 2004 <sup>86</sup>	MP i.v. + MTX	14 weeks	12	8	0	0	No
	IFX + MTX		9	67 <sup>a</sup>	44 <sup>a</sup>	0	
Swefo <sup>t</sup> <sup>119</sup>	SSZ + HCQ + MTX	12 months after study inclusion [8–9 months (35–39 weeks) after randomisation]	130	28	15	7	No
	IFX + MTX		128	42 <sup>a</sup>	25 <sup>a</sup>	12	
Swefo <sup>t</sup> <sup>147</sup>	SSZ + HCQ + MTX	24 months after study inclusion [20–21 months (87–91 weeks) after randomisation]	130	33	22	14	No
	IFX + MTX		128	40	30	16	
START <sup>118</sup>	PBO + MTX	22 weeks	363	25.5	9.7	4.7	Yes
	IFX + MTX		360	58.0 <sup>b</sup>	32.1 <sup>b</sup>	14.0 <sup>b</sup>	
Zhang <i>et al.</i> , 2006 <sup>126</sup>	PBO + MTX	18 weeks	NR (86 randomised)	48.84	25.58	13.95	No
	IFX + MTX		NR (87 randomised)	75.86 <sup>b</sup>	43.68 <sup>a</sup>	22.99	

continued

TABLE 13 American College of Rheumatology response data: populations 2 and 3 – RCTs of biologic vs. DMARD(s) or PBO (continued)

Trial name/study	Treatment arms for which data extraction performed	Assessment time point	Numbers analysed	% achieving ACR20 response	% achieving ACR50 response	% achieving ACR70 response	Data used in NMA?
ACT-RAY <sup>57</sup>	TCZ + oral PBO	24 weeks	276	70.3	40.2	25.4	Yes
	TCZ + MTX		277	71.5	45.5	24.5	
MEASURE <sup>103</sup>	PBO + MTX	12 weeks	NR	25	6	3	No
	TCZ + MTX		NR	51	17	10	
Nishimoto <i>et al.</i> , 2004 <sup>106</sup>	PBO	12 weeks	53	11.3	1.9	0	No
	TCZ		55	78.2 <sup>b</sup>	40.0 <sup>b</sup>	16.4 <sup>a</sup>	
SAMURAI <sup>115</sup>	cDMARDs	24 weeks	145	38.67	17.64	6.86	Yes
	TCZ		157	82.06	57.27	33.82	
	cDMARDs	52 weeks	145	34	13	6	No
	TCZ		157	78 <sup>b</sup>	64 <sup>b</sup>	44 <sup>b</sup>	
SATORI <sup>116</sup>	PBO + MTX	24 weeks	64	25.0	10.9	6.3	Yes
	TCZ + PBO capsules		61	80.0	49.2	29.5	
TOWARD <sup>121</sup>	PBO + stable cDMARDs	24 weeks	413	24.5	9	2.9	Yes
	TCZ + stable DMARDs		803	60.8 <sup>b</sup>	37.6 <sup>b</sup>	20.5 <sup>b</sup>	

ACT-RAY, ACTemra (tocilizumab) Radiographic study; ADORE, Adjuvant Oxaliplatin in Rectal Cancer; AIM, Abatacept in Inadequate responders to Methotrexate; APPEAL, Asia-Pacific Study in Patients to be Treated With Etanercept or an Alternative Listed; ARMADA, Anti-TNF factor Research study program of the Monoclonal antibody Adalimumab (D2E7) in rheumatoid Arthritis; ATTRACT, Anti-TNF trial in Rheumatoid Arthritis with Concomitant Therapy; AUGUST II, A Phase II Dose-finding Study of Atacicept in Rheumatoid Arthritis (RA); CERTAIN, efficacy and safety of Certolizumab pegol After Incomplete response to DMARDs in RA patients with low to moderate disease activity; CHANGE, Clinical investigation in Highly disease-affected rheumatoid Arthritis patients in Japan with Adalimumab applying standard and General Evaluation study; CREATE IIb, A 6-month Randomised, Double-blind, Open Arm Comparator, Phase IIb With AZD9056, in Patients With Rheumatoid Arthritis (RA); DE019, Efficacy and Safety of Adalimumab in Patients With Active Rheumatoid Arthritis Treated Concomitantly With Methotrexate; ETN50, etanercept 50 mg once a week subcutaneously; GO-FORTH, golimumab in combination with methotrexate in Japanese patients with active rheumatoid arthritis; GO-FORWARD, golimumab in active rheumatoid arthritis despite methotrexate therapy; JESMR, Japanese Efficacy and Safety of Etanercept on Active Rheumatoid Arthritis Despite Methotrexate Therapy; LARA, Latin American Rheumatoid Arthritis study; MEASURE, secukinumab in ankylosing spondylitis; MP, methylprednisolone; NR, not reported; NS, non-significant; RACAT, Rheumatoid Arthritis Comparison of Active Therapies in Methotrexate Suboptimal Responders study; REALISTIC, RA Evaluation In Subjects receiving TNF Inhibitor Certolizumab pegol; SAMURAI, Study of Active controlled Monotherapy Used for Rheumatoid Arthritis, an IL-6 inhibitor; SATORI, Study of Active controlled Tocilizumab for Rheumatoid arthritis patients with an Inadequate response to methotrexate; STAR, Safety Trial of Adalimumab in Rheumatoid arthritis; START, Safety Trial for rheumatoid Arthritis with Remicade Therapy; Swefot, Swedish pharmacotherapy; TOWARD, Tocilizumab in combination With traditional DMARD therapy.

a  $p < 0.05$ .  
b  $p < 0.001$ .  
c Estimated from graphical data.  
Data are shown to the level of accuracy available in the source material.

TABLE 14 European League Against Rheumatism response: population 1 – RCTs of biologic vs. DMARD(s) or PBO

Trial name/ author, year	Treatment arms for which data extraction performed	Assessment time point	Numbers analysed	% achieving no EULAR response	% achieving moderate EULAR response	% achieving good EULAR response	% EULAR responder (moderate/good)	In NMA?
GUEPARD <sup>93</sup>	MTX	Week 12	32	NR	NR	25	NR	No
	ADA + MTX	Week 12	33	NR	NR	63.6 <sup>a</sup>	NR	No
	Initial MTX	Week 52	32	NR	NR	65.6	NR	No
	12 weeks, then step-up therapy							
	Initial ADA + MTX	Week 52	33	NR	NR	63.6	NR	No
	12 weeks, then step-up therapy							
OPERA <sup>107</sup>	MTX + PBO + steroid	12 months	91	7	20	74	94	No
	ADA + MTX + steroid	12 months	89	7	11	82	93	No
GO-BEFORE <sup>90</sup>	PBO + MTX	24 weeks	160	38.7	NR	NR	61.3	Yes
	GOL + MTX	24 weeks	159	27	NR	NR	73 <sup>a</sup>	Yes
GO-BEFORE <sup>143</sup>	PBO + MTX	52 weeks	160	25.6	NR	NR	74.4	No
	GOL + MTX	52 weeks	159	19.5	NR	NR	80.5	No

GO-BEFORE, GOLimumab in active rheumatoid arthritis BEFORE methotrexate therapy; GUEPARD, GUÉrir la polyArthrite rhéumatoïde Débutante (adalimumab); NR, not reported;  
OPERA, OPTimized treatment algorithm for patients with Early Rheumatoid Arthritis.  
a  $p < 0.05$ .  
Data are shown to the level of accuracy available in the source material.

**Populations 2 and 3** There were three trials of head-to-head biologics for cDMARD-experienced patients who reported EULAR response data (*Table 15*). ATTEST<sup>74</sup> showed that patients treated with ABT plus MTX or IFX plus MTX responded similarly at 6 months' follow-up. A Randomised Efficacy and Discontinuation Study of Etanercept versus Adalimumab (RED-SEA)<sup>114</sup> reported ADA plus cDMARDs and ETN (50 mg) once a week plus cDMARDs-treated patients responding similarly well at 1-year follow-up. ADACTA<sup>58</sup> reported that significantly more TCZ plus PBO-treated patients achieved a good EULAR response than ADA plus PBO-treated patients at 6 months' follow-up. ADACTA<sup>58</sup> and ATTEST<sup>74</sup> contributed EULAR data to the NMA, whereas RED-SEA<sup>114</sup> did not report data within 22–30 weeks' follow-up.

Eleven other published trials reported EULAR data for biologics (*Table 16*). With the exception of CTZ, data were available for all interventions of interest. Two ADA trials reported EULAR data. A Phase II Dose-finding Study of Atacicept in Rheumatoid Arthritis (RA) (AUGUST II)<sup>76</sup> reported a significantly better EULAR result for ADA plus MTX than for MTX plus PBO at 6 months. ADA monotherapy had a significantly higher percentage of patients achieving at least moderate EULAR response than a PBO arm.<sup>122</sup> Of four ETN trials, two compared ETN monotherapy with ETN combined with MTX. One of these studies<sup>59</sup> found similar EULAR responses for the groups at 16 weeks, whereas the other<sup>140</sup> reported significantly better results for combination therapy than for monotherapy at 6 months and 1 year. Latin American Rheumatoid Arthritis study (LARA)<sup>102</sup> reported significantly better EULAR response for ETN (50 mg) once a week plus MTX than for MTX in combination with either SSZ or HCQ at 6 months. ETN plus MTX had a similar percentage of participants with good or moderate EULAR response to MTX plus DMARD (SSZ, HCQ or LEF) in the Asia-Pacific Study in Patients to be Treated With Etanercept or an Alternative Listed (APPEAL)<sup>67</sup> trial at 16 weeks' follow-up. GOL plus MTX was significantly better than MTX plus PBO in terms of EULAR response at both 14 and 24 weeks' follow-up in the golimumab in active rheumatoid arthritis despite methotrexate therapy (GO-FORWARD)<sup>92</sup> trial. Swedish pharmacotherapy (Swefot)<sup>119</sup> reported IFX plus MTX having significantly better EULAR response than triple therapy with cDMARDs (SSZ + HCQ + MTX) at 1 year, with the difference between groups not significant at 6 months and 2 years. TCZ monotherapy was investigated in two of the three TCZ trials reporting EULAR data. TCZ monotherapy results were similar to TCZ in combination with MTX, in the ACTemra (tocilizumab) RAdiographic studY (ACT-RAY)<sup>57</sup> trial at 6 months. TCZ monotherapy treatment had significantly better EULAR responses at 12 weeks compared with PBO.<sup>106</sup> The Tocilizumab in combination With traditional DMARD therapy (TOWARD)<sup>121</sup> trial reported significantly better EULAR responses for TCZ in combination with stable cDMARDs than for PBO in combination with stable cDMARDs at 6 months. The following trials contributed EULAR data to the NMA: AUGUST II,<sup>76</sup> Van De Putte *et al.*,<sup>122</sup> Japanese Efficacy and Safety of Etanercept on Active Rheumatoid Arthritis Despite Methotrexate Therapy (JESMR),<sup>140</sup> LARA,<sup>102</sup> GO-FORWARD,<sup>92</sup> Swefot,<sup>119</sup> ACT-RAY<sup>57</sup> and TOWARD.<sup>121</sup> ADjuvant Oxaliplatin in REctal Cancer (ADORE)<sup>59</sup> and APPEAL<sup>67</sup> did not have data within 22–30 weeks.

(Academic-in-confidence information has been removed.)

### **Disease Activity Score 28 joints**

**Population 1** One head-to-head biologics trial in MTX-naive patients reported DAS28 data<sup>100</sup> (see *Appendix 4, Table 346*). At 24 weeks' follow-up, Kume *et al.*<sup>100</sup> reported similar mean change from baseline in DAS28-ESR for ADA monotherapy and ETN monotherapy.

TABLE 15 European League Against Rheumatism response: populations 2 and 3 – biologic head-to-head RCTs

Trial name/ study	Treatment arms for which data extraction performed	Assessment time point	Numbers analysed	% achieving no EULAR response	% achieving moderate EULAR response	% achieving good EULAR response	% EULAR responder (moderate/good)	In NMA?
ATTEST <sup>74</sup>	PBO + MTX ABT + MTX	Day 197 Day 197	102 150	45.1 23.3	44.1 56.7	10.8 20.0	54.9 76.7	Yes Yes
RED-SEA <sup>114</sup>	IFX + MTX ADA + cDMARDs	Day 197 52 weeks	156 60	34.0 40.4	42.9 33.3	23.1 26.3	66.0 59.6	Yes No
ADACTA <sup>58</sup>	ETN50 + cDMARDs TCZ + PBO ADA + PBO	52 weeks 24 weeks 24 weeks	60 163 162	51.5 22.1 45.1	16.7 26.4 35.1	31.7 51.5 <sup>a</sup> 19.8	48.4 77.9 54.9	No Yes Yes

ETN50, etanercept 50 mg once a week subcutaneously; RED-SEA, a Randomised Efficacy and Discontinuation Study of Etanercept versus Adalimumab.  
a  $p < 0.01$  reported.

TABLE 16 European League Against Rheumatism: populations 2 and 3 – RCTs of biologic vs. DMARD(s) or PBO

Trial name/ study	Treatment arms for which data extraction performed	Assessment time point	Numbers analysed	% achieving no EULAR response	% achieving moderate EULAR response	% achieving good EULAR response	% EULAR responder (moderate/good)	In NMA?
AUGUST II <sup>76</sup>	MTX + PBO ADA + MTX	26 weeks	76 79	41 19	NR NR	NR NR	59 81 <sup>a</sup>	Yes Yes
Van De Putte <i>et al.</i> , 2004 <sup>122</sup>	PBO ADA	26 weeks	110 113	73.6 44.2	22.8 47.0	3.6 8.8	26.4 55.8	Yes Yes
ADORE <sup>59,60</sup>	ETN ETN + MTX	16 weeks	156 151	20.0 17.6	NR NR	NR NR	80.0 82.4	No No
JESMR <sup>140</sup>	ETN ETN + MTX 6–8 mg/week	24 weeks	69 73	29.0 4.1 <sup>b</sup>	37.7 43.8 <sup>c</sup>	33.3 52.1 <sup>c</sup>	71.0 95.9	Yes Yes
LARA <sup>102</sup>	ETN ETN + MTX 6–8 mg/week MTX + DMARD ETN50 + MTX	52 weeks 24 weeks	69 73 142	NR NR 35.2	NR NR NR	NR NR 12	NR NR 64.8	No No Yes
APPEAL <sup>67,68</sup>	MTX + DMARD (SSZ, HCQ or LEF) ETN + MTX	16 weeks	279 103 197	8.2 26.2 12.2	NR NR NR	47 <sup>c</sup> NR NR	91.8 <sup>c</sup> 73.8 87.8	Yes No No
GO-FORTH <sup>91</sup>	PBO + MTX GOL + MTX	6 months	84 81	51.2 16.0	35.7 37.0	13.1 46.9	48.8 84.0	Yes Yes

Trial name/ study	Treatment arms for which data extraction performed	Assessment time point	Numbers analysed	% achieving no EULAR response	% achieving moderate EULAR response	% achieving good EULAR response	% EULAR responder (moderate/good)	In NMA?
GO-FORWARD <sup>92</sup>	PBO + MTX	14 weeks	133	55.6	NR	NR	44.4	No
	GOL + MTX		89	29.2	NR	NR	70.8 <sup>c</sup>	No
	PBO + MTX	24 weeks	133	57.9	NR	NR	42.1	Yes
	GOL + MTX		89	28.1	NR	NR	71.9 <sup>c</sup>	Yes
START <sup>118</sup>	PBO + MTX	5.5 months	332	56	NR	NR	44	Yes
	IFX + MTX		333	25	NR	NR	75	Yes
Swefot <sup>119</sup>	SSZ + HCQ + MTX	23.8 weeks	130	NR	NR	23.8	NR	Yes
	IFX + MTX		128	NR	NR	33.6	NR	Yes
	SSZ + HCQ + MTX	12 months after study inclusion	130	51	NR	25	49	No
	IFX + MTX	[8–9 months (35–39 weeks) after randomisation]	128	40	NR	39 <sup>a</sup>	60	No
	SSZ + HCQ + MTX	24 months after study inclusion	130	50	NR	31	50	No
	IFX + MTX	[20–21 months (87–91 weeks) after randomisation]	128	41	NR	38	59	No
ACT-RAY <sup>57</sup>	TCZ + PBO	24 weeks	276	13.8	34.8	51.4	86.2	Yes
	TCZ + MTX		277	10.5	27.8	61.7	89.5	Yes
Nishimoto <i>et al.</i> , 2004 <sup>106</sup>	PBO	12 weeks	53	81.1	NR	0	18.9	No
	TCZ		55	9.1	NR	18.2 <sup>c</sup>	90.9 <sup>c</sup>	No
SATORI <sup>116</sup>	MTX	6 months	64	60.3	36.5	3.2	39.7	Yes
	TCZ		61	3.4	31.1	65.5	96.6	Yes

continued

TABLE 16 European League Against Rheumatism: populations 2 and 3 – RCTs of biologic vs. DMARD(s) or PBO (continued)

Trial name/ study	Treatment arms for which data extraction performed	Assessment time point	Numbers analysed	% achieving no EULAR response	% achieving moderate EULAR response	% achieving good EULAR response	% EULAR responder (moderate/good)	In NMA?
TOWARD <sup>121</sup>	PBO + stable cDMARDs	24 weeks	413	62.5	NR	NR	37.5	Yes
TACIT <sup>141</sup> (AiC)	TCZ + stable DMARDs		803	20.3	NR	NR	79.7 <sup>c</sup>	Yes
	Intensive DMARDs	(AiC information has been removed)	(AiC information has been removed)	(AiC information has been removed)	(AiC information has been removed)	(AiC information has been removed)	(AiC information has been removed)	Yes
	Grouped biologics	(AiC information has been removed)	(AiC information has been removed)	(AiC information has been removed)	(AiC information has been removed)	(AiC information has been removed)	(AiC information has been removed)	Yes

ETN50, etanercept 50 mg once a week subcutaneously; GO-FORTH, golimumab in combination with methotrexate in Japanese patients with active rheumatoid arthritis; NR, not reported; SATORI, Study of Active controlled Tocilizumab for Rheumatoid arthritis patients with an Inadequate response to methotrexate; START, Safety Trial for rheumatoid Arthritis with Remicade Therapy; TACIT, tumour necrosis factor inhibitors against combination intensive therapy.

a  $p < 0.05$  reported.

b  $p < 0.001$  reported.

c  $p < 0.01$  reported.



Thirteen other trials reported DAS28 mean change or remission data for MTX-naïve patient trials, comprising five ADA trials,<sup>93,94,107–109</sup> one ETN trial,<sup>81</sup> one GOL trial<sup>90</sup> and five IFX trials.<sup>71,78,86,95,110</sup> Across all interventions, where reported, mean DAS28 improved slightly in all treatment arms, including control cDMARD arms. Biologic treatment arms reported significantly higher percentage of patients meeting pre-defined DAS28 remission (usually < 2.6), or having significantly more improved DAS28 than baseline, than controls for ADA plus MTX than MTX plus PBO;<sup>94,109</sup> ADA plus MTX plus steroid than MTX plus PBO than steroid;<sup>107</sup> ETN plus MTX than MTX plus PBO;<sup>81</sup> GOL plus MTX than MTX plus PBO at 6 months (not 1-year follow-up);<sup>90</sup> IFX plus MTX than MTX plus PBO.<sup>71,110</sup> ADA monotherapy had similar DAS28 results to MTX plus PBO,<sup>109</sup> as did IFX plus MTX to MTX plus methylprednisolone (MP).<sup>86,95</sup> Step-up therapy with initial ADA<sup>93</sup> or IFX<sup>78</sup> did not differ from control groups after 1 year or 6 months respectively. Results are shown in *Appendix 4, Table 347*.

**Populations 2 and 3** Four head-to-head trials of cDMARD-experienced patients reported DAS28 results<sup>58,66,74,114</sup> (see *Appendix 4, Table 348*). ABT, ADA, ETN (50 mg) once weekly, IFX and TCZ treatment arms all showed some improvement in DAS28. There were similar levels of DAS28 improvement for ABT plus MTX and IFX plus MTX (both of which were significantly more improved than MTX plus PBO),<sup>74</sup> ABT and ADA monotherapies,<sup>66</sup> and ADA and ETN (50 mg) once weekly both in combination with cDMARDs.<sup>114</sup> ADACTA<sup>58</sup> reported significantly more improvement for TCZ monotherapy than for ADA monotherapy.

Twenty other trials reported DAS28 mean change or remission data for cDMARD-experienced patient trials (see *Appendix 4, Table 349*), comprising two ABT trials,<sup>62,72</sup> one ADA trial,<sup>122</sup> two CTZ trials,<sup>79,113</sup> five ETN trials,<sup>67,96,102,112,140</sup> three GOL trials,<sup>91,92,98</sup> two IFX trials<sup>118,125</sup> and five TCZ trials.<sup>57,103,115,116,121</sup> Across all interventions, where reported, mean DAS28 improved in all treatment arms, including control cDMARD arms. Biologic treatment arms reported higher percentages of patients meeting pre-defined DAS28 remission (usually < 2.6) than non-biologic control arms with one or two cDMARDs or baseline cDMARDs. There was a significantly higher percentage of patients meeting pre-defined DAS28 remission (usually < 2.6), or having significantly more improved DAS28 than baseline, than controls for ABT plus MTX than MTX plus PBO;<sup>62</sup> ADA monotherapy than PBO;<sup>122</sup> ETN (50 mg) once weekly plus MTX than MTX plus one other cDMARD;<sup>67,102</sup> ETN (50 mg) once weekly plus MTX than MTX plus SSZ plus HCQ at 24 weeks (in an analysis of treatment completers only, although not after 48 weeks with the option to switch therapy);<sup>112</sup> GOL plus MTX than MTX plus PBO at 6 months (not 1-year follow-up);<sup>91,92,98</sup> IFX plus MTX than MTX plus PBO;<sup>118,125</sup> TCZ plus MTX than TCZ monotherapy<sup>57</sup> or than MTX plus PBO;<sup>103</sup> TCZ monotherapy than cDMARDs,<sup>115</sup> although not compared with MTX plus PBO; and<sup>116</sup> TCZ plus DMARDs than DMARDs plus PBO.<sup>121</sup> ETN plus MTX performed significantly better than ETN monotherapy,<sup>140</sup> although not at 16 weeks' follow-up.<sup>59</sup>

(Academic-in-confidence information has been removed.)

### **Health Assessment Questionnaire Disability Index**

**Population 1** Ten trials reported HAQ-DI change from baseline (see *Appendix 4, Table 350*). These comprised a head-to-head trial,<sup>100</sup> six ADA trials,<sup>77,93,94,107–109</sup> two ETN trials<sup>81,87</sup> and one GOL trial.<sup>90</sup> There were improvements in HAQ-DI for most treatments, interventions and controls, although there tended to be more improvement for biologics than control arms, although not in all cases.<sup>87</sup>

**Populations 2 and 3** Four head-to-head trials<sup>58,66,74,85</sup> reported HAQ-DI change from baseline (see *Appendix 4, Table 351*). All trial arms improved HAQ-DI. ABT-treated patients achieved similar results to IFX<sup>74</sup> and ADA.<sup>66</sup> TCZ monotherapy produced slightly more improvement than ADA monotherapy (significance testing not reported).<sup>58</sup> In a small trial ( $n = 32$ ), ETN plus MTX produced slightly better HAQ-DI results than IFX plus MTX.<sup>85</sup>

Twenty-eight other trials reported HAQ-DI change from baseline for cDMARD-experienced patients (see *Appendix 4, Table 352*), comprising two ABT trials,<sup>62,73</sup> four ADA trials,<sup>69,80,84,122</sup> two CTZ trials,<sup>79,113</sup> 11 ETN trials,<sup>59,67,88,96,101,102,104,112,123,124,140,145</sup> two GOL trials,<sup>91,92</sup> four IFX trials<sup>75,86,118,126</sup> and two TCZ trials.<sup>57,121</sup> Generally, there was some improvement in HAQ-DI for all trial arms, with more improvement for biologics than control arms. (AiC information has been removed.)

### ***Joint counts and assessment of inflammation markers (C-reactive protein and erythrocyte sedimentation rate)***

**Population 1** The only head-to-head RCT in MTX-naïve patients identified in this review<sup>100</sup> did not report any follow-up or change data on joint counts or assessment of inflammation markers. A total of seven RCTs of biologic versus DMARD(s) or PBO reported follow-up or change data on joint counts or assessment of inflammation markers in MTX-naïve patients (three for ADA,<sup>94,107,108</sup> one for ETN,<sup>81</sup> one for GOL<sup>90</sup> and two for IFX<sup>110,120</sup>) (see *Appendix 4, Table 364*). Statistically significant differences in swollen joint count favouring biologic treatment over comparator were reported for ADA (one study<sup>94</sup>) and ETN (one study<sup>81</sup>). Statistically significant differences in tender joint count favouring biologic treatment over comparator were reported for ADA (two studies<sup>94,108</sup>) and GOL (one study<sup>90</sup>). Statistically significant differences in CRP response favouring biologic treatment over comparator were reported for ADA (one study<sup>108</sup>). Statistically significant differences in ESR response were not identified in any trials.

**Populations 2 and 3** Four head-to-head RCTs reporting data on joint counts and/or assessment of inflammation markers in cDMARD-experienced patients were identified (see *Appendix 4, Table 366*). Similar improvements were made in swollen joint count, tender joint count and CRP level among patients in the s.c. ABT plus MTX and ADA plus MTX arms of the abatacept vs. adalimumab in biologic-naïve RA patients with background MTX (AMPLE) trial.<sup>144</sup> Likewise, swollen joint count, tender joint count and CRP level were not significantly different between patients in the ADA plus cDMARDs and ETN plus cDMARDs arms of the RED-SEA trial.<sup>114</sup> The deFilippis trial<sup>85</sup> reported no difference in percentage change between arms for swollen joint count and CRP level but reported significantly greater improvements in tender joint count in the ETN plus MTX arm relative to the IFX versus MTX arm. Finally, similar reductions in swollen joint count and tender joint count were reported for patients in the TCZ plus PBO ADA and ADA plus PBO TCZ arms in the double-dummy ADACTA trial.<sup>58</sup>

Twenty RCTs of biologic versus DMARD(s) or PBO reported follow-up or change data on joint counts or assessment of inflammation markers in cDMARD-experienced patients (see *Appendix 4, Table 365*). Statistically significant differences in swollen joint count favouring biologic treatment over comparator were reported in eight trials [one ADA trial,<sup>80</sup> four ETN trials,<sup>89,101,104,105,124</sup> one GOL trial,<sup>92</sup> one TCZ trial<sup>121</sup> and (AiC information has been removed)]. Statistically significant differences in tender joint count favouring biologic treatment over comparator were reported in 11 trials [one ADA trial,<sup>80</sup> four ETN trials,<sup>101,102,104,105,124</sup> one GOL trial,<sup>92</sup> three IFX trials,<sup>75,86,125</sup> one TCZ trial<sup>121</sup> and (AiC information has been removed)]. Statistically significant differences in CRP response favouring biologic treatment over comparator were reported in six trials (one ADA trial,<sup>80</sup> four ETN trials<sup>89,101,104,105,124</sup> and one TCZ trial<sup>121</sup>). Statistically significant differences in ESR response favouring biologic treatment over comparator were reported in seven trials [five ETN trials,<sup>59,60,67,68,104,105,124</sup> one TCZ trial<sup>121</sup> and (AiC information has been removed)].

Two trials compared biologic monotherapy with biologic combination therapy. A trial of ETN reported significant improvements in swollen joint count, tender joint count and ERS for ETN combined with MTX but not ETN monotherapy and the reverse for CRP,<sup>140</sup> whereas a trial of TCZ plus oral PBO versus TCZ combined with MTX found no differences in joint counts or inflammation markers.<sup>57</sup>

One trial of biologic and cDMARD combination therapy (ETN + MTX) versus biologic monotherapy<sup>140</sup> reported significantly greater improvements in swollen joint count tender joint count and ESR in the combination therapy arm, but significantly greater improvements in CRP in the monotherapy arm.<sup>97</sup> Another trial of biologic and cDMARD combination therapy versus monotherapy (TCZ + MTX vs. TCZ + PBO)<sup>57</sup> reported similar changes from baseline in swollen joint count and tender joint count.

### *Patient and physician global assessments of disease activity*

**Population 1** No data were available for this outcome from the single identified head-to-head RCT in MTX-naïve patients.<sup>100</sup> Four population 1 trials in MTX-naïve patients contributed global assessment evidence (presented in *Appendix 4, Table 356*), of which two were for ADA,<sup>107,108</sup> one for GOL<sup>90</sup> and one for IFX.<sup>148</sup> Of these four trials, statistically significant improvements in global assessments of disease activity were reported for one trial favouring GOL plus MTX over PBO and MTX,<sup>90</sup> and for one trial<sup>148</sup> that favoured initial combination cDMARD therapy plus prednisone and initial combination cDMARD therapy plus IFX over sequential cDMARD monotherapy and step-up combination cDMARD therapy.

**Populations 2 and 3** Patient and physical global assessment of disease activity data were reported in three head-to-head RCTs of cDMARD-experienced patients<sup>66,85,114</sup> (see *Appendix 4, Table 357*). No statistically significant differences in treatment response were reported.

A total of 23 further RCTs evaluated global assessments of disease activity in four ADA trials,<sup>69,70,80,99,122</sup> four ETN trials,<sup>89,102,104,105,124</sup> one GOL trial<sup>92</sup> and three IFX trials<sup>75,86,125</sup> (see *Appendix 4, Table 358*).

### *Radiological progression/joint damage*

**Population 1** Data were extracted from RCTs where absolute baseline and follow-up, mean change from baseline or proportion change from baseline in joint outcomes were available.

No joint damage/radiological progression data were identified from the single identified head-to-head population 1 trial.<sup>100</sup> Six trials of biologic interventions versus DMARD(s) or PBO in MTX-naïve patients reported change in radiographic scores and/or radiographic non-progression (three ADA trials,<sup>93,108,109</sup> two ETN trials<sup>81,139</sup> and one IFX trial<sup>71</sup>). Joint outcomes were assessed using a range of radiographic scores,<sup>149</sup> and magnetic resonance imaging. Data for radiographic scores are presented in *Table 359* (see *Appendix 4*). Statistically significant results favouring intervention in the reduction of radiological progression were reported for two ADA trials,<sup>108,109</sup> one ETN trial<sup>139</sup> and one IFX trial.<sup>71</sup> Two trials (one each for ADA<sup>108,150</sup> and GOL<sup>151</sup>) provided joint assessment data as measured by magnetic resonance imaging (both of which reported statistically significant findings favouring biologic treatment; see *Appendix 4, Table 360*).

**Populations 2 and 3** One head-to-head trial<sup>66</sup> (ADA vs. ABT) (see *Appendix 4, Table 361*) and eight trials of biologic interventions versus DMARD(s) or PBO in cDMARD-experienced patients reported change in radiographic scores and/or rates of radiographic non-progression (one for ATB,<sup>61,62</sup> one for ADA,<sup>84</sup> two for ETN,<sup>102,111</sup> one for GOL,<sup>91</sup> two for IFX<sup>146,147</sup> and two for TCZ<sup>115,152</sup>) (see *Appendix 4, Table 362*). Statistically significant results indicating reduced radiological progression were reported for one ABT trial,<sup>61,62</sup> one ADA trial,<sup>84</sup> one ETN trial,<sup>102</sup> one GOL trial,<sup>91</sup> both IFX trials<sup>146,147</sup> and one TCZ trial.<sup>115</sup> Joint outcome data as assessed by magnetic resonance imaging were presented in three trials (one each for ABT,<sup>72</sup> GOL<sup>153</sup> and IFX<sup>120</sup>) (see *Appendix 4, Table 363*), with statistically significant benefits to joint outcomes reported for the GOL trial.<sup>153</sup>

Two trials compared biologic monotherapy with biologic combination therapy. A trial of ETN reported significant improvements in erosion score for ETN combined with MTX but not ETN monotherapy,<sup>140</sup> whereas a trial of TCZ plus oral PBO versus TCZ combined with MTX found no differences in radiographic progression.<sup>57</sup>

## Pain

**Population 1** Six trials reported pain visual analogue scale (VAS) score change from baseline (see *Appendix 4, Table 364*). These comprised three ADA trials,<sup>107–109</sup> one ETN trial,<sup>81</sup> one GOL trial<sup>90</sup> and one IFX trial.<sup>78</sup> There were reductions in pain VAS for most treatments and there were significant benefits for all four biologics compared with controls.

**Populations 2 and 3** Two head-to-head trials<sup>66,85</sup> reported pain VAS change from baseline (see *Appendix 4, Table 365*). All trial arms reduced pain VAS score. No significant differences were reported between groups.

Twenty-seven other trials reported pain VAS change from baseline for cDMARD-experienced patients (see *Appendix 4, Table 366*), comprising two ABT trials,<sup>62,73</sup> five ADA trials,<sup>69,80,84,99,122</sup> one CTZ trial,<sup>79</sup> nine ETN trials,<sup>59,67,88,101,102,104,112,124,140</sup> one GOL trial,<sup>92</sup> two IFX trials<sup>75,118</sup> and one TCZ trial.<sup>57</sup> Generally, there was some reduction in pain VAS for all trial arms. ABT had similar reductions compared with control groups.<sup>62,73</sup> There was at least one trial reporting significantly more pain VAS reduction than control for each of ADA, CTZ, ETN, GOL and IFX. In the Rheumatoid Arthritis Comparison of Active Therapies in Methotrexate Suboptimal Responders study (RACAT)<sup>112</sup> ETN (50 mg) once weekly plus MTX had similar results to MTX plus SSZ plus HCQ. In the ACT-RAY trial<sup>57</sup> TCZ monotherapy had similar results to TCZ plus MTX.

## Fatigue

**Population 1** The only head-to-head RCT in MTX-naive patients identified in this review<sup>100</sup> did not report any follow-up or change data on fatigue. A total of three RCTs of biologic versus DMARD(s) or PBO reported follow-up or change data on fatigue in MTX-naive patients (two for ADA<sup>154,155</sup> and one for ETN<sup>83</sup>) (see *Appendix 4, Tables 377 and 378*). Statistically significant differences favouring biologic treatment over comparator were reported for VAS score (one ETN trial<sup>83</sup>) and Functional Assessment of Chronic Illness Therapy – Fatigue (FACIT-F) score (one ADA trial<sup>154</sup>). One further ADA trial reported significant differences between ADA and MTX arms at follow-up in a mixed-model repeated measures analysis, but the values appear to be similar.<sup>155</sup>

**Populations 2 and 3** Two head-to-head RCTs reporting data on fatigue in cDMARD-experienced patients were identified (see *Appendix 4, Tables 369 and 370*).<sup>58,144</sup> Similar improvements were made on fatigue VAS score among patients in the s.c. ABT plus MTX and ADA plus MTX arms of the AMPLE trial<sup>144</sup> and on FACIT-F score among patients in the TCZ plus PBO ADA and ADA plus PBO TCZ arms in the ADOCTA trial.<sup>58</sup>

Six RCTs of biologic versus DMARD(s) or PBO reported follow-up or change data on fatigue data in cDMARD-experienced patients (see *Appendix 4, Tables 371 and 372*).<sup>63,68–70,79,92,121</sup> A statistically significant difference in VAS fatigue score swollen joint count favouring biologic treatment over comparator was reported in one ABT trial.<sup>63</sup> Statistically significant differences in FACIT-F score favouring biologic treatment over comparator were reported in four trials (one ADA trial,<sup>69,70</sup> one ETN trial,<sup>68</sup> one GOL trial<sup>92</sup> and one TCZ trial<sup>121</sup>). Mean (SD) change from baseline in the Fatigue Assessment Scale has been reported for the efficacy and safety of CERTolizumab pegol After INcomplete response to DMARDS in RA patients with low to moderate disease activity (CERTAIN) trial<sup>79</sup> of 0.1 (SD 2.12) in the PBO arm and –1.2 (SD 2.24) in the CTZ arm at week 24 (ClinicalTrials.gov, NCT00674362) and (AiC information has been removed).<sup>156</sup>

## Health-related quality of life

**Population 1** The only head-to-head RCT in MTX-naïve patients identified in this review<sup>100</sup> did not report any follow-up or change data on health-related quality of life. A total of nine RCTs of biologic versus DMARD(s) or PBO reported follow-up or change data on health-related quality of life in MTX-naïve patients (four for ADA,<sup>77,94,107,155</sup> two for ETN<sup>83,157</sup> and three for IFX<sup>71,72,110,158</sup>) (see *Appendix 4, Tables 383–388*). Statistically significant differences in Short Form questionnaire-36 items (SF-36) components and domains favouring biologic treatment over comparator were reported for ADA (one study<sup>154</sup>), ETN (two studies<sup>83,157</sup>) and IFX (one study<sup>78</sup>). One further ADA trial reported significant differences between ADA and MTX arms at follow-up in a mixed-model repeated measures analysis, but the values appear to be similar.<sup>155</sup> One study reported a statistically significant difference on the Short Form questionnaire-12 items physical component score for ADA.<sup>107</sup> Statistically significant differences in Rheumatoid Arthritis Quality of Life (RAQoL) score favouring biologic treatment over comparator were reported for ADA (one study<sup>77</sup>) and IFX (one study<sup>110</sup>). One further ADA trial reported significant differences on Short Form questionnaire-6 Dimensions (SF-6D) score between ADA and MTX arms at follow-up in a mixed-model repeated measures analysis, but the values appear similar.<sup>155</sup> One study reported a statistically significant difference on European Quality of Life-5 Dimensions (EQ-5D) score for ADA.<sup>107</sup>

**Populations 2 and 3** Three head-to-head RCTs reporting data on health-related quality of life in cDMARD-experienced patients were identified (see *Appendix 4, Tables 389–391*). Similar improvements were made on SF-36 components and domains scores among patients in the s.c. ABT plus MTX and ADA plus MTX arms of the AMPLE trial<sup>144</sup> and among patients in the ABT plus MTX, IFX plus MTX and MTX plus PBO arms of the ATTEST trial.<sup>74</sup> Significantly greater improvements were reported on SF-36 mental component score among patients in the TCZ (+ PBO ADA) arm than in the ADA (+ PBO TCZ) arm in the ADOCTA trial.<sup>58</sup> Similar improvements were made on EQ-5D score among patients in the ADA and ETN arms of the RED-SEA trial.<sup>114</sup>

Nine RCTs of biologic versus DMARD(s) or PBO reported follow-up or change data on health-related quality of life data in cDMARD-experienced patients (see *Appendix 4, Tables 392–397*). Statistically significant differences in SF-36 components and domains scores favouring biologic treatment over comparator were reported in six trials (one ABT trial,<sup>61,62</sup> one ETN trial,<sup>68</sup> one GOL trial,<sup>92</sup> two IFX trials<sup>86,159</sup> and one TCZ trial<sup>121</sup>). (AIC information has been removed.) Statistically significant differences in EQ-5D domain scores favouring biologic treatment over comparator were reported in one ETN trial<sup>59</sup> and a further ETN trial reported a statistically significant improvement in EuroQoL VAS score.<sup>89</sup>

### Extra-articular manifestations of disease

No included RCTs specifically evaluated the impact of biologic interventions on extra-articular manifestations of RA.

### Adverse effects of treatment

Data were extracted relating to discontinuations due to AEs, number of patients experiencing one or more AEs and number of patients experiencing one or more serious AE. Details are presented in *Appendix 4, Tables 398–400*. Specific AEs of important note as highlighted in the FDA prescribing information for each intervention were extracted from RCTs and associated LTEs of individual included RCTs and tabulated (see *Appendix 4, Tables 401–403*). These key safety issues identified across the range of interventions included the number of patients experiencing one or more infections, number of patients experiencing one or more serious infections (with pneumonia and reactivation of tuberculosis noted as important safety issues), number of patients experiencing one or more malignancy, and the occurrences of infusion-related or injection-site reactions (as appropriate to the mode of administration for each intervention).

## Mortality

Details of number of deaths, cause(s) of death and judgement by study team/adjudicator of whether or not death was potentially attributable to study drug were extracted and have been tabulated (see *Appendix 4, Tables 403 and 404*).

### **Additional evidence (trial data not eligible for full systematic review but included to inform network meta-analysis sensitivity analyses for populations 2 and 3)**

Study and population characteristics for the trials ineligible for the full systematic review but provided as additional evidence to inform sensitivity analyses are presented in *Table 344* (see *Appendix 4*). Two RCTs<sup>137,138</sup> in which TOF was evaluated were included as evidence to supplement the network.

The ACR and EULAR responses in populations 2 and 3 RCTs used in the sensitivity analyses are presented in *Tables 17 and 18* respectively.

## Network meta-analysis results

For ease of interpretation, a summary of the data used in the NMA is provided (*Tables 19–22*). As described earlier a number of sensitivity analyses were undertaken to allow the impact of further information, albeit subject to potential biases, including a small proportion of patients with prior bDMARD use, and including studies in which the patients (for populations 2 and 3) have low background MTX use and may not be truly MTX failures. The RCTs have been grouped into those that fit within the Assessment Group base case and those that have prior bDMARD use and/or low background MTX use.

*Tables 21 and 22* provide data for population 1 using EULAR and ACR criteria respectively. Only one RCT that reported EULAR data met the criteria for inclusion.

Additionally, the trials with EULAR data have been further subdivided into whether data were reported for all three categories or whether these were aggregated differently, for example only values for response or no response was provided. Data from the tumour necrosis factor inhibitors against combination intensive therapy (TACIT) study<sup>141</sup> were provided as AiC.

*Tables 19 and 20* provide data for populations 2 and 3 using EULAR and ACR criteria respectively.

In all tables the data have been apportioned so that these are mutually exclusive (i.e. that ACR20 now refers to patients who made an ACR20 response but not an ACR50 response). Typically, the RCTs would include patients with an ACR50 or ACR70 response within the ACR20 category, with the sum of the ACR responses being larger than the total number within the trial arm.

### **Population 1 (methotrexate naive)**

#### **American College of Rheumatology: main trials**

A NMA was used to compare the effects of ADA (with and without MTX), ETN (with and without MTX), IFX plus MTX, GOL plus MTX, intensive cDMARDs and step-up intensive cDMARDs relative to cDMARDs on ACR response.

Data were available from eight studies comparing two, three or four interventions.<sup>78,81,86,87,90,94,108,109</sup>

*Figure 4* presents the network of evidence and *Table 23* presents the frequency with which each pair of treatments was compared. There are eight treatment effects to estimate from eight studies.<sup>78,81,86,87,90,94,108,109</sup>

TABLE 17 American College of Rheumatology response: populations 2 and 3 – RCTs used in the sensitivity analyses of the NMA

Trial name/study	Treatment arms for which data extraction performed	Assessment time point	Numbers analysed	% achieving ACR20 response	% achieving ACR50 response	% achieving ACR70 response	Data used in NMA?
ACQUIRE <sup>127</sup>	ABT s.c. + PBO + MTX	26 weeks	736	74.8	50.2	25.8	Yes (SAs)
	ABT i.v. + PBO + MTX	26 weeks	721	74.3	48.6	24.2	
NCT00254293 <sup>131</sup>	PBO + MTX	25.7 weeks	119	35.3	11.8	1.7	Yes (SAs)
	ABT i.v. + MTX	25.7 weeks	115	60 <sup>a</sup>	36.5 <sup>a</sup>	16.5 <sup>a</sup>	
ORAL STANDARD <sup>133</sup>	PBO + MTX	26 weeks	106	28.3	12	2	Yes (SAs)
	TOF5 + MTX	26 weeks	196	51.5	36	20	
	TOF10 + MTX	26 weeks	196	52.6	33	22.5	
	ADA + MTX	26 weeks	199	47.2	27	9.5	
Yamamoto <i>et al.</i> , 2011 <sup>129</sup>	PBO + MTX	24 weeks	77	24.7	16.9	1.3	Yes (SAs)
	CTZ + MTX	24 weeks	82	73.2 <sup>b</sup>	54.9 <sup>b</sup>	29.3 <sup>b</sup>	
RA0025 <sup>134</sup>	PBO + MTX	24 weeks	40	27.5	20	2.5	Yes (SAs)
	CTZ + MTX	24 weeks	81	66.7 <sup>b</sup>	43.2 <sup>a</sup>	17.3 <sup>a</sup>	
RAPID1 <sup>135</sup>	PBO + MTX	24 weeks	199	13.6	7.6	3	Yes (SAs)
	CTZ + MTX	24 weeks	393	58.8 <sup>b</sup>	37.1 <sup>b</sup>	21.4 <sup>b</sup>	
RAPID2 <sup>136</sup>	PBO + MTX	24 weeks	127	8.7	3.1	0.8	Yes (SAs)
	CTZ + MTX	24 weeks	246	57.3 <sup>b</sup>	32.5 <sup>b</sup>	15.9 <sup>a</sup> (comparison of ORs from logistic regressions)	
TEAR <sup>53</sup>	MTX monotherapy	24 weeks	379	39.39	19	3.43	Yes (SAs)
	MTX + SSZ + HCQ	24 weeks	132	55.32	31.14	8.52	
	ETN50 + MTX	24 weeks	244	55.7	32.3	12.04	

continued

TABLE 17 American College of Rheumatology response: populations 2 and 3 – RCTs used in the sensitivity analyses of the NMA (continued)

Trial name/study	Treatment arms for which data extraction performed	Assessment time point	Numbers analysed	% achieving ACR20 response	% achieving ACR50 response	% achieving ACR70 response	Data used in NMA?
TEMPO <sup>54</sup>	MTX monotherapy	24 weeks	228	74.18	41.31	15.9	Yes (SAs)
	ETN monotherapy	24 weeks	223	71.58	41.31	17.98	
	ETN + MTX	24 weeks	231	82.53	60.09	36.65	
LITHE <sup>152</sup>	PBO + MTX	24 weeks	393	27	10	2	Yes (SAs)
	TCZ + MTX	24 weeks	398	56 <sup>b</sup>	32 <sup>b</sup>	13 <sup>b</sup>	
OPTION <sup>132</sup>	PBO + MTX	24 weeks	204	26	11	2	Yes (SAs)
	TCZ + MTX	24 weeks	205	59 <sup>b</sup>	44 <sup>b</sup>	22 <sup>b</sup>	
AMBITION <sup>128</sup>	MTX (MTX-experienced subgroup)	24 weeks	88	47.7	30.7	15.9	Yes (SAs)
	TCZ (MTX-experienced subgroup)	24 weeks	89	71.9 <sup>a</sup>	40.4	28.1	
van der Heijde <i>et al.</i> , 2013 <sup>138</sup>	PBO + MTX	26 weeks	160	25.3	8.4	1.3	Yes (SAs)
	TOF5 + MTX	26 weeks	321	51.5 <sup>b</sup> (added vs. PBO+MTX)	32.4 <sup>b</sup> (added vs. PBO+MTX)	14.6 <sup>b</sup> (added vs. PBO+MTX)	
	TOF10 + MTX	26 weeks	316	61.8 <sup>b</sup> (added vs. PBO+MTX)	43.7 <sup>b</sup> (added vs. PBO+MTX)	22.3 <sup>b</sup> (added vs. PBO+MTX)	
Kremer <i>et al.</i> , 2012 <sup>137</sup>	PBO + MTX	24 weeks	69	24.62	23.08	19.87	Yes (SAs)
	TOF5 + MTX	24 weeks	71	47.44	33.33	19.23 <sup>a</sup> (added vs. PBO+MTX)	
	TOF10 + MTX	24 weeks	74	54.49 <sup>a</sup> (added vs. PBO+MTX)	34.62	16.67 <sup>a</sup> (added vs. PBO+MTX)	

ACQUIRE, subcutaneous abatacept versus intravenous abatacept; ETN50, etanercept 50 mg once a week subcutaneously; LITHE, tocilizumab safety and the prevention of structural joint damage methotrexate and sulfasalazine combination trial; NCT00254293, Study to Assess Steady-State Trough Concentrations, Safety, and Immunogenicity of Abatacept After Subcutaneous (SC) Administration to Subjects With Rheumatoid Arthritis (RA); OPTION, tocilizumab Pivotal Trial in methotrexate inadequate responders; OR, odds ratio; ORAL, Tofacitinib or Adalimumab versus Placebo in Rheumatoid Arthritis; RAPID, Rheumatoid Arthritis Prevention of structural Damage; SA, sensitivity analysis; TOF5, tofacitinib 5 mg; TOF10, tofacitinib 10 mg.

a  $p < 0.05$ .

b  $p < 0.001$ .

Data are shown to the level of accuracy available in the source material.



TABLE 18 European League Against Rheumatism response: populations 2 and 3 – RCTs used in the sensitivity analyses of the NMA

Trial name/study	Treatment arms for which data extraction performed	Assessment time point	Numbers analysed	% achieving EULAR response	% achieving moderate EULAR response	% achieving good EULAR response	% EULAR responder (moderate/good)	In NMA?
JRAPID <sup>129</sup>	PBO + MTX	24 weeks	77	70.1	NR	NR	29.9	Yes (SAs)
Yamamoto <i>et al.</i> , 2011 <sup>129</sup>	CTZ + MTX	24 weeks	82	14.6	NR	NR	85.4	Yes (SAs)
RAPID1 <sup>135</sup>	PBO + MTX	24 weeks	199	72.9	NR	NR	(AIC information has been removed)	Yes (SAs)
RAPID1 <sup>135</sup>	CTZ + MTX	24 weeks	393	19.1	NR	NR	(AIC information has been removed)	Yes (SAs)
(AIC information has been removed)								
OPTION <sup>132</sup>	PBO + MTX	24 weeks	205	64.9	32.2	2.9	28.8	Yes (SAs)
	TCZ + MTX	24 weeks	204	20.6	41.2 <sup>a</sup>	38.2 <sup>b</sup>	79.4	Yes (SAs)

NR, not reported; OPTION, tocilizumab Pivotal Trial In methotrexate inadequate responders; RAPID, Rheumatoid Arthritis Prevention of structural Damage; SA, sensitivity analysis.  
<sup>a</sup>  $p < 0.001$ .

**TABLE 19** The EULAR data used in the NMA for populations 2 and 3

Trial name/ study	Intervention			Mean disease duration (weeks)	Intervention 1 (patients, <i>n</i> )			
	1	2	3		No response	Moderate EULAR	Good EULAR	Total population
<b>Base case: full data reported</b>								
ACT-RAY <sup>57</sup>	TCZ + MTX	TCZ		676	29	77	171	277
ADACTA <sup>58</sup>	ADA	TCZ		354	73	57	32	162
ATTEST <sup>74</sup>	cDMARD	ABT i.v. + MTX	IFX + MTX	405	46	45	11	102
CERTAIN <sup>79</sup>	cDMARD	CTZ + MTX		239	42	16	11	69
GO-FORTH <sup>91</sup>	cDMARD	GOL + MTX		455	43	30	11	84
JESMR <sup>140</sup>	ETN + MTX	ETN		485	3	32	38	73
LARA <sup>102</sup>	Intensive cDMARD	ETN + MTX		430	50	75	17	142
SATORI <sup>116</sup>	cDMARD	TCZ		447	39	23	2	64
TACIT <sup>141</sup>	Intensive cDMARD	Grouped biologics <sup>a</sup> + MTX		AiC information has been removed	AiC information has been removed	AiC information has been removed	AiC information has been removed	AiC information has been removed
Van De Putte <i>et al.</i> , 2004 <sup>122</sup>	ADA	PBO		577	50	53	10	113
<b>Base case: no response and response (i.e. moderate and good combined) reported</b>								
AUGUST II <sup>76</sup>	cDMARD	ADA + MTX		447	31			76
GO-FORWARD <sup>92</sup>	cDMARD	GOL + MTX		421	77			133
START <sup>118</sup>	cDMARD	IFX + MTX			186			332
TOWARD <sup>121</sup>	cDMARD	TCZ + MTX		510	258			413
<b>Base case: good and not good (i.e. moderate and no response combined) reported</b>								
Swefot <sup>119</sup>	Intensive cDMARD	IFX + MTX		27			31	130
<b>Sensitivity analyses: prior bDMARD use for some patients – full data reported</b>								
OPTION <sup>132</sup>	cDMARD	TCZ + MTX		398	133	66	6	205
<b>Sensitivity analyses: prior biologics – no response and response (i.e. moderate and good combined) reported</b>								
RAPID1 <sup>135</sup>	cDMARD	CTZ + MTX		319	145	54		199
Yamamoto <i>et al.</i> , 2011 <sup>129</sup>	cDMARD	CTZ + MTX		296	54	23		77
GO-FORTH, golimumab in combination with methotrexate in Japanese patients with active rheumatoid arthritis; OPTION, tOcilimumab Pivotal Trial In methotrexate inadequate respONders; RAPID, Rheumatoid Arthritis Prevention of structural Damage; SATORI, Study of Active controlled TOcilizumab for Rheumatoid arthritis patients with an Inadequate response to methotrexate; START, Safety Trial for rheumatoid Arthritis with Remicade Therapy. a A clinician's choice of ADA or ETN or IFX all with MTX.								

Intervention 2 (patients, <i>n</i> )				Intervention 3 (patients, <i>n</i> )			
No response	Moderate EULAR	Good EULAR	Total population	No response	Moderate EULAR	Good EULAR	Total population
38	96	142	276				
36	43	84	163				
35	85	30	150	53	67	36	156
18	32	29	79				
13	30	38	81				
20	26	23	69				
23	125	131	279				
2	19	40	61				
AiC information has been removed	AiC information has been removed	AiC information has been removed	AiC information has been removed				
81	25	4	110				
15			79				
25			89				
83			333				
163			803				
		43	128				
42	84	78	204				
75	318		393				
12	70		82				

TABLE 20 The ACR data used in the NMA for populations 2 and 3

Trial name/ study	Intervention				Mean disease duration (weeks)	Intervention 1 (patients, n)				Intervention 2 (patients, n)					
	1	2	3	4		No response	ACR20 response	ACR50 response	ACR70 response	Total population	No response	ACR20 response	ACR50 response	ACR70 response	Total population
	Base case: full data reported														
CREATE II <sup>36</sup>	cDMARD	ETN+MTX			419	44	10	8	3	65	22	12	15	15	64
ACT-RAY <sup>57</sup>	TCZ+MTX	TCZ			676	79	72	58	68	277	82	83	41	70	276
ADACTA <sup>58</sup>	ADA	TCZ			354	82	35	16	29	162	57	29	24	53	163
AIM <sup>61</sup>	cDMARD	ABT i.v.+MTX			449	132	50	23	14	219	139	121	87	86	433
AMPLE <sup>144</sup>	ADA+MTX	ABT s.c.+MTX			94	117	72	65	74	328	108	65	68	77	318
ARMADA <sup>69</sup>	cDMARD	ADA+MTX			607	53	4	2	3	62	22	8	19	18	67
ATTEST <sup>74</sup>	cDMARD	ABT i.v.+MTX	IFX+MTX		405	64	24	12	10	110	52	41	31	32	156
ATTRACT <sup>75</sup>	cDMARD	IFX+MTX			NR	67	13	4	0	84	42	19	16	7	83
AUGUST II <sup>76</sup>	cDMARD	ADA+MTX			447	40	24	8	4	76	23	26	16	14	79
CERTAIN <sup>79</sup>	cDMARD	CTZ+MTX			239	83	8	4	3	98	61	15	11	9	96
CHANGE <sup>80</sup>	ADA	PBO			477	51	18	11	11	91	75	7	4	1	87
deFilippis et al., 2006 <sup>85</sup>	ETN+MTX	IFX+MTX				7	5	3	1	16	7	4	4	1	16
DE019 <sup>80</sup>	cDMARD	ADA+MTX			569	141	40	14	5	200	76	50	38	43	207
ETN study 309 <sup>89</sup>	cDMARD	ETN+MTX	ETN		341	36	7	6	1	50	27	22	27	25	101
GO-FORTH <sup>91</sup>	cDMARD	GOL+MTX			455	59	16	8	5	88	25	25	13	23	86
GO-FORWARD <sup>92</sup>	cDMARD	GOL+MTX			421	96	19	11	7	133	36	20	15	18	89
JESMR <sup>140</sup>	ETN+MTX	ETN			485	7	19	19	28	73	25	11	15	18	69
Kim et al., 2007 <sup>99</sup>	cDMARD	ADA+MTX			356	40	14	4	5	63	25	12	14	14	65
LARA <sup>102</sup>	Intensive cDMARD	ETN+MTX			430	71	38	17	16	142	47	59	76	97	279
Mathias et al., 2000 <sup>105</sup>	ETN	PBO			598	31	15	20	12	78	71	5	3	1	80
O'Dell 2013 <sup>112</sup>	Intensive cDMARD	ETN+MTX			271	70	48	33	8	159	73	32	32	26	163
SAMURAJ <sup>115</sup>	cDMARD	TCZ			119	89	30	16	10	145	28	39	37	53	157
SATORI <sup>116</sup>	cDMARD	TCZ			447	48	5	4	7	64	12	16	13	20	61
STAR <sup>117</sup>	cDMARD	ADA+MTX			541	207	75	25	11	318	150	76	45	47	318
START <sup>118</sup>	cDMARD	IFX			NR	271	57	18	17	363	152	93	65	50	360

Trial name/ study	Intervention				Mean disease duration (weeks)	Intervention 1 (patients, n)				Intervention 2 (patients, n)					
	1	2	3	4		No response	ACR20 response	ACR50 response	ACR70 response	Total population	No response	ACR20 response	ACR50 response	ACR70 response	Total population
TOWARD <sup>121</sup>	cDMARD	TCZ			510	312	64	25	12	413	315	186	137	165	803
Van De Putte <i>et al.</i> , 2004 <sup>122</sup>	ADA	PBO			577	61	27	11	14	113	89	12	7	2	110
Weinblatt <i>et al.</i> , 1999 <sup>124</sup>	cDMARD	ETN + MTX			676	22	7	1	0	30	17	19	14	9	59
<b>Sensitivity analyses: prior bDMARD use for some patients – full data reported</b>															
ACQUIRE <sup>127</sup>	ABT i.v. + MTX	ABT s.c. + MTX			398	186	185	176	174	721	185	181	180	190	736
Kremer <i>et al.</i> , 2010 <sup>65</sup>	cDMARD	TOF5 + MTX	TOF10 + MTX		444	52	1	2	14	69	37	10	10	14	71
LITHE <sup>130</sup>	cDMARD	TCZ + MTX			476	287	67	31	8	393	174	96	76	52	398
<sup>131</sup>	cDMARD	ABT i.v. + MTX			483	77	28	12	2	119	46	27	23	19	115
OPTION <sup>132</sup>	cDMARD	TCZ + MTX			398	151	31	18	4	204	84	31	45	45	205
RA0025 <sup>134</sup>	cDMARD	CTZ + MTX			303	29	3	7	1	40	27	19	21	14	81
RAPID1 <sup>135</sup>	cDMARD	CTZ + MTX			319	171	12	9	6	199	162	85	62	84	393
RAPID2 <sup>136</sup>	cDMARD	CTZ + MTX			308	116	7	3	1	127	105	61	41	39	246
van der Heijde <i>et al.</i> , 2013 <sup>138</sup>	cDMARD	TOF5 + MTX	TOF10 + MTX		467	120	27	11	2	160	156	61	57	47	321
Yamamoto <i>et al.</i> , 2011 <sup>129</sup>	cDMARD	CTZ + MTX			296	58	6	12	1	77	22	15	21	24	82
<b>Sensitivity analyses: prior biologics – no ACR50 or ACR70 reported</b>															
ORAL STANDARD <sup>133</sup>	cDMARD	ADA + MTX	TOF5 + MTX	TOF10 + MTX	402	76	30			106	105	94	N/A	N/A	199
<b>Sensitivity analyses: prior biologics – full data reported and low background MTX use</b>															
AMBITION <sup>65</sup>	cDMARD	TCZ			330	46	15	13	14	88	25	28	11	25	89
<b>Sensitivity analyses: low background MTX use</b>															
TEAR <sup>53</sup>	cDMARD	Intensive cDMARD	ETN + MTX		18	230	77	59	13	379	59	32	30	11	132
TEMPO <sup>54</sup>	cDMARD	ETN + MTX	ETN		345	59	75	58	36	228	40	52	54	85	231

TABLE 20 The ACR data used in the NMA for populations 2 and 3 (continued)

Trial name	Intervention 3 (patients, n)				Intervention 4 (patients, n)					
	No response	ACR20 response	ACR50 response	ACR70 response	Total population	No response	ACR20 response	ACR50 response	ACR70 response	Total population
<b>Base case: full data reported</b>										
ATTEST <sup>74</sup>	67	37	21	40	165					
ETN study 309 <sup>89</sup>	27	28	26	22	103					
<b>Sensitivity analyses: prior bDMARD use for some patients – full data reported</b>										
Kremer et al., 2010 <sup>63</sup>	34	15	13	12	74					
van der Heijde et al., 2013 <sup>38</sup>	121	57	68	70	316					
<b>Sensitivity analyses: prior biologics – no ACR50 or ACR70 reported</b>										
ORAL STANDARD <sup>33</sup>	95	101	N/A	N/A	196	93	103	N/A	N/A	196
<b>Sensitivity analyses: low background MTX use</b>										
TEAR <sup>53</sup>	109	57	49	29	244					
TEMPO <sup>54</sup>	63	68	52	40	223					

ACQUIRE, subcutaneous abatacept versus intravenous abatacept; AIM, Abatacept in Inadequate responders to Methotrexate; ARMADA, Anti-TNF factor Research study program of the Monoclonal antibody Adalimumab (D2E7) in rheumatoid arthritis; ATTRACT, Anti-TNF trial in Rheumatoid Arthritis with Concomitant Therapy; CHANGE, Clinical investigation in Highly disease-affected rheumatoid arthritis patients in Japan with Adalimumab applying standard and General Evaluation study; DE019, Efficacy and Safety of Adalimumab in Patients With Active Rheumatoid Arthritis Treated Concomitantly With Methotrexate; GO-FORTH, golimumab in combination with methotrexate in Japanese patients with active rheumatoid arthritis; LITHE, tocilizumab safety and the prevention of structural joint damage methotrexate and sulfasalazine combination trial; N/A, not applicable; NCT00254293, Study to Assess Steady-State Trough Concentrations, Safety, and Immunogenicity of Abatacept After Subcutaneous (SC) Administration to Subjects With Rheumatoid Arthritis (RA); NR, not reported; OPTION, tocilizumab Pivotal Trial in methotrexate inadequate responders; ORAL, Tofacitinib or Adalimumab versus Placebo in Rheumatoid Arthritis; RAPID, Rheumatoid Arthritis Prevention of structural Damage; SAMURAI, Study of Active controlled Monotherapy Used for Rheumatoid Arthritis, an IL-6 Inhibitor; SATORI, Study of Active controlled Tocilizumab for Rheumatoid arthritis patients with an inadequate response to methotrexate; STAR, Safety Trial of Adalimumab in Rheumatoid arthritis; START, Safety Trial for rheumatoid arthritis with Remicade Therapy; TOF5, tofacitinib 5 mg; TOF10, tofacitinib 10 mg.

TABLE 21 The EULAR data for population 1

Trial name	Intervention		Mean disease duration (weeks)	Intervention 1 (patients, n)			Intervention 2 (patients, n)			
	1	2		No response	Moderate EULAR	Good EULAR	Total population	No response	Moderate EULAR	Good EULAR
GO-BEFORE <sup>90</sup>	cDMARD	GOL+MTX	166	62	160	160	43	159		

**Base case: no response and response (i.e. moderate and good combined) reported**

TABLE 22 The ACR data used in the NMA for population 1

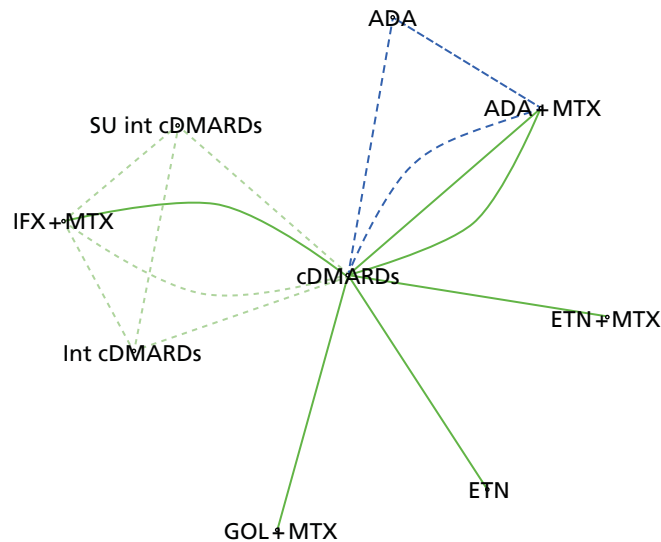
Trial name/study	Intervention				Mean disease duration (weeks)	Intervention 1 (patients, n)				Intervention 2 (patients, n)					
	1	2	3	4		No response	ACR20 response	ACR50 response	ACR70 response	Total population	No response	ACR20 response	ACR50 response	ACR70 response	Total population
<b>Base case: full data reported</b>															
COMET <sup>81</sup>	cDMARD	ETN+ MTX				109	57	55	47	268	50	57	64	103	274
Durez et al., 2007 <sup>120</sup>	cDMARD	IFX+ MTX			21	10	3	1	0	14	2	3	5	5	15
ERA <sup>39</sup>	cDMARD	ETN			52	90	58	38	31	217	65	55	42	45	207
GO-BEFORE <sup>90</sup>	cDMARD	GOL+ MTX			166	81	32	22	25	160	61	34	26	38	159
HIT HARD <sup>34</sup>	cDMARD	ADA+ MTX			7	27	16	19	23	85	20	13	13	41	87
OPTIMA <sup>108</sup>	cDMARD	ADA+ MTX			18	222	119	88	88	517	153	93	88	181	515
PREMIER <sup>109</sup>	cDMARD	ADA+ MTX	ADA		38	99	54	47	57	257	84	27	43	114	268
<b>Base case: data reported only for ACR20 and ACR70</b>															
BeST <sup>78</sup>	cDMARD	IFX+ MTX	Intensive cDMARD	Step-up intensive cDMARD <sup>a</sup>	NR	63	43		20	126	33	55		40	128
<b>Sensitivity analyses: low background MTX use</b>															
TEAR <sup>53</sup>	cDMARD	Intensive cDMARD	ETN+ MTX		18	230	77	59	13	379	59	32	30	11	132
TEMPO <sup>54</sup>	cDMARD	ETN+ MTX	ETN		345	59	75	58	36	228	40	52	54	85	231



Trial name	Intervention	Intervention 3 (patients, n)				Intervention 4 (patients, n)						
		No response	ACR20 response	ACR50 response	ACR70 response	Total population	No response	ACR20 response	ACR50 response	ACR70 response	Total population	
	3											
	4											
<b>Base case: full data reported</b>												
PREMIER <sup>109</sup>	ADA	128	50	42	54	274						
<b>Base case: data reported only for ACR20 and ACR70</b>												
BeST <sup>78</sup>	Intensive cDMARD	39	59		35	133	48	59	14	121		
	Step-up intensive cDMARD <sup>a</sup>											
<b>Sensitivity analyses: low background MTX use</b>												
TEAR <sup>53</sup>	ETN + MTX	109	57	49	29	244						
TEMPO <sup>54</sup>	ETN	63	68	52	40	223						

BeST, BEHandelings Strategie; ERA, Early Rheumatoid Arthritis (etanercept); COMET, Combination Of METHotrexate and etanercept in early rheumatoid arthritis; HIT HARD, High Induction Therapy with Anti-Rheumatic Drugs (adalimumab and methotrexate); NR, not reported; OPTIMA, OPTimal protocol for treatment Initiation with Methotrexate and Adalimumab; PREMIER, Patients REceiving Methotrexate and Infliximab for the treatment of Early Rheumatoid arthritis.

a Intensive cDMARD with escalation of doses as required.



**FIGURE 4** American College of Rheumatology (population 1: main trials) – network of evidence. Int, intensive; SU, step-up. Solid green line (two-arm study); dotted blue line (three-arm study); and dotted green line (four-arm study).

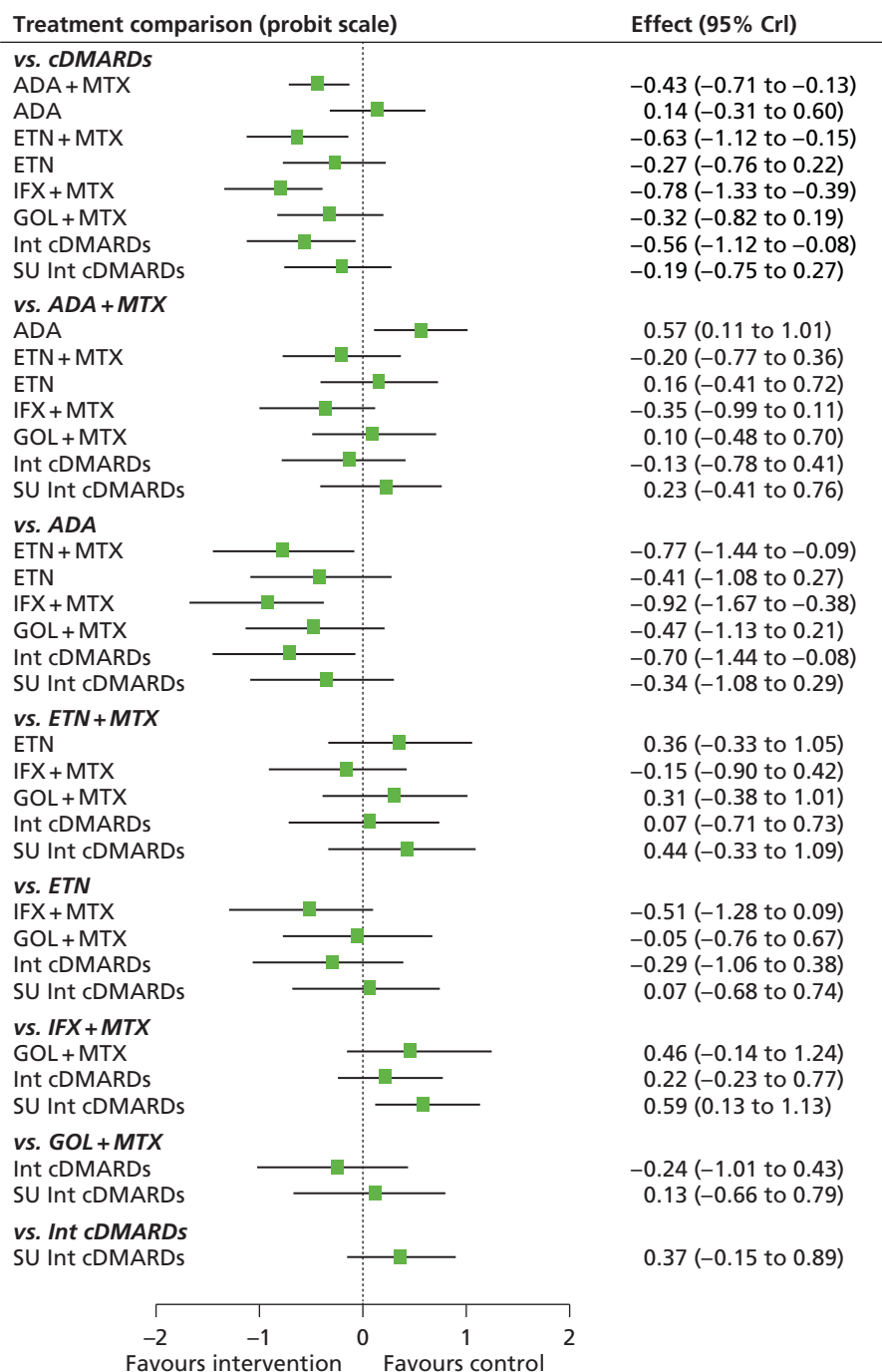
**TABLE 23** American College of Rheumatology (population 1: main trials) – the number of RCTs in which each pair of interventions were compared

Intervention	cDMARDs	ADA + MTX	ADA	ETN + MTX	ETN	IFX + MTX	GOL + MTX	Intensive cDMARDs	Step-up intensive cDMARDs
cDMARDs	–	3	1	1	1	2	1	1	1
ADA + MTX	–	–	1	0	0	0	0	0	0
ADA	–	–	–	0	0	0	0	0	0
ETN + MTX	–	–	–	–	0	0	0	0	0
ETN	–	–	–	–	–	0	0	0	0
IFX + MTX	–	–	–	–	–	–	0	1	1
GOL + MTX	–	–	–	–	–	–	–	0	0
Intensive cDMARDs	–	–	–	–	–	–	–	–	1
Step-up intensive cDMARDs	–	–	–	–	–	–	–	–	–

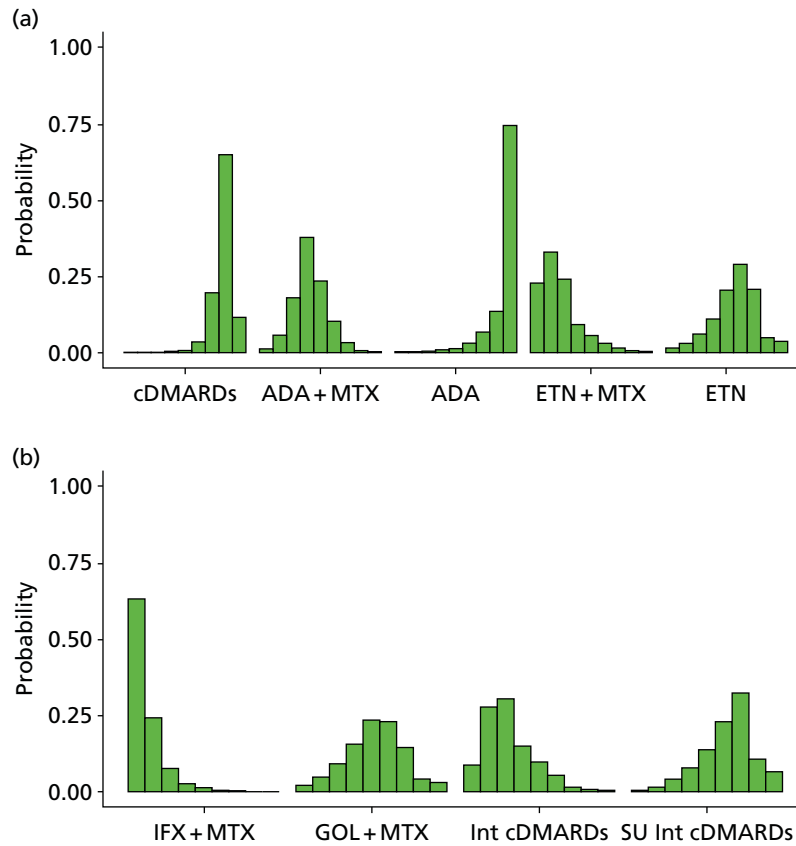
The probit transformation provides a transformation of data that can only take values between zero and 1 to values that cover the whole real line (i.e. to values between  $\pm \infty$ ). It is used to transform parameters that represent probabilities to a transformed parameter on the real line; treatment effects estimated on the real line usually have better statistical properties than estimates on a restricted scale. The transformation makes use of the standard normal distribution, which has mean zero and variance 1. Parameters representing probabilities can be thought of as being the area under the standard normal distribution from  $-\infty$  to some value that represents the transformed value on the probit scale. In the case of EULAR and ACR, parameters represent the probabilities of being in one of several ordered categories. The statistical model includes parameters representing the baseline response (i.e. 'no response') for the control arm in each study; a cut-off representing the distance on the standard normal scale between the category boundaries; treatment effect representing the number of SDs on the standard normal scale. Large negative treatment effects represent positive treatment effects (i.e. a smaller proportion of patients in the lower categories).

Figure 5 presents the effects of each intervention relative to cDMARDs on the probit scale, and Figure 6 and Table 24 present the probabilities of treatment rankings. Treatment rankings should be interpreted as in the following example: for cDMARDs there is a 19.6% probability that it is the seventh most efficacious treatment, a 64.8% probability that it is the eighth most efficacious treatment and an 11.5% probability that it is the least effective (i.e. ninth) treatment.

The model fitted the data reasonably well, with the total residual deviance, 64.87, close to the total number of data points, 53, included in the analysis. The largest residual deviances were 5.82 from Durez *et al.*<sup>86</sup> and 4.21 from the BEhandelingen STRategie (BeST) study.<sup>78</sup>



**FIGURE 5** American College of Rheumatology (population 1: main trials) – effects of interventions relative to cDMARDs on the probit scale. CrI, credible interval; Int, intensive; SU, step-up.



**FIGURE 6** American College of Rheumatology (population 1: main trials) – probability of treatment rankings in terms of efficacy (most efficacious = 1). Int, intensive; SU, step-up.

**TABLE 24** American College of Rheumatology (population 1: main trials) – probability of treatment rankings in terms of efficacy (most efficacious = 1)

Intervention	Rank (mean)	Rank								
		1	2	3	4	5	6	7	8	9
cDMARDs	7.8	0.000	0.000	0.000	0.001	0.006	0.034	0.196	0.648	0.115
ADA + MTX	4.2	0.013	0.057	0.180	0.378	0.234	0.101	0.031	0.005	0.001
ADA	8.5	0.001	0.001	0.004	0.007	0.013	0.029	0.066	0.135	0.744
ETN + MTX	2.6	0.228	0.329	0.242	0.091	0.056	0.030	0.014	0.006	0.004
ETN	5.6	0.013	0.030	0.060	0.110	0.204	0.289	0.206	0.050	0.037
IFX + MTX	1.6	0.633	0.243	0.077	0.027	0.014	0.004	0.001	0.000	0.000
GOL + MTX	5.2	0.021	0.048	0.093	0.156	0.235	0.229	0.145	0.042	0.030
Intensive cDMARDs	3.2	0.086	0.278	0.305	0.151	0.099	0.054	0.016	0.007	0.003
Step-up intensive cDMARDs	6.2	0.004	0.015	0.039	0.079	0.138	0.230	0.324	0.106	0.065

The between-study SD was estimated to be 0.13 [95% credible interval (CrI) 0.01 to 0.52], which implies mild to moderate heterogeneity between studies in intervention effects.

All interventions except for ADA were associated with beneficial treatment effects relative to cDMARDs with the greatest effect being associated with IFX plus MTX. However, the treatment effects were statistically significant only for ADA plus MTX, ETN plus MTX, IFX plus MTX and intensive cDMARDs at a conventional 5% level. IFX plus MTX (mean rank 1.6; probability of being the best 0.633) was the treatment that was most likely to be the most effective intervention.

A meta-analysis was used to estimate the proportion of patients experiencing an ACR 'no response' when treated with cDMARDs.

Data were available from eight studies.<sup>78,81,86,87,90,94,108,109</sup>

The model fitted the data reasonably well, with the total residual deviance, 11.74, close to the total number of data points, 8, included in the analysis. The largest residual deviance was 3.35 from Durez *et al.*<sup>86</sup>

The between-study SD was estimated to be 0.14 (95% CrI 0.01 to 0.44), which implies mild heterogeneity between studies in the baseline response.

Table 25 presents the probabilities of achieving at least an ARC20 response, an ACR50 response and an ACR70 response. These are derived by combining the treatment effects estimated from the NMA with the estimate of the cDMARDs 'no response' rate.

### American College of Rheumatology: main trials plus methotrexate experienced

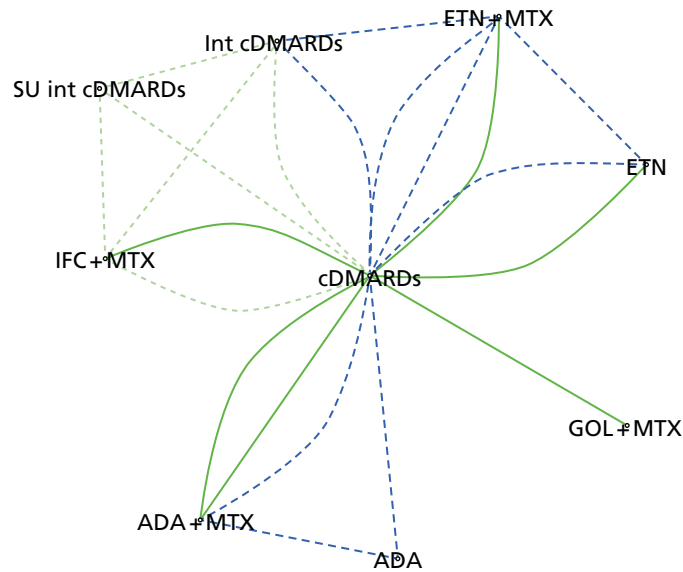
A NMA was used to compare the effects of ADA (with and without MTX), ETN (with and without MTX), IFX plus MTX, GOL plus MTX, intensive cDMARDs and step-up intensive cDMARDs relative to cDMARDs on ACR response.

Data were available from 10 studies comparing two, three or four interventions.<sup>53,54,78,81,90,94,109,120,139,142</sup>

Figure 7 presents the network of evidence and Table 26 presents the frequency with which each pair of treatments was compared. There are eight treatment effects to estimate from 10 studies.

**TABLE 25** American College of Rheumatology (population 1: main trials) – probabilities of achieving ACR responses

Intervention	At least ACR20 (95% CrI)	At least ACR50 (95% CrI)	At least ACR70 (95% CrI)
cDMARDs	0.564 (0.495 to 0.632)	0.322 (0.245 to 0.411)	0.169 (0.116 to 0.237)
ADA + MTX	0.722 (0.600 to 0.820)	0.486 (0.345 to 0.629)	0.298 (0.184 to 0.436)
ADA	0.507 (0.323 to 0.692)	0.272 (0.133 to 0.457)	0.136 (0.054 to 0.276)
ETN + MTX	0.785 (0.612 to 0.903)	0.566 (0.360 to 0.754)	0.370 (0.195 to 0.578)
ETN	0.668 (0.466 to 0.829)	0.424 (0.235 to 0.632)	0.246 (0.112 to 0.441)
IFX + MTX	0.828 (0.697 to 0.935)	0.627 (0.453 to 0.815)	0.432 (0.268 to 0.656)
GOL + MTX	0.686 (0.481 to 0.844)	0.445 (0.245 to 0.653)	0.263 (0.116 to 0.464)
Intensive cDMARDs	0.766 (0.586 to 0.904)	0.542 (0.339 to 0.754)	0.348 (0.179 to 0.577)
Step-up intensive cDMARDs	0.639 (0.446 to 0.827)	0.395 (0.219 to 0.626)	0.223 (0.101 to 0.432)



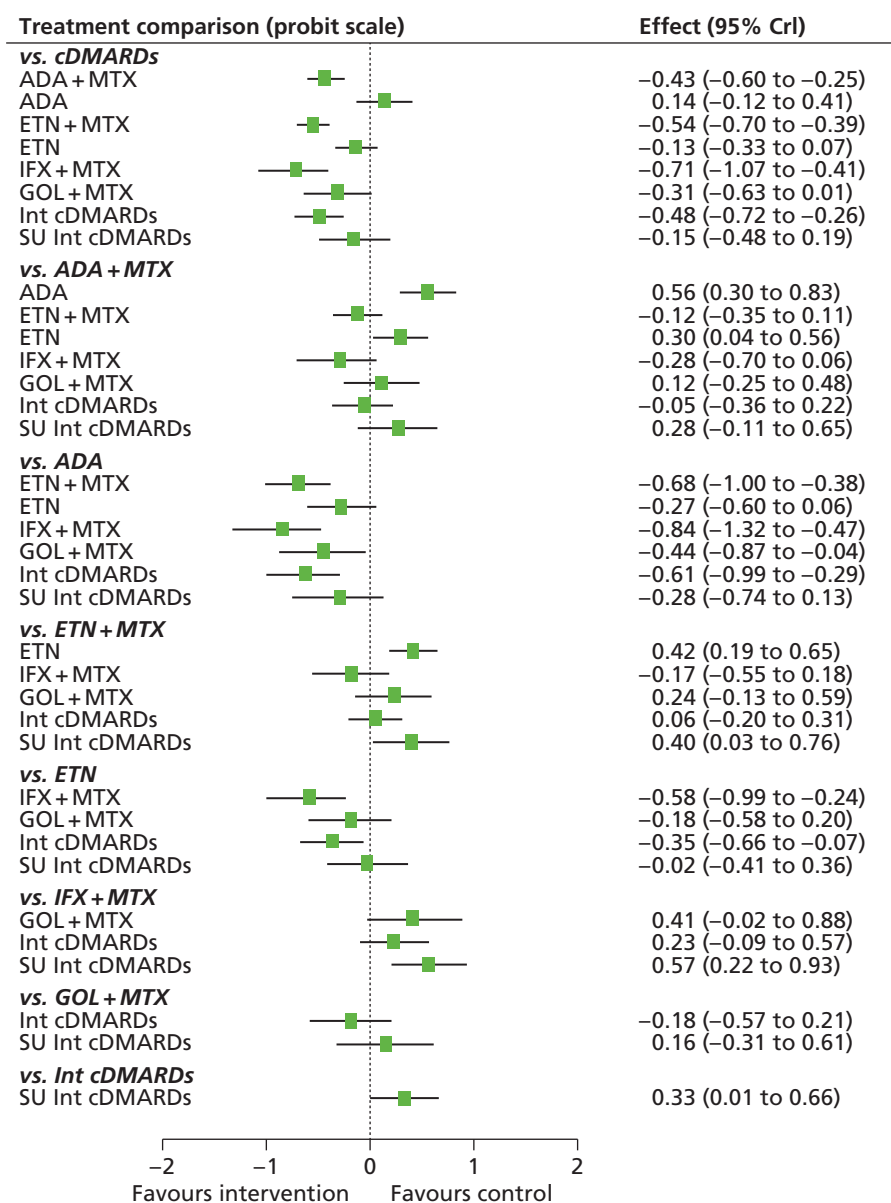
**FIGURE 7** American College of Rheumatology (population 1: main trials + MTX experienced) – network of evidence. Int, intensive; SU, step-up. Solid green line (two-arm study); dotted blue line (three-arm study); and dotted green line (four-arm study).

**TABLE 26** American College of Rheumatology (population 1: main trials + MTX experienced) – the number of RCTs with which each pair of interventions were compared

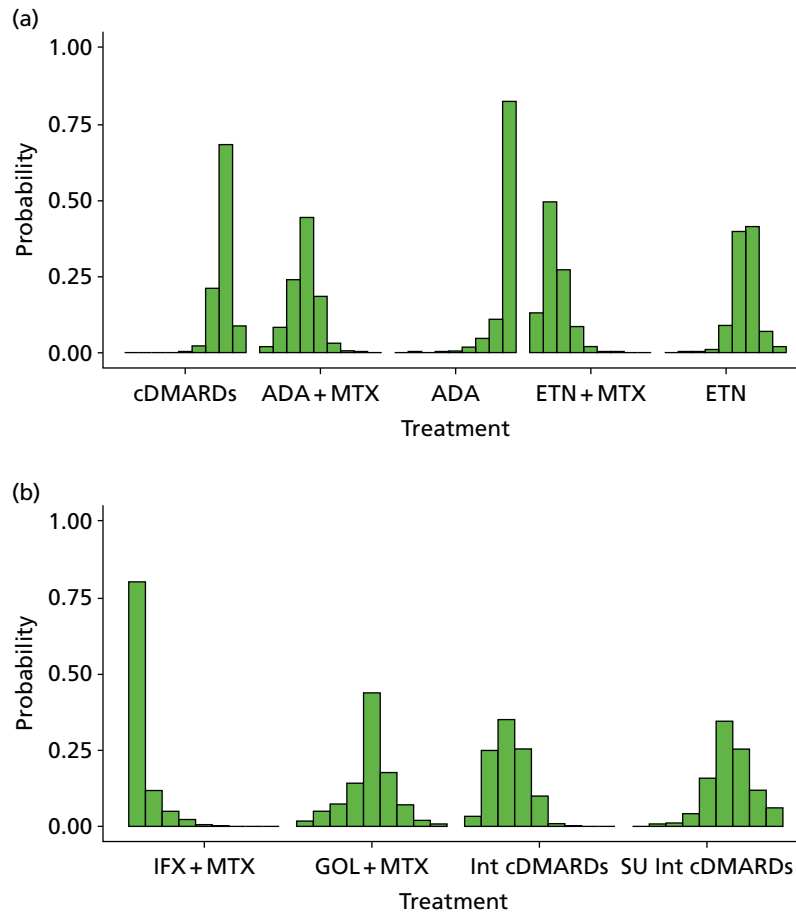
Intervention	cDMARDs	ADA + MTX	ADA	ETN + MTX	ETN	IFX + MTX	GOL + MTX	Intensive cDMARDs	Step-up intensive cDMARDs
cDMARDs	–	3	1	3	2	2	1	8	
ADA + MTX	–	–	1						
ADA	–	–	–						
ETN + MTX	–	–	–	–	1			1	
ETN	–	–	–	–	–				
IFX + MTX	–	–	–	–	–	–		1	
GOL + MTX	–	–	–	–	–	–	–		
Intensive cDMARDs	–	–	–	–	–	–	–	–	
Step-up intensive cDMARDs	–	–	–	–	–	–	–	–	–

Figure 8 presents the effects of each intervention relative to cDMARDs on the probit scale, and Figure 9 and Table 27 presents the probabilities of treatment rankings.

The model fitted the data reasonably well, with the total residual deviance, 84.19, close to the total number of data points, 71, included in the analysis. The largest residual deviances were 5.89 and 3.92 from the Patients REceiving Methotrexate and Infliximab for the treatment of Early Rheumatoid arthritis (PREMIER) study<sup>109</sup> and 4.08 from the BeST study.<sup>78</sup>



**FIGURE 8** American College of Rheumatology (population 1: main trials + MTX experienced) – effects of interventions relative to cDMARDs on the probit scale. Int, intensive; SU, step-up.



**FIGURE 9** American College of Rheumatology (population1: main trials + MTX experienced) – probability of treatment rankings in terms of efficacy (most efficacious = 1). Int, intensive; SU, step-up.

**TABLE 27** American College of Rheumatology (population 1: main trials + MTX experienced) – probability of treatment rankings in terms of efficacy (most efficacious = 1)

Intervention	Rank (mean)	Rank								
		1	2	3	4	5	6	7	8	9
cDMARDs	7.8	0.000	0.000	0.000	0.001	0.021	0.032	0.210	0.683	0.086
ADA + MTX	3.8	0.018	0.240	0.443	0.184	0.029	0.032	0.004	0.001	0.000
ADA	8.7	0.000	0.000	0.001	0.004	0.016	0.020	0.045	0.108	0.825
ETN + MTX	2.4	0.130	0.271	0.083	0.020	0.002	0.008	0.000	0.000	0.000
ETN	6.5	0.000	0.002	0.009	0.089	0.398	0.075	0.413	0.068	0.020
IFX + MTX	1.3	0.801	0.050	0.024	0.006	0.001	0.001	0.000	0.000	0.000
GOL + MTX	4.9	0.017	0.074	0.143	0.439	0.177	0.509	0.072	0.021	0.008
Intensive cDMARDs	3.2	0.034	0.351	0.255	0.100	0.009	0.033	0.001	0.000	0.000
Step-up intensive cDMARDs	6.4	0.000	0.012	0.042	0.157	0.346	0.290	0.255	0.119	0.062



The between-study SD was estimated to be 0.07 (95% CrI 0.00 to 0.26), which implies mild heterogeneity between studies in intervention effects. The addition of the studies including patients who were MTX experienced has reduced the estimate of the between-study SD.

All interventions except for ADA were associated with beneficial treatment effects relative to cDMARDs, with the greatest effect being associated with IFX plus MTX. However, the treatment effects were statistically significant only for ADA plus MTX, ETN plus MTX, IFX plus MTX and intensive cDMARDs at a conventional 5% level. IFX plus MTX (mean rank 1.3; probability of being the best 0.801) was the treatment that was most likely to be the most effective intervention.

A meta-analysis was used to estimate the proportion of patients experiencing an ACR 'no response' when treated with cDMARDs.

Data were available from 10 studies.<sup>53,54,78,81,86,87,90,94,108,109</sup>

The model fitted the data well, with the total residual deviance, 10.95, close to the total number of data points, 10, included in the analysis.

The between-study SD was estimated to be 0.32 (95% CrI 0.18 to 0.62), which implies mild to moderate heterogeneity between studies in the baseline response.

Table 28 presents the probabilities of achieving at least an ACR20 response, an ACR50 response and an ACR70 response. These are derived by combining the treatment effects estimated from the NMA with the estimate of the cDMARDs 'no response' rate.

### Populations 2 and 3 (methotrexate-experienced populations)

#### European League Against Rheumatism: main trials

A NMA was used to compare the effects of ABT i.v. plus MTX, ADA (with and without MTX), intensive cDMARDs, ETN (with and without MTX), GOL plus MTX, IFX plus MTX, PBO, TCZ (with and without MTX), the grouped biologics (from the TACIT RCT<sup>141</sup>) and CTZ plus MTX relative to cDMARDs on EULAR response.

Data were available from 15 studies comparing two or three interventions.<sup>57,58,74,76,79,91,92,102,116,118,119,121,122,140,141</sup>

**TABLE 28** American College of Rheumatology (population 1: main trials + MTX experienced) – probabilities of achieving ACR responses

Intervention	At least ACR20 (95% CrI)	At least ACR50 (95% CrI)	At least ACR70 (95% CrI)
cDMARDs	0.559 (0.464 to 0.650)	0.306 (0.218 to 0.406)	0.144 (0.090 to 0.216)
ADA + MTX	0.718 (0.613 to 0.806)	0.468 (0.344 to 0.595)	0.263 (0.168 to 0.379)
ADA	0.504 (0.356 to 0.640)	0.259 (0.153 to 0.394)	0.115 (0.056 to 0.205)
ETN + MTX	0.756 (0.658 to 0.837)	0.515 (0.391 to 0.637)	0.302 (0.201 to 0.422)
ETN	0.608 (0.486 to 0.721)	0.352 (0.236 to 0.482)	0.174 (0.101 to 0.276)
IFX + MTX	0.805 (0.683 to 0.901)	0.582 (0.421 to 0.738)	0.364 (0.224 to 0.533)
GOL + MTX	0.676 (0.525 to 0.805)	0.420 (0.268 to 0.588)	0.224 (0.119 to 0.373)
Intensive cDMARDs	0.737 (0.621 to 0.832)	0.491 (0.355 to 0.630)	0.282 (0.174 to 0.413)
Step-up intensive cDMARDs	0.616 (0.455 to 0.761)	0.360 (0.216 to 0.527)	0.180 (0.089 to 0.313)

Figure 10 presents the network of evidence and Table 29 presents the frequency with which each pair of treatments was compared. There are 13 treatment effects to estimate from 15 studies.<sup>57,58,74,76,79,91,92,102,116,118,119,121,122,140,141</sup>

Figure 11 presents the effects of each intervention relative to cDMARDs on the probit scale and Figure 12 and Table 30 present the probabilities of treatment rankings.

The model fitted the data well, with the total residual deviance, 59.57, close to the total number of data points, 52, included in the analysis.

The between-study SD was estimated to be 0.38 (95% CrI 0.18 to 0.73), which implies mild to moderate heterogeneity between studies in intervention effects.

All interventions were associated with beneficial treatment effects relative to cDMARDs, with the greatest effects being associated with TCZ, TCZ plus MTX and ETN plus MTX. However, the treatment effects were statistically significant only for GL plus MTX, TCZ and TCZ plus MTX at a conventional 5% level. There was insufficient evidence to differentiate between treatments, although TCZ was ranked highest and was the treatment that was most likely to be the most effective intervention (mean rank 2.4; probability of being the best 0.377).

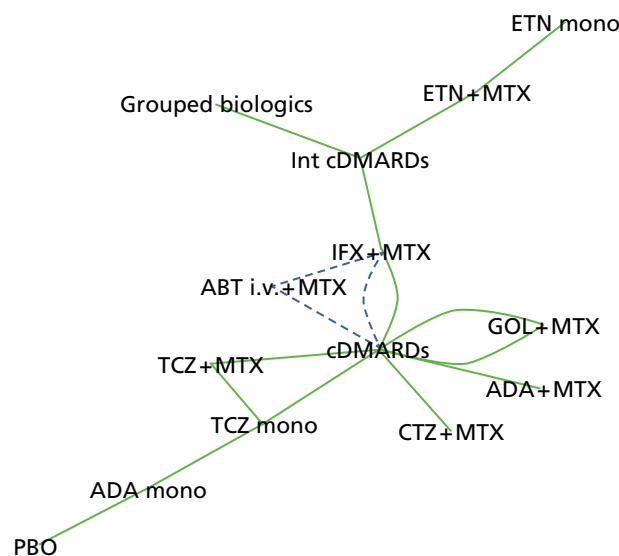
A meta-analysis was used to estimate the proportion of patients experiencing a EULAR 'no response' when treated with cDMARDs.

Data were available from eight studies.<sup>74,76,79,91,92,116,118,121</sup>

The model fitted the data well, with the total residual deviance, 8.63, close to the total number of data points, 8, included in the analysis.

The between-study SD was estimated to be 0.18 (95% CrI 0.05 to 0.44), which implies mild heterogeneity between studies in the baseline response.

Table 31 presents the probabilities of achieving at least a moderate and at least a good EULAR response. These are derived by combining the treatment effects estimated from the NMA with the estimate of the cDMARDs 'no response' rate.



**FIGURE 10** European League Against Rheumatism (populations 2 and 3: main trials) – network of evidence. Int, intensive; mono, monotherapy. Solid green line (two-arm study); and dotted blue line (three-arm study).

**TABLE 29** European League Against Rheumatism (populations 2 and 3: main trials) – the number of RCTs with which each pair of interventions were compared

Intervention	ABT		Intensive cDMARDs		ETN + MTX	ETN	GOL + MTX	IFX + MTX	PBO	TCZ + MTX	TCZ	Grouped biologics	CTZ + MTX
	i.v. + MTX	ADA + MTX	ADA	cDMARDs									
cDMARDs	1	1				2	2	2		1	1		1
ABT i.v. + MTX	-						1						
ADA + MTX	-	-											
ADA	-	-	-						1		1		
Intensive cDMARDs	-	-	-		1		1					1	
ETN + MTX	-	-	-		-	1							
ETN	-	-	-		-	-							
GOL + MTX	-	-	-		-	-							
IFX + MTX	-	-	-		-	-							
PBO	-	-	-		-	-			-				
TCZ + MTX	-	-	-		-	-			-		1		
TCZ	-	-	-		-	-			-		-		
Grouped biologics	-	-	-		-	-			-		-		
CTZ + MTX	-	-	-		-	-			-		-		-

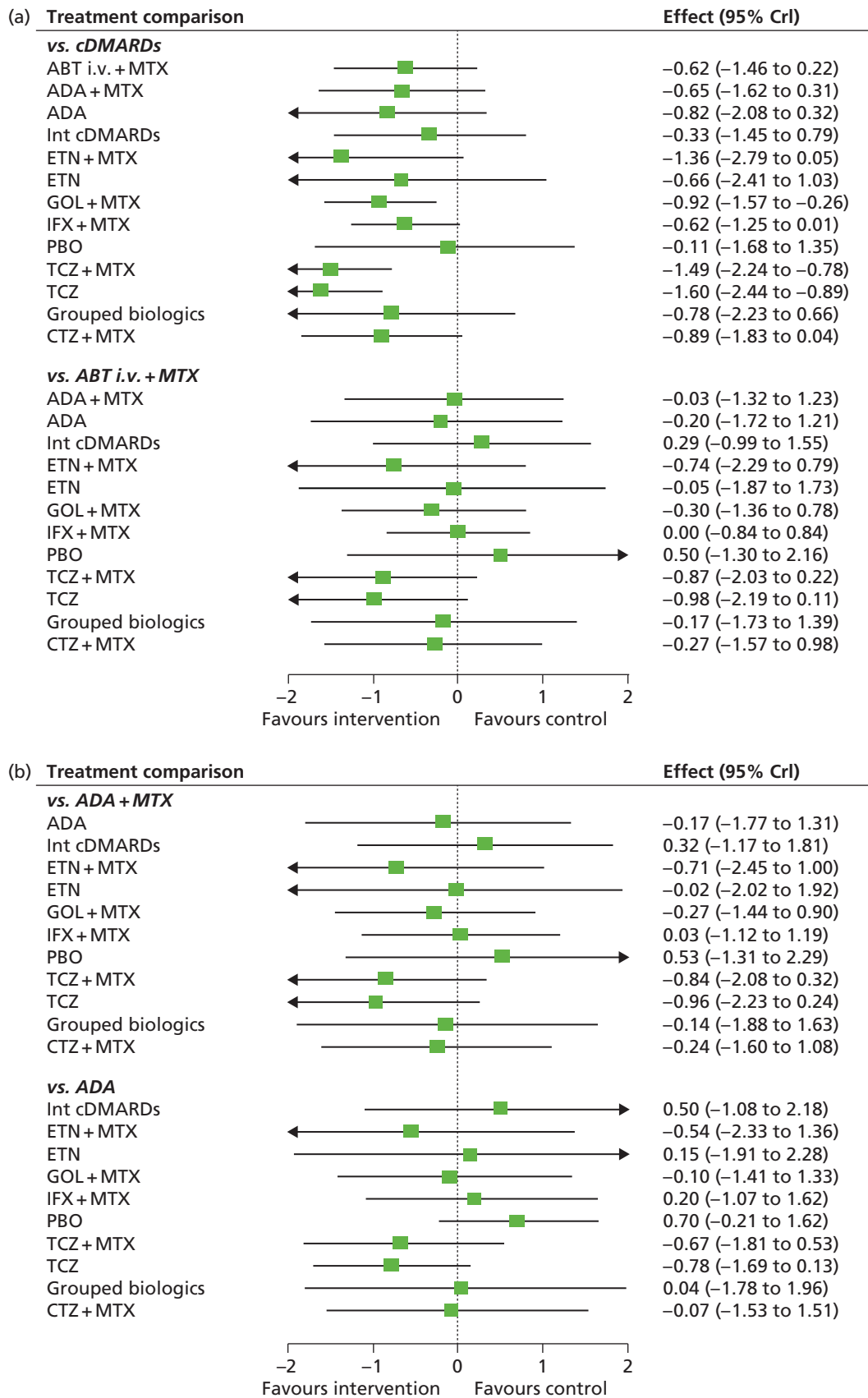


FIGURE 11 European League Against Rheumatism (populations 2 and 3: main trials) – effects of interventions relative to cDMARDs on the probit scale. Int, intensive. (continued)

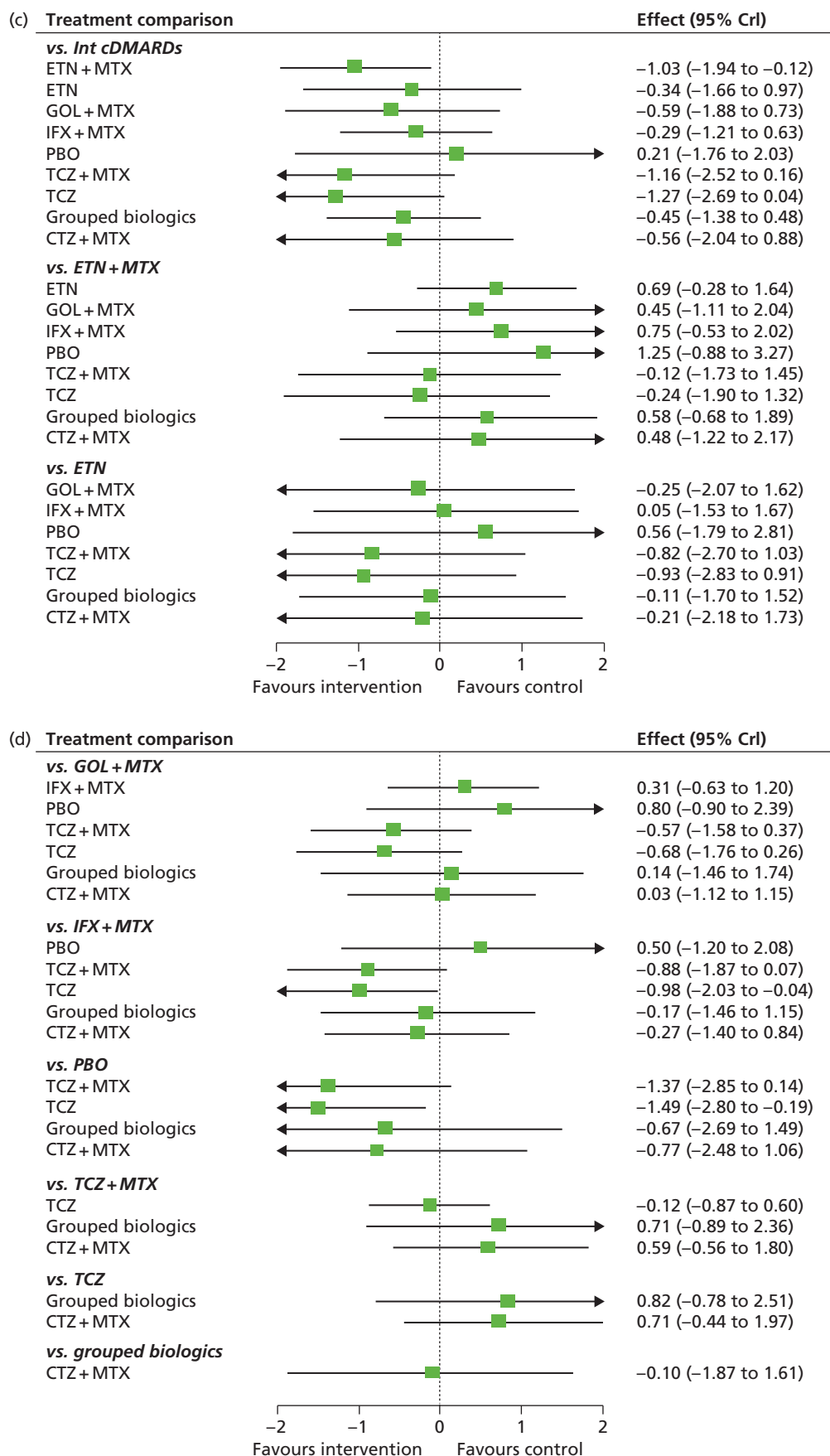
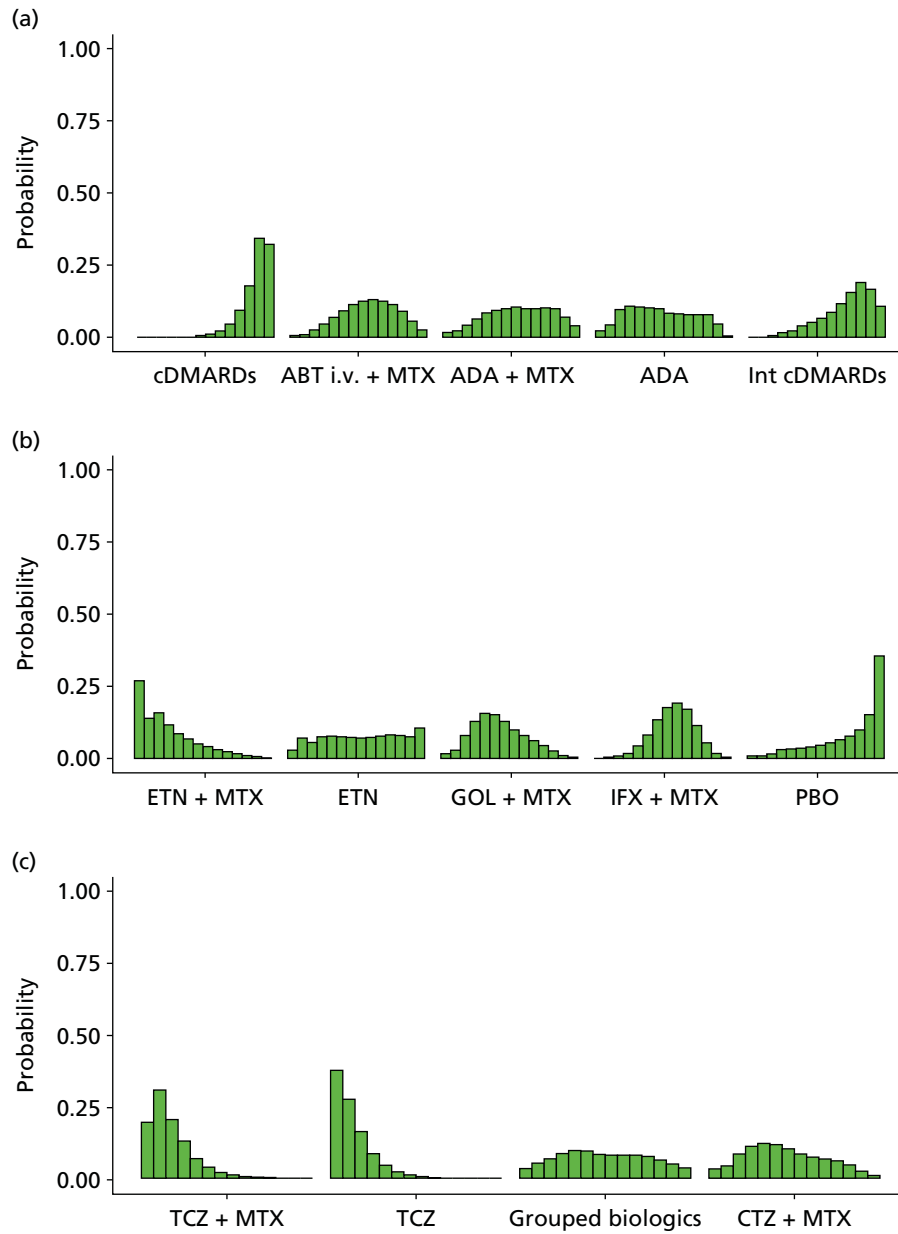


FIGURE 11 European League Against Rheumatism (populations 2 and 3: main trials) – effects of interventions relative to cDMARDs on the probit scale. Int, intensive.



**FIGURE 12** European League Against Rheumatism (populations 2 and 3: main trials) – probability of treatment rankings in terms of efficacy (most efficacious = 1). Int, intensive.

**TABLE 30** European League Against Rheumatism (populations 2 and 3: main trials) – probability of treatment rankings in terms of efficacy (most efficacious = 1)

Intervention	Rank (mean)	Rank													
		1	2	3	4	5	6	7	8	9	10	11	12	13	14
cDMARDs	12.7	0.000	0.000	0.000	0.000	0.000	0.001	0.002	0.008	0.019	0.044	0.090	0.176	0.340	0.319
ABT i.v. + MTX	8.6	0.006	0.010	0.023	0.043	0.067	0.090	0.111	0.123	0.129	0.122	0.112	0.089	0.052	0.023
ADA+MTX	8.3	0.015	0.020	0.041	0.061	0.081	0.092	0.096	0.102	0.096	0.096	0.100	0.096	0.067	0.038
ADA	7.1	0.020	0.041	0.093	0.105	0.104	0.100	0.098	0.083	0.079	0.077	0.075	0.075	0.045	0.004
Intensive cDMARDs	10.7	0.000	0.001	0.006	0.014	0.020	0.037	0.050	0.066	0.085	0.114	0.153	0.187	0.165	0.104
ETN + MTX	3.8	0.268	0.139	0.158	0.116	0.085	0.067	0.048	0.039	0.030	0.022	0.016	0.009	0.004	0.001
ETN	8.2	0.027	0.068	0.054	0.073	0.078	0.073	0.072	0.068	0.071	0.077	0.082	0.079	0.074	0.104
GOL + MTX	6.4	0.015	0.030	0.080	0.127	0.155	0.150	0.126	0.099	0.078	0.060	0.042	0.025	0.010	0.002
IFX + MTX	8.6	0.000	0.002	0.007	0.016	0.042	0.080	0.134	0.175	0.191	0.168	0.113	0.053	0.016	0.003
PBO	11.2	0.006	0.008	0.013	0.028	0.030	0.033	0.040	0.045	0.053	0.064	0.075	0.098	0.151	0.354
TCZ + MTX	3.0	0.194	0.308	0.205	0.131	0.070	0.041	0.022	0.014	0.008	0.004	0.002	0.001	0.000	0.000
TCZ	2.4	0.377	0.275	0.164	0.087	0.047	0.023	0.013	0.007	0.004	0.002	0.001	0.000	0.000	0.000
Grouped biologics	7.4	0.037	0.054	0.070	0.087	0.099	0.095	0.083	0.082	0.081	0.082	0.078	0.064	0.051	0.037
CTZ + MTX	6.7	0.034	0.044	0.087	0.111	0.123	0.118	0.104	0.088	0.076	0.068	0.061	0.047	0.025	0.012

**TABLE 31** European League Against Rheumatism (populations 2 and 3: main trials) – probability of achieving EULAR responses

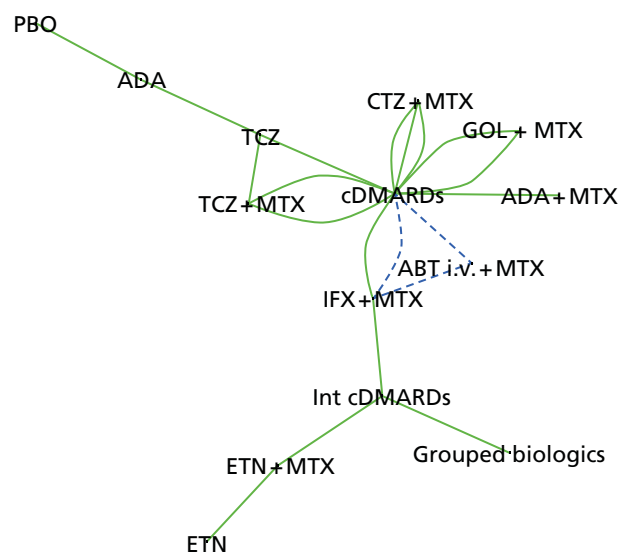
Intervention	At least moderate (95% CrI)	At least good (95% CrI)
cDMARDs	0.451 (0.384 to 0.520)	0.094 (0.058 to 0.144)
ABT i.v. + MTX	0.690 (0.358 to 0.913)	0.242 (0.058 to 0.571)
ADA + MTX	0.700 (0.330 to 0.934)	0.252 (0.049 to 0.631)
ADA	0.757 (0.328 to 0.975)	0.311 (0.050 to 0.781)
Intensive cDMARDs	0.581 (0.180 to 0.910)	0.162 (0.017 to 0.567)
ETN + MTX	0.893 (0.426 to 0.996)	0.519 (0.082 to 0.931)
ETN	0.706 (0.121 to 0.989)	0.257 (0.009 to 0.867)
GOL + MTX	0.786 (0.545 to 0.929)	0.345 (0.134 to 0.620)
IFX + MTX	0.688 (0.436 to 0.874)	0.241 (0.084 to 0.490)
PBO	0.495 (0.070 to 0.942)	0.115 (0.004 to 0.648)
TCZ + MTX	0.914 (0.738 to 0.984)	0.568 (0.283 to 0.833)
TCZ	0.930 (0.770 to 0.990)	0.613 (0.319 to 0.875)
Grouped biologics	0.746 (0.211 to 0.983)	0.298 (0.022 to 0.823)
CTZ + MTX	0.779 (0.428 to 0.957)	0.336 (0.082 to 0.708)

**European League Against Rheumatism: main trials plus prior biologics**

A NMA was used to compare the effects of ABT i.v. plus MTX, ADA (with and without MTX), intensive cDMARDs, ETN (with and without MTX), GOL plus MTX, IMFX plus MTX, PBO, TCZ (with and without MTX), the grouped biologics (from the TACIT RCT<sup>141</sup>) and CTZ plus MTX relative to cDMARDs on EULAR response.

Data were available from 18 studies comparing two or three interventions.<sup>57,58,74,76,79,91,92,102,116,118,119,121,122,132,135,139–141</sup>

Figure 13 presents the network of evidence and Table 32 presents the frequency with which each pair of treatments was compared. There are 13 treatment effects to estimate from 18 studies.<sup>57,58,74,76,79,91,92,102,116,118,119,121,122,132,135,139–141</sup>



**FIGURE 13** European League Against Rheumatism (populations 2 and 3: main trials + prior biologics) – network of evidence. Int, intensive. Solid green line (two-arm study); and dotted blue line (three-arm study).



**TABLE 32** European League Against Rheumatism (populations 2 and 3: main trials + prior biologics) – the number of RCTs with which each pair of interventions were compared

Intervention	cDMARDs	ABT i.v. + MTX	ADA + MTX	ADA	Intensive cDMARDs	ETN + MTX	ETN	GOL + MTX	IFX + MTX	PBO	TCZ + MTX	TCZ	Grouped biologics	CTZ + MTX
cDMARDs	–	1	1	–	–	–	–	2	2	–	2	1	–	3
ABT i.v. + MTX	–	–	–	–	–	1	–	–	1	–	–	–	–	–
ADA + MTX	–	–	–	–	–	–	–	–	–	–	–	–	–	–
ADA	–	–	–	–	–	–	–	–	–	1	–	1	–	–
Intensive cDMARDs	–	–	–	–	–	1	–	–	1	–	–	–	1	–
ETN + MTX	–	–	–	–	–	–	1	–	–	–	–	–	–	–
ETN	–	–	–	–	–	–	–	–	–	–	–	–	–	–
GOL + MTX	–	–	–	–	–	–	–	–	–	–	–	–	–	–
IFX + MTX	–	–	–	–	–	–	–	–	–	–	–	–	–	–
PBO	–	–	–	–	–	–	–	–	–	–	–	–	–	–
TCZ + MTX	–	–	–	–	–	–	–	–	–	–	–	1	–	–
TCZ	–	–	–	–	–	–	–	–	–	–	–	–	–	–
Grouped biologics	–	–	–	–	–	–	–	–	–	–	–	–	–	–
CTZ + MTX	–	–	–	–	–	–	–	–	–	–	–	–	–	–

Figure 14 presents the effects of each intervention relative to cDMARDs on the probit scale and Figure 15 and Table 33 present the probabilities of treatment rankings.

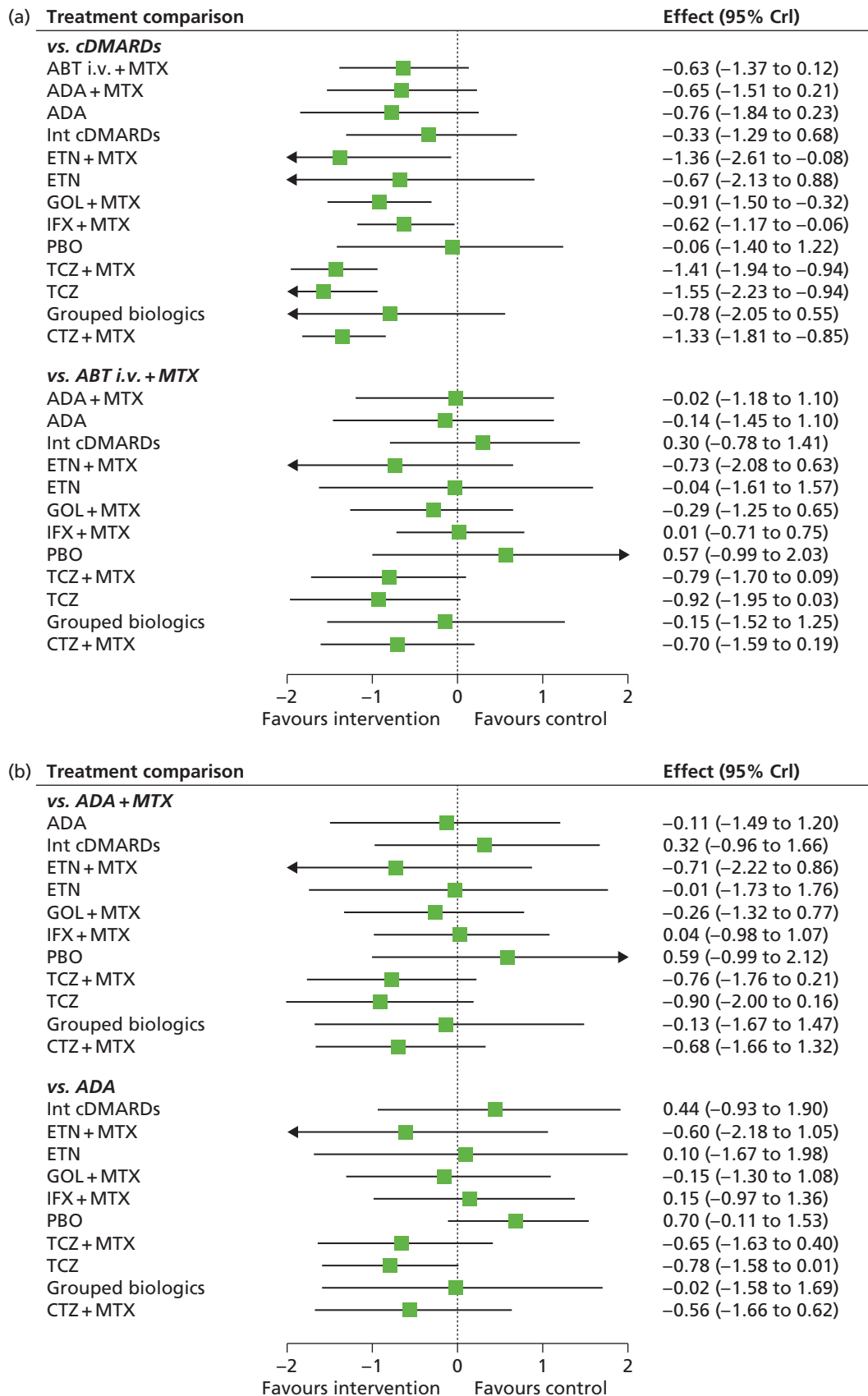


FIGURE 14 European League Against Rheumatism (populations 2 and 3: main trials + prior biologics) – effects of interventions relative to cDMARDs on the probit scale. Int, intensive. (continued)

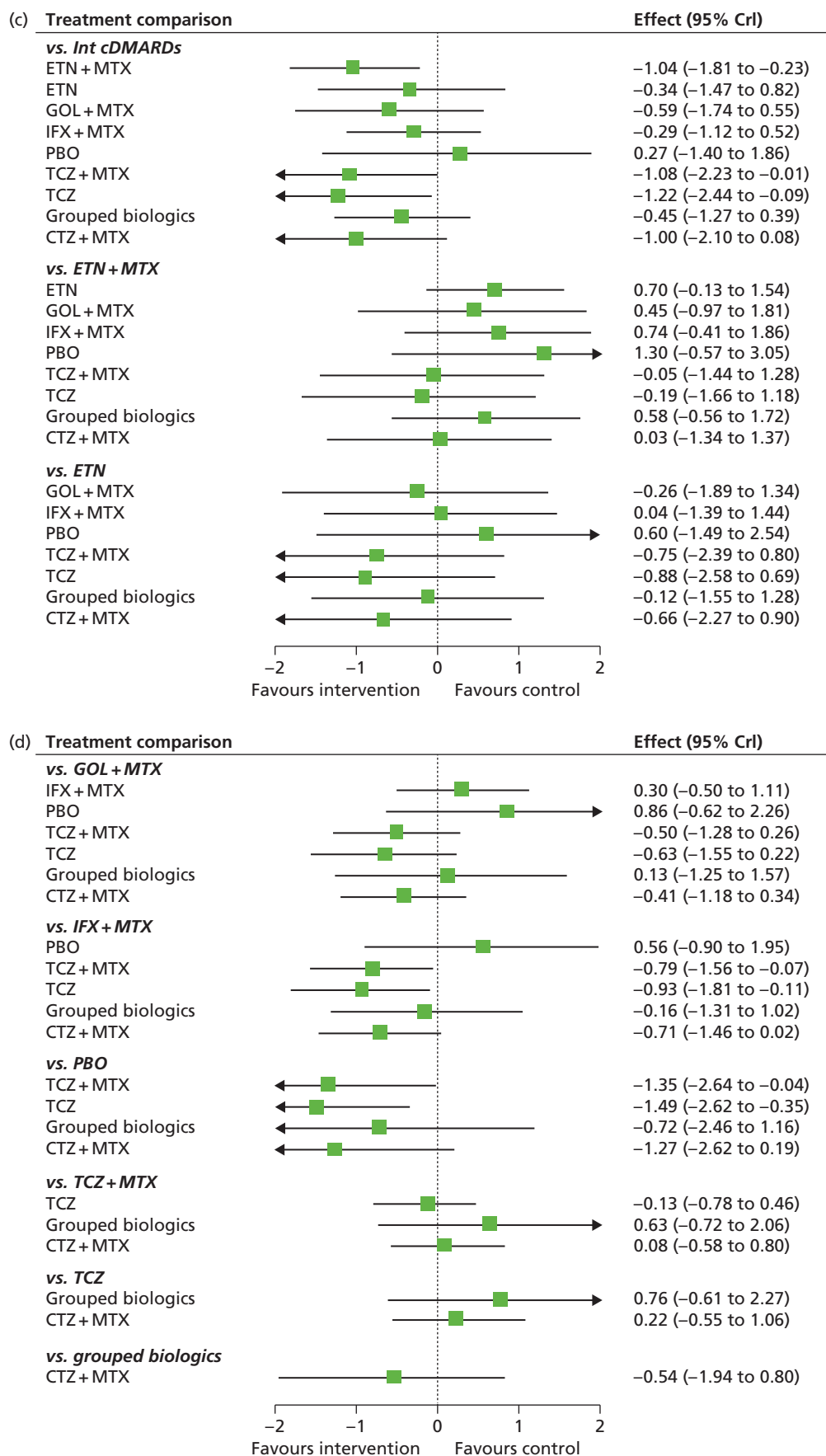
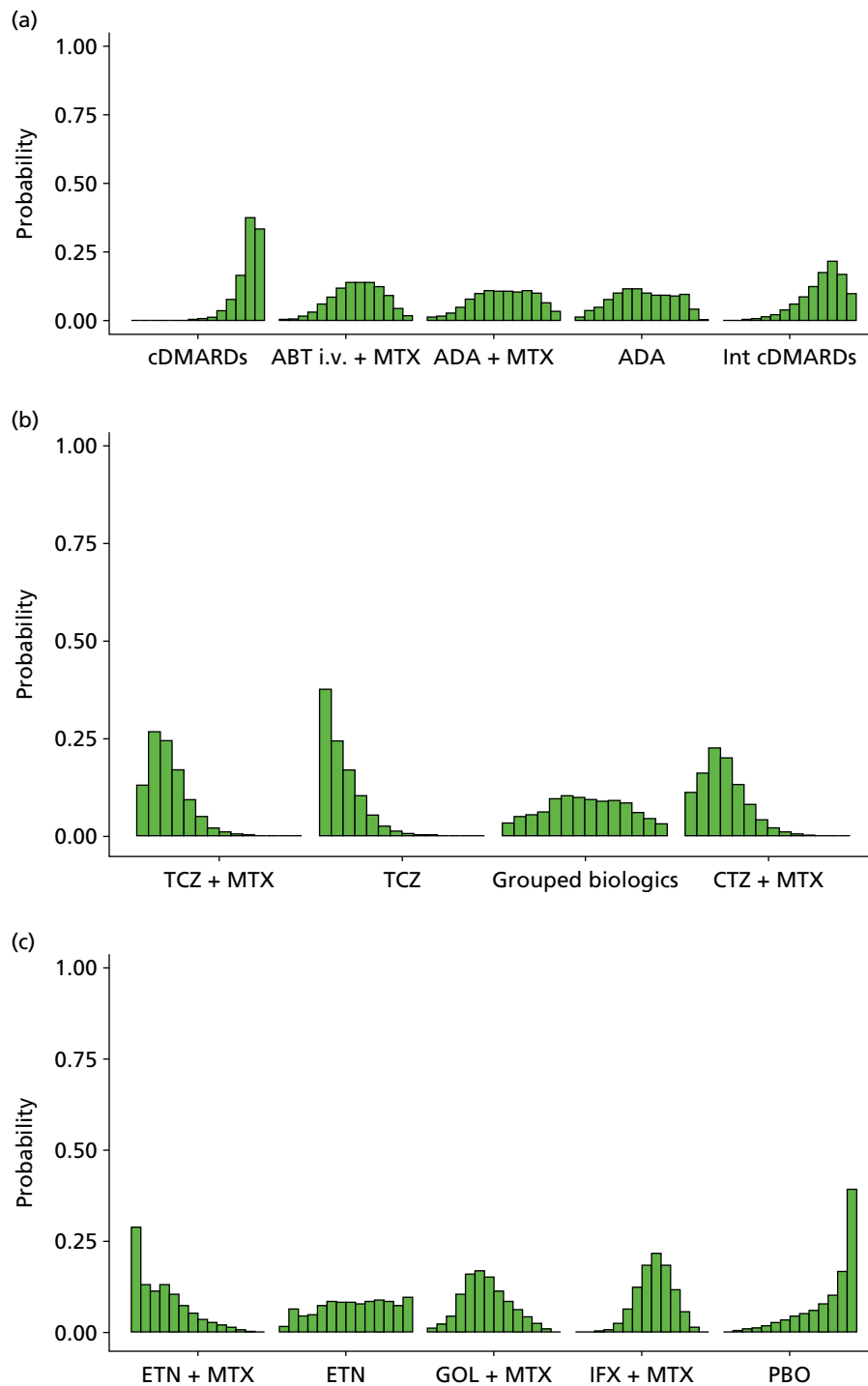


FIGURE 14 European League Against Rheumatism (populations 2 and 3: main trials + prior biologics) – effects of interventions relative to cDMARDs on the probit scale. Int, intensive.



**FIGURE 15** European League Against Rheumatism (populations 2 and 3: main trials + prior biologics) – probability of treatment rankings in terms of efficacy (most efficacious = 1). Int, intensive.

**TABLE 33** European League Against Rheumatism (populations 2 and 3: main trials+ prior biologics) – probability of treatment rankings in terms of efficacy (most efficacious = 1)

Intervention	Rank (mean)	Rank													
		1	2	3	4	5	6	7	8	9	10	11	12	13	14
cDMARDs	12.8	0.000	0.000	0.000	0.000	0.000	0.000	0.001	0.005	0.013	0.035	0.076	0.164	0.372	0.333
ABT i.v. + MTX	8.7	0.004	0.006	0.015	0.030	0.058	0.085	0.118	0.138	0.136	0.136	0.122	0.091	0.045	0.016
ADA + MTX	8.5	0.012	0.014	0.026	0.047	0.075	0.096	0.109	0.107	0.107	0.103	0.108	0.100	0.065	0.031
ADA	7.6	0.013	0.035	0.048	0.075	0.099	0.114	0.113	0.098	0.090	0.090	0.088	0.093	0.040	0.003
Intensive cDMARDs	11.0	0.000	0.001	0.003	0.007	0.011	0.020	0.039	0.059	0.085	0.123	0.172	0.215	0.168	0.096
ETN + MTX	3.7	0.287	0.131	0.113	0.131	0.104	0.074	0.054	0.036	0.027	0.020	0.013	0.007	0.002	0.000
ETN	8.4	0.017	0.064	0.046	0.048	0.073	0.085	0.082	0.082	0.079	0.084	0.089	0.084	0.073	0.095
GOL + MTX	6.7	0.011	0.022	0.045	0.105	0.159	0.169	0.151	0.113	0.084	0.063	0.043	0.024	0.009	0.001
IFX + MTX	8.9	0.000	0.000	0.002	0.008	0.025	0.065	0.121	0.185	0.218	0.185	0.118	0.057	0.015	0.001
PBO	11.7	0.003	0.004	0.008	0.012	0.018	0.027	0.034	0.045	0.050	0.059	0.079	0.103	0.166	0.392
TCZ + MTX	3.2	0.131	0.267	0.244	0.170	0.095	0.050	0.022	0.012	0.005	0.003	0.001	0.000	0.000	0.000
TCZ	2.4	0.377	0.243	0.169	0.103	0.054	0.026	0.013	0.006	0.004	0.002	0.001	0.000	0.000	0.000
Grouped biologics	7.5	0.033	0.050	0.055	0.063	0.095	0.105	0.101	0.094	0.091	0.091	0.085	0.061	0.044	0.032
CTZ + MTX	3.7	0.113	0.162	0.225	0.200	0.133	0.082	0.042	0.021	0.011	0.006	0.003	0.001	0.000	0.000

The model fitted the data well, with the total residual deviance, 70.90, close to the total number of data points, 60, included in the analysis.

The between-study SD was estimated to be 0.34 (95% CrI 0.17 to 0.62), which implies mild to moderate heterogeneity between studies in intervention effects. The addition of the studies including patients who had received prior biologics resulted in a small reduction in the estimate of the between-study SD.

All interventions were associated with beneficial treatment effects relative to cDMARDs, with the greatest effects being associated with TCZ, TCZ plus MTX, ETN plus MTX and CTZ plus MTX. However, the treatment effects were statistically significant only for ETN plus MTX, GOL plus MTX, IFX plus MTX, TCZ plus MTX, TCZ and CTZ plus MTX at a conventional 5% level. There was insufficient evidence to differentiate between treatments, although TCZ was ranked highest and was the treatment that was most likely to be the most effective intervention (mean rank 2.4; probability of being the best 0.377). The addition of the studies including patients who had received prior biologics had the greatest impact on the estimate of the effect of CTZ plus MTX.

A meta-analysis was used to estimate the proportion of patients experiencing a EULAR 'no response' when treated with cDMARDs.

Data were available from 11 studies.<sup>74,76,79,91,92,116,118,121,129,132,135</sup>

The model fitted the data well, with the total residual deviance, 11.42, close to the total number of data points, 11, included in the analysis.

The between-study SD was estimated to be 0.24 (95% CrI 0.13 to 0.46), which implies mild heterogeneity between studies in the baseline response.

*Table 34* presents the probabilities of achieving at least a moderate and at least a good EULAR response. These are derived by combining the treatment effects estimated from the NMA with the estimate of the cDMARDs 'no response' rate.

### American College of Rheumatology: main trials

A NMA was used to compare the effects of ABT i.v. plus MTX, ADA (with and without MTX), intensive cDMARDs, ETN (with and without MTX), GOL plus MTX, IFX plus MTX, PBO, TCZ (with and without MTX), CTZ plus MTX and ABT s.c. plus MTX relative to cDMARDs on ACR response.

Data were available from 28 studies comparing two or three interventions.<sup>57,58,62,66,69,70,74-76,79,80,84,85,89,91,92,96,99,102,105,112,115-118,121,122,124,140,160</sup>

*Figure 16* presents the network of evidence and *Table 35* presents the frequency with which each pair of treatments was compared. There were 13 treatment effects to estimate from 28 studies.

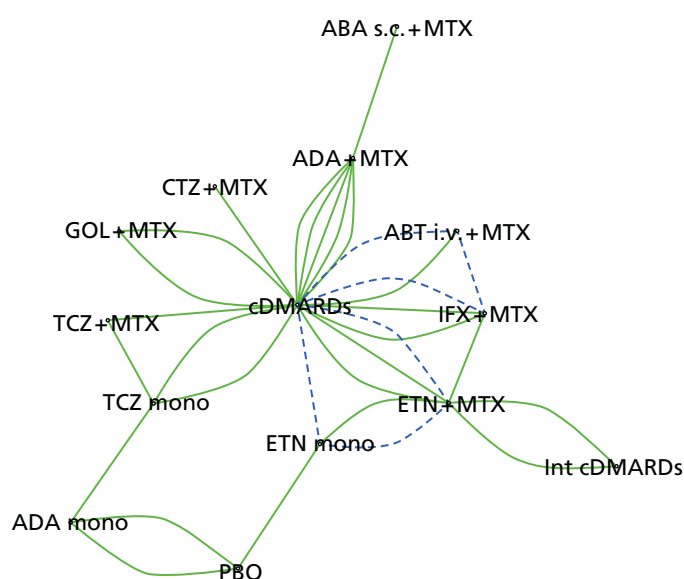
*Figure 17* presents the effects of each intervention relative to cDMARDs on the probit scale and *Figure 18* and *Table 36* present the probabilities of treatment rankings.

The model fitted the data well, with the total residual deviance, 185.61, close to the total number of data points, 174, included in the analysis. The largest residual deviances were 7.24 and 3.86 from O'Dell *et al.*,<sup>111</sup> and 4.99 from the Anti-TNF factor Research study program of the Monoclonal antibody Adalimumab (D2E7) in rheumatoid Arthritis (ARMADA) study.<sup>69</sup>

The between-study SD was estimated to be 0.24 (95% CrI 0.14 to 0.40), which implies mild heterogeneity between studies in intervention effects.

**TABLE 34** European League Against Rheumatism (populations 2 and 3: main trials) – probability of achieving EULAR responses

Intervention	At least moderate (95% CrI)	At least good (95% CrI)
cDMARDs	0.410 (0.344 to 0.479)	0.077 (0.048 to 0.117)
ABT i.v. + MTX	0.655 (0.356 to 0.878)	0.212 (0.057 to 0.494)
ADA + MTX	0.664 (0.327 to 0.903)	0.220 (0.048 to 0.546)
ADA	0.704 (0.321 to 0.948)	0.254 (0.047 to 0.669)
Intensive cDMARDs	0.539 (0.178 to 0.863)	0.136 (0.016 to 0.463)
ETN + MTX	0.871 (0.437 to 0.992)	0.473 (0.085 to 0.886)
ETN	0.670 (0.132 to 0.973)	0.224 (0.010 to 0.772)
GOL + MTX	0.754 (0.528 to 0.902)	0.305 (0.126 to 0.545)
IFX + MTX	0.652 (0.424 to 0.832)	0.210 (0.079 to 0.416)
PBO	0.433 (0.071 to 0.883)	0.086 (0.004 to 0.500)
TCZ + MTX	0.88 (0.751 to 0.958)	0.495 (0.293 to 0.710)
TCZ	0.907 (0.752 to 0.979)	0.550 (0.298 to 0.800)
Grouped biologics	0.711 (0.217 to 0.967)	0.260 (0.023 to 0.743)
CTZ + MTX	0.864 (0.722 to 0.946)	0.462 (0.263 to 0.668)

**FIGURE 16** American College of Rheumatology (populations 2 and 3: main trials) – network of evidence. Int, intensive; mono, monotherapy. Solid green line (two-arm study); and dotted blue line (three-arm study).

**TABLE 35** American College of Rheumatology (populations 2 and 3: main trials) – frequency with which each pair of interventions were compared

Intervention	cDMARDs	ABT i.v. + MTX	ADA + MTX	ADA	Intensive cDMARDs	ETN + MTX	ETN	GOL + MTX	IFX + MTX	PBO	TCZ + MTX	TCZ	CTZ + MTX	ABT s.c. + MTX
cDMARDs	-	2	5	-	3	1	2	3	1	1	2	1		
ABT i.v. + MTX	-	-	-	-	-	-	-	1	3	-	-	-	-	-
ADA + MTX	-	-	-	-	-	-	-	-	-	-	-	-	-	1
ADA	-	-	-	-	-	-	-	-	-	2	-	1	-	-
Intensive cDMARDs	-	-	-	-	2	-	-	-	-	-	-	-	-	-
ETN + MTX	-	-	-	-	-	2	-	1	-	-	-	-	-	-
ETN	-	-	-	-	-	-	-	-	-	1	-	-	-	-
GOL + MTX	-	-	-	-	-	-	-	-	-	-	-	-	-	-
IFX + MTX	-	-	-	-	-	-	-	-	-	-	-	-	-	-
PBO	-	-	-	-	-	-	-	-	-	-	-	-	-	-
TCZ + MTX	-	-	-	-	-	-	-	-	-	-	-	1	-	-
TCZ	-	-	-	-	-	-	-	-	-	-	-	-	-	-
CTZ + MTX	-	-	-	-	-	-	-	-	-	-	-	-	-	-
ABT s.c. + MTX	-	-	-	-	-	-	-	-	-	-	-	-	-	-



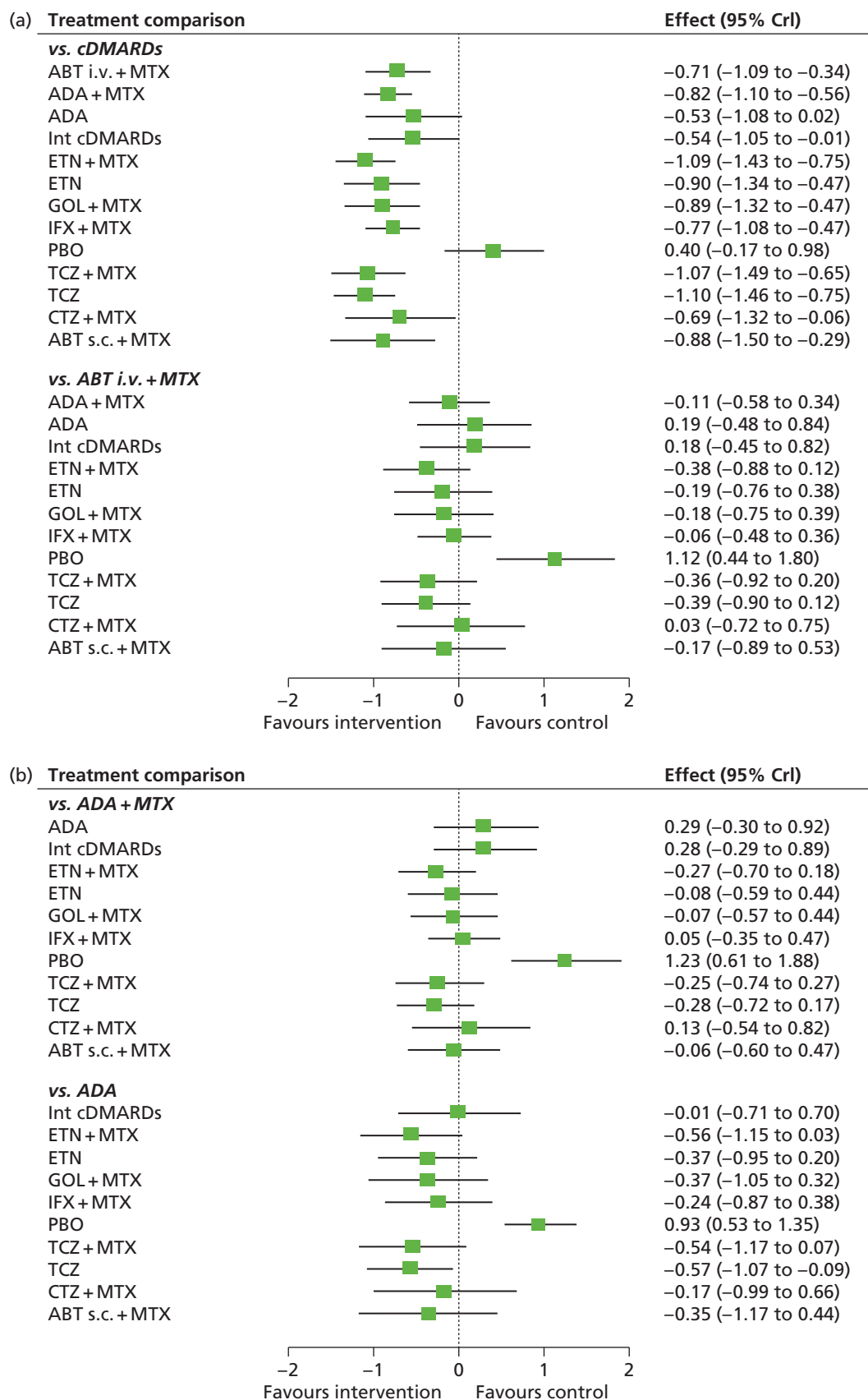


FIGURE 17 American College of Rheumatology (populations 2 and 3: main trials) – effects of interventions relative to cDMARDs on the probit scale. Int, intensive. (continued)

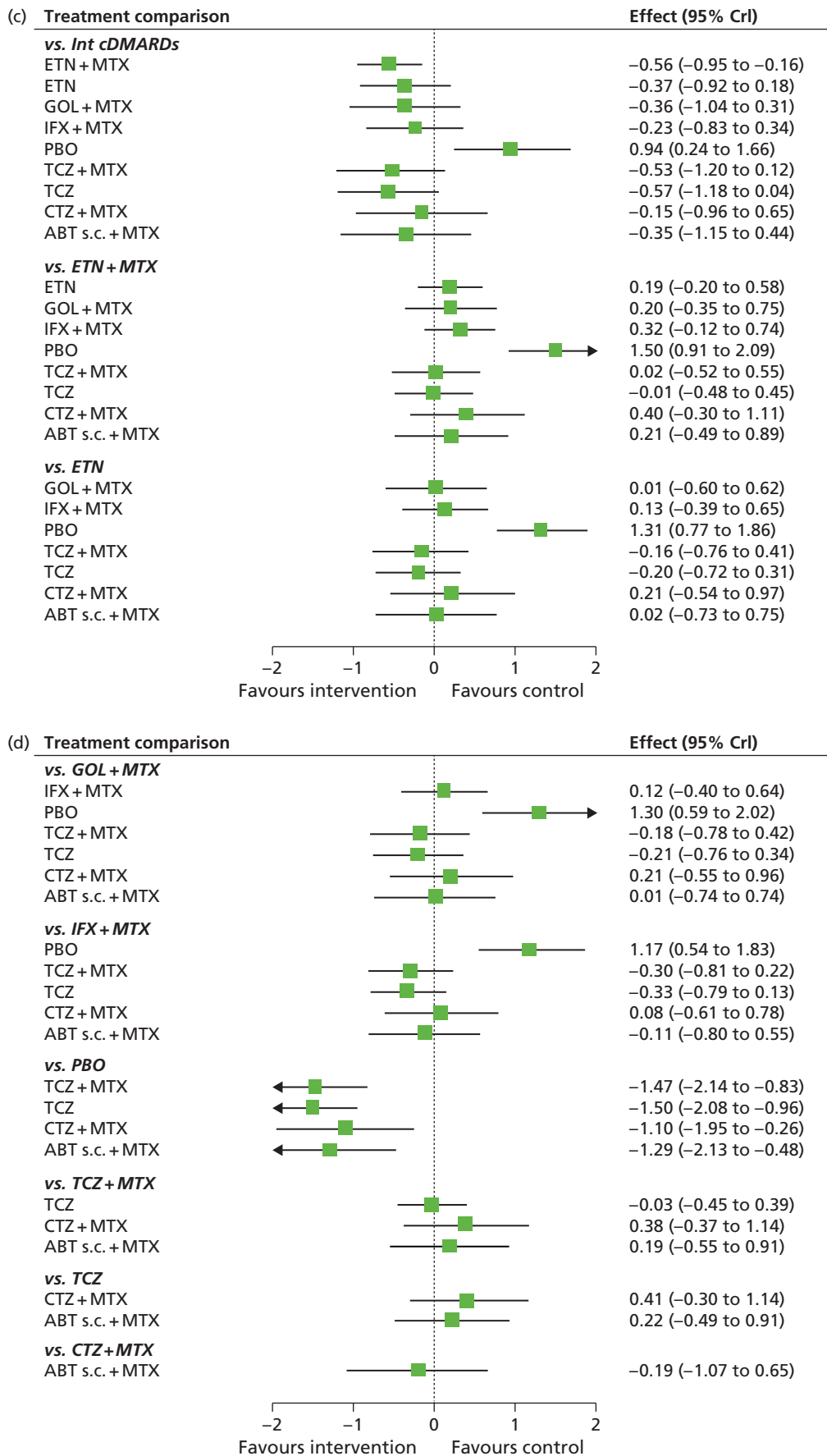
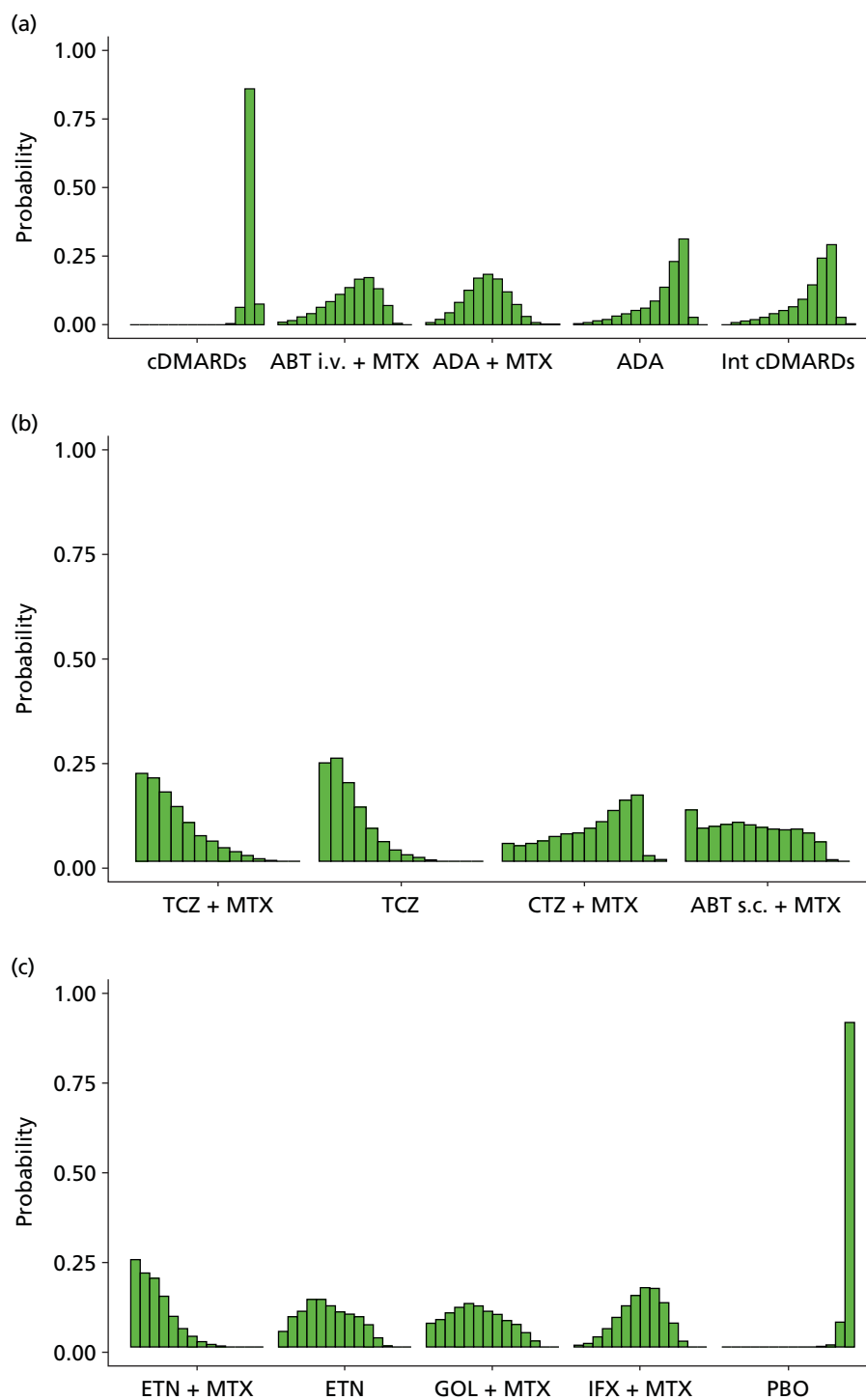


FIGURE 17 American College of Rheumatology (populations 2 and 3: main trials) – effects of interventions relative to cDMARDs on the probit scale. Int, intensive.



**FIGURE 18** American College of Rheumatology (populations 2 and 3: main trials) – probability of treatment rankings in terms of efficacy (most efficacious = 1). Int, intensive.

**TABLE 36** American College of Rheumatology (populations 2 and 3: main trials) – probability of treatment rankings in terms of efficacy (most efficacious = 1)

Intervention	Rank (mean)	Rank													
		1	2	3	4	5	6	7	8	9	10	11	12	13	14
cDMARDs	13.0	0.000	0.000	0.000	0.000	0.000	0.000	0.000	0.000	0.000	0.000	0.004	0.063	0.859	0.075
ABT i.v. + MTX	8.3	0.007	0.014	0.025	0.039	0.062	0.082	0.108	0.131	0.166	0.169	0.130	0.067	0.001	0.000
ADA + MTX	6.8	0.004	0.019	0.040	0.078	0.122	0.168	0.181	0.164	0.117	0.071	0.029	0.006	0.000	0.000
ADA	10.1	0.003	0.005	0.011	0.017	0.029	0.038	0.049	0.058	0.085	0.136	0.230	0.312	0.027	0.000
Intensive cDMARDs	10.0	0.001	0.005	0.010	0.016	0.026	0.037	0.050	0.065	0.090	0.144	0.242	0.291	0.022	0.003
ETN + MTX	3.1	0.247	0.210	0.196	0.144	0.089	0.054	0.031	0.017	0.008	0.003	0.001	0.000	0.000	0.000
ETN	5.7	0.045	0.086	0.103	0.136	0.136	0.118	0.101	0.094	0.086	0.064	0.027	0.005	0.000	0.000
GOL + MTX	5.8	0.067	0.079	0.098	0.113	0.124	0.118	0.103	0.094	0.076	0.065	0.042	0.019	0.000	0.000
IFX + MTX	7.8	0.005	0.013	0.030	0.055	0.084	0.119	0.147	0.168	0.166	0.126	0.069	0.019	0.000	0.000
PBO	13.9	0.000	0.000	0.000	0.000	0.000	0.000	0.000	0.000	0.000	0.000	0.002	0.008	0.071	0.919
TCZ + MTX	3.6	0.213	0.202	0.168	0.133	0.093	0.063	0.049	0.033	0.023	0.015	0.007	0.002	0.000	0.000
TCZ	3.0	0.239	0.251	0.192	0.131	0.080	0.047	0.028	0.017	0.010	0.004	0.001	0.000	0.000	0.000
CTZ + MTX	8.2	0.044	0.037	0.043	0.049	0.060	0.067	0.069	0.081	0.096	0.124	0.149	0.161	0.015	0.003
ABT s.c. + MTX	6.0	0.125	0.081	0.083	0.090	0.095	0.089	0.083	0.079	0.077	0.078	0.069	0.047	0.003	0.001

All interventions except for PBO were associated with beneficial treatment effects relative to cDMARDs with the greatest effects being associated with ETN plus MTX and TCZ (with and without MTX). The treatment effects were statistically significant for all interventions except for ADA and PBO at a conventional 5% level. There was insufficient evidence to differentiate between treatments, although TCZ (mean rank 3.0; probability of being the best 0.234), ETN plus MTX (mean rank 3.1; probability of being the best 0.247) and TCZ plus MTX (mean rank 3.6; probability of being the best 0.213) were the treatments that were most likely to be the most effective interventions.

A meta-analysis was used to estimate the proportion of patients experiencing an ACR 'no response' when treated with cDMARDs.

Data were available from 18 studies.<sup>62,69,70,74–76,79,84,89,91,92,96,99,115–118,121,124,160</sup>

The model fitted the data well, with the total residual deviance, 18.70, close to the total number of data points, 18, included in the analysis.

The between-study SD was estimated to be 0.23 (95% CrI 0.14 to 0.38), which implies mild heterogeneity between studies in the baseline response.

Table 37 presents the probabilities of achieving at least an ACR20, an ACR50 and an ACR70 response. These are derived by combining the treatment effects estimated from the NMA with the estimate of the cDMARDs 'no response' rate.

### American College of Rheumatology: main trials plus prior biologics with AMBITION

A NMA was used to compare the effects of ABT i.v. plus MTX, ADA (with and without MTX), intensive cDMARDs, ETN (with and without MTX), GOL plus MTX, IFX plus MTX, PBO, TCZ (with and without MTX), CTZ plus MTX, ABT s.c. plus MTX, TOF (5-mg and 10-mg doses) and MTX relative to cDMARDs on ACR response.

**TABLE 37** American College of Rheumatology (populations 2 and 3: main trials) – probability of achieving ACR responses

Intervention	At least ACR20 (95% CrI)	At least ACR50 (95% CrI)	At least ACR70 (95% CrI)
cDMARDs	0.298 (0.255 to 0.344)	0.123 (0.098 to 0.1530)	0.042 (0.031 to 0.056)
ABT i.v. + MTX	0.573 (0.418 to 0.719)	0.328 (0.200 to 0.480)	0.156 (0.079 to 0.268)
ADA + MTX	0.615 (0.500 to 0.726)	0.368 (0.263 to 0.489)	0.183 (0.115 to 0.276)
ADA	0.499 (0.286 to 0.712)	0.264 (0.116 to 0.472)	0.115 (0.039 to 0.263)
Intensive cDMARDs	0.503 (0.293 to 0.704)	0.266 (0.120 to 0.462)	0.117 (0.041 to 0.254)
ETN + MTX	0.713 (0.576 to 0.823)	0.472 (0.330 to 0.617)	0.263 (0.157 to 0.394)
ETN	0.645 (0.467 to 0.798)	0.398 (0.237 to 0.580)	0.205 (0.100 to 0.359)
GOL + MTX	0.642 (0.469 to 0.793)	0.395 (0.239 to 0.573)	0.202 (0.101 to 0.351)
IFX + MTX	0.595 (0.466 to 0.718)	0.348 (0.236 to 0.479)	0.169 (0.099 to 0.268)
PBO	0.175 (0.063 to 0.362)	0.059 (0.015 to 0.163)	0.016 (0.003 to 0.061)
TCZ + MTX	0.706 (0.542 to 0.837)	0.464 (0.299 to 0.638)	0.256 (0.136 to 0.415)
TCZ	0.717 (0.578 to 0.830)	0.477 (0.332 to 0.627)	0.266 (0.159 to 0.405)
CTZ + MTX	0.564 (0.314 to 0.785)	0.319 (0.133 to 0.563)	0.150 (0.046 to 0.341)
ABT s.c. + MTX	0.638 (0.400 to 0.837)	0.391 (0.188 to 0.637)	0.199 (0.073 to 0.415)

Data were available from 40 studies comparing two, three or four interventions.<sup>55,57,58,62,66,69,70,74–76,79,80,84,85,89,91,92,96,99,102,105,112,115–118,121,122,124,127,129–138,140,160</sup>

Figure 19 presents the network of evidence and Table 38 presents the frequency with which each pair of treatments was compared. There were 15 treatment effects to estimate from 40 studies.<sup>55,57,58,62,66,69,70,74–76,79,80,84,85,89,91,92,96,99,102,105,112,115–118,121,122,124,127,129–138,140,160</sup>

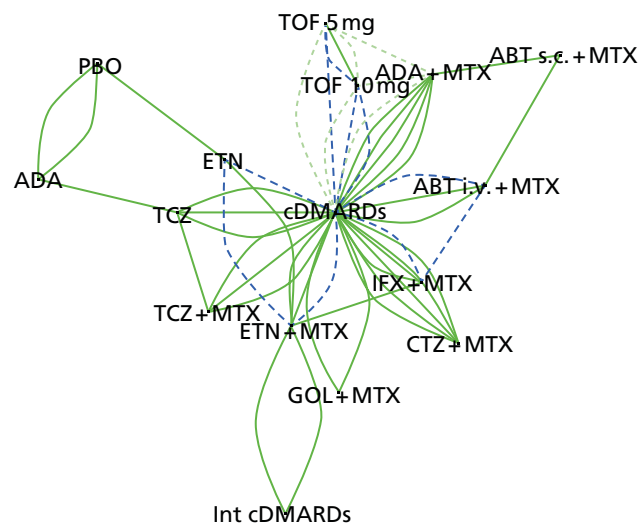
Figure 20 presents the effects of each intervention relative to cDMARDs on the probit scale and Figure 21 and Table 39 present the probabilities of treatment rankings.

There was some suggestion that model was not a good fit to all of the data, with the total residual deviance, 291.84, being larger than the total number of data points, 250, included in the analysis. The largest residual deviances, 14.21 and 14.70, were from Kremer *et al.*,<sup>137</sup> which included patients who received prior biologics, and were from the cDMARDs arm, in which only one patient had an ACR20 response and two patients had an ACR50 response. The next largest residual deviances were 5.92 and 4.04 from the O'Dell *et al.* study<sup>111</sup> and 3.95 from the JESMR study.<sup>140</sup>

The between-study SD was estimated to be 0.21 (95% CrI 0.14 to 0.32), which implies mild heterogeneity between studies in intervention effects. The addition of the AMBITION study<sup>55</sup> and studies in which patients had received prior biologics reduced the point estimate and the uncertainty in the between study SD.

All interventions except for PBO were associated with beneficial treatment effects relative to cDMARDs with the greatest effects being associated with CTZ plus MTX and ETN plus MTX. The treatment effects were statistically significant for all interventions except for ADA and PBO at a conventional 5% level. There was insufficient evidence to differentiate between treatments, although CTZ plus MTX (mean rank 1.9; probability of being the best 0.538) and ETN plus MTX (mean rank 2.9; probability of being the best 0.263) were the treatments that were most likely to be the most effective interventions. The inclusion of the additional studies has had a small impact on six of the treatment effects. However, the effects of ADA (with and without MTX), TCZ (with and without MTX), ABT s.c. plus MTX and PBO were smaller, and the effect of CTZ plus MTX were larger relative to cDMARDs.

A meta-analysis was used to estimate the proportion of patients experiencing an ACR 'no response' when treated with cDMARDs.

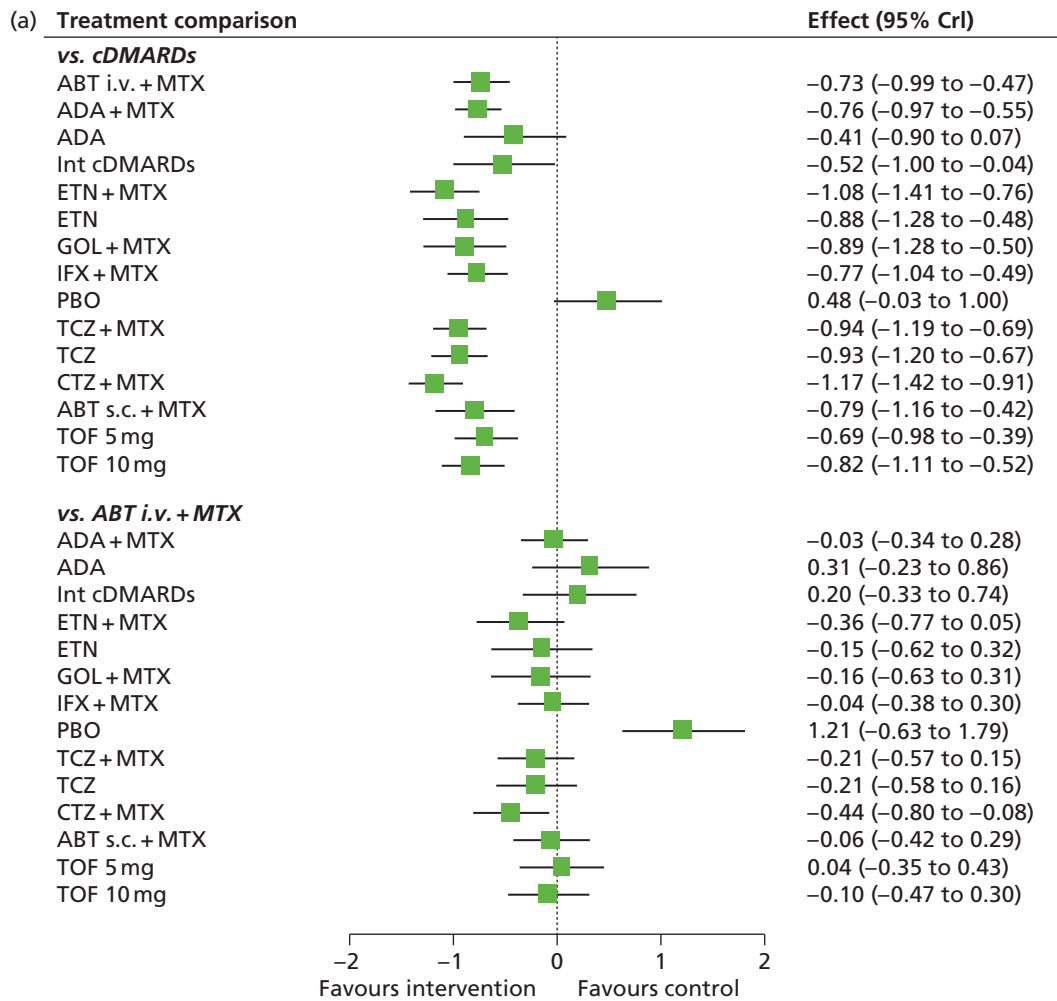


**FIGURE 19** American College of Rheumatology (populations 2 and 3: main trials + prior biologics with AMBITION<sup>55</sup>) – network of evidence. Int, intensive. Solid green line (two-arm study); dotted blue line (three-arm study); and dotted green line (four-arm study).

**TABLE 38** American College of Rheumatology (populations 2 and 3: main trials + prior biologics with AMBITION<sup>55</sup>) – frequency with which each pair of interventions were compared

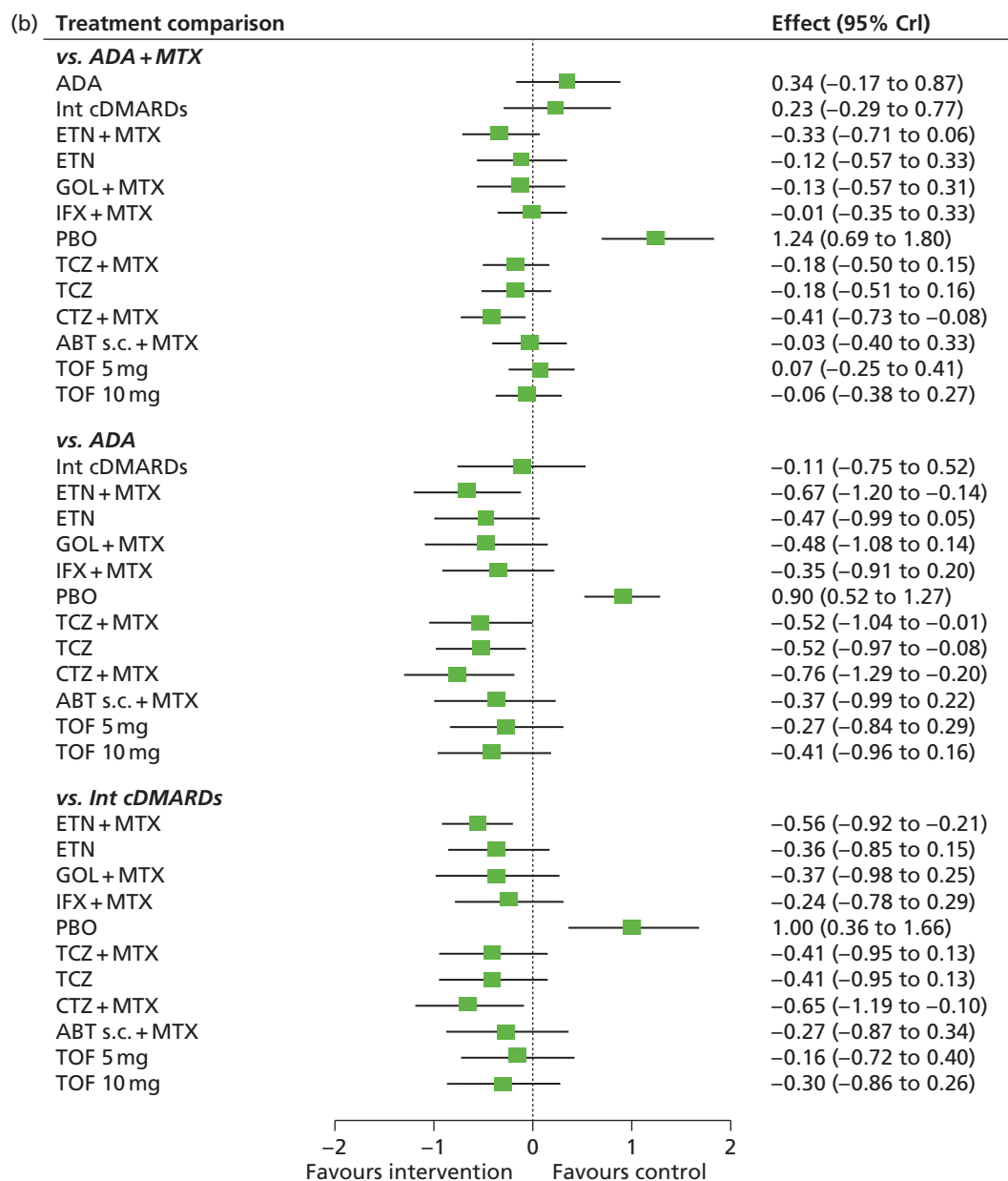
Intervention	cDMARDs	ABT i.v. + MTX	ADA + MTX	ADA + MTX	Intensive cDMARDs	ETN + MTX	ETN	GOL + MTX	IFX + MTX	PBO	TCZ + MTX	TCZ	CTZ + MTX	ABA s.c. + MTX	TOF5 + MTX	TOF10 + MTX
cDMARDs	-	3	6	-	3	1	2	3	3	3	3	3	5	3	3	3
ABT i.v. + MTX	-	-	-	-	-	-	-	1	-	-	-	-	1	1	-	-
ADA + MTX	-	-	-	-	-	-	-	-	-	-	-	-	-	1	1	1
ADA	-	-	-	-	-	-	2	-	-	2	1	-	-	-	-	-
Intensive cDMARDs	-	-	-	-	-	2	-	-	-	-	-	-	-	-	-	-
ETN + MTX	-	-	-	-	-	-	2	1	-	-	-	-	-	-	-	-
ETN	-	-	-	-	-	-	-	-	-	1	-	-	-	-	-	-
GOL + MTX	-	-	-	-	-	-	-	-	-	-	-	-	-	-	-	-
IFX + MTX	-	-	-	-	-	-	-	-	-	-	-	-	-	-	-	-
PBO	-	-	-	-	-	-	-	-	-	-	-	-	-	-	-	-
TCZ + MTX	-	-	-	-	-	-	-	-	-	-	-	1	-	-	-	-
TCZ	-	-	-	-	-	-	-	-	-	-	-	-	-	-	-	-
CTZ + MTX	-	-	-	-	-	-	-	-	-	-	-	-	-	-	-	-
ABT s.c. + MTX	-	-	-	-	-	-	-	-	-	-	-	-	-	-	-	-
TOF5 + MTX	-	-	-	-	-	-	-	-	-	-	-	-	-	-	-	3
TOF10 + MTX	-	-	-	-	-	-	-	-	-	-	-	-	-	-	-	-

TOF5, tofacitinib 5 mg; TOF10, tofacitinib 10 mg.

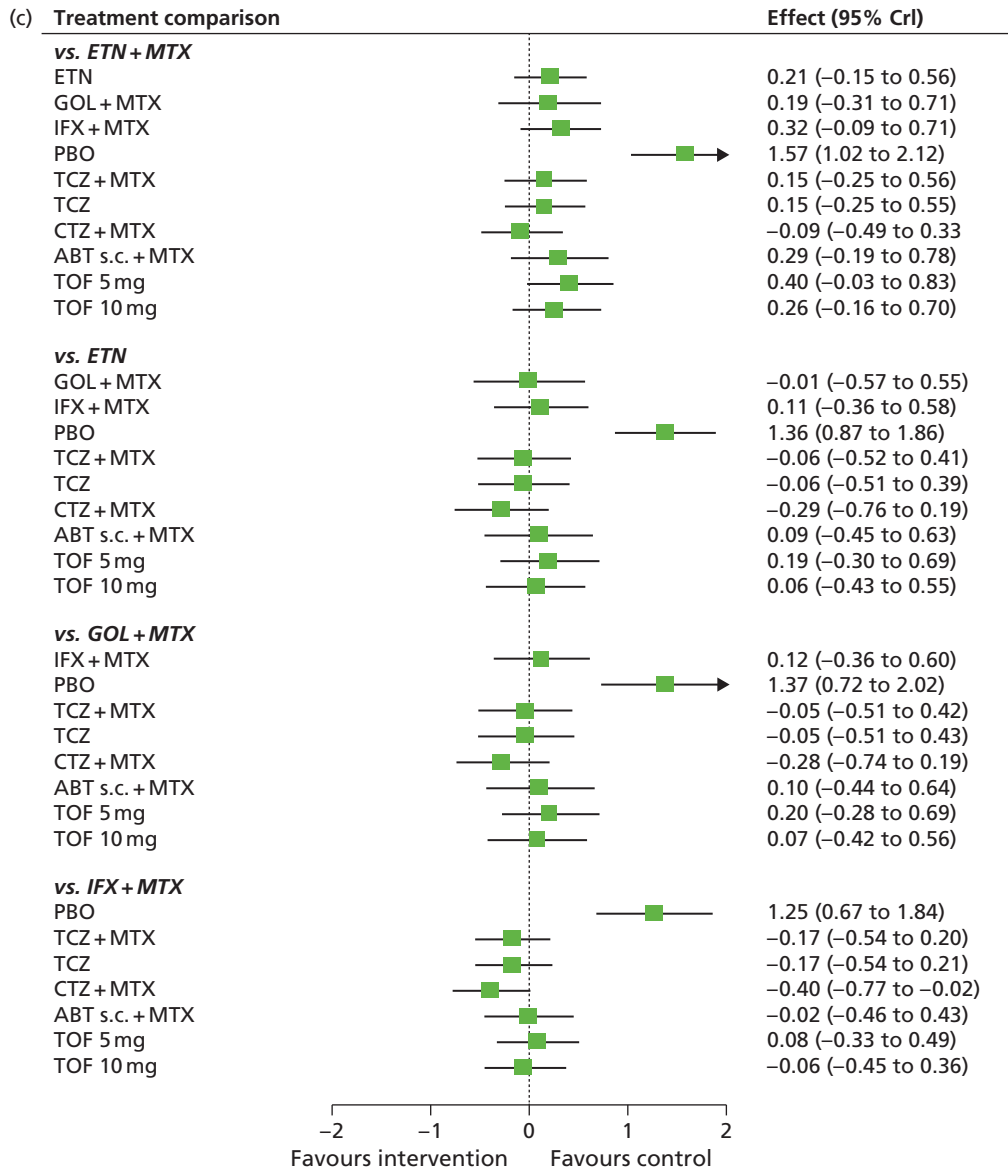


**FIGURE 20** American College of Rheumatology (populations 2 and 3: main trials + prior biologics with AMBITION<sup>55</sup>) – effects of interventions relative to cDMARDs on the probit scale. Int, intensive. (continued)

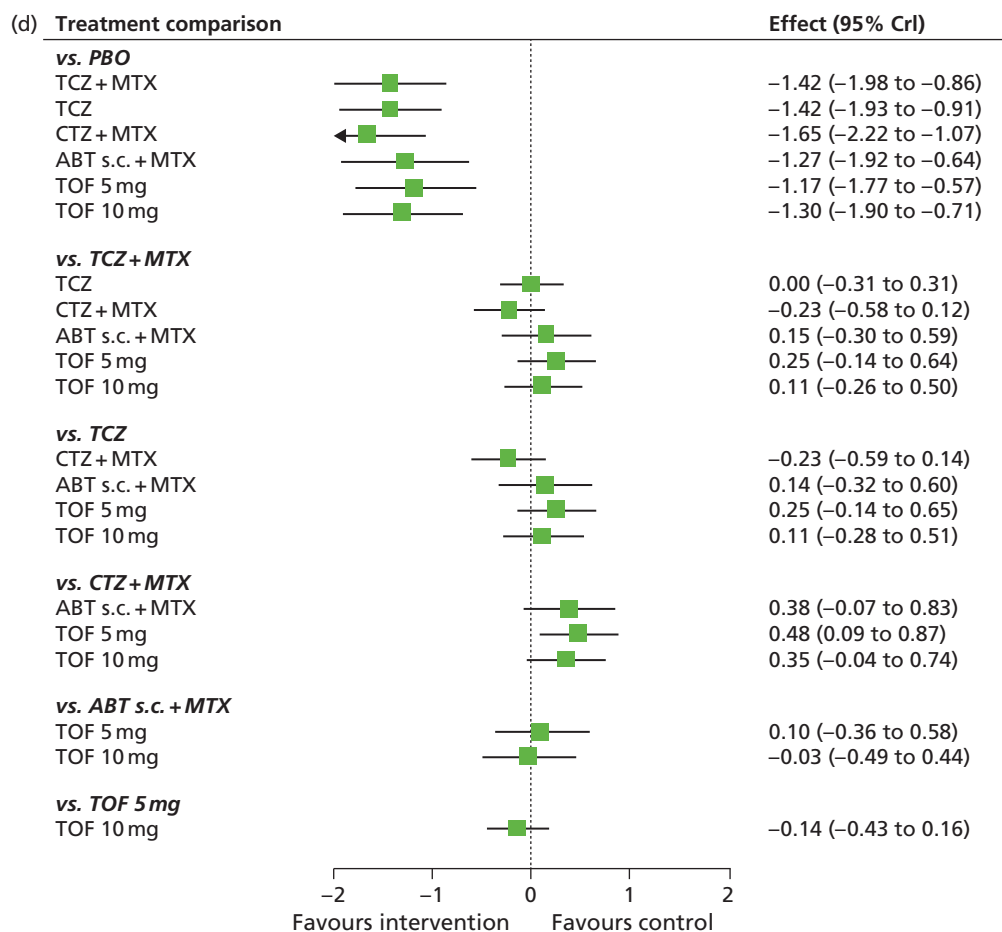




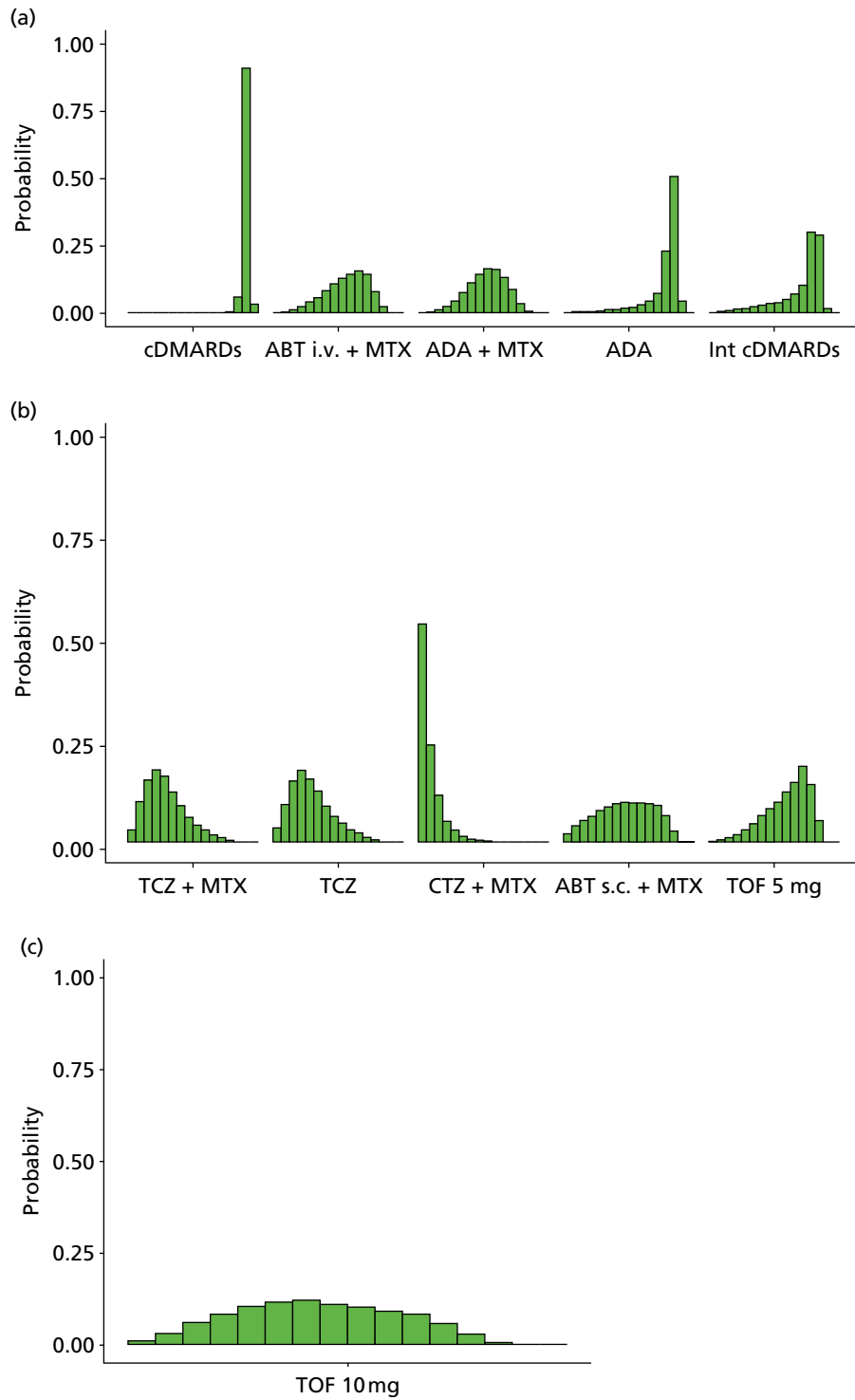
**FIGURE 20** American College of Rheumatology (populations 2 and 3: main trials + prior biologics with AMBITION<sup>55</sup>) – effects of interventions relative to cDMARDs on the probit scale. Int, intensive. (continued)



**FIGURE 20** American College of Rheumatology (populations 2 and 3: main trials + prior biologics with AMBITION<sup>55</sup>) – effects of interventions relative to cDMARDs on the probit scale. Int, intensive. (continued)



**FIGURE 20** American College of Rheumatology (populations 2 and 3: main trials + prior biologics with AMBITION<sup>55</sup>) – effects of interventions relative to cDMARDs on the probit scale. Int, intensive.



**FIGURE 21** American College of Rheumatology (populations 2 and 3: main trials + prior biologics with AMBITION<sup>55</sup>) – probability of treatment rankings in terms of efficacy (most efficacious = 1). Int, intensive.

**TABLE 39** American College of Rheumatology (populations 2 and 3: main trials + prior biologics with AMBITION<sup>55</sup>) – probability of treatment rankings in terms of efficacy (most efficacious = 1)

Intervention	Rank																
	Rank (mean)	1	2	3	4	5	6	7	8	9	10	11	12	13	14	15	16
cDMARDs	15.0	0.000	0.000	0.000	0.000	0.000	0.000	0.000	0.000	0.000	0.000	0.000	0.000	0.002	0.058	0.909	0.032
ABT i.v. + MTX	9.5	0.001	0.004	0.013	0.024	0.039	0.057	0.082	0.107	0.129	0.144	0.154	0.145	0.078	0.023	0.000	0.000
ADA + MTX	8.9	0.001	0.004	0.010	0.023	0.043	0.076	0.112	0.143	0.165	0.162	0.132	0.088	0.035	0.006	0.000	0.000
ADA	12.9	0.001	0.001	0.003	0.004	0.007	0.010	0.013	0.018	0.021	0.030	0.044	0.073	0.228	0.505	0.043	0.000
Intensive cDMARDs	11.8	0.000	0.004	0.009	0.014	0.018	0.022	0.030	0.035	0.039	0.051	0.070	0.104	0.299	0.288	0.016	0.001
ETN + MTX	2.9	0.263	0.295	0.165	0.103	0.067	0.042	0.026	0.017	0.011	0.006	0.004	0.001	0.000	0.000	0.000	0.000
ETN	6.4	0.037	0.077	0.122	0.110	0.104	0.098	0.088	0.075	0.067	0.061	0.060	0.072	0.026	0.004	0.000	0.000
GOL + MTX	6.3	0.063	0.096	0.107	0.105	0.102	0.096	0.083	0.070	0.064	0.056	0.056	0.054	0.035	0.014	0.000	0.000
IFX + MTX	8.6	0.003	0.011	0.029	0.049	0.066	0.091	0.105	0.117	0.120	0.116	0.115	0.106	0.056	0.016	0.000	0.000
PBO	16.0	0.000	0.000	0.000	0.000	0.000	0.000	0.000	0.000	0.000	0.000	0.000	0.000	0.000	0.001	0.032	0.967
TCZ + MTX	5.1	0.030	0.100	0.153	0.179	0.162	0.123	0.089	0.061	0.041	0.030	0.018	0.010	0.003	0.001	0.000	0.000
TCZ	5.2	0.033	0.093	0.152	0.176	0.154	0.126	0.088	0.064	0.046	0.030	0.022	0.012	0.004	0.000	0.000	0.000
CTZ + MTX	1.9	0.538	0.239	0.115	0.051	0.029	0.014	0.007	0.004	0.002	0.001	0.001	0.000	0.000	0.000	0.000	0.000
ABT s.c. + MTX	8.0	0.020	0.040	0.054	0.063	0.076	0.086	0.094	0.098	0.096	0.097	0.094	0.090	0.065	0.027	0.000	0.000
TOF5 + MTX	10.2	0.001	0.004	0.009	0.017	0.029	0.045	0.064	0.082	0.097	0.123	0.147	0.187	0.142	0.053	0.000	0.000
TOF10 + MTX	7.4	0.010	0.032	0.060	0.083	0.103	0.115	0.120	0.110	0.102	0.091	0.083	0.058	0.027	0.006	0.000	0.000
TOF5, tofacitinib 5 mg; TOF10, tofacitinib 10 mg.																	

Data were available from 29 studies.<sup>55,62,69,70,74–76,79,84,89,91,92,96,99,115–118,121,124,128–138,160</sup>

The model fitted the data well, with the total residual deviance, 29.14, close to the total number of data points, 29, included in the analysis.

The between-study SD was estimated to be 0.27 (95% CrI 0.19 to 0.38), which implies mild heterogeneity between studies in the baseline response.

Table 40 presents the probabilities of achieving at least an ACR20, an ACR50 and an ACR70 response. These are derived by combining the treatment effects estimated from the NMA with the estimate of the cDMARDs 'no response' rate.

### American College of Rheumatology: main trials plus prior biologics without AMBITION

A NMA was used to compare the effects of ABT i.v. plus MTX, ADA (with and without MTX), intensive cDMARDs, ETN (with and without MTX), GOL plus MTX, IFX plus MTX, PBO, TCZ (with and without MTX), CTZ plus MTX, ABT s.c. plus MTX and TOF plus MTX (5-mg and 10-mg doses) relative to cDMARDs on ACR response.

Data were available from 39 studies comparing two, three or four interventions.<sup>57,58,62,66,69,70,74–76,79,80,84,85,89,91,92,96,99,102,105,112,115–118,121,122,124,127,129–138,140,160</sup>

**TABLE 40** American College of Rheumatology (populations 2 and 3: main trials + prior biologics with AMBITION<sup>55</sup>) – probability of achieving ACR responses

Intervention	At least ACR20 (95% CrI)	At least ACR50 (95% CrI)	At least ACR70 (95% CrI)
cDMARDs	0.279 (0.242 to 0.318)	0.117 (0.095 to 0.142)	0.038 (0.029 to 0.049)
ABT i.v. + MTX	0.556 (0.444 to 0.664)	0.321 (0.228 to 0.428)	0.148 (0.092 to 0.223)
ADA + MTX	0.568 (0.475 to 0.659)	0.332 (0.252 to 0.424)	0.155 (0.106 to 0.220)
ADA	0.432 (0.253 to 0.625)	0.219 (0.102 to 0.387)	0.088 (0.032 to 0.194)
Intensive cDMARDs	0.475 (0.290 to 0.667)	0.253 (0.123 to 0.432)	0.106 (0.041 to 0.226)
ETN + MTX	0.690 (0.563 to 0.800)	0.457 (0.328 to 0.593)	0.246 (0.152 to 0.365)
ETN	0.616 (0.452 to 0.761)	0.378 (0.233 to 0.542)	0.187 (0.095 to 0.317)
GOL + MTX	0.619 (0.460 to 0.759)	0.381 (0.240 to 0.540)	0.189 (0.099 to 0.316)
IFX + MTX	0.572 (0.453 to 0.683)	0.336 (0.234 to 0.451)	0.158 (0.096 to 0.241)
PBO	0.143 (0.054 to 0.293)	0.047 (0.014 to 0.126)	0.012 (0.003 to 0.042)
TCZ + MTX	0.637 (0.532 to 0.734)	0.400 (0.299 to 0.508)	0.202 (0.134 to 0.288)
TCZ	0.636 (0.524 to 0.758)	0.399 (0.292 to 0.513)	0.201 (0.130 to 0.292)
CTZ + MTX	0.721 (0.620 to 0.804)	0.492 (0.381 to 0.599)	0.274 (0.189 to 0.371)
ABT s.c. + MTX	0.580 (0.428 to 0.723)	0.344 (0.215 to 0.496)	0.163 (0.085 to 0.278)
TOF5 + MTX	0.541 (0.413 to 0.660)	0.308 (0.204 to 0.425)	0.139 (0.080 to 0.220)
TOF10 + MTX	0.593 (0.469 to 0.708)	0.356 (0.246 to 0.478)	0.171 (0.103 to 0.262)

TOF5, tofacitinib 5 mg; TOF10, tofacitinib 10 mg.

Figure 22 presents the network of evidence and Table 41 presents the frequency with which each pair of treatments was compared. There were 15 treatment effects to estimate from 39 studies.

Figure 23 presents the effects of each intervention relative to cDMARDs on the probit scale and Figure 24 and Table 42 present the probabilities of treatment rankings.

There was some suggestion that model was not a good fit to all of the data, with the total residual deviance, 281.87, being larger than the total number of data points, 244, included in the analysis. The largest residual deviances, 14.8 and 14.21, were from the Kramer *et al.* study,<sup>137</sup> which included patients who received prior biologics, and were from the cDMARDs arm, in which only one patient had an ACR20 response and two patients had an ACR50 response. The next largest residual deviances were 5.76 and 4.23 from the O'Dell *et al.* study,<sup>111</sup> 4.08 from the JESMR study<sup>140</sup> and 3.86 from the ARMADA study.<sup>69</sup>

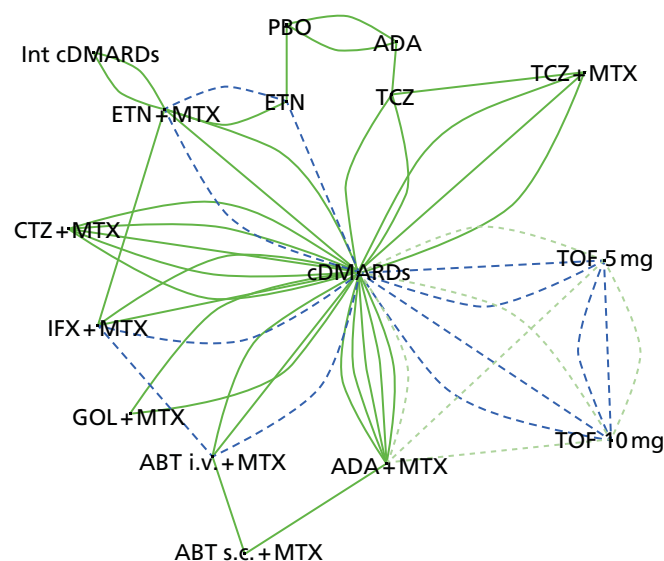
The between-study SD was estimated to be 0.20 (95% CrI 0.12 to 0.31), which implies mild heterogeneity between studies in intervention effects. The exclusion of the AMBITION study<sup>55</sup> had little impact on the estimate of the between-study SD from studies including patients who had received prior biologics.

All interventions except for PBO were associated with beneficial treatment effects relative to cDMARDs, with the greatest effects being associated with CTZ plus MTX, ETN plus MTX and TCZ. The treatment effects were statistically significant for all interventions except for PBO at a conventional 5% level. There was insufficient evidence to differentiate between treatments, although CTZ plus MTX (mean rank 2.1; probability of being the best 0.459) and ETN plus MTX (mean rank 3.0; probability of being the best 0.246) were the treatments that were most likely to be the most effective interventions. The exclusion of the AMBITION study<sup>55</sup> has increased the treatment effects for ADA and TCZ (with and without MTX) back towards the effects estimated from the main studies alone, but shrunk the effect of ABT s.c. plus MTX.

A meta-analysis was used to estimate the proportion of patients experiencing an ACR 'no response' when treated with cDMARDs.

Data were available from 28 studies.<sup>62,69,70,74–76,79,84,89,91,92,96,99,115–118,121,124,129–138,160</sup>

The model fitted the data well, with the total residual deviance, 28.26, close to the total number of data points, 28, included in the analysis.

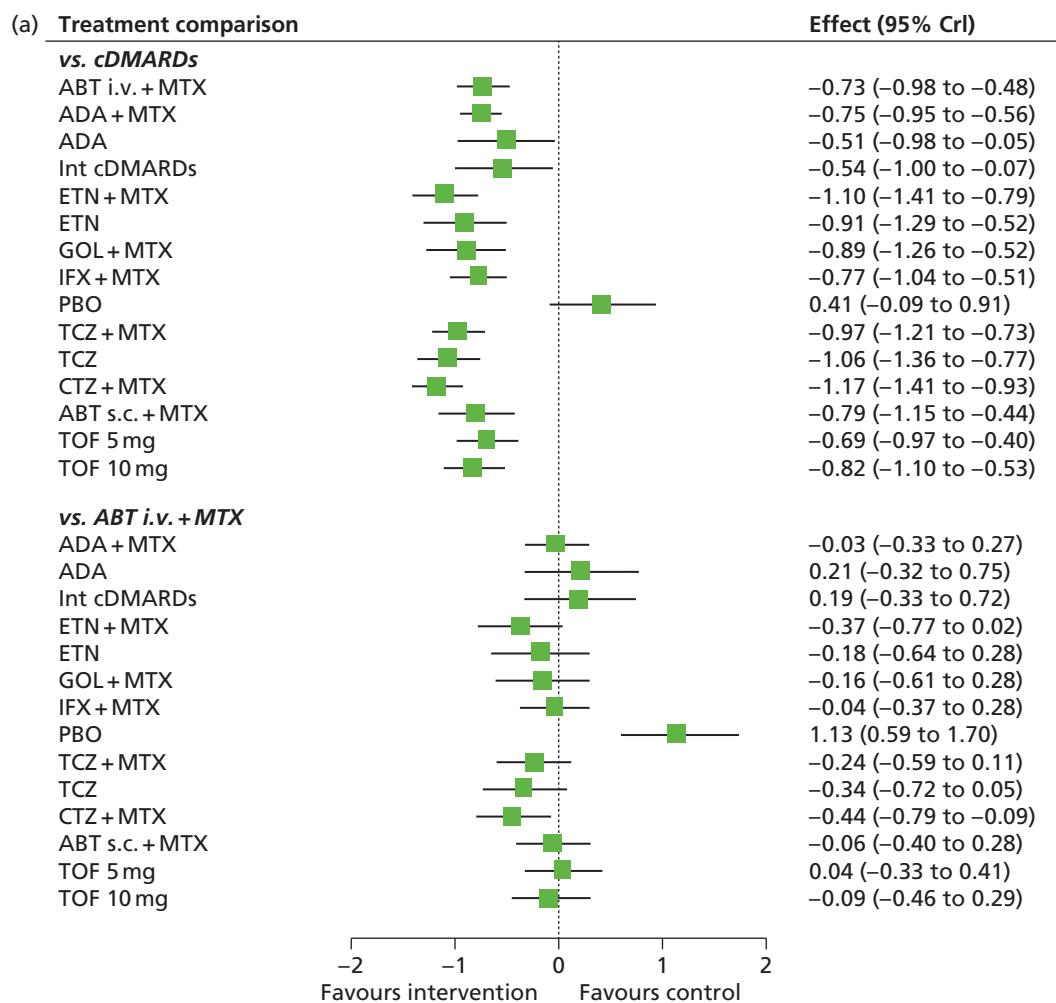


**FIGURE 22** American College of Rheumatology (populations 2 and 3: main trials + prior biologics without AMBITION<sup>55</sup>) – network of evidence. Int, intensive. Solid green line (two-arm study); and dotted blue line (three-arm study).

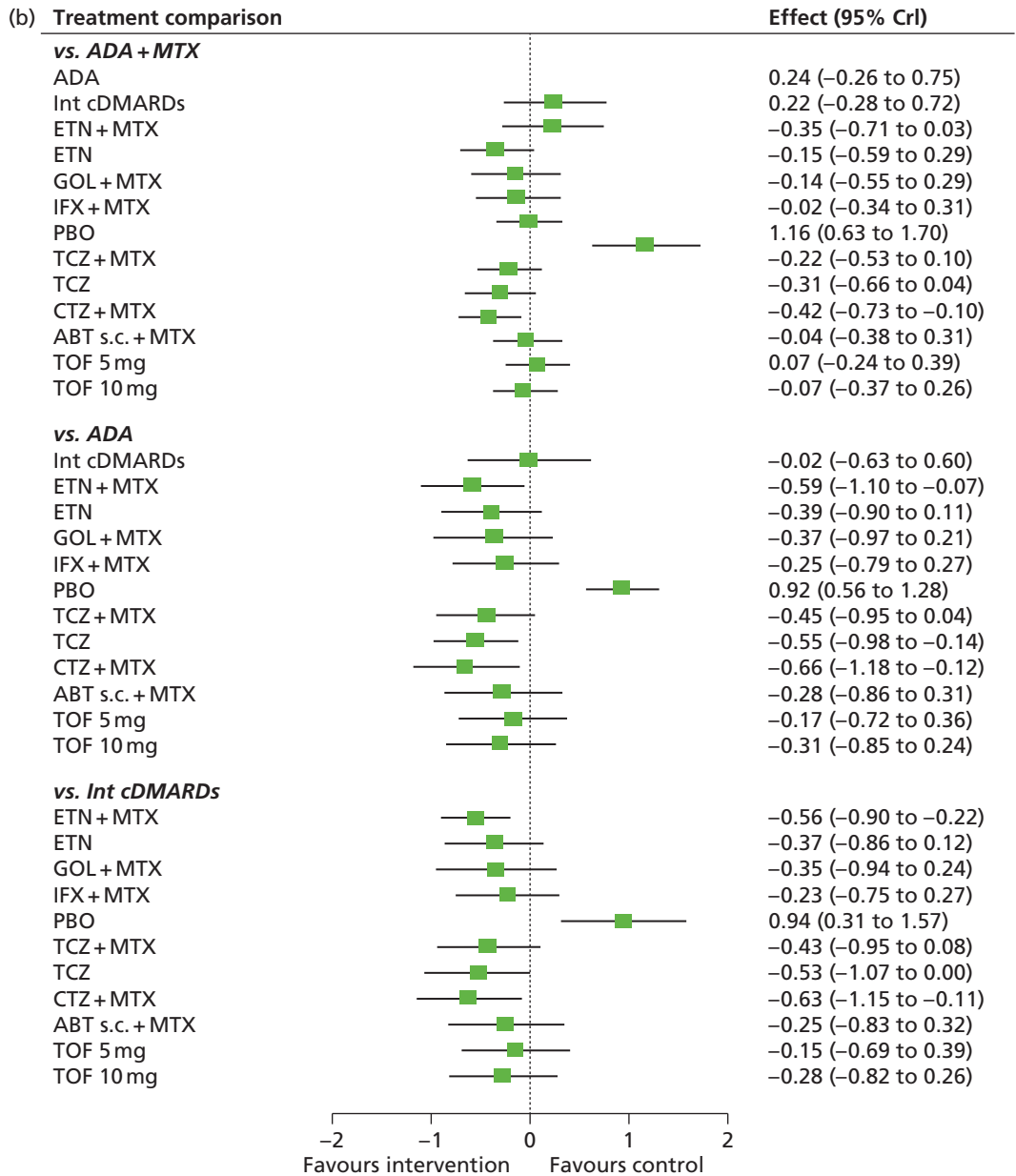
**TABLE 41** American College of Rheumatology (populations 2 and 3: main trials + prior biologics without AMBITION<sup>65</sup>) – frequency with which each pair of interventions were compared

Intervention	cDMARDs	ABT i.v. + MTX	ADA + MTX	ADA	Intensive cDMARDs	Intensive	ETN + MTX	ETN	GOL + MTX	IFX + MTX	PBO	TCZ + MTX	TCZ	CTZ + MTX	ABT s.c. + MTX	TOF5 + MTX	TOF10 + MTX
cDMARDs	-	3	6	-	-	3	1	2	3	3	3	2	5	3	3	3	3
ABT i.v. + MTX	-	-	-	-	-	-	1	-	1	-	-	-	-	1	-	-	-
ADA + MTX	-	-	-	-	-	-	-	-	-	-	-	-	-	1	1	1	1
ADA	-	-	-	-	-	-	-	2	-	2	1	-	-	-	-	-	-
Intensive cDMARDs	-	-	-	-	-	2	-	-	-	-	-	-	-	-	-	-	-
ETN + MTX	-	-	-	-	-	-	2	-	1	-	-	-	-	-	-	-	-
ETN	-	-	-	-	-	-	-	-	-	1	-	-	-	-	-	-	-
GOL + MTX	-	-	-	-	-	-	-	-	-	-	-	-	-	-	-	-	-
IFX + MTX	-	-	-	-	-	-	-	-	-	-	-	-	-	-	-	-	-
PBO	-	-	-	-	-	-	-	-	-	-	-	-	-	-	-	-	-
TCZ + MTX	-	-	-	-	-	-	-	-	-	-	-	1	-	-	-	-	-
TCZ	-	-	-	-	-	-	-	-	-	-	-	-	-	-	-	-	-
CTZ + MTX	-	-	-	-	-	-	-	-	-	-	-	-	-	-	-	-	-
ABT s.c. + MTX	-	-	-	-	-	-	-	-	-	-	-	-	-	-	-	-	-
TOF5 + MTX	-	-	-	-	-	-	-	-	-	-	-	-	-	-	-	-	3
TOF10 + MTX	-	-	-	-	-	-	-	-	-	-	-	-	-	-	-	-	-

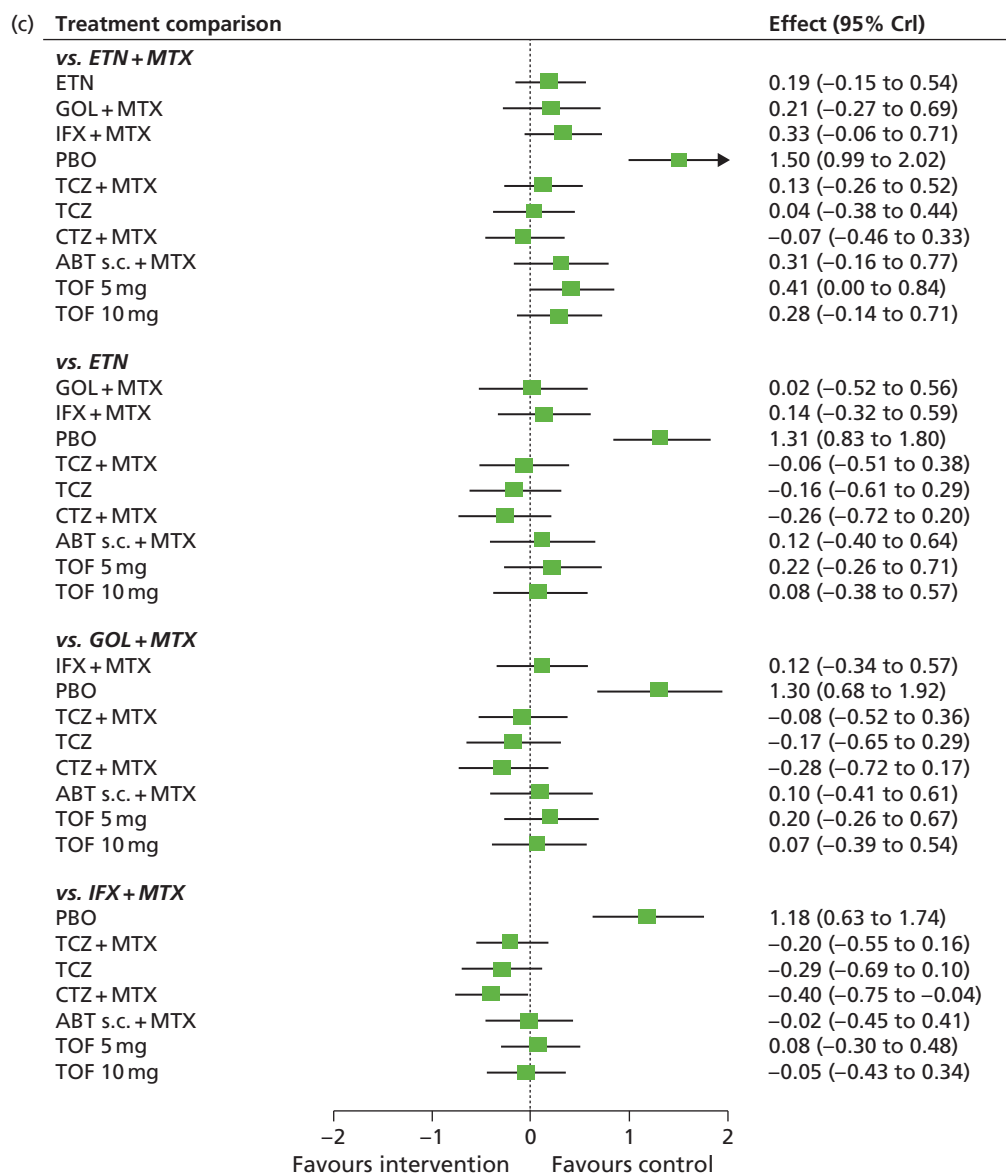




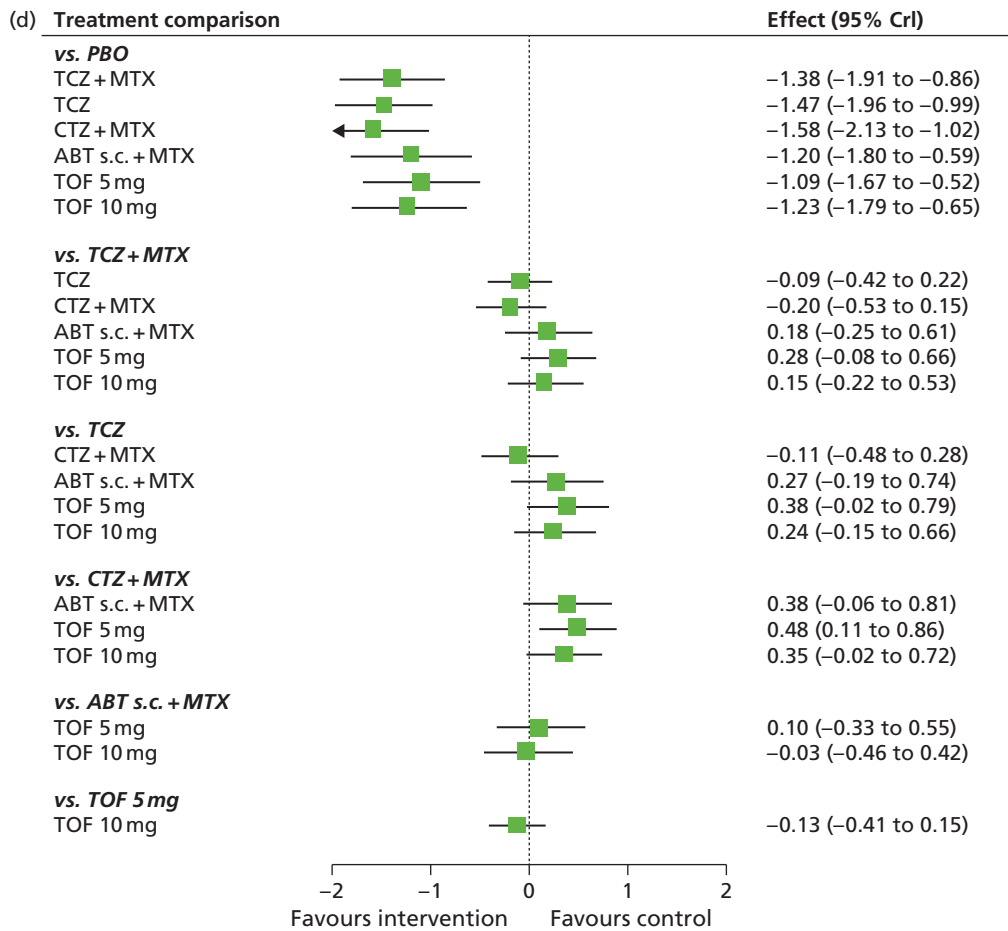
**FIGURE 23** American College of Rheumatology (populations 2 and 3: main trials + prior biologics without AMBITION<sup>55</sup>) – effects of interventions relative to cDMARDs on the probit scale. Int, intensive. (*continued*)



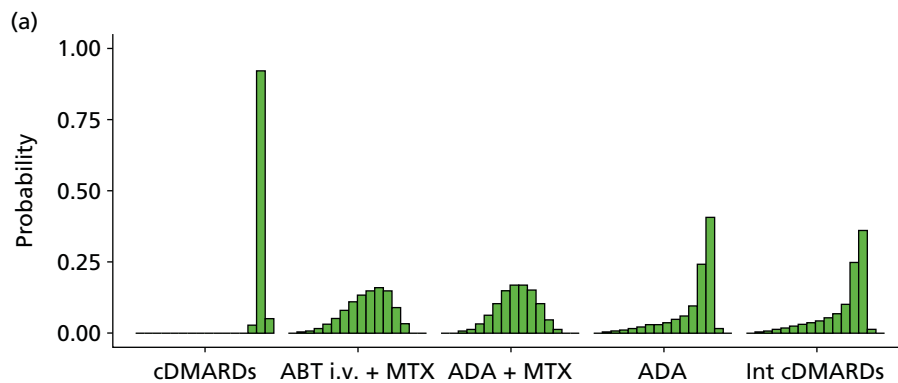
**FIGURE 23** American College of Rheumatology (populations 2 and 3: main trials + prior biologics without AMBITION<sup>55</sup>) – effects of interventions relative to cDMARDs on the probit scale. Int, intensive. (continued)



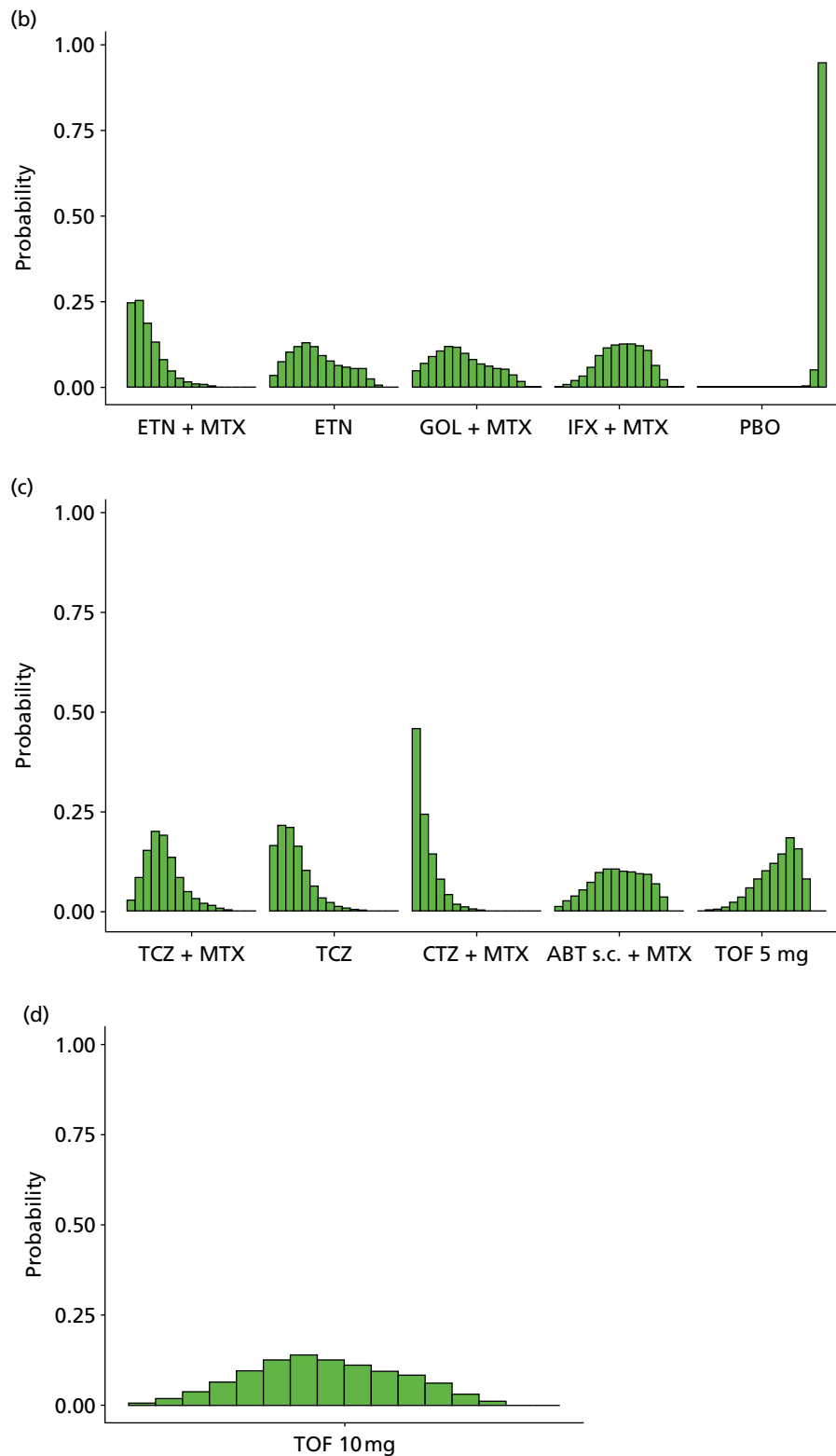
**FIGURE 23** American College of Rheumatology (populations 2 and 3: main trials + prior biologics without AMBITION<sup>55</sup>) – effects of interventions relative to cDMARDs on the probit scale. Int, intensive. (*continued*)



**FIGURE 23** American College of Rheumatology (populations 2 and 3: main trials + prior biologics without AMBITION<sup>55</sup>) – effects of interventions relative to cDMARDs on the probit scale. Int, intensive.



**FIGURE 24** American College of Rheumatology (populations 2 and 3: main trials + prior biologics without AMBITION<sup>55</sup>) – probability of treatment rankings in terms of efficacy (most efficacious = 1). Int, intensive. (continued)



**FIGURE 24** American College of Rheumatology (populations 2 and 3: main trials + prior biologics without AMBITION<sup>55</sup>) – probability of treatment rankings in terms of efficacy (most efficacious = 1). Int, intensive.

**TABLE 42** American College of Rheumatology (populations 2 and 3: main trials + prior biologics without AMBITION<sup>5</sup>) – probability of treatment rankings in terms of efficacy (most efficacious = 1)

Intervention	Rank (mean)	Rank																		
		1	2	3	4	5	6	7	8	9	10	11	12	13	14	15	16			
cDMARDs	15.0	0.000	0.000	0.000	0.000	0.000	0.000	0.000	0.000	0.000	0.000	0.000	0.000	0.000	0.001	0.027	0.921	0.051		
ABT i.v. + MTX	9.7	0.000	0.002	0.007	0.015	0.030	0.051	0.079	0.109	0.133	0.146	0.158	0.148	0.148	0.089	0.032	0.000	0.000	0.000	
ADA + MTX	9.2	0.000	0.001	0.005	0.013	0.031	0.061	0.103	0.146	0.167	0.168	0.148	0.102	0.045	0.011	0.000	0.000	0.000	0.000	
ADA	12.2	0.001	0.002	0.004	0.007	0.013	0.020	0.028	0.030	0.036	0.046	0.058	0.093	0.241	0.405	0.016	0.000	0.000	0.000	
Intensive cDMARDs	12.0	0.001	0.003	0.005	0.010	0.017	0.024	0.030	0.035	0.042	0.051	0.067	0.099	0.245	0.358	0.013	0.001	0.001	0.001	
ETN + MTX	3.0	0.246	0.253	0.187	0.130	0.080	0.047	0.025	0.013	0.009	0.007	0.003	0.001	0.000	0.000	0.000	0.000	0.000	0.000	
ETN	6.3	0.035	0.073	0.102	0.118	0.130	0.118	0.092	0.076	0.063	0.058	0.054	0.054	0.023	0.004	0.000	0.000	0.000	0.000	
GOL + MTX	6.6	0.046	0.068	0.088	0.104	0.117	0.115	0.098	0.080	0.068	0.060	0.053	0.051	0.035	0.016	0.000	0.000	0.000	0.000	
IFX + MTX	8.9	0.001	0.006	0.017	0.032	0.058	0.091	0.113	0.122	0.124	0.125	0.120	0.108	0.062	0.020	0.000	0.000	0.000	0.000	
PBO	16.0	0.000	0.000	0.000	0.000	0.000	0.000	0.000	0.000	0.000	0.000	0.000	0.000	0.000	0.002	0.050	0.948	0.000	0.000	
TCZ + MTX	4.9	0.028	0.085	0.154	0.200	0.191	0.136	0.084	0.049	0.031	0.019	0.013	0.007	0.002	0.000	0.000	0.000	0.000	0.000	
TCZ	3.4	0.164	0.216	0.209	0.163	0.102	0.062	0.034	0.022	0.013	0.008	0.004	0.002	0.001	0.000	0.000	0.000	0.000	0.000	
CTZ + MTX	2.1	0.459	0.243	0.143	0.080	0.041	0.017	0.010	0.003	0.001	0.001	0.001	0.000	0.000	0.000	0.000	0.000	0.000	0.000	
ABT s.c. + MTX	8.3	0.012	0.026	0.037	0.054	0.073	0.096	0.106	0.107	0.100	0.097	0.095	0.093	0.068	0.036	0.000	0.000	0.000	0.000	
TOF5 + MTX	10.5	0.000	0.002	0.004	0.011	0.021	0.036	0.060	0.081	0.101	0.120	0.144	0.184	0.156	0.080	0.000	0.000	0.000	0.000	0.000
TOF10 + MTX	7.7	0.006	0.019	0.038	0.064	0.095	0.125	0.139	0.125	0.111	0.094	0.083	0.060	0.031	0.010	0.000	0.000	0.000	0.000	

The between-study SD was estimated to be 0.26 (95% CrI 0.18 to 0.37), which implies mild heterogeneity between studies in the baseline response.

Table 43 presents the probabilities of achieving at least an ACR20, ACR50 and an ACR70 response. These are derived by combining the treatment effects estimated from the NMA with the estimate of the cDMARDs 'no response' rate.

### American College of Rheumatology: main trials plus randomised controlled trials that have potentially low prior methotrexate exposure

A NMA was used to compare the effects of ABT i.v. plus MTX, ADA (with and without MTX), intensive cDMARDs, ETN (with and without MTX), GOL plus MTX, IFX plus MTX, PBO, TCZ (with and without MTX), CTZ plus MTX and ABT s.c. plus MTX relative to cDMARDs on ACR response.

Data were available from 30 studies comparing two or three interventions.<sup>53,54,57,58,62,66,69,70,74–76,79,80,84,85,89,91,92,96,99,102,105,112,115–118,121,122,124,140,160</sup>

**TABLE 43** American College of Rheumatology (populations 2 and 3: main trials + prior biologics without AMBITION<sup>55</sup>) – probability of achieving ACR responses

Intervention	At least ACR20 (95% CrI)	At least ACR50 (95% CrI)	At least ACR70 (95% CrI)
cDMARDs	0.273 (0.238 to 0.311)	0.114 (0.093 to 0.138)	0.037 (0.028 to 0.047)
ABT i.v. + MTX	0.550 (0.442 to 0.657)	0.316 (0.226 to 0.421)	0.144 (0.090 to 0.217)
ADA + MTX	0.560 (0.472 to 0.648)	0.325 (0.249 to 0.411)	0.150 (0.103 to 0.209)
ADA	0.465 (0.284 to 0.651)	0.244 (0.121 to 0.415)	0.101 (0.039 to 0.212)
Intensive cDMARDs	0.473 (0.293 to 0.658)	0.251 (0.125 to 0.422)	0.105 (0.041 to 0.217)
ETN + MTX	0.689 (0.567 to 0.797)	0.457 (0.331 to 0.589)	0.244 (0.153 to 0.360)
ETN	0.619 (0.460 to 0.758)	0.382 (0.241 to 0.539)	0.188 (0.098 to 0.314)
GOL + MTX	0.613 (0.461 to 0.748)	0.375 (0.241 to 0.527)	0.183 (0.098 to 0.303)
IFX + MTX	0.566 (0.453 to 0.675)	0.331 (0.235 to 0.442)	0.153 (0.095 to 0.232)
PBO	0.156 (0.064 to 0.307)	0.053 (0.017 to 0.134)	0.014 (0.003 to 0.046)
TCZ + MTX	0.643 (0.541 to 0.736)	0.406 (0.308 to 0.512)	0.205 (0.139 to 0.290)
TCZ	0.678 (0.561 to 0.781)	0.443 (0.325 to 0.569)	0.233 (0.150 to 0.340)
CTZ + MTX	0.714 (0.618 to 0.798)	0.485 (0.380 to 0.591)	0.267 (0.186 to 0.362)
ABT s.c. + MTX	0.574 (0.428 to 0.713)	0.338 (0.215 to 0.484)	0.158 (0.085 to 0.266)
TOF5 + MTX	0.534 (0.412 to 0.649)	0.302 (0.204 to 0.413)	0.135 (0.079 to 0.211)
TOF10 + MTX	0.586 (0.465 to 0.697)	0.350 (0.243 to 0.466)	0.166 (0.100 to 0.251)

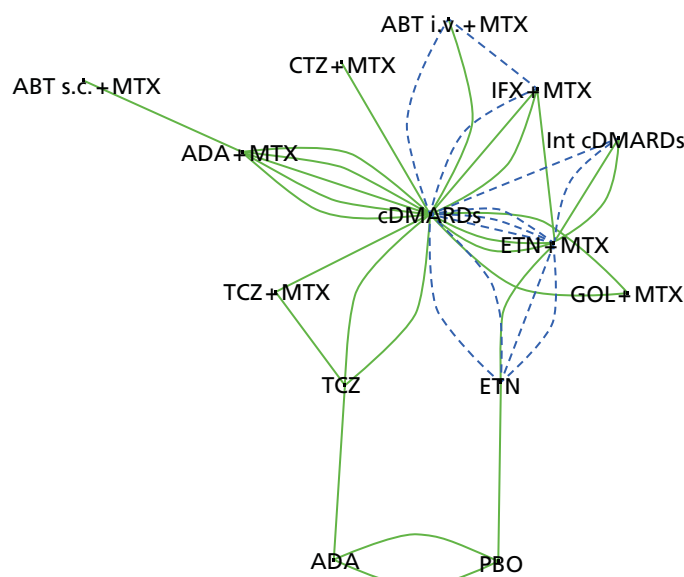
Figure 25 presents the network of evidence and Table 44 presents the frequency with which each pair of treatments was compared. There were 13 treatment effects to estimate from 30 studies.<sup>53,54,57,58,62,66,69,70,74–76,79,80,84,85,89,91,92,96,99,102,105,112,115–118,121,122,124,140,160</sup>

Figure 26 presents the effects of each intervention relative to cDMARDs on the probit scale and Figure 27 and Table 45 present the probabilities of treatment rankings.

The model fitted the data well, with the total residual deviance, 198.62, close to the total number of data points, 192, included in the analysis. The largest residual deviances were 5.999 from the O'Dell *et al.* study<sup>111</sup> and 3.913 from the Safety Trial for rheumatoid Arthritis with Remicade Therapy (START) study.<sup>118</sup>

The between-study SD was estimated to be 0.30 (95% CrI 0.20 to 0.46), which implies mild heterogeneity between studies in intervention effects. The addition of the TEAR<sup>53</sup> and TEMPO<sup>54</sup> studies has increased the variability between treatment effects relative to that estimated from the main studies alone.

All interventions except for PBO were associated with beneficial treatment effects relative to cDMARDs with the greatest effects being associated with TCZ (with and without MTX). The treatment effects were statistically significant for all interventions except for CTZ plus MTX, ADA, intensive cDMARDs and PBO at a conventional 5% level. There was insufficient evidence to differentiate between treatments although TCZ (mean rank 2.95; probability of being the best 0.251) and TCZ plus MTX (mean rank 3.28; probability of being the best 0.269) were the treatments that were most likely to be the most effective interventions.



**FIGURE 25** American College of Rheumatology (populations 2 and 3: main trials + RCTs that have potentially low prior MTX exposure) – network of evidence. Int, intensive. Solid green line (two-arm study); and dotted blue line (three-arm study).



**TABLE 44** American College of Rheumatology (populations 2 and 3: main trials + RCTs that have potentially low prior MTX exposure) – frequency with which each pair of interventions were compared

Intervention	cDMARDs	ABT i.v. + MTX	ADA + MTX	ADA	Intensive cDMARDs	ETN + MTX	ETN	GOL + MTX	IFX + MTX	PBO	TCZ + MTX	TCZ	CTZ + MTX	ABT s.c. + MTX
cDMARDs	-	2	5	-	1	5	2	2	3	1	1	2	1	-
ABT i.v. + MTX	-	-	-	-	-	-	-	-	1	-	-	-	-	-
ADA + MTX	-	-	-	-	-	-	-	-	-	-	-	-	-	1
ADA	-	-	-	-	-	-	-	-	-	2	-	1	-	-
Intensive cDMARDs	-	-	-	-	-	3	-	-	-	-	-	-	-	-
ETN + MTX	-	-	-	-	-	-	3	-	1	-	-	-	-	-
ETN	-	-	-	-	-	-	-	-	-	1	-	-	-	-
GOL + MTX	-	-	-	-	-	-	-	-	-	-	-	-	-	-
IFX + MTX	-	-	-	-	-	-	-	-	-	-	-	-	-	-
PBO	-	-	-	-	-	-	-	-	-	-	-	-	-	-
TCZ + MTX	-	-	-	-	-	-	-	-	-	-	-	1	-	-
TCZ	-	-	-	-	-	-	-	-	-	-	-	-	-	-
CTZ + MTX	-	-	-	-	-	-	-	-	-	-	-	-	-	-
ABT s.c. + MTX	-	-	-	-	-	-	-	-	-	-	-	-	-	-

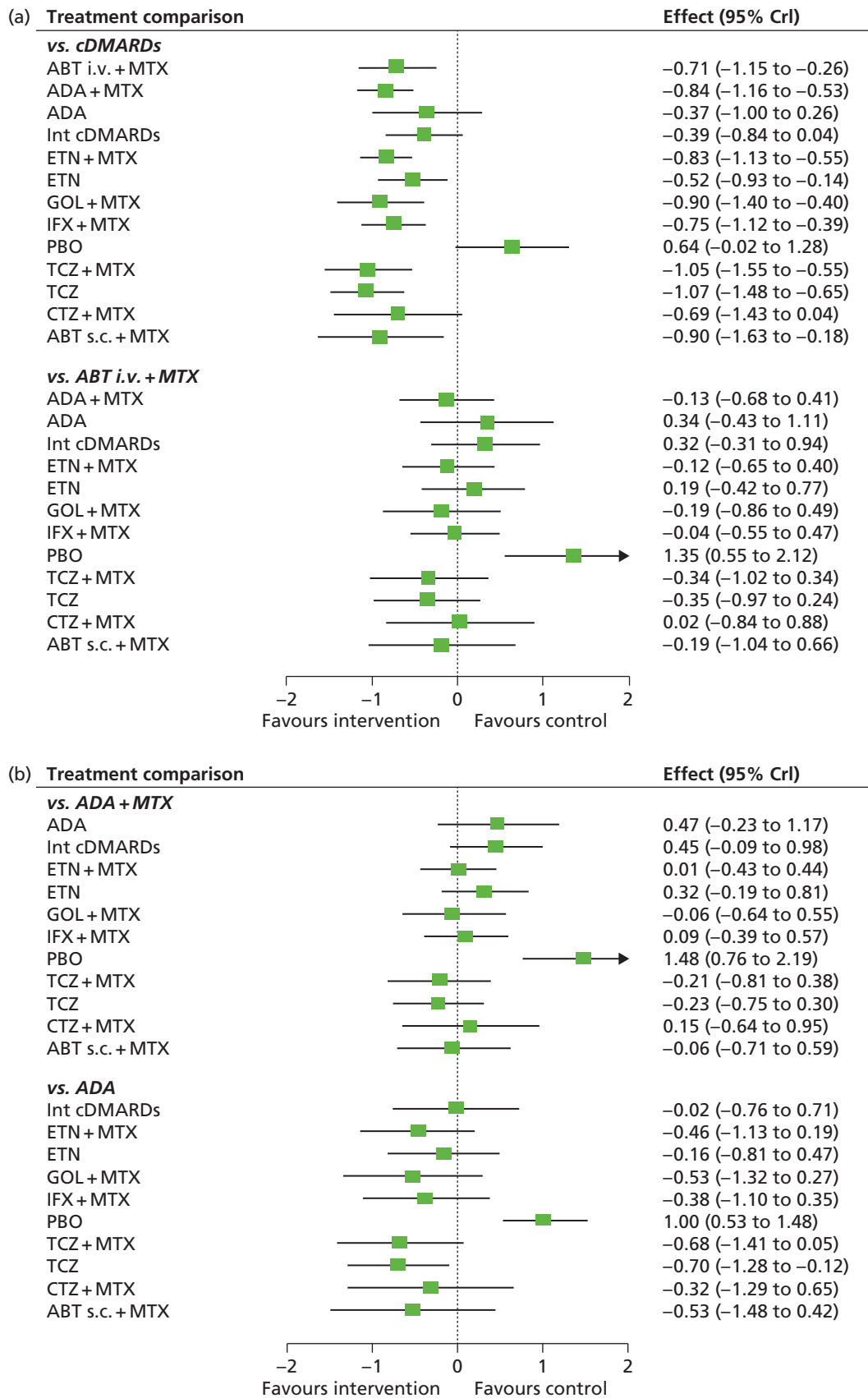


FIGURE 26 American College of Rheumatology (populations 2 and 3: main trials + RCTs that have potentially low prior MTX exposure) – effects of interventions relative to cDMARDs on the probit scale. Int, intensive. (continued)

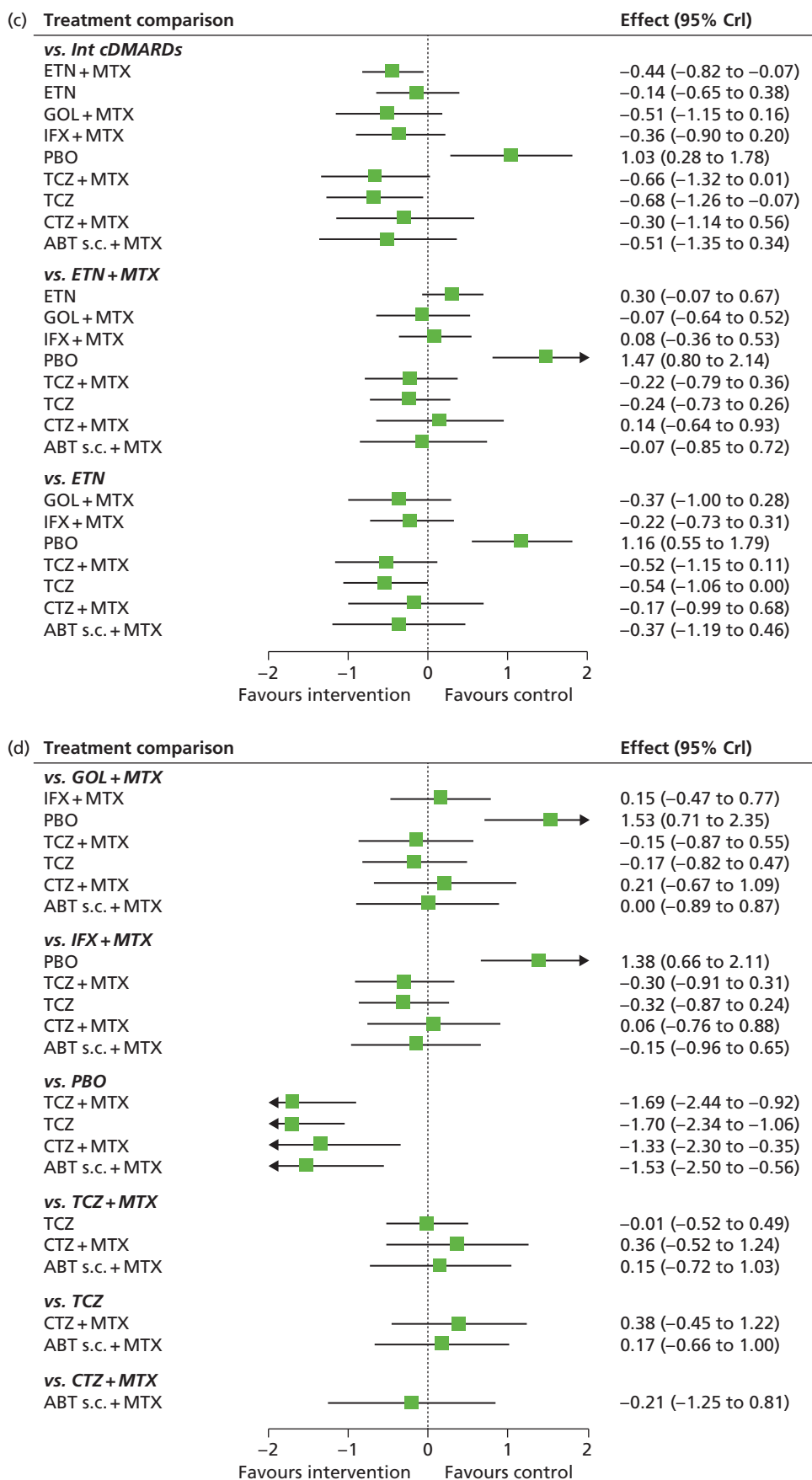
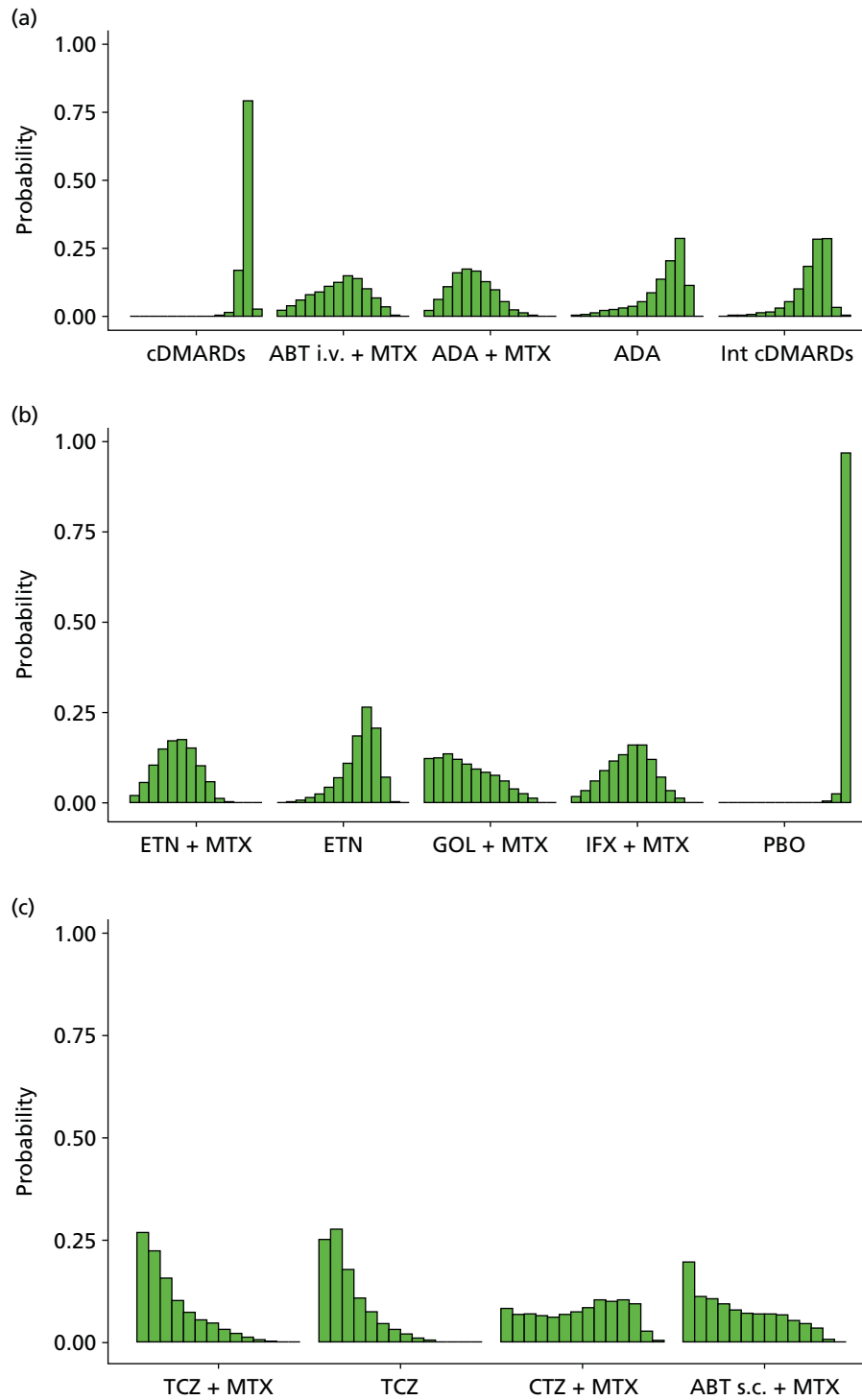


FIGURE 26 American College of Rheumatology (populations 2 and 3: main trials + RCTs that have potentially low prior MTX exposure) – effects of interventions relative to cDMARDs on the probit scale. Int, intensive.



**FIGURE 27** American College of Rheumatology (populations 2 and 3: main trials+RCTs that have potentially low prior MTX exposure) – probability of treatment rankings in terms of efficacy (most efficacious = 1). Int, intensive.

**TABLE 45** American College of Rheumatology (populations 2 and 3: main trials + RCTs that have potentially low prior MTX exposure) – probability of treatment rankings in terms of efficacy (most efficacious = 1)

Intervention	Rank (mean)	Rank														
		1	2	3	4	5	6	7	8	9	10	11	12	13	14	
cDMARDs	12.83	0.000	0.000	0.000	0.000	0.000	0.000	0.000	0.000	0.000	0.000	0.001	0.015	0.167	0.791	0.026
ABT i.v. + MTX	7.12	0.019	0.037	0.058	0.078	0.089	0.108	0.124	0.147	0.137	0.099	0.099	0.068	0.034	0.002	0.000
ADA + MTX	5.48	0.020	0.068	0.109	0.159	0.174	0.165	0.127	0.095	0.054	0.025	0.025	0.010	0.001	0.000	0.000
ADA	10.32	0.002	0.006	0.012	0.019	0.022	0.028	0.036	0.054	0.085	0.134	0.203	0.285	0.113	0.000	0.000
Intensive cDMARDs	10.47	0.001	0.002	0.002	0.006	0.011	0.015	0.029	0.053	0.100	0.183	0.281	0.284	0.031	0.002	0.002
ETN + MTX	5.48	0.020	0.056	0.105	0.148	0.170	0.176	0.151	0.103	0.057	0.012	0.002	0.000	0.000	0.000	0.000
ETN	9.28	0.001	0.003	0.008	0.014	0.024	0.043	0.068	0.110	0.184	0.264	0.206	0.071	0.003	0.000	0.000
GOL + MTX	4.91	0.122	0.125	0.136	0.120	0.108	0.094	0.085	0.076	0.061	0.039	0.025	0.011	0.001	0.000	0.000
IFX + MTX	6.60	0.017	0.034	0.061	0.088	0.116	0.133	0.158	0.157	0.119	0.072	0.034	0.011	0.000	0.000	0.000
PBO	13.96	0.000	0.000	0.000	0.000	0.000	0.000	0.000	0.000	0.000	0.000	0.001	0.005	0.025	0.968	0.000
TCZ + MTX	3.28	0.269	0.224	0.157	0.102	0.072	0.055	0.047	0.032	0.023	0.012	0.006	0.002	0.000	0.000	0.000
TCZ	2.95	0.251	0.275	0.178	0.108	0.074	0.046	0.032	0.021	0.011	0.004	0.001	0.000	0.000	0.000	0.000
CTZ + MTX	7.18	0.082	0.066	0.068	0.065	0.061	0.066	0.074	0.085	0.104	0.101	0.103	0.094	0.027	0.003	0.003
ABT s.c. + MTX	5.10	0.196	0.111	0.106	0.093	0.078	0.070	0.069	0.068	0.067	0.054	0.046	0.034	0.007	0.001	0.001

A meta-analysis was used to estimate the proportion of patients experiencing an ACR 'no response' when treated with cDMARDs.

Data were available from 20 studies.<sup>53,54,62,69,70,74–76,79,84,89,91,92,96,99,115–118,121,124,160</sup>

The model fitted the data well, with the total residual deviance, 19.53, close to the total number of data points, 20, included in the analysis.

The between-study SD was estimated to be 0.37 (95% CrI 0.26 to 0.55), which implies mild to moderate heterogeneity between studies in the baseline response. The addition of the TEAR<sup>53</sup> and TEMPO<sup>54</sup> studies has increased the variability between studies in the CDMARDs 'no response' rate relative to that estimated from the main studies alone.

Table 46 presents the probabilities of achieving at least an ACR20, an ACR50 and an ACR70. These are derived by combining the treatment effects estimated from the NMA with the estimate of the cDMARDs 'no response' rate.

**TABLE 46** American College of Rheumatology (populations 2 and 3: main trials + RCTs that have potentially low prior MTX exposure) – probability of achieving ACR responses

Intervention	At least ACR20 (95% CrI)	At least ACR50 (95% CrI)	At least ACR70 (95% CrI)
cDMARDs	0.323 (0.264 to 0.389)	0.136 (0.102 to 0.180)	0.046 (0.031 to 0.067)
ABT i.v. + MTX	0.601 (0.410 to 0.767)	0.351 (0.192 to 0.537)	0.166 (0.073 to 0.309)
ADA + MTX	0.649 (0.509 to 0.771)	0.400 (0.268 to 0.542)	0.199 (0.113 to 0.315)
ADA	0.466 (0.228 to 0.713)	0.234 (0.083 to 0.472)	0.095 (0.024 to 0.256)
Intensive cDMARDs	0.473 (0.296 to 0.662)	0.240 (0.120 to 0.412)	0.098 (0.039 to 0.209)
ETN + MTX	0.645 (0.515 to 0.765)	0.396 (0.273 to 0.534)	0.197 (0.117 to 0.307)
ETN	0.526 (0.360 to 0.695)	0.284 (0.160 to 0.450)	0.123 (0.057 to 0.238)
GOL + MTX	0.670 (0.463 to 0.833)	0.421 (0.232 to 0.629)	0.216 (0.093 to 0.398)
IFX + MTX	0.614 (0.456 to 0.758)	0.364 (0.227 to 0.525)	0.175 (0.090 to 0.300)
PBO	0.136 (0.039 to 0.337)	0.042 (0.008 to 0.146)	0.010 (0.001 to 0.050)
TCZ + MTX	0.723 (0.524 to 0.870)	0.483 (0.280 to 0.689)	0.264 (0.121 to 0.462)
TCZ	0.729 (0.563 to 0.857)	0.489 (0.316 to 0.666)	0.268 (0.142 to 0.437)
CTZ + MTX	0.593 (0.300 to 0.839)	0.343 (0.122 to 0.637)	0.160 (0.040 to 0.406)
ABT s.c. + MTX	0.670 (0.383 to 0.883)	0.422 (0.175 to 0.710)	0.216 (0.063 to 0.487)

## Discussion of systematic reviewing results

This review differed from other reviews of biologics in RA,<sup>123,161–172</sup> in that it included only licensed doses of biologics, was limited to first-line biologics, and considered separately MTX-naive and cDMARD-experienced trials.

Sixty trials met the inclusion criteria for the systematic review of clinical effectiveness and safety evidence. Of these, 38 trials were also used in the NMA<sup>56–126,141,160</sup> (eight for population 1 and 30 for populations 2 and 3).

Seven MTX-naive trials<sup>78,81–83,87,90,94,108,109</sup> and 24 cDMARD-experienced trials<sup>57,58,61–65,68–70,74–76,79,80,84,85,88,89,91,92,96,97,99,102,104,105,111,112,115–119,121,122,124,141,160</sup> (of which four were head-to-head evidence<sup>58,66,74,85</sup>) were included in the NMA for ACR response. One MTX-naive trial and 15 cDMARD experienced trials were included in the NMA for EULAR data.

In addition, 14 trials (12 trials with interventions of interest<sup>53–55,127–136</sup> and two TOF trials<sup>137,138</sup>) were included in sensitivity analyses for populations 2 and 3 (all 14 with ACR data and 3 with EULAR data). Two of these trials (presenting ACR data only) were used in sensitivity analyses for population 1.<sup>53,54</sup>

Many of the trials were of good quality (see *Figure 3*). They were mostly Phase III trials. Some trials did not report in enough detail to judge randomisation method or allocation concealment, or if all outcomes were reported. Further details regarding study quality are provided in *Table 333* (see *Appendix 4*).

There were several large, multinational, multicentre studies. A few trials were conducted in a single country. For the cDMARD-experienced population, some trial populations may not have had adequate MTX to class as failure. Of particular note, for populations 2 and 3, are the trials that were conducted in Japan only, as some of these trials also utilised low-dose MTX treatment prior to randomisation, potentially impacting on the extent of MTX failure among trial populations and restricting external validity to the UK. Further details regarding geographical location are provided in *Tables 335–338* (see *Appendix 4*). Based on the results shown within the company submissions made by AbbVie<sup>173</sup> and MSD,<sup>159,174</sup> which did not show a marked difference when Asian studies were excluded, no formal analyses were undertaken removing such studies.

The issues relating to the external validity of RCTs in RA, including (1) the application of strict trial inclusion criteria resulting in narrower study populations relative to RA clinical practice and (2) the limitations of RCTs in general in capturing rare AEs, have been previously discussed and should be borne in mind when considering the generalisability of the trial evidence.<sup>175,176</sup> Some trials had step-up therapy, which in the opinion of our clinical advisors is consistent with real-world practice.

Strengths of this systematic review included the undertaking of a comprehensive search for evidence; the extensive number of RCTs that were identified relating to the decision problem; data were identified for all interventions of interest; there were long-term safety data from LTEs of trials; trials that were not eligible for inclusion in the systematic review or NMA base case (e.g. trials with populations having  $\leq 20\%$  prior biologic experience) were explored in sensitivity analyses; and graphical data for the NMA were extracted using Engauge version 4.1.

Limitations of the review included evidence was restricted to English-language publications; ongoing/unpublished trial resources could not be explored owing to the time scales of the assessment; some studies (and consequently some interventions) could not be included in a NMA of EULAR outcome data where this was not reported; and, owing to the extensive variability in the range of available outcome measures reported in trials, it was necessary to prioritise the assessment of the most widely used measures.

Although there was uncertainty in, and overlap between, the effects of treatment on ACR for interventions for patients in population 1, IFX plus MTX was associated with the biggest increase in response rate and this was likely to be the most effective intervention. Other interventions were less effective and appeared to fall into three groups: (1) ETN plus MTX, intensive cDMARDs and ADA plus MTX; (2) GOL plus MTX, ETN and step-up intensive cDMARDs; and (3) cDMARDs and ADA.

Although there was uncertainty in, and overlap between, the effects of treatment on EULAR for interventions in populations 2 and 3 in the main trials, TCZ, TCZ plus MTX and ETN plus MTX were associated with the biggest increase in response rate. Other interventions were less effective and appeared to fall into two groups: (1) GOL plus MTX, CTZ plus MTX, ADA, grouped biologics, ETN, ADA plus MTX, ABT i.v. plus MTX and IFX plus MTX; and (2) intensive cDMARDs, PBO and cDMARDs. The inclusion of the additional studies in which patients received prior biologics resulted in broadly the same groupings, although the effect of CTZ plus MTX was much greater and similar to that for TCZ, TCZ plus MTX and ETN plus MTX.

Although there was uncertainty in, and overlap between, the effects of treatment on ACR for interventions in populations 2 and 3 in the main trials, ETN plus MTX, TCZ and TCZ plus MTX, were associated with the biggest increase in response rate. Other interventions were less effective and appeared to fall into two groups: (1) ETN, GOL plus MTX, ABT s.c. plus MTX, ADA plus MTX, INF plus MTX, CTX plus MTX and ATB i.v. plus MTX; and (2) intensive cDMARDs, ADA and cDMARDs. The inclusion of the additional studies in which patients received prior biologics suggested resulted in a greater estimate of the effect of CTZ plus MTX. Other interventions appeared to give rise to broadly similar response rates.

### *Other efficacy outcomes*

#### **Population 1: methotrexate naive**

Where there was step-up therapy with initial biologic or control, the groups were similar after 6 months to a year (i.e. after step-up). Biologic monotherapy was better than PBO, but similar to MTX. Biologic combined with MTX was better than MTX plus PBO.

#### **Populations 2 and 3: conventional disease-modifying antirheumatic drugs experienced**

Head-to-head trials indicate similarity of biologics. One exception was the ADACTA trial.<sup>58</sup>

This reported greater improvement with TCZ monotherapy than ADA monotherapy for DAS and mental component summary of SF-36 at 24 weeks,<sup>58</sup> although this trial had similar results for ADA and TCZ for swollen and tender joint counts, and fatigue. This suggests that the impacts of different biologics on different outcomes may not be straightforward.

Biologics combined with MTX treatment arms reported more improvement than non-biologic control arms with one or two cDMARDs or baseline cDMARDs. Biologics combined with MTX did better than biologic monotherapy, except for TCZ for joint counts and HAQ-DI.



## Chapter 4 Assessment of cost-effectiveness

### Systematic review of existing cost-effectiveness evidence

The Assessment Group conducted a systematic review of published economic evaluations undertaken of the RA interventions being assessed. The objective of this systematic review is to summarise the existing economic evidence for the use of each intervention in patients with RA. The systematic review will assess the strengths and limitations of each specific economic evaluation.

#### Methods for reviewing existing cost-effectiveness evidence

Systematic searches of online databases were undertaken to identify all published economic evaluations of disease-modifying therapies for RA. To ensure that the systematic search had high sensitivity, the search was developed by applying economic terms to a general disease search for RA and disease-modifying therapies. Database filters to identify economic evaluations were used from the InterTASC Information Specialists' Sub-Group website [www.york.ac.uk/inst/crd/intertasc/index.htm (accessed 5 July 2013)]. The keywords used for the systematic review are provided in *Table 47*.

The search strategies used medical subject heading terms, including 'rheumatoid arthritis' and 'economics' and text string terms, which were combined in the search strategy using Boolean logic. The search strategies were designed to maximise sensitivity (i.e. the identification of all appropriate studies); however, this was at the cost of poor specificity (the rejection of inappropriate studies). This meant the search returned a lot of inappropriate studies and was reliant on hand-sifting, including the removal of economic evaluations of treatments that are not included in this appraisal (RTX, conventional DMARDs, anakinra, etc.).

Systematic searches were conducted in 10 databases provided in *Table 48*. Reference search was undertaken on all included studies, including any identified reviews of published economic evaluations of disease-modifying therapies for RA.

All database searches were undertaken on 1 February 2013 and no date restriction was applied. No study type or language restrictions were applied to the electronic search. The search strategies were reviewed by an information specialist.

The objective of the systematic search was to identify economic evaluations of ABT, ADA, CTZ, ETN, GOL, IFX and TCZ within populations 1, 2 and 3. The search was irrespective of the decision-making context or the geographical location. The eligibility criteria are presented in *Box 1*.

The identified studies were appraised using the commonly used and validated Drummond checklist.<sup>177</sup>

**TABLE 47** Keywords for systematic review

Population	RA
Intervention/comparator	Disease modifying, disease-modifying, DMARD, biologic, therapy, treatment, anti-rheumatic, anti rheumatic, TNF, tumor necrosis factor alpha, tumour necrosis factor alpha, TNF-alpha, TNF inhibitor, TNF blocker, interleukin 1, IL-1, monoclonal antibody, costimulation blocker, interleukin 6, IL-6
Outcomes	Economic, economics, cost, cost-effectiveness, cost-utility, cost-benefit, utility, health related quality of life, quality of life, quality adjusted life year, QALY
IL-1, interleukin 1; IL-6, interleukin 6; QALY, quality-adjusted life-year.	

**TABLE 48** Systematic review databases

Database	Date
Bioscience Information Service (all databases)	1899–February 2013
Cochrane Database of Systematic Reviews	All years–February 2013
Cochrane Database of Methodological Reviews	All years–February 2013
Cochrane Central Register of Controlled Trials	All years–February 2013
Database of Abstracts of Reviews and Effects	All years–February 2013
CINAHL	1994–February 2013
EMBASE	1974–February 2013
MEDLINE	1945–February 2013
NHS Economic Evaluations Database	All years–February 2013
Science Citation Index: Web of Science	1899–February 2013

**BOX 1** Eligibility criteria**Inclusion criteria**

Economic evaluation including a comparison of costs and benefits based on outcomes data or undertaken using decision-analytic methods.

Economic evaluations of interventions targeting a change to the natural disease profile of people with RA (i.e. disease-modifying therapies).

Studies reporting costs and health outcomes.

**Exclusion criteria**

Evaluations of treatments not under review in this appraisal.

Evaluations in patient populations not under review in this appraisal (e.g. sequential biologics).

Partial or non-comparative economic evaluations.

Cost analyses/cost-of-illness/burden-of-illness studies.

Methodological papers that do not report economic and health benefit outcomes.

Commentaries, letters, editorials.

Conference abstracts.

Studies that claim cost-effectiveness, but with no empirical estimation of the costs and effectiveness outcomes.

Economic evaluations of therapies and treatments which do not modify the natural progression of RA.

Non-English language.

## Results

From the systematic searching of electronic databases, 8281 citations were identified (*Figure 28*). After excluding 3250 duplicate citations electronically, the remaining 5031 citations were screened by their abstract. Of these, 4913 abstracts did not meet the inclusion criteria and 118 full-text papers were retrieved for a full inspection. A total of 97 papers were excluded for not meeting the inclusion criteria, and nine other studies were identified by reference searches and searching any identified systematic reviews. A total of 30 studies were included in the systematic review.

The studies identified are summarised in *Table 49*. Twenty-three of the 30 studies (77%) were evaluations of bDMARDs in patients who had already had DMARD therapy previously. Six studies (20%) were in DMARD-naive patients, with one study (3%) in both DMARD-naive and -experienced populations.

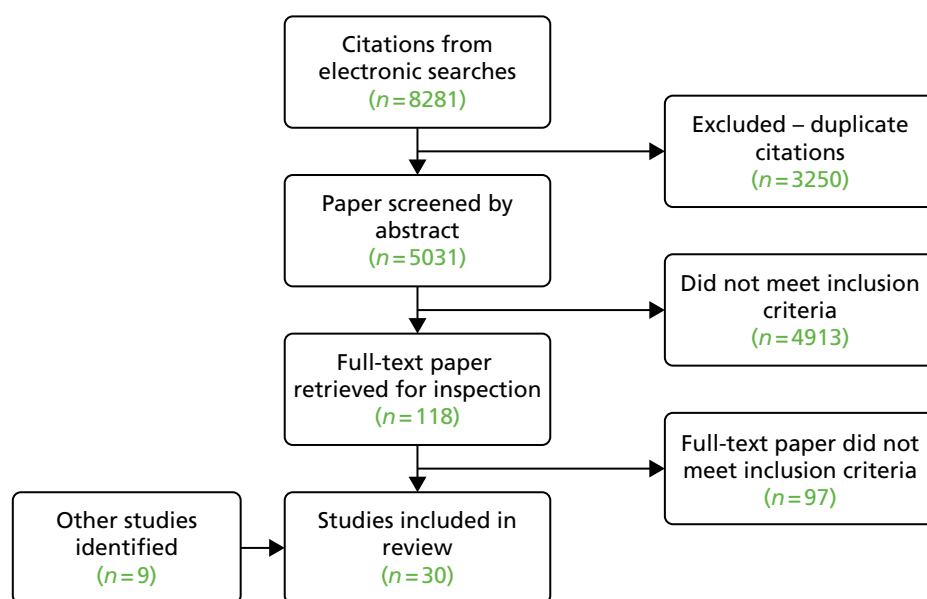
No studies were identified that evaluated GOL and CTZ, with the majority focusing on ETN, IFX and ADA.

A total of 27 of the 30 studies (90%) were cost–utility analyses and a wide range of model methods and time horizons were adopted.

For ease of reading, the cost-effectiveness results are split into cDMARD-naive (*Table 50*) and bDMARD-naive (*Table 51*) populations.

The range of price year, currencies, discount rates and time horizons means that drawing strong conclusions regarding the cost-effectiveness of particular therapies is not possible, and would probably be misleading. In addition, the complex nature of RA and the range of parameters required to develop a cost-effectiveness model mean that a very detailed review of each study would be required, which was not feasible. In some instances, the price year was not reported, and in a few cases it was not clear if bDMARDs were given with concomitant MTX or if they were a monotherapy. Results in GBP are all above the £30,000 per quality-adjusted life-year (QALY) threshold.

In general, the results in *Table 51* suggest that bDMARDs are unlikely to be cost-effective in patients who have not undertaken DMARD therapy.



**FIGURE 28** Quality of reporting of meta-analyses flow diagram.

TABLE 49 Health economic studies assessing bDMARDs in bDMARD-naive patients with RA

Study	Treatment history	Disease severity	Country (sponsor)	Interventions considered	Form of economic analysis	Model used	Time horizon
Bansback <i>et al.</i> , 2005 <sup>178</sup>	Two cDMARDs	Moderate/severe	Sweden (Abbott)	TNF- $\alpha$ with or without MTX vs. cDMARDs	CUA	Individual-level Markov model	Lifetime
Barbieri <i>et al.</i> , 2005 <sup>179</sup>	cDMARDs and resistant to MTX	Severe	UK (Schering-Plough)	IFX + MTX vs. MTX	CUA	Markov model	1 year and lifetime
Barton <i>et al.</i> , 2004 <sup>180</sup>	SSZ and MTX	Unclear	UK (HTA)	ETN vs. IFX vs. cDMARD sequence	CUA	Individual sampling model	Lifetime
Benucci <i>et al.</i> , 2009 <sup>181</sup>	Two cDMARDs	Moderate/severe	Italy (none reported)	ABT with LEF or MTX vs. ETN with LEF or MTX	CUA	Observational analysis	2 years
Brennan <i>et al.</i> , 2004 <sup>182</sup>	Two cDMARDs	Unclear	UK (Wyeth)	ETN vs. cDMARD sequence	CUA	Individual sampling model	Lifetime
Brennan <i>et al.</i> , 2007 <sup>183</sup>	At least two cDMARDs	Active	UK (BSRBR)	TNF- $\alpha$ vs. cDMARDs	CUA	Individual sampling model	Lifetime
Chen <i>et al.</i> , 2006 <sup>123</sup>	None (at least for first-line comparators)	Active	UK (HTA)	TNF- $\alpha$ with or without MTX at first line or third line	CUA	Individual sampling model	Lifetime
Chiou <i>et al.</i> , 2004 <sup>184</sup>	Unclear	Moderate/severe	USA (none reported)	AKR vs. ETN vs. ADA vs. IFX	CUA	Decision tree	1 year
Choi <i>et al.</i> , 2002 <sup>185</sup>	MTX	Unclear	USA (no funding source)	cDMARD monotherapy and combination vs. bDMARD monotherapy and combination	CEA	Decision tree	6 months
Coyle <i>et al.</i> , 2006 <sup>186</sup>	None	Aggressive	Canada (CCOHTA)	GLD vs. bDMARD monotherapy and combination	CUA	Markov model	5 years
Davies <i>et al.</i> , 2009 <sup>187</sup>	None	Unclear	USA (Abbott)	MTX vs. ADA + MTX vs. ETN vs. IFX + MTX vs. ADA + MTX	CUA	Individual sampling model	Lifetime
Diamantopoulos <i>et al.</i> , 2012 <sup>188</sup>	cDMARDs	Moderate/severe	Italy (Roche)	Sequential bDMARD use	CUA	Individual sampling model	lifetime
Finckh <i>et al.</i> , 2009 <sup>189</sup>	None	Active	USA (Arthritis Foundation)	Symptomatic therapy vs. MTX vs. bDMARDs	CUA	Individual sampling model	Lifetime
Jobanputra <i>et al.</i> , 2002 <sup>172</sup>	SSZ and MTX	Active	UK (HTA)	Adding ETN and IFX into a cDMARD sequence	CUA	Individual sampling model	Lifetime
Kobelt <i>et al.</i> , 2003 <sup>190</sup>	cDMARDs including MTX IR	Unclear, 'advanced'	Sweden, UK (Schering-Plough)	IFX + MTX vs. MTX	CUA	Markov model	10 year

TABLE 49 Health economic studies assessing bDMARDs in bDMARD-naive patients with RA (continued)

Study	Treatment history	Disease severity	Country (sponsor)	Interventions considered	Form of economic analysis	Model used	Time horizon
Kobelt <i>et al.</i> , 2004 <sup>191</sup>	Two cDMARDs including MTX IR	Unclear	Sweden (multiple funders)	TNF- $\alpha$ vs. cDMARDs	CUA	Trial analysis	1 year
Kobelt <i>et al.</i> , 2005 <sup>192</sup>	cDMARDs other than MTX	Severe	Sweden (Wyeth)	ETN vs. MTX vs. ETN + MTX	CUA	Markov model	5 years/10 years
Kobelt <i>et al.</i> , 2011 <sup>193</sup>	None	Severe	Sweden (Wyeth)	ETN + MTX vs. MTX	CUA	Markov model	10 years
Lekander <i>et al.</i> , 2010 <sup>194</sup>	No TNF- $\alpha$ s	Active	Sweden (Schering-Plough)	IFX vs. cDMARDs	CUA	Markov model	20 years
Marra <i>et al.</i> , 2007 <sup>195</sup>	cDMARDs	Active	Canada (none reported)	IFX + MTX vs. MTX	CUA	Markov model	10 years
Nuijten <i>et al.</i> , 2001 <sup>196</sup>	Two cDMARDs	Unclear	The Netherlands (Wyeth)	ETN vs. IFX	CMA	Unclear	1 year
Rubio-Terrés and Dominguez-Gil, 2001 <sup>197</sup>	cDMARDs (including MTX)	Active	Spain (none reported)	IFX + MTX vs. LEF	CMA	Unclear	1 year
Soini <i>et al.</i> , 2012 <sup>198</sup>	At least one cDMARD	Moderate/severe	Finland (Roche)	ADA vs. ETN vs. TCZ	CUA	Individual sampling model	Lifetime
Spalding and Hay, 2006 <sup>199</sup>	None	Unclear	USA (University of Southern California)	MTX vs. bDMARD monotherapy and combination	CUA	Markov model	Lifetime
Tanno <i>et al.</i> , 2006 <sup>200</sup>	Bucillamine	Unclear	Japan (Japanese Government)	Adding ETN to a cDMARD sequence	CUA	Markov model	Lifetime
van den Hout <i>et al.</i> , 2009 <sup>201</sup>	None	Active	The Netherlands (multiple funders)	Comparing cDMARD combination vs. IFX combination therapy	CUA	Trial analysis	2 years
Vera-Llonch <i>et al.</i> , 2008 <sup>202</sup>	MTX	Moderate/severe	USA (none reported)	ABT vs. cDMARDs	CUA	Individual sampling model	Lifetime
Wailoo <i>et al.</i> , 2008 <sup>203</sup>	No bDMARDs	Unclear	USA (US AHRQ)	ETN vs. ADA vs. AKR vs. IFX	CUA	Individual sampling model	Lifetime
Welsing <i>et al.</i> , 2004 <sup>204</sup>	cDMARDs	Active	The Netherlands (none reported)	Usual care vs. LEF vs. TNF- $\alpha$ vs. LEF, TNF- $\alpha$ sequences	CUA	Markov model	5 years
Wong <i>et al.</i> , 2002 <sup>205</sup>	MTX	Active refractory disease	USA (Schering-Plough, NIH)	IFX + MTX vs. MTX	CUA	Markov model	Lifetime

AHRQ, Agency for Healthcare Research and Quality; AKR, anakinra; CCOHTA, Canadian Coordinating Office For Health Technology Assessment; CEA, cost-effectiveness analysis; CMA, cost-minimisation analysis; CUA, cost-utility analysis; IR, inadequate responder; NIH, National Institutes of Health; US AHRQ, United States Agency for Healthcare Research & Quality.

TABLE 50 Cost-effectiveness results for studies in DMARD-naive patients with RA

Drug	Comparator	Study	Price year	Time horizon	Previous treatments	ICER (per QALY gained)
ADA	MTX	Spalding and Hay, 2006 <sup>199</sup>	2005	Lifetime	None	US\$64,000
	cDMARDs	Chen <i>et al.</i> , 2006 <sup>123</sup>	2004	Lifetime	None	£53,000
ADA + MTX	MTX	Spalding and Hay, 2006 <sup>199</sup>	2005	Lifetime	None	US\$195,000
	cDMARDs	Davies <i>et al.</i> , 2009 <sup>187</sup>	2007	Lifetime	None	US\$23,000
	cDMARDs	Chen <i>et al.</i> , 2006 <sup>123</sup>	2004	Lifetime	None	£170,000
ETN	MTX	Spalding and Hay, 2006 <sup>199</sup>	2005	Lifetime	None	US\$90,000
	cDMARDs	Chen <i>et al.</i> , 2006 <sup>123</sup>	2004	Lifetime	None	£49,000
	cDMARDs	Davies <i>et al.</i> , 2009 <sup>187</sup>	2007	Lifetime	None	US\$28,000
ETN + MTX	MTX	Kobelt <i>et al.</i> , 2011 <sup>193</sup>	2008	10 years	None	€14,000
	cDMARDs	Coyle <i>et al.</i> , 2006 <sup>186</sup>	?	5 years	None	Before/after GLD = CA\$145,000/ CA\$126,000
	cDMARDs	Chen <i>et al.</i> , 2006 <sup>123</sup>	2004	Lifetime	None	£78,000
IFX + MTX	MTX	Spalding and Hay, 2006 <sup>199</sup>	2005	Lifetime	None	US\$410,000
	cDMARDs	Coyle <i>et al.</i> , 2006 <sup>186</sup>	?	5 years	None	Before/after GLD = CA\$113,000/ CA\$98,000
	cDMARDs	Davies <i>et al.</i> , 2009 <sup>187</sup>	2007	Lifetime	None	US\$32,000
	cDMARDs	Chen <i>et al.</i> , 2006 <sup>123</sup>	2004	Lifetime	None	£650,000
	Combination cDMARDs	van den Hout <i>et al.</i> , 2009 <sup>201</sup>	2008	2 years	None	€130,000
TNF- $\alpha$	cDMARDs	Finckh <i>et al.</i> , 2009 <sup>189</sup>	2007	Lifetime	None	Dominated

?, not stated; ICER, incremental cost-effectiveness ratio; QALY, quality-adjusted life-year.

TABLE 51 Cost-effectiveness results for studies in bDMARD-naive patients with RA

Drug	Comparator	Study	Price year	Time horizon	Previous treatments	ICER (per QALY gained)
ABT i.v. + MTX	MTX	Vera-Llonch <i>et al.</i> , 2008 <sup>202</sup>	2006	Lifetime	MTX	US\$46,000
ADA	MTX	Bansback <i>et al.</i> , 2005 <sup>178</sup>	2001	Lifetime	Two previous cDMARDs	€42,000
	cDMARDs	Chen <i>et al.</i> , 2006 <sup>123</sup>	2004	Lifetime	Two previous cDMARDs	£35,000–140,000
	Anakinra	Chiou <i>et al.</i> , 2004 <sup>184</sup>	2003	1 year	Unclear	Dominated
	Anakinra	Wailoo <i>et al.</i> , 2008 <sup>203</sup>	?	Lifetime	No bDMARDs	US\$143,000
	IFX + MTX	Wailoo <i>et al.</i> , 2008 <sup>203</sup>	?	Lifetime	No bDMARDs	Dominates
ADA + MTX	MTX	Bansback <i>et al.</i> , 2005 <sup>178</sup>	2001	Lifetime	Two previous cDMARDs	€34,000
	MTX	Soini <i>et al.</i> , 2012 <sup>198</sup>	2010	Lifetime	At least one cDMARD	€21,000
	cDMARDs	Chen <i>et al.</i> , 2006 <sup>123</sup>	2004	Lifetime	Two previous cDMARDs	£30,000–64,000
	Anakinra	Chiou 2004 <sup>184</sup>	2003	1 year	Unclear	Dominated
ETN	MTX	Bansback <i>et al.</i> , 2005 <sup>178</sup>	2001	Lifetime	Two previous cDMARDs	€37,000
	MTX	Tanno <i>et al.</i> , 2006 <sup>200</sup>	2005	Lifetime	Bucillamine	Yen 2.5M
	MTX	Kobelt <i>et al.</i> , 2005 <sup>192</sup>	2004	5 years/10 years	cDMARDs other than MTX	5 years/10 years = €152,000/124,000
	cDMARDs	Chen <i>et al.</i> , 2006 <sup>123</sup>	2004	Lifetime	Two previous cDMARDs	£24,000–47,000
	Anakinra	Chiou <i>et al.</i> , 2004 <sup>184</sup>	2003	1 year	Unclear	US\$13,000
	IFX + MTX	Nuijten <i>et al.</i> , 2001 <sup>196</sup>	1999	1 year	Two cDMARDs	Dominates
	ETN + MTX and cDMARD strategies	Choi <i>et al.</i> , 2002 <sup>185</sup>	1999	6 months	MTX	Extendedly dominated

continued

**TABLE 51** Cost-effectiveness results for studies in bDMARD-naive patients with RA (*continued*)

Drug	Comparator	Study	Price year	Time horizon	Previous treatments	ICER (per QALY gained)
ETN + MTX	MTX	Bansback <i>et al.</i> , 2005 <sup>178</sup>	2001	Lifetime	Two previous cDMARDs	€36,000
	MTX	Soini <i>et al.</i> , 2012 <sup>198</sup>	2010	Lifetime	At least one cDMARD	€21,000
	MTX	Kobelt <i>et al.</i> , 2005 <sup>192</sup>	2004	5 years/10 years	cDMARDs other than MTX	5 years/10 years = €55,000/37,000
	cDMARDs	Barton <i>et al.</i> , 2004 <sup>180</sup>	2000	Lifetime	SSZ and MTX	£50,000
	cDMARDs	Brennan <i>et al.</i> , 2004 <sup>182</sup>	2000	Lifetime	Two cDMARDs	£16,000
	cDMARDs	Jobanputra <i>et al.</i> , 2002 <sup>172</sup>	2000	Lifetime	SSZ and MTX	£64,000
	cDMARDs	Chen <i>et al.</i> , 2006 <sup>123</sup>	2004	Lifetime	Two previous cDMARDs	£24,000–50,000
	Anakinra	Chiou <i>et al.</i> , 2004 <sup>184</sup>	2003	1 year	Unclear	US\$8000
	ADA + MTX	Benucci <i>et al.</i> , 2009 <sup>181</sup>	?	2 years	Two cDMARDs	US\$25,000
	ADA + MTX	Wailoo <i>et al.</i> , 2008 <sup>203</sup>	?	Lifetime	No bDMARDs	US\$92,000
	IFX + MTX	Wailoo <i>et al.</i> , 2008 <sup>203</sup>	?	Lifetime	No bDMARDs	Dominates
	IFX + MTX	Barton <i>et al.</i> , 2004 <sup>180</sup>	2000	Lifetime	SSZ and MTX	£28,000
	IFX + MTX	Jobanputra <i>et al.</i> , 2002 <sup>172</sup>	2000	Lifetime	SSZ and MTX	£35,000
	IFX + MTX	Nuijten <i>et al.</i> , 2001 <sup>196</sup>	1999	1 year	Two cDMARDs	Dominates
	ETN	Choi <i>et al.</i> , 2002 <sup>185</sup>	1999	6 months	MTX	US\$43,000 (per ACR20 response), US\$35,000 (per ACR70 response)



TABLE 51 Cost-effectiveness results for studies in bDMARD-naive patients with RA (continued)

Drug	Comparator	Study	Price year	Time horizon	Previous treatments	ICER (per QALY gained)
IFX + MTX	MTX	Bansback <i>et al.</i> , 2005 <sup>178</sup>	2001	Lifetime	Two previous cDMARDs	€48,000
	MTX	Barbieri <i>et al.</i> , 2005 <sup>179</sup>	2000	1 year/lifetime	cDMARDs and resistant to MTX	£34,000 (1 year), £24,000 (lifetime)
	MTX	Kobelt <i>et al.</i> , 2003 <sup>190</sup>	?	10 years	cDMARDs including MTX IR	£22,000
	MTX	Marra <i>et al.</i> , 2007 <sup>195</sup>	2002	10 years	cDMARDs	US\$46,000
	MTX	Wong <i>et al.</i> , 2002 <sup>205</sup>	1998	Lifetime	MTX	US\$307,000
	LEF	Rubio-Terrés <i>et al.</i> , 2001 <sup>197</sup>	1999	1 year	cDMARDs (including MTX)	Dominated (CMA)
	cDMARDs	Barton <i>et al.</i> , 2004 <sup>180</sup>	2000	Lifetime	SSZ and MTX	£68,000
	cDMARDs	Jobanputra <i>et al.</i> , 2002 <sup>172</sup>	2000	Lifetime	SSZ and MTX	£89,000
	cDMARDs	Lekander <i>et al.</i> , 2010 <sup>194</sup>	2007	20 years	No TNF-αs	€23,000
	cDMARDs	Chen <i>et al.</i> , 2006 <sup>123</sup>	2004	Lifetime	Two previous cDMARDs	£30,000–140,000
	Anakinra	Chiou <i>et al.</i> , 2004 <sup>184</sup>	2003	1 year	Unclear	Dominated
	ADA + MTX	Wailoo <i>et al.</i> , 2008 <sup>203</sup>	?	Lifetime	No bDMARDs	Dominated
	ETN + MTX	Wailoo <i>et al.</i> , 2008 <sup>203</sup>	?	Lifetime	No bDMARDs	Dominated
	TCZ + MTX	ETA + MTX	Diamantopoulos <i>et al.</i> , 2012 <sup>188</sup>	2009	Lifetime	cDMARDs
ADA + MTX		Diamantopoulos <i>et al.</i> , 2012 <sup>188</sup>	2009	Lifetime	cDMARDs	Dominates
IFX + MTX		Diamantopoulos <i>et al.</i> , 2012 <sup>188</sup>	2009	Lifetime	cDMARDs	€3000
Add TCZ into first biologic position		Diamantopoulos <i>et al.</i> , 2012 <sup>188</sup>	2009	Lifetime	cDMARDs	€17,000
MTX		Soini <i>et al.</i> , 2012 <sup>198</sup>	2010	Lifetime	At least one cDMARD	€19,000
Grouped bDMARDs	cDMARD	Brennan <i>et al.</i> , 2007 <sup>183</sup>	2004	Lifetime	At least two cDMARDs	£24,000
	Previous years' DMARD use	Kobelt <i>et al.</i> , 2004 <sup>191</sup>	2002	1 year	Two cDMARDs including MTX IR	€44,000
TNF-α	LEF	Welsing <i>et al.</i> , 2004 <sup>204</sup>	?	5 years	cDMARDs	€544,000

?, not stated; CMA, cost-minimisation analysis; ICER, incremental cost-effectiveness ratio; IR, inadequate responder; QALY, quality-adjusted life-year.

Like the DMARD-naive population, it is not possible to provide conclusions regarding the cost-effectiveness of individual treatments in the bDMARD-naive population.

Many bDMARDs have incremental cost-effectiveness ratios (ICERs) close to £30,000 per QALY threshold. No one bDMARD consistently seems to be cost-effective compared with any other bDMARD.

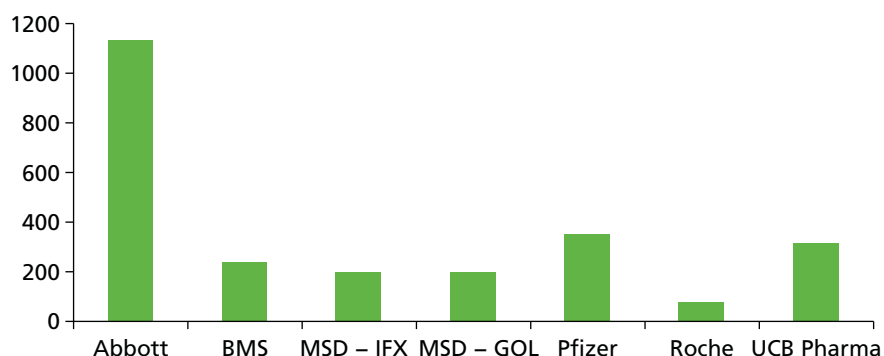
Jobanputra *et al.*,<sup>172</sup> Barton *et al.*<sup>180</sup> and Chen *et al.*<sup>123</sup> are HTA reports which informed the development of NICE TA36<sup>206</sup> and TA130.<sup>207</sup> Taking the most recent HTA report by Chen *et al.*,<sup>123</sup> ADA, ADA plus MTX, ETN, ETN plus MTX and IFX plus MTX all have ICERs compared with cDMARDs exceeding £20,000 per QALY, and in many instances above £30,000 per QALY. However, these drugs have since been recommended in certain patient populations. This highlights the sensitivity of cost-effectiveness models to key parameters and modelling assumptions, and careful consideration of all aspects is required to ensure confidence in the final reported ICERs.

### Critique of the manufacturers' submissions

The Assessment Group received submissions for seven interventions.<sup>152,156,159,173,174,208,209</sup> These were from six manufacturers as both GOL and IFX are manufactured by MSD. The submission by Bristol-Myers Squibb evaluated both the i.v. and s.c. formulations of ABT. The length and quality of the submissions varied. For information, *Figure 29* details the number of pages within each manufacturer's submission. In addition, each submission contained a mathematical model.

An initial review of the submissions indicated that there were a multitude of methods employed and that attempting to summarise all seven submissions individually would probably not aid the reader. With this aim, the submissions have been summarised jointly under a number of categories to allow the reader to compare and contrast the methodologies used. This would remove the need for cross-referencing were the reader wanting to know the different assumptions made for a key variable or to quickly compare outputs from the model. Formal evaluation of these models using checklists such as the *British Medical Journal* (BMJ) or Eddy checklists<sup>210,211</sup> was not possible within the time scales of the assessment; however, clear deviances from recommended methods have been outlined in the critique.

Where appropriate, tables and figures will be taken from the manufacturers' submissions. Minor amendments, such as to the intervention abbreviations, have been made to ensure consistency throughout the report, where possible.



**FIGURE 29** The number of pages in each submission (including appendices). BMS, Bristol-Myers Squibb.

The broad headings chosen were the:

- decision problem addressed
- strategies modelled
- model structure/time cycle
- time horizon
- perspective
- discounting
- population characteristics
- the assumed costs of the interventions
- costs of administration and monitoring
- comparative treatment efficacy (NMAs)
- responder criteria
- HAQ/EQ-5D changes in relation to response levels
- HAQ trajectory following initial response
- time to discontinuation of treatment
- rebound post treatment
- assumed NHS costs per HAQ band
- utility related to HAQ
- assumed costs and disutilities associated with AEs
- mortality associated with RA
- cost-effectiveness results
- cost implications within England and Wales.

### **Decision problem addressed**

Table 52 summarises the decision problems addressed within the manufacturers' submissions for those drugs that are licensed as monotherapy and for those that cannot. No detailed information is given in the tables which serve as reference only, with subtleties regarding each analysis provided in later sections. Four interventions (ABT i.v., ABT s.c., CTZ and TCZ) are not licensed before the use of MTX. Four interventions (ABT i.v., ABT s.c., GOL and IFX) are not licensed as monotherapy.

### **Summary**

It is seen that there was considerable variation in the decision problems addressed by the manufacturers with only the submissions by AbbVie and UCB Pharma evaluating all the subgroups within both the scope and the licence of their product.

### **Strategies modelled**

The strategies modelled for each submission have been detailed individually for each manufacturer collated by the analyses numbers provided in *Decision problem addressed*. These are:

1. population 3 in combination with MTX
2. population 2 in combination with MTX
3. population 1 in combination with MTX
4. population 3 monotherapy
5. population 2 monotherapy
6. population 1 monotherapy
7. general RA population who can receive MTX
8. MTX intolerant or contraindicated RA population.

**TABLE 52** The decision problem addressed within the manufacturers' submission

Analysis	Decision problem	Assessment group's interpretation of the scope	Manufacturer						
			AbbVie (ADA)	Bristol-Myers Squibb (ABT)	MSD (GOL)	MSD (IFX)	Pfizer (ETN)	Roche (TCZ)	UCB Pharma (CTZ)
1	Population 2 in combination with MTX	✓	✓		✓	✓	✓		✓
2	Population 3 in combination with MTX	✓	✓					✓	✓
3	Population 1 in combination with MTX	✓	✓					✓	
4	Population 2 monotherapy	✓	✓					✓	✓
5	Population 3 monotherapy	✓	✓						✓
6	Population 1 monotherapy	✓	✓						
7	General RA population who can tolerate MTX <sup>a</sup>			✓		✓	✓		
8	MTX intolerant or contraindicated RA population <sup>b</sup>								✓

a In essence, analyses 1 and 2 combined.

b In essence, analyses 4 and 5 combined.

Shaded cells indicate the intervention is not licensed in this population.

In summary, most strategies appeared reasonable, although it is noted that there were a few anomalies compared with NICE guidance or intervention licences:

1. MSD (GOL and IFX) and UCB Pharma (CTZ) assumed that TCZ would not be used following RTX.
2. MSD assumed in one strategy that RTX could be used without a bDMARD having been provided previously.
3. Pfizer (ETN) assumed that ABT i.v. would be used third line if TCZ was used first line.
4. Roche (TCZ) assumed a standard sequence of care for those intolerant or contraindicated to MTX that included three lines of bDMARDs, and evaluated only one sequence where TCZ was inserted as the first-line treatment to create four lines of bDMARDs.
5. Importantly, UCB Pharma did not compare with a cDMARD-only option for analyses 1 and 4.

### AbbVie

The strategies employed in the AbbVie submission are contained in *Tables 53–56*. These appear appropriate, although it is noted that 'rescue' treatment was not explicitly defined by the manufacturer.

### Bristol-Myers Squibb

The strategies employed in the Bristol-Myers Squibb submission are contained in *Table 57*. These appear appropriate.

The analyses assumed that if a patient had an AE within the first 6 months that a randomly sampled (and previously unused) bDMARD would be used instead.

**TABLE 53** Strategies modelled by AbbVie for analyses 1 and 2

Treatment number	Sequence number							
	1	2	3	4	5	6	7	8
1	LEF	ADA + MTX	ETN + MTX	IFX + MTX	CTZ + MTX	GOL + MTX	ABT + MTX	TCZ + MTX
2	SSZ	RTX + MTX	RTX + MTX	RTX + MTX	RTX + MTX	RTX + MTX	RTX + MTX	RTX + MTX
3	CYC	TCZ + MTX	TCZ + MTX	TCZ + MTX	TCZ + MTX	TCZ + MTX	TCZ + MTX	LEF
4	Rescue	LEF	LEF	LEF	LEF	LEF	LEF	SSZ
5		SSZ	SSZ	SSZ	SSZ	SSZ	SSZ	CYC
6		CYC	CYC	CYC	CYC	CYC	CYC	Rescue
7		Rescue	Rescue	Rescue	Rescue	Rescue	Rescue	

CYC, ciclosporin.

**TABLE 54** Strategies modelled by AbbVie for analysis 3

Treatment number	Sequence number					
	1	2	3	4	5	6
1	MTX	ADA + MTX	ETN + MTX	IFX + MTX	GOL + MTX	MTX + HCQ
2	SSZ	RTX + MTX	RTX + MTX	RTX + MTX	RTX + MTX	ADA + MTX
3	HCQ	TCZ + MTX	TCZ + MTX	TCZ + MTX	TCZ + MTX	RTX + MTX
4	LEF	LEF	LEF	LEF	LEF	TCZ + MTX
5	CYC	SSZ	SSZ	SSZ	SSZ	LEF
6	Rescue	CYC	CYC	CYC	CYC	SSZ
7		Rescue	Rescue	Rescue	Rescue	CYC
8						Rescue

CYC, ciclosporin.

**TABLE 55** Strategies modelled by AbbVie for analyses 4 and 5

Treatment number	Sequence number				
	1	2	3	4	5
1	SSZ + HCQ	ADA	ETN	CTZ	TCZ
2	LEF	LEF	LEF	LEF	LEF
3	SSZ	SSZ	SSZ	SSZ	SSZ
4	CYC	CYC	CYC	CYC	CYC
5	Rescue	Rescue	Rescue	Rescue	Rescue

CYC, ciclosporin.

**TABLE 56** Strategies modelled by AbbVie for analysis 6

Treatment number	Sequence number			
	1	2	3	4
1	SSZ + HCQ	ADA	ETN	SSZ + HCQ
2	LEF	LEF	LEF	ADA
3	SSZ	SSZ	SSZ	LEF
4	CYC	CYC	CYC	SSZ
5	Rescue	Rescue	Rescue	CYC
6				Rescue

CYC, ciclosporin.

**TABLE 57** Strategies modelled by Bristol-Myers Squibb for analyses 1 and 7

Sequences									
1	LEF	ABT i.v. + MTX	ABT s.c. + MTX	ADA + MTX	CTZ + MTX	ETN + MTX	GOL + MTX	IFX + MTX	TCZ + MTX
2	GLD	RTX + MTX <sup>a</sup>	RTX + MTX <sup>a</sup>	RTX + MTX <sup>a</sup>	RTX + MTX <sup>a</sup>	RTX + MTX <sup>a</sup>	RTX + MTX <sup>a</sup>	RTX + MTX <sup>a</sup>	RTX + MTX <sup>a</sup>
3	CYC	TCZ + MTX <sup>b</sup>	TCZ + MTX <sup>b</sup>	TCZ + MTX <sup>b</sup>	TCZ + MTX <sup>b</sup>	TCZ + MTX <sup>b</sup>	TCZ + MTX <sup>b</sup>	TCZ + MTX <sup>b</sup>	LEF
4	AZA	LEF	LEF	LEF	LEF	LEF	LEF	GLD	GLD
5	PC	GLD	GLD	GLD	GLD	GLD	GLD	CYC	CYC
6		CYC	CYC	CYC	CYC	CYC	CYC	AZA	AZA
7		AZA	AZA	AZA	AZA	AZA	AZA	PC	PC
8		PC	PC	PC	PC	PC	PC		

AZA, azathioprine; CYC, ciclosporin; PC, palliative care.  
a RTX is contradicted; a randomly sampled treatment not previously used was substituted.  
b It appears that TCZ + MTX would not be used if there was a DAS28 improvement of 1.2 or greater at 6 months.

If RTX was contraindicated, then a randomly sampled (and previously unused) bDMARD would be used instead.

From the model structure it appears that if there is a good response to RTX then TCZ would not be used as a third-line treatment option.

### Merck Sharp & Dohme Corp.

For brevity, the strategies for GOL and IFX have been discussed jointly as they are identical. The strategies employed in the MSD submissions are contained in *Table 58*. It is noted that these do not allow TCZ to be used as a third-line biologic as allowed within NICE guidance. MSD assumes that the first- and second-line treatment options have been used prior to the decision point. The Assessment Group comment that the use of RTX in the MTX arm is outside of licence as a bDMARD must have been provided prior to RTX.

All patients were assumed to have previous lines of MTX and SSZ plus MTX.

The other bDMARDs evaluated were ETN, ADA, CTZ, TCZ, ABT i.v. and ABT s.c.

**TABLE 58** Strategies modelled by MSD for analyses 1 and 7

Treatment number	IFX arm	GOL arm	Other biologic DMARD arm	MTX arm
1	IFX + MTX	GOL + MTX	Biologic DMARD + MTX	MTX
2	RTX	RTX	RTX	RTX
3	LEF	LEF	LEF	LEF
4	GLD	GLD	GLD	GLD
5	AZA	AZA	AZA	AZA
6	CYC	CYC	CYC	CYC
7	PC	PC	PC	PC

AZA, azathioprine; CYC, ciclosporin; PC, palliative care.

### Pfizer

The strategies employed in the Pfizer submission are contained in *Tables 59* and *60*. It is noted that the strategy with TCZ first does not follow NICE guidance in that ABT i.v. is used as a third-line treatment.

### Roche

Roche evaluated a very limited set of sequences, which consisted of inserting TCZ before a standard sequence of care. This is replicated in *Figure 30*. Roche evaluated only a sequence of MTX-intolerant or -contraindicated RA population. It is noted that Roche assumes that the standard of care sequence has three lines of bDMARD treatments (followed by palliative care), which is not in accordance with current NICE guidance. Roche evaluated only one sequence in which TCZ was inserted as the first-line treatment to create four lines of bDMARDs.

**TABLE 59** Strategies modelled by Pfizer for analyses 1–3

Treatment number	Sequences									
	1	2	3	4	5	6	7	8	9	10
1	ETN	ABT i.v.	ABT s.c.	CTZ	ADA	IFX	TCZ	GOL	cDMARD	Combination cDMARD
2	RTX	RTX	RTX	RTX	RTX	RTX	RTX	RTX	RTX	RTX
3	TCZ	TCZ	TCZ	TCZ	TCZ	TCZ	ABT i.v.	TCZ	TCZ	TCZ
4	SSZ	SSZ	SSZ	SSZ	SSZ	SSZ	SSZ	SSZ	SSZ	SSZ
5	LEF	LEF	LEF	LEF	LEF	LEF	LEF	LEF	LEF	LEF
6	PC	PC	PC	PC	PC	PC	PC	PC	PC	PC

**Treatment sequences applied by analysis**

Analysis 1	✓	✓	✓	✓	✓	✓	✓	✓	✓	
Analysis 2	✓								✓	
Analysis 3	✓								✓	✓

PC, palliative care.

TABLE 60 Strategies modelled by Pfizer for analysis 4

Treatment number	Sequences				
	1	2	3	4	5
1	ETN	ADA	TCZ	TCZ	cDMARD
2	ADA	ETN	ETN	ADA	ETN
3	SSZ	SSZ	SSZ	SSZ	SSZ
4	LEF	LEF	LEF	LEF	LEF
5	PC	PC	PC	PC	PC

PC, palliative care.

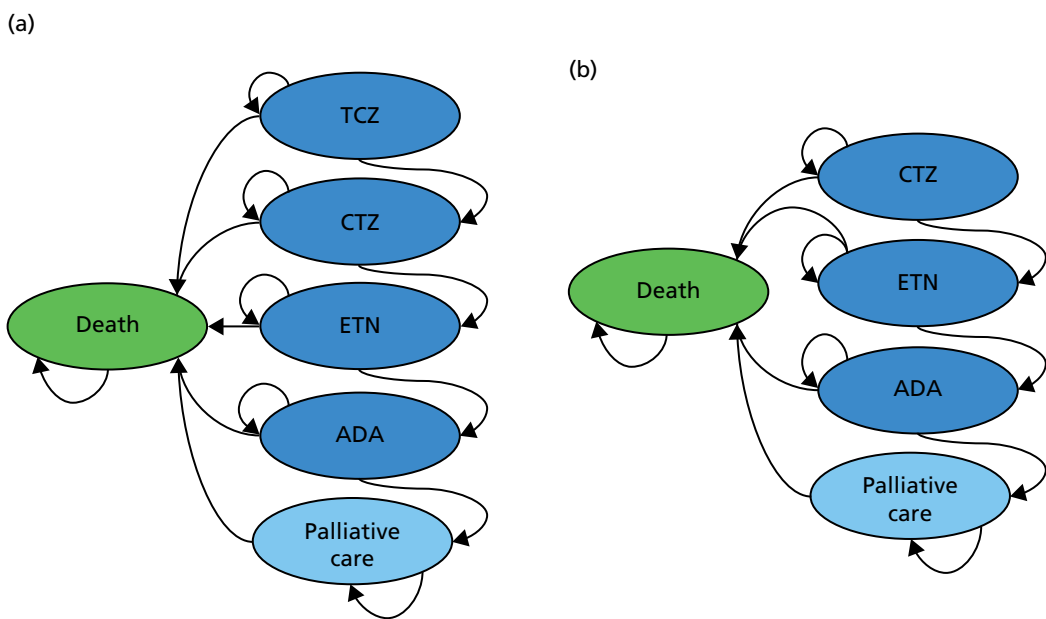


FIGURE 30 Strategies modelled by Roche for analysis 8. (a) TCZ sequence; and (b) standard of care sequence.



## UCB Pharma

The strategies modelled by UCB Pharma are given in *Table 61* and *62*. The Assessment Group notes that in the MTX-experienced populations with DAS > 5.1, the continuing use of cDMARDs was not a comparator strategy, which is a serious deviation from the published scope.

### Model structure/time cycle

This section details the model structure employed by each manufacturer. The two submissions from MSD have been assessed jointly as they have the same structure.

### Broad summary

Four individual patient models and two cohort models were submitted. Of the four individual patient-level models, three used discrete event simulation (DES) techniques, which do not need time cycles, with the remainder using a 6-month cycle. Of the two cohort models, one used a 6-month time cycle, whereas the other adopted this after the initial year, with either three cycles of 6, 3 and 3 months in the first year, or 3, 4.5 and 4.5 months depending on the user input. Both cohort models used a half-cycle correction.

Four of the models were constructed in Microsoft Excel (Microsoft Corporation, Redmond, WA, USA); one in Arena (Rockwell Automation, Milwaukee, WI, USA); and one in SIMUL8 (Simul8 Corporation, Boston, MA, USA).

**TABLE 61** Strategies modelled by UCB Pharma for analyses 1 and 4

Set-up	Interventions/regimens
Comparators	Combination with MTX
	CTZ
	ADA
	ETN
	GOL
	TCZ
	IFX
	ABT
	Monotherapies
	CTZ
	ADA
	ETN
	TCZ
	Follow-on interventions
AZA	
CYC	
GLD	
HCQ	
LEF	
Penicillamine	
Palliation	

AZA, azathioprine; CYC, ciclosporin.

TABLE 62 Strategies modelled by UCB Pharma for analyses 2 and 5

Set-up	Parameter
Comparators	CTZ + MTX
	CTZ + cDMARDs
	PBO + MTX
	PBO + cDMARDs
Follow-on interventions	MTX + SSZ
	MTX + SSZ + HCQ
	MTX + HCQ
	MTX + LEF
	SSZ + HCQ
	CYC
	Penicillamine
	Palliation

CYC, ciclosporin.

AbbVie

The model is an individual-patient simulation based within Arena run for a cohort of 1000 patients, each with specific baseline characteristics, which are sampled from distributions specified in an Excel input shell. One hundred and fifty replications are done for each analysis to create 150,000 patients per treatment sequence. The overview of the model logic is shown in Figure 31. The model uses a DES approach; thus, there are no time cycles, although all patients are assumed to stay on treatment for 6 months (unless an AE occurs).

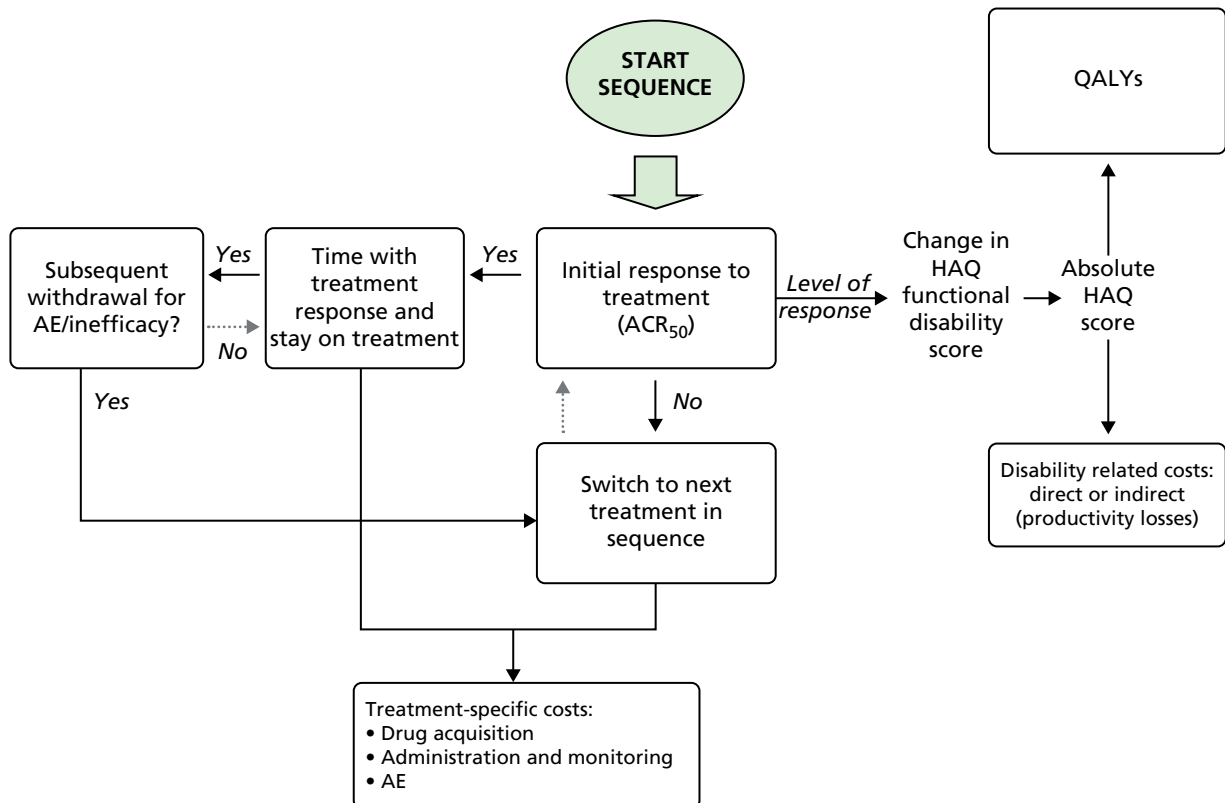


FIGURE 31 The AbbVie model structure.

### Bristol-Myers Squibb

Bristol-Myers Squibb reproduced the individual patient model built by Malottki *et al.*<sup>171</sup> but added first-line biologics to the beginning of the model. This was implemented in SIMUL8 and does not require time cycles. The model logic is shown in *Figure 32*.

### Merck Sharp & Dohme Corp.

A Markov model constructed in Excel was used to estimate the expected costs and QALYs of patients with RA. A time cycle of 6 months was used with half-cycle correction.

The model structure is depicted in *Figure 33*.

### Pfizer

The model was developed in Excel with visual basic for applications and uses a DES approach to model individual patients. As the model uses a DES approach, no time cycles were necessary.

Time on treatment and disease progression are time dependent, whereas modelling the effects of treatment withdrawal and any subsequent rebound effect requires knowledge of patients' disease status prior to treatment.

The model structure is summarised in *Figure 34* and is applicable to each decision problem evaluated.

### Roche

The manufacturer reports that the design of the economic analysis follows guidelines set by the Outcome Measures in Rheumatoid Arthritis Clinical Trials (OMERACT) Economics Working Group.<sup>212,213</sup>

The economic analysis is based on an individual patient model designed in Excel with the use of Visual Basic applications. The model tracks the characteristics of the individuals and maintains a history in particular of a patient's response to treatment in their assigned drug sequence and change in HAQ score over time.

The model algorithm is presented in *Box 2*.

The model implements a 6-month cycle length, which is in line with timing of available efficacy evidence (ACR data). Patients transition through the model by sequentially moving on to each treatment. Once patients exhaust all treatments in the sequence, they move into palliative care where they remain until death.

### UCB Pharma

The cost-effectiveness model is a Markov (cohort health state transition) structure constructed in Excel.

The first model cycle is either 3 or 6 months (12 or 24 weeks), depending on the definition of response selected in the model and reflective of the published clinical guidance [6 months (24 weeks) is used in the base case]. The model allows for clinical response to be measured by either ACR response criteria (developed by the ACR) or EULAR response criteria (developed by the EULAR).

Two further model cycles in the first year are common to both the severe and moderate disease activity populations. Where the first model cycle has been chosen to be 3 months, the subsequent two time steps are each 4.5 months long. Where the first model cycle has been chosen to be 6 months, the subsequent two time steps are each 3 months long. The maximum time step length in the model is 6 months.

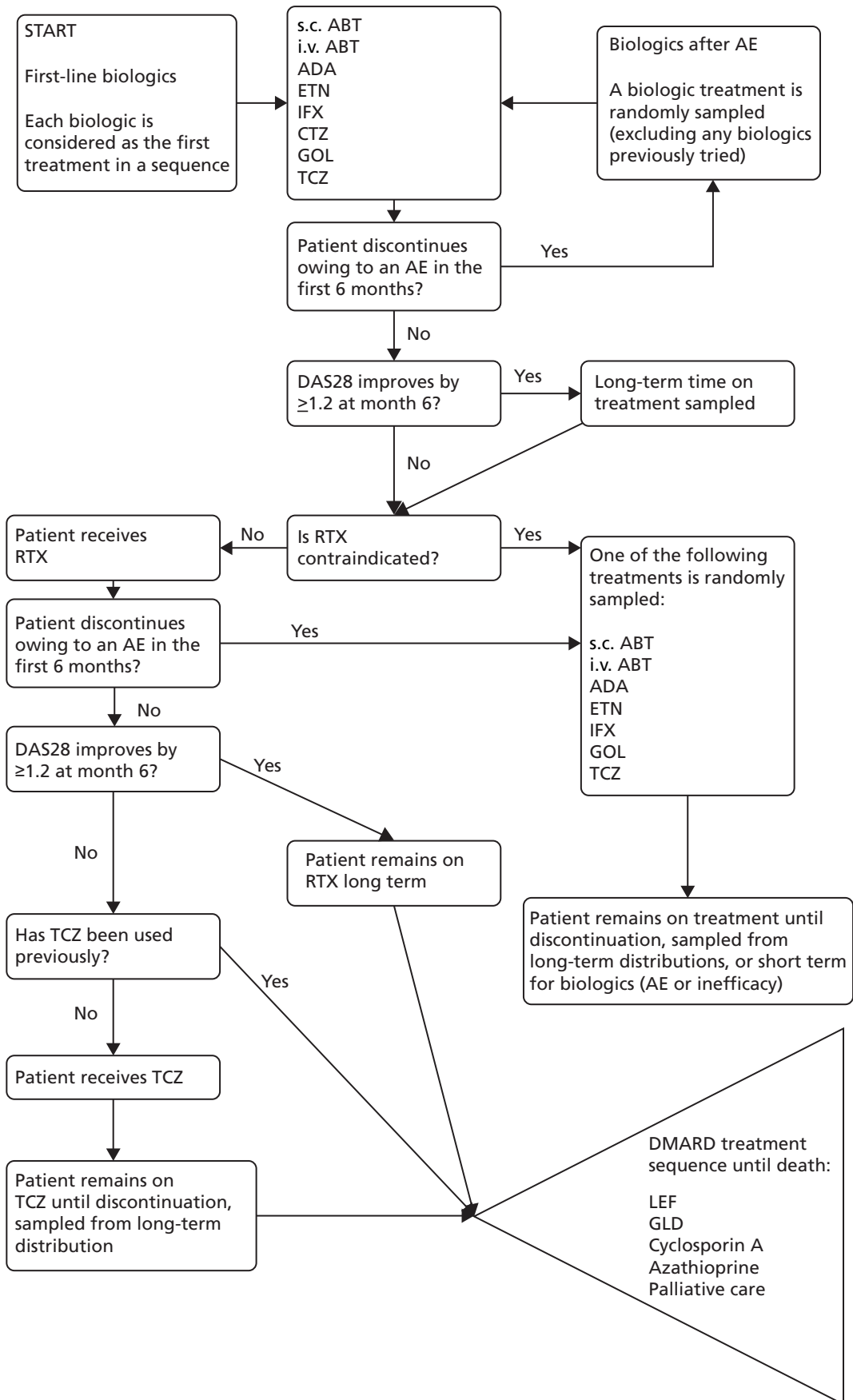


FIGURE 32 The Bristol-Myers Squibb model structure.

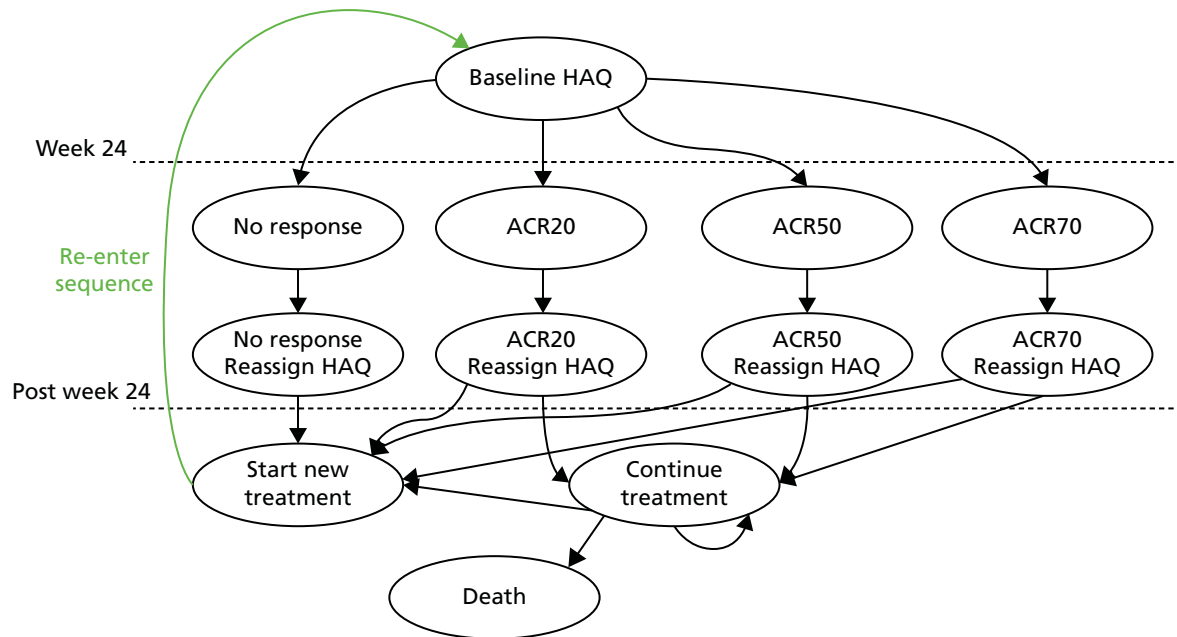


FIGURE 33 The MSD model structure.

FIGURE 34 The Pfizer model structure. (AiC information has been removed.)

**BOX 2** The individual simulation process reported by Roche

Start the simulation.

For patients  $i = 1, 2, \dots, n$ , cycles  $k = 1, 2, \dots, n$  a random number drawn by a continuous uniform distribution  $\theta \sim U[0, 1]$ , and the relevant risk factor  $p$ .

Determine the path of patient  $i$  through the model by  $\theta_{i,k} \leq p_k$

Determine cost  $c_i$  and utility  $u_i$  for individual  $i$ .

End the simulation.

Estimate the mean cost and utility  $E[(C, U)]$  by

$$\hat{a}_n = \frac{1}{n} \sum_{i=1}^n (c_i, u_i).$$

At the end of the next and following cycles, patients may remain in the same Markov state, discontinue treatment owing to an AE, discontinue treatment owing to lack of efficacy or intolerance, or die. There are no state transitions other than discontinuation of treatment and death. Discontinuation of treatment was assumed to be the same for all comparators, which was deemed to be a conservative assumption. Transition probabilities were calculated to appropriately reflect the varying length of time steps in the first model year. After the first 12 months, the cycle length is 6 months, reflecting the frequency of monitoring recommended by NICE and the British Society of Rheumatology. A half-cycle correction was employed.

The model structure based on ACR response is depicted in *Figure 35* and the model structure based on EULAR response is depicted in *Figure 36*.

### Time horizon

The time horizon for each model is detailed below. In summary, all models adopted a lifetime, or approximately lifetime, time horizon.

#### AbbVie

The AbbVie model used a lifetime horizon.

#### Bristol-Myers Squibb

The Bristol-Myers Squibb model used a lifetime horizon.

#### Merck Sharp & Dohme Corp.

The MSD model used a time horizon of 45 years, assuming that patients with moderate to severe RA would die at a maximum 95 years and those with severe RA would die at a maximum age of 96 years. Shorter analysis time frames were used in the sensitivity analyses.

#### Pfizer

The Pfizer model used a lifetime horizon. Shorter analysis timeframes were used in the sensitivity analyses.

#### Roche

The Bristol-Myers Squibb model used a lifetime horizon.

#### UCB Pharma

The time horizon in the base-case analysis was an approximation of the lifetime of a patient. UCB Pharma stated that analysis of BSRBR data has revealed an average age of patients starting on TNF inhibitors of 55 years.<sup>214</sup> A time frame of 45 years would assume that patients would die at a maximum age of 100 years. Shorter analysis timeframes were used in the sensitivity analyses.

### Perspective

The perspectives adopted in the submissions are detailed below. In summary, all submissions used an NHS and Personal Social Services perspective.

#### AbbVie

The base-case analysis of the economic evaluation was conducted from a NHS and Personal Social Services perspective. AbbVie note that resource use data related to Personal and Social Services for the management of RA in the UK were not available for costing purposes.

---

**FIGURE 35** Markov structure: severe disease activity population; model structure based on ACR response presented by UCB Pharma. (AiC information has been removed.)

---

**FIGURE 36** Markov structure: moderate disease activity population; model structure based on EULAR response presented by UCB Pharma. (AiC information has been removed.)

### Bristol-Myers Squibb

Although not explicitly stated, the Bristol-Myers Squibb model adopts a NHS and Personal Social Services perspective.

### Merck Sharp & Dohme Corp.

The MSD analysis is conducted from the UK NHS perspective. Direct costs included the drug cost, administration cost and health-care resource use.

### Pfizer

The current analysis was conducted from the perspective of the UK NHS and Personal Social Services.

### Roche

The Roche submission used an NHS and Personal Social Services perspective.

### UCB Pharma

The model takes a payer perspective (i.e. that of the NHS and Personal Social Services), as per NICE guidance, and includes direct medical costs such as hospital care (inpatient and outpatient), primary care and home visits. Sensitivity analyses were conducted using a societal perspective.

### Discounting

The discount rates used within the submissions are shown in *Table 63*. In summary, each submission used the appropriate discount rate in the base-case analysis.

### Population characteristics

The population characteristics for each submission are detailed in this section. In summary, the manufacturers often use drug-specific data from the BSRBR, or from the trials related to their intervention. Typically no comment is made regarding the correlation between parameters with the exception of Pfizer's model.

**TABLE 63** The discount rates used per annum within the submissions

Manufacturer	Base case		Sensitivity analyses	
	Costs	QALYs	Costs	QALYs
AbbVie	3.5%	3.5%	6.0%	1.5%
			1.5%	1.5%
Bristol-Myers Squibb MSD	3.5%	3.5%	0.0%	3.5%
			3.5%	0.0%
			0.0%	0.0%
Pfizer	3.5%	3.5%	6.0%	1.5%
Roche	3.5%	3.5%		
UCB Pharma	3.5%	3.5%	6.0%	1.5%
			1.5%	6.0%
			1.5%	1.5%
			6.0%	6.0%

## AbbVie

The baseline characteristics for patients considered within the AbbVie analyses come from different sources, of which it was stated that wherever possible the source was chosen to reflect the composition of the treated population for RA in the UK. For MTX-experienced patients with moderate disease activity the source was the ReAct study.<sup>215</sup> Data from the BSRBR for this patient population could not be used, because historically patients in the UK have always required a DAS28 of > 5.1 to receive an antiTNF; as such, any patients in the BSRBR with a DAS28 of < 5.1 who received an antiTNF are very select group of patients with non-normal characteristics. For MTX-experienced patients with severe disease activity the source was the BSRBR data. AbbVie report that analysis was undertaken on BSRBR data for ADA from the raw BSRBR. This analysis was presented as AiC data. For MTX-naive patients with severe disease activity the source was the PREMIER trial.<sup>109</sup> The characteristics of patients for each of those populations are outlined in *Tables 64–66*. No comment is made on the correlation of parameters.

For each subpopulation several sensitivity analyses were conducted, to take into account the effect in the cost-effectiveness estimates of applying the sequences to a fully male or fully female population; a population with average starting age of 55 years or 65 years; a population with average baseline HAQ score of 1.0, 1.5 or 2.0. There is no comment on the correlation assumed between the distributions.

**TABLE 64** The baseline patient characteristics for MTX-experienced patients with moderate disease activity assumed by AbbVie

Patient characteristic	Value (SD)
Sex (% female)	81.4
Age (years)	54.6
Baseline HAQ-DI	1.5 (0.65)
Disease duration (years)	10.65 (8.56)
All sources: Burmester <i>et al.</i> , 2007. <sup>215</sup>	

**TABLE 65** The baseline patient characteristics for MTX-experienced patients with severe disease activity assumed by AbbVie

Patient characteristic	Value (SD)
Sex (% female)	AiC information has been removed
Age (years) (males/females)	AiC information has been removed
Baseline HAQ-DI (males/females)	AiC information has been removed
Disease duration (years)	AiC information has been removed
All sources: AbbVie analysis of BSRBR data.	

**TABLE 66** The baseline patient characteristics for MTX-naive patients with severe disease activity assumed by AbbVie

Patient characteristic	Value (SD)
Sex (% female)	75.0
Age (years) (males/females)	60.8/58.0
Baseline HAQ-DI (males/females)	1.38 (0.62)/1.58 (0.65)
Disease duration (years)	11.28 (9.07)
All sources: Breedveld <i>et al.</i> , 2006. <sup>109</sup>	



### Bristol-Myers Squibb

The Bristol-Myers Squibb patient-level simulation model generates a group of virtual patients, who are assigned individual characteristics, such that each patient has their own sex, age and HAQ score. These values were taken from Chen *et al.*,<sup>123</sup> and are reproduced in *Tables 67* and *68*. It is not commented whether or not the age and sex distributions are assumed to be correlated with HAQ distribution.

It is commented that the mean of the assumed duration is a HAQ of 1.22.

### Merck Sharp & Dohme Corp.: golimumab

It is reported that the base-case analysis reflects the GO-FORWARD<sup>216</sup> population and the subgroup analysis reflects the severe patient group (DAS of > 5.1) from GO-FORWARD.<sup>92</sup> No comment is made on the correlation between parameters.

### Merck Sharp & Dohme Corp.: infliximab

It is reported that the base-case analysis reflects the Anti-TNF trial in Rheumatoid Arthritis with Concomitant Therapy (ATTRACT)<sup>75</sup> population and the subgroup analysis reflects the severe patient group (DAS28 of > 5.1) from ATTRACT. No comment is made on the correlation between parameters.

### Pfizer

Patients used in the Pfizer model are subdivided into three groups: severe DMARD-inadequate responders; moderate to severe inadequate responders; and severe naïve patients. The following text is taken largely from the Pfizer submission.

#### *Severe disease-modifying antirheumatic drug-inadequate responders*

Characteristics of individual patients in the severe DMARD-inadequate responder population were sampled (with replacement) directly from the baseline ETN BSRBR patient cohort (*Table 69*). This method has the advantage of maintaining correlation between variables without reliance on strong distributional assumptions, such as multivariate normality, or complex copula-based processes to specify arbitrary marginal distributions. *Table 69* presents a summary of the population characteristics assumed within the model for all populations.

#### *Moderate to severe disease-modifying antirheumatic drug-inadequate responders*

The ETN BSRBR cohort with DAS of  $\leq 5.1$  was not considered sufficiently generalisable to the moderate to severe population. Patient characteristics for the moderate to severe population were simulated using summary statistics from PRESERVE,<sup>217</sup> with the correlation structure taken from the BSRBR ( $n = 3780$ ). The implicit assumption is that the correlation between variables in these two populations is the same. The population was generated with no restrictions on DAS, and then an acceptance–rejection algorithm was used to redraw characteristics for patients in whom the simulated DAS28 was outside the 3.2–5.1 range or who had a simulated age of < 18 years. This avoided any artificial truncation caused by, for example, assuming all patients simulated with a DAS28 of < 3.2 had a DAS28 = 3.2 and preserved the correlation between variables.

**TABLE 67** Age and sex distributions of patients in the Bristol-Myers Squibb model

Sex	Age (years)							Total
	15–24	25–34	35–44	45–54	55–64	65–74	75–84	
Male	0.9%	2.5%	5.4%	8.3%	9.0%	6.8%	5.1%	38%
Female	1.5%	4.0%	8.8%	13.7%	14.7%	10.9%	8.4%	62%



### *Severe disease-modifying antirheumatic drug-naïve patients*

Patients within the ETN BSRBR cohort enter the registry within the context of current clinical practice. As current clinical guidance from NICE does not permit the use of bDMARDs before the failure of two conventional DMARDs, the ETN BSRBR cohort does not contain a patient population generalisable to the severe DMARD-naïve population. In order to generate this cohort, characteristics were sampled using summary statistics from Combination Of METHotrexate and etabercept in early rheumatoid arthritis (COMET),<sup>81</sup> assuming the correlation structure from the ETN BSRBR cohort. The simulation of patients used acceptance/rejection criteria as described for moderate to severe DMARD-inadequate responders in order to ensure all patients had a DAS28 of > 5.1 and were aged  $\geq 18$  years.

### Roche

Roche report that the modelled patient population is consistent with both the drug licence and populations from TCZ and comparator Phase III trials. The population comprises moderate to severe RA patients who have had an inadequate response to one or more cDMARDs, and who are intolerant or contraindicated to MTX.

All baseline characteristics in the model are taken from the Phase IV ADACTA study,<sup>58</sup> with the exception of the average patient weight. The average patient weight in the ADACTA study<sup>58</sup> was 77 kg, significantly higher than previous estimates for the UK population.

Therefore, Roche used the 70 kg weight previously accepted in NICE TAs (TA130,<sup>207</sup> TA195<sup>28</sup> and TA247<sup>26</sup>). The Assessment Group comment that the assumed lower weight assumed by Roche is likely to underestimate the costs of TCZ, as a person weighing 70 kg requires a 400-mg and a 200-mg vial, whereas a person weighing 77 kg would require an additional 80-mg vial.

A summary of the patient characteristic data assumed by Roche is provided in *Table 70*. No comment is made on the correlation of the parameters.

### UCB Pharma

UCB Pharma simulated patients with RA and a moderate or severe disease activity who have had an inadequate response to MTX. The cost-effectiveness of CTZ versus alternative treatments was evaluated separately for the moderate and severe disease activity populations.

Baseline characteristics of the severe RA population and the moderate to severe RA population were based on mean estimates from the CRZ trials, which were assumed to reflect the population eligible for treatment with CTZ in clinical practice (*Table 71*). Baseline characteristics for the severe disease activity population were based on the pooled estimates from the Rheumatoid Arthritis Prevention of structural Damage (RAPID)1,<sup>135</sup> RAPID2<sup>136</sup> and FAST4WARD<sup>218</sup> studies (including both the CTZ and PBO treatment arms). Baseline characteristics for the moderate disease activity population were based on estimates from the CERTAIN<sup>79</sup> study (including both the CTZ and PBO treatment arms). Some data were presented as AiC. No comment is made on the correlation between parameters.

**TABLE 70** The patient characteristic data assumed by Roche

Parameter	Value	Source
Sex: female, %	79	ADACTA <sup>58</sup>
Mean age (years)	53.8	ADACTA <sup>58</sup>
Starting HAQ score	1.65	ADACTA <sup>58</sup>
Mean weight (kg)	70	Previous NICE appraisals <sup>26,28,207</sup>

**TABLE 71** The baseline characteristics of the modelled population assumed by UCB Pharma

AiC information has been removed	AiC information has been removed	AiC information has been removed
AiC information has been removed	AiC information has been removed	AiC information has been removed
AiC information has been removed	AiC information has been removed	AiC information has been removed
AiC information has been removed	AiC information has been removed	AiC information has been removed
AiC information has been removed	AiC information has been removed	AiC information has been removed
AiC information has been removed	AiC information has been removed	AiC information has been removed
AiC information has been removed	AiC information has been removed	AiC information has been removed
AiC information has been removed	AiC information has been removed	AiC information has been removed

### *The assumed costs of the interventions*

This section details the costs assumed by each manufacturer; administration and monitoring costs are included in a separate section. In summary, the costs seem appropriate apart from the following points: AbbVie does not consider current PASs; Bristol-Myers Squibb and Roche assume that all patients weigh 70 kg, which is likely to underestimate the costs for weight-based dosages (bar GOL); neither Pfizer nor UCB Pharma includes PASs for TCZ or ABT as these are commercial-in-confidence (CiC); MSD does not include the PAS for ABT.

All manufacturers assumed vial wastage for ABT i.v., TCZ and IFX, although Roche discuss that where the appropriate dose is only marginally above that produced by a combination of vials a clinician may opt not to open a new vial.

Both Roche and UCB Pharma assume that it is possible for treatment to be discontinued after 3 months rather than 6 months through lack of efficacy.

### **AbbVie**

The cost of all drugs used in the AbbVie analyses was calculated based on the recommended dosages and vial prices given in the Monthly Index of Medical Specialties 2013.<sup>219</sup> Importantly, the impact to the NHS of PASs on the cost of certain drugs was not taken into account in the analysis. AbbVie cited the NICE Methods Guide,<sup>220</sup> which states that PAS are valid until NICE TA review, at which point manufacturers will need to agree a new PAS (even if it remains constant) for the appraisal review. As such, it is not known if all the current PASs in existence will be agreed again by the PAS's Liaison Unit and this is why they have not been included in the analysis. No sensitivity analyses were conducted using existing PASs. This is unfavourable to CTZ, as the initial 10 doses are provided free; ABT and TCZ, for which AiC discounts are provided; and GOL who provide the 100-mg dose of GOL at the same price as the 50-mg dose.

AbbVie provides detailed breakdown of all conventional DMARDs and biologic treatments and does take patient weight into consideration. ABT s.c. is not considered. The cost per dose for biologic treatments assumed by AbbVie is reproduced in *Table 72*.

For interventions that are weight dependent, AbbVie examined the weight distribution of patients enrolled in the BSRBR from the ADA cohort ( $n = 4364$  patients) to determine the most likely average annual drug acquisition cost of TCZ, ABT, INF and GOL in the UK.

*Tables 73–76* show the calculations undertaken by AbbVie to establish average cost per dose.

**TABLE 72** The costs of bDMARDs assumed by AbbVie

Treatment	Dose regimen	Cost per dose (£)
ADA	40 mg; every other week	352.14
ETN	50 mg; every week	178.75
IFX	3 mg/kg; at 0, 2 and 6 weeks, then every 8 weeks	1133.28
ABT	500 mg if weight is below 60 kg, 750 mg if weight is between 60 kg and 100 kg, 1000 mg if weight is above 100 kg; at 0, 2 and 4 weeks, then every 4 weeks thereafter	856.27
RTX	1000 mg followed by 1000 mg 2 weeks later; repeated every 9 months	1746.30
GOL	50 mg if weight is below 100 kg, 100 mg if weight is above 100 kg, per month	832.09
TCZ	8 mg/kg every 4 weeks	782.67
CTZ	400 mg; repeated 2 weeks and 4 weeks after initial injection	715.00
CTZ	200 mg; repeated every 2 weeks thereafter	357.50

**TABLE 73** The calculation undertaken by AbbVie to establish the average expected cost per TCZ treatment

Possible combinations of TCZ vials (mg)	Total dose (mg)	Lower weight (kg)	Upper weight (kg)	Cost per dose (£)	% patients in BSRBR	Annual cost (£)
80 + 80 + 80	240	–	30	307.20	0.05	3993.60
200 + 80	280	31	35	358.40	0.18	4659.20
200 + 80 + 80	360	36	45	460.80	1.67	5990.40
400	400	46	50	512.00	3.94	6656.00
400 + 80	480	51	60	614.40	18.42	7987.20
400 + 80 + 80	560	61	70	716.80	23.97	9318.40
400 + 200	600	71	75	768.00	11.07	9984.00
400 + 200 + 80	680	76	85	870.40	17.42	11,315.20
400 + 200 + 80 + 80	760	86	95	972.80	11.73	12,646.40
400 + 400	800	96	–	1024.00	11.55	13,312.00
Average cost per dose				782.67		
Average cost per year (13 doses)						10,174.65

**TABLE 74** The calculation undertaken by AbbVie to establish the average expected cost per ABT treatment

Number of vials	Lower weight (kg)	Upper weight (kg)	Cost per dose (£)	% patients in BSRBR	Annual cost (first year) (£)	Annual cost (second year and beyond) (£)
Two	–	60	604.80	24.27	8467.20	7862.40
Three	61	100	907.20	68.31	12,700.80	11,793.60
Four	36	45	1209.60	7.42	16,934.40	15,724.80
Average cost per dose			856.27			
Average cost per year (14 doses in the first year, 13 doses for second year and beyond)					11,987.76	11,131.49

**TABLE 75** The calculation undertaken by AbbVie to establish the average expected cost per IFX treatment

Number of vials	Lower weight (kg)	Upper weight (kg)	Cost per dose (£)	% patients in BSRBR	Annual cost (first year) (£)	Annual cost (second year and beyond) (£)
One	–	33	419.62	0.14	3356.96	2727.53
Two	34	66	839.24	38.13	6713.92	5455.06
Three	67	99	1258.86	54.31	10,070.88	8182.59
Four	100	133	1678.48	6.58	13,427.84	10,910.12
Five	134	166	2098.10	0.64	16,784.80	13,637.65
Six	167	–	2517.72	0.21	20,141.76	16,365.18
Average cost per dose			1133.28			
Average cost per year (8 doses in the first year, 6.5 doses on average for second year and beyond)					9066.25	7366.33

**TABLE 76** The calculation undertaken by AbbVie to establish the average expected cost per GOL treatment

Number of pens	Lower weight (kg)	Upper weight (kg)	Cost per dose (£)	% patients in BSRBR	Annual cost (£)
One	–	100	774.58	92.58	9294.96
Two	101	–	1549.16	7.42	18,589.92
Average cost per dose			832.09		
Average cost per year (12 doses) <sup>a</sup>					11,649.23

<sup>a</sup> This calculation was performed by AbbVie and does not look correct. However, this value was not used in the model.

### Bristol-Myers Squibb

Bristol-Myers Squibb estimates the yearly costs of each intervention and additional costs incurred in the first year due to loading doses. Bristol-Myers Squibb assumes that all patients weigh 70 kg, the lack of uncertainty in this value will likely favour those interventions that are weight based, and in particular TCZ. Bristol-Myers Squibb considers PAS in place at the start of the appraisal, two of which, for TCZ and for both ABT formulations, are CiC. The bDMARDs costs assumed by Bristol-Myers Squibb are replicated in *Table 77*.

### Merck Sharp & Dohme Corp.

Merck Sharp & Dohme Corp. has distinguished between the costs in the first 6 months, when loading doses may be needed, and costs in subsequent 6-month cycles. These are replicated in *Table 78*. The PAS for CTZ and GOL have been applied, but neither the TCZ nor the ABT PAS (which are CiC) is used.

The costs for weight-based doses were calculated based on the weight distributions of 2775 IFX patients within the BSRBR database to estimate the average number of *full* vials that are used per patient (or in the case of TCZ the weighted-average cost per patient). These data are shown in *Table 79*. The Assessment Group notes that the TCZ costs are inaccurate, as a patient weighing between 46 kg and 50 kg would be most inexpensively treated with a 400-mg vial alone, an option not considered.

**TABLE 77** The intervention costs assumed by Bristol-Myers Squibb

Treatment	Annual cost (£)	Year 1 start-up cost (£)
ABT i.v.	CiC information has been removed	CiC information has been removed
ABT s.c.	CiC information has been removed	(CiC information has been removed)
ADA	9187	0
ETN	9327	0
IFX	8211	1259
TCZ	CiC information has been removed	CiC information has been removed
GOL	9156	0
CTZ	9327	-2503 <sup>a</sup>
RTX	4817	0
LEF	747	0
GLD	135	225
CYC	1685	0
AZA	98	0
MTX	18	0

AZA, azathioprine; CYC, ciclosporin.

a The year 1 additional cost for CTZ is negative owing to the free doses in the PAS. However, patients receive CTZ for a minimum of 6 months, so the cost is always positive.

**TABLE 78** The intervention costs assumed by MSD

Intervention	Cost per dose (£)	Number of doses per first 6 months	Number of doses post 6 months	Treatment cost first 6 months (£)	Treatment cost post 6 months (£)
GOL	762.97	6	6	4577.82	4577.82
ADA	352.14	13	13	4577.82	4577.82
IFX <sup>a</sup>	1133.20	5	3.25	5666.00	3682.90
ETN	89.38	52	52	4647.76	4647.76
TCZ <sup>b</sup>	698.32	7	6.5	4888.24	4539.08
CTZ <sup>c</sup>	357.50	6	13	2145.00	4647.50
LEF	1.88	205	178	385.40	334.64
GLD	13.48	26	26	350.48	350.48
AZA	0.07	547.5	547.5	38.33	38.33
CYC	2.14	365	365	781.10	781.10
MTX	0.05	78	78	3.90	3.90
ABT i.v. <sup>d</sup>	864.92	8	6.5	6919.35	5621.97
ABT s.c. <sup>e</sup>	302.40	26	26	8727.32	7862.40
RTX	1746.30	2	1.3	3492.60	2270.19

AZA, azathioprine; CYC, ciclosporin.

a Average of 2.70 vials with wastage.

b Average cost per infusion was £887.32 with wastage.

c Includes PAS.

d Includes average of 2.86 vials with wastage.

e Includes i.v. loading dose.

TABLE 79 The number of vials assumed by MSD for weight based interventions

Category	0–33 kg	34–59 kg	60–66 kg	67–100 kg	101–133 kg	> 134 kg (maximum weight 174 kg)	Total
Number in each IFX weight group	2	574	465	1546	176	12	2775
Percentage in each group	0.07	20.68	16.76	55.71	6.34	0.43	100
IFX vials per group (3 mg/kg)	1	2	2	3	4	6	–
ABT i.v. vials per group	2	2	3	3	4	4	–
TCZ vials per group (8 mg/kg)	200 mg + 80 mg	400 mg + 80 mg	400 mg + 400 mg + 80 mg	400 mg + 400 mg	400 mg + 400 mg	400 mg + 400 mg	–
Cost per patient per weight group (£)	358.40	614.40	716.80	1024.00	1024.00	1024.00	–
Weighted average IFX vials per infusion:	2.70						
Weighted average ABT i.v. vials per infusion:	2.86						
Weighted average TCZ cost per infusion:	£887.32						



As an example, the calculation for the weighted-average vials of IFX is as follows:

$$(0.07\% \times 1) + (20.68\% \times 2) + (16.76\% \times 2) + (55.71\% \times 3) + (6.34\% \times 4) + (0.43\% \times 6) = 2.70. \quad (16)$$

### Pfizer

Drug costs in the Pfizer submission were taken from publicly available sources, including PASs for CTZ and GOL. PASs which are not in the public domain, such as those for TCZ, ABT i.v. and ABT s.c., were not included.

For therapies administered based on the individual's weight, costs were calculated for each patient individually, and vial wastage was permitted.

Palliative care was assumed to consist of a combination of MTX, LEF and ciclosporin. This was assumed to represent a proxy for the cost of treatment in this line of therapy given the heterogeneous nature of treatments that are likely to be given at this stage, in order to try to control disease progression. Costs at this line of therapy are likely to be extremely heterogeneous and no accurate cost estimate was available; however, given that patients reach palliative care after several lines of therapy, potentially taking many years, the effect of discounting will be to make this assumption less influential.

Where applicable [in, for example, the severe DMARD-inadequate responder (monotherapy) population], the cost of the generic 'cDMARD' therapy was assumed to have the cost of MTX. Again, the cost was intended to act as a proxy for a generic therapy of this class in the absence of a definitive patient pathway. This is likely to be a conservative estimation given that MTX is the one of the cheapest cDMARDs available. A summary of the drug costs with dosing assumptions is provided in *Table 80*.

### Roche

The Roche submission considered only the use of TCZ in patients who are intolerant or contraindicated to MTX. It was assumed that all patients weigh 70 kg, although this was altered to 65 kg and 75 kg in sensitivity analyses. *Table 81* presents the costs assumed by Roche, although it is noted that this table does not include the PAS for TCZ that is used within the mathematical model. It is commented that it has been assumed that non-responders would be removed from treatment at 3 months, which may underestimate the acquisition costs of treatments.

### UCB Pharma

The costs of drug acquisition were based on the recommended dosing schedules for treatment multiplied by the unit cost of treatment as reported in the *British National Formulary* 64.<sup>30</sup> The PASs for CTZ and GOL were included but the CiC PASs for ABT and TCZ were not incorporated.

For i.v. drugs that are administered based on body weight [ATB, INF, TCZ, azathioprine (AZA) and ciclosporin (CYC)], the weight distribution of patients enrolled in either the RAPID1,<sup>135</sup> RAPID2<sup>136</sup> and FAST4WARD<sup>218</sup> trials (severe disease activity population) or the CERTAIN<sup>79</sup> study (moderate disease activity population) was applied to estimate the number of vials used.

**TABLE 80** The intervention costs assumed by Pfizer

Treatment	Dosing assumptions	Unit cost (£) <sup>a</sup>	Unit dose (mg)
ABT i.v.	Body weight ≤ 60 kg, 500 mg; 61–100 kg, 750 mg; > 100 kg, 100 mg; repeated 2 weeks and 4 weeks after initial infusion, then every 4 weeks	302.40	250
ADA	40 mg every other week	352.14	40
CTZ	400 mg at 0, 2 and 4 weeks then 200 mg every 2 weeks (PAS 10 for free)	357.50	200
CIC	Maximum of 4 mg/kg daily in two divided doses	51.50	3000
ETN	25 mg BIW	89.38	25
ABT s.c.	Loading dose by i.v. initially, then first 125-mg s.c. injection given within a day, followed by 125-mg s.c. OW	302.40 <sup>b</sup>	125
GOL	50 mg every 4 weeks	762.97	50
INF	3 mg/kg at weeks 0, 2 and 6, thereafter every 8 weeks	419.62	100
LEF	Assumed 20 mg OD	61.36	600
MTX	15 mg OW	48.44	1000
PC	Assumed to be additive combination of MTX, LEF, CIC (oral)	N/A	N/A
RTX	1000 mg repeated 2 weeks after initial infusion = one course; each course 9 months apart	873.15	500
SSZ	2000 mg/day	14.83	56,000
TCZ	8 mg/kg every 4 weeks	102.40	80
Combination therapy with cDMARDs	Assumed to be additive combination of MTX and SUL	N/A	N/A

BIW, twice weekly; CIC, ciclosporin; N/A, not applicable; OD, once daily; OW, once weekly; PC, palliative care.

a *British National Formulary* 64.<sup>221</sup>

b *British National Formulary* 2013.<sup>222</sup>

**TABLE 81** The intervention costs assumed by Roche

Treatment	Dose regimen <sup>a</sup>	Unit cost <sup>b</sup>	Cost for first 6 months (£)		Cost per subsequent cycle (£)
			Non-responders	Responders	Responders
ADA	40 mg every 2 weeks	£352.14 per 40-mg vial	2289	4578	4578
CTZ	200 mg every 2 weeks	£357.50 per 200-mg syringe	0	2324	4646
ETA	50 mg every week	£178.75 per 50-mg syringe	2324	4648	4648
TCZ	8 mg/kg every 4 weeks	£1.28 per mg	2330	4659	4659

a Source for dose regimen: *The Electronic Medicines Compendium*, 2011.<sup>223</sup>

b Source for unit cost: *British National Formulary* 2011. (Details not provided by Roche.)

For drugs that require loading doses or irregular administration, various assumptions were made to estimate the dose received by patients during the first and subsequent 6 months of treatment:

- For ABT, it was assumed that, during the first 6 months, treatment was administered at weeks 0, 2, 4, 8, 12, 16, 20 and 24, equating to eight administrations. During the subsequent 6 months, it was assumed that administrations occurred at a frequency of every 4 weeks, equating to 6.5 administrations over a 26-week cycle.
- For INF, similar assumptions were made when estimating dosing, where treatment was administered at weeks 0, 2, 6, 14, and 22 during the first 6 months, and an average of 3.25 administrations during any subsequent 6-month period.
- For CTZ, treatment was administered at weeks 0, 2 and 4 during the first month of treatment, with further doses administered every 2 weeks on a continuous basis until cessation.

A summary of the acquisition costs assumed by UCB Pharma is provided in *Table 82*.

### Administration and monitoring costs

This section details the administration and monitoring costs assumed within the manufacturers' submission. Many submissions provide detailed descriptions with multiple tables to support the monitoring costs used. These have been abridged within this summary for brevity. In summary, the monitoring costs are broadly comparable and are unlikely to have a big impact on the conclusions of the cost-effectiveness analyses. The costs of infusion were typically between £100 and £200 per infusion in the submissions, although AbbVie uses a value of £501 per infusion. Some submissions have costs associated with s.c. injections.

**TABLE 82** The intervention costs assumed by UCB Pharma

Treatment	Acquisition costs (£)	
	First 6 months	Every 6 months thereafter
<b>Combination treatments with MTX (severe disease activity population)</b>		
CTZ + MTX	2163	4666
ABT i.v. + MTX	7005	5695
IFX + MTX	5648	3677
TCZ + MTX	6475	6475
ADA + MTX	4596	4596
ETN + MTX	4666	4666
GOL + MTX	4596	4596
<b>Monotherapies (severe disease activity population)</b>		
CTZ	2145	4648
TCZ	6457	6457
ADA	4578	4578
ETN	4648	4648
<b>Combination treatments (moderate disease activity population)</b>		
CTZ + MTX	2163	4666
CTZ + cDMARDs	2255	4758
PBO + MTX	18	18
PBO + cDMARDs	111	111

It is commented that in a recent NICE review (TA247<sup>26</sup>) the Appraisal Committee agreed that the value of £154 per infusion was 'acceptable'. No comment was made on the manufacturer's assumption that 10% of s.c. injections would require administration by a district nurse.

### AbbVie

Administration costs of £501.48 were assumed in the AbbVie submission for each i.v. treatment, using data from NHS reference costs<sup>224</sup> and weighting the unit cost per day case admission (91%) and outpatient admission (9%) by activity levels. This assumption is based on the approach used in the NICE guidance for the use of IFX for treatment of adults with psoriasis.<sup>225</sup> An administration cost of £416.12 corresponding to the cost of an outpatient visit was tested in the scenario analysis.<sup>226</sup>

Monitoring requirements have been modelled based on UK practice based on share care guidelines and monitoring protocols for rheumatology patients in Bradford teaching hospitals<sup>226</sup> (Table 83) and validated by clinical experts prior to the previous NICE submission. Monitoring costs were not applied for ABT, INF, RTX or TCZ to avoid double-counting as 91% of patients are assumed to be admitted as a day case at each administration and the laboratory tests are included in the tariff. The monitoring requirements are, however, presented in Table 84 for completeness.

**TABLE 83** Monitoring costs assumed by AbbVie in the first 6 months

Test	Unit cost (£)	MTX/MTX + HCQ + SSZ	SSZ/LEF	CIC	HCQ	ADA/ETN/CTZ/GOL/ monotherapy or combination with MTX	Rescue
CXR	29.33	1	0	0	0	1	0
FBC	3.39	8	8	9	1	9	0
U&E	6.36	8	8	9	1	9	0
LFT	8.91	8	8	9	1	9	0
CRP	8.49	8	8	9	1	8	0
Urinalysis	7.84	0	0	1	0	1	0
Mantoux test	16.34	0	0	0	0	1	0
Hepatitis serology	7.84	0	0	0	0	1	0
ANA	8.49	0	0	0	0	3	0
DNA	8.49	0	0	0	0	1	0
Uric acid	1.27	0	0	3	0	0	0
Lipids	3.82	0	0	3	0	0	0
GP visit	36.36	3	3	3	0	3	0
Outpatient visit	132.75	5	5	6	1	6	3
Total		1019.36	990.03	1173.04	159.9	1236.75	398.25

ANA, antinuclear antibody; CIC, ciclosporin; CXR, chest radiography; DNA, deoxyribonucleic acid; FBC, full blood count; GP, general practitioner; LFT, liver function test; U&E, urea and electrolytes.

Sources: Bradford teaching hospitals July 2010,<sup>226</sup> NHS, 2013,<sup>224</sup> NICE, 2013,<sup>227</sup> Curtis, 2011.<sup>228</sup>

**TABLE 84** Annual monitoring costs assumed by AbbVie after the first 6 months

Test	Unit cost (£)	MTX/LEF, SSZ/MTX + HCQ + SSZ	ADA/ETN/CTZ/GOL/ monotherapy or combination	CIC	HCQ	Rescue
CXR	29.33	0	0	0	0	0
FBC	3.39	4	4	4	2	0
U&E	6.36	4	4	4	2	0
LFT	8.91	4	4	4	2	0
CRP	8.49	4	4	4	2	0
ANA	8.49	0	4	0	0	0
Uric acid	1.27	0	0	4	0	0
Lipids	3.82	0	0	4	0	0
GP visit	36.36	2	2	2	1	0
Outpatient visit	132.75	2	2	2	1	6
Total		446.82	480.78	467.18	223.41	796.5

ANA, antinuclear antibody; CXR, chest X-ray; CIC, ciclosporin; FBC, full blood count; GP, general practitioner; LFT, liver function test; U&E, urea and electrolytes.

Sources: Bradford Teaching Hospitals NHS Trust, 2010,<sup>226</sup> NICE, 2013,<sup>227</sup> Curtis, 2011.<sup>228</sup>

Data are shown to the level of accuracy available in the source material.

In the model, costs of monitoring/lab tests required at baseline are applied once the patients start the treatment. Additionally, the scheduled monitoring required in 12 months are applied as a daily cost during the treatment duration.

Monitoring costs at baseline and for the subsequent 12 months are presented in *Tables 83* and *84* respectively.

AbbVie report that:

*As per the guidelines it was assumed that any monitoring or lab tests in the first three months would be done by a specialist nurse and a shared care arrangement made with general practitioners (GPs) thereafter with routine clinic follow-up on a regular basis. We assumed that a health-care visit was associated with each sequence of laboratory tests. Monitoring subsequently to the first 3 months was assumed to occur at a primary care setting in 60–70% of cases as advised by experts, with the remainder of monitoring being carried out at a hospital. To calculate the distribution of visits the total number of visits beyond the first 3 months was multiplied by 65% and rounded to the closest integer to obtain the number of GP visits. For annual monitoring beyond 6 months, where the number of health-care visits was calculated to be below four, equal distribution between primary and secondary care settings was used to account for regular clinic attendances.*

Protocols were not available for GOL; thus, the same monitoring pattern as for ADA was assumed. For combination therapies the maximum requirement for each test from the respective therapies was assumed.

*Monitoring costs are set to zero for rescue therapy, apart from an outpatient visit cost every two months as advised by clinical experts. These experts further advised that patients on rescue therapy would be subject to one inpatient admission of approximately three weeks annually. This was not included as additional resource use to avoid double-counting with HAQ-based inpatient and surgery costs. Rescue therapy refers to medical treatment once all active therapies, including traditional DMARDs and biologic treatments, have failed; and is assumed to consist of MTX.*

AbbVie acknowledges that monitoring protocols from the British Society of Rheumatology would be more representative of the population modelled, rather than regional guidelines detailed in the Bradford Primary Care Trust protocols. As monitoring patterns from the British Society of Rheumatology<sup>229</sup> are not detailed for biologic therapies, the Bradford protocols were used in the base case as all relevant comparators were included, thus allowing for consistent costing of monitoring patterns without the requirement of further assumptions. AbbVie demonstrates the total costs of monitoring for DMARDs between the two sources were reasonably comparable with slightly higher estimates obtained using Bradford protocols. Alternative monitoring patterns from the British Society of Rheumatology, assuming the same monitoring pattern as that of MTX for biologic arms, were tested in scenario analysis. In addition, the sensitivity of monitoring costs was tested by increasing the total monitoring costs for each comparator by 50%.

### Bristol-Myers Squibb

Infliximab, ABT i.v. and TCZ are administered as infusions, with s.c. treatments assumed to require visits to a nurse specialist in year 1.<sup>171</sup> Treatment with GLD is assumed to require a visit to a general practitioner (GP) for each dose. Bristol-Myers Squibb assumes that cDMARDs and TCZ require tests before and during treatment. The annual monitoring costs assumed by Bristol-Myers Squibb are shown in *Table 85*.

Bristol-Myers Squibb presents a combined intervention acquisition, administration and monitoring cost. All of the bDMARDs are coprescribed with MTX, so all include the annual costs for MTX treatment. The additional year 1 costs for MTX are included only once in the model, as it is assumed that patients move straight onto the next biologic treatment and so do not cease and restart treatment with MTX. These values are replicated in *Table 86*.

### Merck Sharp & Dohme Corp.

Merck Sharp & Dohme Corp. notes that, although many of the TNF- $\alpha$  inhibitors are administered at home, patients are often initially taught how to administer treatment within a hospital. This is calculated as a one-off administration cost.

**TABLE 85** The administration costs and monitoring costs assumed by Bristol-Myers Squibb

Treatment	Administration costs (£)		Monitoring costs (£)	
	Annual cost	Year 1 additional cost	Annual cost	Year 1 additional cost
ABT i.v.	1777	136	0	0
ABT s.c.	0	283	0	0
ADA	0	147	0	0
ETN	0	147	0	0
IFX	888	136	0	0
TCZ	1777	0	557	554
GOL	0	147	0	0
CTZ	0	147	0	0
RTX	188	0	0	0
LEF	0	0	854	1263
GLD	516	860	1710	2849
CYC	0	0	1671	1127
AZA	0	0	1709	854
MTX	0	0	1709	570
Palliative care			545	0

**TABLE 86** Summarised total and annual costs assumed by Bristol-Myers Squibb

Treatment	Annual cost (£)	Start-up cost (£)
ABT i.v.	CiC information has been removed	CiC information has been removed
ABT s.c.	CiC information has been removed	CiC information has been removed
ADA	10,913.92	147.00
ETN	11,053.76	147.00
IFX	10,825.87	1395.06
TCZ	CiC information has been removed	CiC information has been removed
GOL	10,882.48	147.00
CTZ	11,053.76	-2355.50 <sup>a</sup>
RTX	6732.08	0.00
LEF	1601.34	1408.44
GLD	2360.40	4079.56
CYC	3356.35	1275.33
AZA	1806.55	999.75
Palliative care	544.80	0.00
MTX		733.48

<sup>a</sup> The year 1 additional cost for CTZ is negative due to drug costs (the free doses in the PAS). However, patients receive CTZ for a minimum of 6 months, so the cost is always positive. All costs include cost of MTX.

Merck Sharp & Dohme Corp. reports that the current clinical management of this condition requires patients to have a regular contact with the specialist rheumatology centres in the UK. This was estimated in consultation with two expert clinicians in the UK. Initial resource use estimates were made based on the assumptions made in the Birmingham Rheumatoid Arthritis Model. These were reviewed and validated or changed by the clinical experts. Recent guidelines from the ACR and the British Society for Rheumatology were also reviewed for consistency with our assumptions.

In order to determine the total treatment cost in the model, routine monitoring costs of patients are aggregated. In the UK patient monitoring includes visits to a rheumatologist after 6 months then every 12 months, GP visits every 6 months and a specialist nurse visit every 6 months.

Resource use costs for the UK were sourced from the NHS reference costs (2010–11)<sup>224</sup> and the Personal Social Services Research Unit (2011).<sup>228</sup> It is common in the UK for patients to regularly visit a specialist rheumatology nurse more frequently than their rheumatologist. *Table 87* presents the unit costs assumed by MSD.

For i.v. drugs (INF, TCZ and ABT i.v.) administration costs are higher and incurred at every administration of treatment. In the UK the cost of infusion is £50 with an additional £59 administration cost. The cost of infusion is assumed equivalent to a visit to a specialist nurse plus an hourly charge for the care of the patient while they are on the ward. MSD assumed that infusion costs can be charged only per whole hour.

In order to account for the difference in cost between initiation of treatment and maintenance treatment, the cost of the first cycle of treatment is aggregated separately to the cost of subsequent cycles of treatment. *Table 88* reports the cost of administration treatment included in the model. As this was combined with intervention acquisition costs, these have been included for completeness.

**TABLE 87** The unit costs of monitoring assumed by MSD

Health-care resource	Unit cost (£)	Source
Rheumatologist	132.07	NHS reference costs 2010–11 (Consultant Led: Follow up Attendance Non-Admitted Face to Face 410) <sup>224</sup>
GP	53.00	Curtis, 2011, p. 149 <sup>228</sup>
Specialist nurse	50.00	Curtis, 2011, p. 144 <sup>228</sup>
Nurse practitioner	42.00	Curtis, 2011, p. 146 <sup>228</sup>
FBC	3.36	NHS reference costs 2010–11 (NHS Trusts Direct Access: Pathology Services DAP823) <sup>224</sup>
ESR	1.26	NHS reference costs 2010–11 (NHS Trusts Direct Access: Pathology Services DAP841) <sup>224</sup>
Biochemistry profile	3.36	NHS reference costs 2010–11 (NHS Trusts Direct Access: Pathology Services DAP823) <sup>224</sup>
CRP	3.36	NHS reference costs 2010–11 (NHS Trusts Direct Access: Pathology Services DAP823) <sup>224</sup>
TB test	1.26	NHS reference costs 2010–11 (NHS Trusts Direct Access: Pathology Services DAP841) <sup>224</sup>
Hepatitis B and hepatitis C	3.36	NHS reference costs 2010–11 (NHS Trusts Direct Access: Pathology Services DAP823) <sup>224</sup>
Urinalysis	1.26	NHS reference costs 2010–11 (NHS Trusts Direct Access: Pathology Services DAP841) <sup>224</sup>
Chest X-ray	29.04	NHS reference costs 2010–11 (NHS Trusts Outpatient DAPF) <sup>224</sup>

FBC, full blood count; TB, tuberculosis.

**TABLE 88** The assumed administration, monitoring and drug acquisition costs assumed by MSD

Intervention	Cost per dose (£)	Number of doses per first 6 months	Number of doses post 6 months	Treatment cost first 6 months (£)	Treatment cost post 6 months (£)	Cost per administration first 6 months (£)	Total cost first 6 months (£)	Total cost post 6 months (£)
GOL	762.97	6	6	4577.82	4577.82	59.00	4636.82	4577.82
ADA	352.14	13	13	4577.82	4577.82	59.00	4636.82	4577.82
IFX <sup>a</sup>	1133.20	5	3.25	5666.00	3682.90	109.00	6211.00	4037.15
ETN	89.38	52	52	4647.76	4647.76	59.00	4706.76	4647.76
TCZ <sup>b</sup>	698.32	7	6.5	4888.24	4539.08	109.00	5651.24	5247.58
CTZ <sup>c</sup>	357.50	6	13	2145.00	4647.50	59.00	2204.00	4647.50
LEF	1.88	205	178	385.40	334.64	0.00	385.40	334.64
GLD	13.48	26	26	350.48	350.48	0.00	350.48	350.48
AZA	0.07	547.5	547.5	38.33	38.33	0.00	38.33	38.33
CYC	2.14	365	365	781.10	781.10	0.00	781.10	781.10
MTX	0.05	78	78	3.90	3.90	0.00	3.90	3.90
ABT i.v. <sup>d</sup>	864.92	8	6.5	6919.35	5621.97	109.00	7791.35	6330.47
ABT s.c. <sup>e</sup>	302.40	26	26	8727.32	7862.40	59.00	8895.32	7862.40
RTX	1746.30	2	1.3	3492.60	2270.19	109.00	3710.60	2411.89

a Average of 2.70 vials with wastage.

b Average cost per infusion: £887.32 with wastage.

c Includes PAS.

d Includes PAS and average of 2.86 vials with wastage.

e Includes i.v. loading dose and associated administration cost.



## Pfizer

Pfizer reported that the costs associated with pre-treatment monitoring were in accordance with the previous evidence review group models and recent manufacturer's submission to NICE. These were reported to be then validated at an advisory board. In addition to the costs of tests, an outpatient rheumatology contact (service code 410) was assumed, at a cost of £137.<sup>230</sup> *Table 89* provides the unit costs of pre-treatment test while *Table 90* summarises the estimated total cost per intervention. Monitoring costs were assumed to be included in the general costs per HAQ band and were thus not included.

**TABLE 89** Unit costs of pre-treatment tests assumed by Pfizer

AiC information has been removed	AiC information has been removed	AiC information has been removed	AiC information has been removed
AiC information has been removed	AiC information has been removed	AiC information has been removed	AiC information has been removed
AiC information has been removed	AiC information has been removed	AiC information has been removed	AiC information has been removed
AiC information has been removed	AiC information has been removed	AiC information has been removed	AiC information has been removed
AiC information has been removed	AiC information has been removed	AiC information has been removed	AiC information has been removed
AiC information has been removed	AiC information has been removed	AiC information has been removed	AiC information has been removed
AiC information has been removed	AiC information has been removed	AiC information has been removed	AiC information has been removed
AiC information has been removed	AiC information has been removed	AiC information has been removed	AiC information has been removed
AiC information has been removed	AiC information has been removed	AiC information has been removed	AiC information has been removed
AiC information has been removed	AiC information has been removed	AiC information has been removed	AiC information has been removed

**TABLE 90** Pre-treatment costs per intervention assumed by Pfizer

AiC information has been removed	AiC information has been removed	AiC information has been removed
AiC information has been removed	AiC information has been removed	AiC information has been removed
AiC information has been removed	AiC information has been removed	AiC information has been removed
AiC information has been removed	AiC information has been removed	AiC information has been removed
AiC information has been removed	AiC information has been removed	AiC information has been removed
AiC information has been removed	AiC information has been removed	AiC information has been removed
AiC information has been removed	AiC information has been removed	AiC information has been removed
AiC information has been removed	AiC information has been removed	AiC information has been removed

The costs of infusion were uplifted by Pfizer from costs presented by Roche in TA198<sup>231</sup> to 2011/12 prices using Curtis.<sup>232</sup>

The summary of acquisition costs, monitoring and administration costs provided by MSD is replicated in *Table 91*.

### Roche

*Table 92* presents administration costs for all the treatments. The model assumes a district nurse will administer 10% of the s.c. injection treatments.

The economic model assumes the same schedule of monitoring for all biologics as in the previous NICE submission for TCZ.<sup>231</sup> The cost of TCZ monitoring is assumed to be included in the administration cost: £171.33 per i.v. infusion<sup>180</sup> updated to 2009/10 prices.<sup>233</sup>

The monitoring cost of ADA, CTZ and ETN is assumed to follow the schedule presented in *Table 93*. Palliative care is assumed to have only monitoring costs, but a greater number of outpatient follow-up visits in the first cycle and greater resource use in subsequent cycles, resulting in costs of £2589 and subsequent costs of £1287.

Roche provide a summary table of acquisition, monitoring and administration costs. This is replicated in *Table 94*.

### UCB Pharma

The monitoring schedule assumed by UCB Pharma is replicated in *Table 95*. UCB Pharma presents unit costs, but for brevity only the summarised monitoring data, together with drug acquisition costs, are provided in *Tables 95* and *96*, respectively.

### Comparative treatment efficacy (network meta-analysis)

This section contains the analyses regarding comparative efficacies undertaken by each manufacturer. For consistency, the term NMA has been used even when a manufacturer has denoted the analysis to be a mixed-treatment comparison.

The level of detail in the analyses and in the reporting was very diverse, ranging from the submission by AbbVie, which included a 378-page appendix, to the submission by Roche that consisted of one-page concerning the NMA. The Assessment Group has attempted to capture all key points made by the manufacturer but has had, for brevity reasons, to abridge some analyses. Detailed discussions on the methods used, goodness of fits, consistency checking and convergence have not been incorporated. Similarly, replications of the list of studies that have been used in the NMA by the manufacturers have not been undertaken.

### AbbVie

The trials included in AbbVie's base-case NMA are depicted in *Figure 37*, which has been reproduced directly from the AbbVie submission. The numbers on the line have been included by AbbVie without a reference, but are believed to represent codes for RCTs; thus, six numbers would indicate six trials informing the direct comparison. Furthermore, AbbVie used different abbreviations from those used in by the Assessment Group. It is commented that there is no cDMARD node, which is assumed to be subsumed within the PBO arm.

TABLE 91 The assumed acquisition and administration costs assumed by Pfizer

Treatment	Dosing assumptions	Unit cost (£) <sup>a</sup>	Unit dose (mg)	Administration costs (£)		Assume vial wastage?
				First administration	Subsequent administration	
ABT i.v.	Body weight ≤ 60 kg, 500 mg; 61–100 kg, 750 mg; > 100 kg, 100 mg; repeated 2 weeks and 4 weeks after initial infusion, then every 4 weeks	302.40	250	151.95 <sup>b</sup>	151.95 <sup>b</sup>	Yes
ADA	40 mg every other week	352.14	40	49.00 <sup>c</sup>	0.00	N/A
CTZ	400 mg at 0, 2 and 4 weeks then 200 mg every 2 weeks (PAS 10 for free)	357.50	200	49.00 <sup>c</sup>	0.00	N/A
CYC	Maximum of 4 mg/kg daily in two divided doses	51.50	3000	0.00	0.00	N/A
ETN	25 mg BIW	89.38	25	49.00 <sup>c</sup>	0.00	N/A
ABT s.c.	Loading dose by i.v. initially, then first 125 mg s.c. injection given within a day, followed by 125 mg s.c. OW	302.40 <sup>d</sup>	125	49.00 (of s.c. first administration) <sup>e</sup>	0.00	N/A
GOL	50 mg every 4 weeks	762.97	50	49.00 <sup>c</sup>	0.00	N/A
IFX	3 mg/kg at weeks 0, 2 and 6, thereafter every 8 weeks	419.62	100	151.95 <sup>b</sup>	£151.95 <sup>b</sup>	Yes
LEF	Assumed 20 mg OD	61.36	600	0.00	0.00	N/A
MTX	15 mg OW	48.44	1000	0.00	0.00	N/A
PC	Assumed to be additive combination of MTX, LEF, CIC (oral)	N/A	N/A	0.00	0.00	N/A
RTX	1000 mg repeated 2 weeks after initial infusion = one course; each course 9 months apart	873.15	500	441.00 <sup>f</sup>	441.00 <sup>f</sup>	N/A <sup>g</sup>
SSZ	2000 mg/day	14.83	56,000	0.00	0.00	N/A
TCZ	8 mg/kg every 4 weeks	102.40	80	151.95 <sup>b</sup>	151.95 <sup>b</sup>	Yes
Combination therapy with cDMARD	Assumed to be additive combination of MTX and SUL	N/A	N/A	0.00	0.00	N/A

BIW, twice weekly; CIC, ciclosporin; N/A, not applicable; OD, once daily; OW, once weekly; PC, palliative care; SUL, sulfasalazine.

a BNF 64.<sup>221</sup>

b Uplifted from costs presented by Roche in TA198<sup>231</sup> to 2011/12 prices using Curtis, 2012.<sup>232</sup>

c One-hour community nurse time from Curtis, 2012.<sup>232</sup>

d *British National Formulary*, 2013.<sup>222</sup>

e Model includes cost of i.v. loading dose: assumed to be the same as first administration of ABT and applied at the start of the strategy.

f 2 × day case cost for HD23C Inflammatory Spine, Joint or Connective Tissue Disorders, without CC.<sup>230</sup>

g Because the dose for RTX is 1000 mg and unit size is 500 mg, there was no vial wastage.

**TABLE 92** The administration costs assumed by Roche

Treatment	Total cost of administration first 6 months and subsequent cycles (responders) (£)	Assumptions	Source (cost)
ADA	35.10	10% of injections are given by district nurse; cost of district nurse £27.00	Curtis <i>et al.</i> , 2010 <sup>233</sup>
CTZ	35.10	10% of injections are given by district nurse; cost of district nurse £27.00	Curtis <i>et al.</i> , 2010 <sup>233</sup>
ETA	70.20	10% of injections are given by district nurse; cost of district nurse £27.00	Curtis <i>et al.</i> , 2010 <sup>233</sup>
TCZ	1113.63	Cost of £171.33 for each infusion given in a cycle (inflated 2000 to 2010)	Barton <i>et al.</i> , 2004 <sup>180</sup>

**TABLE 93** The monitoring costs assumed by Roche for ADA, CTZ and ETN

Resource or test	Unit cost (£)	Monitoring frequency per 6 months (first cycle)	Total cost (first cycle: responder) (£)	Frequency of monitoring per 6 months (subsequent cycles)	Total cost (subsequent cycles) (£)	Source
Outpatient visit first attendance	214.00	1	214.00	0	0.00	Department of Health, 2011 <sup>234</sup>
Outpatient visit follow-up visit	126.00	6	756.00	3	378.00	Department of Health, 2011 <sup>234</sup>
GP visit	53.00	4	212.00	3	159.00	Department of Health, 2011 <sup>234</sup>
FBC	3.00	14	42.00	3	9.00	Department of Health, 2011 <sup>234</sup>
ESR and CRP	15.41	14	215.68	3	46.22	Barton <i>et al.</i> , 2004 <sup>180</sup>
Liver function test	8.55	14	119.74	3	25.66	Barton <i>et al.</i> , 2004 <sup>180</sup>
Urea, electrolytes and creatinine	8.55	14	119.74	3	25.66	Barton <i>et al.</i> , 2004 <sup>180</sup>
Chest radiography	27.63	1	27.63	0	0.00	Barton <i>et al.</i> , 2004 <sup>180</sup>
Total			1706.79		643.53	

FBC, full blood count.



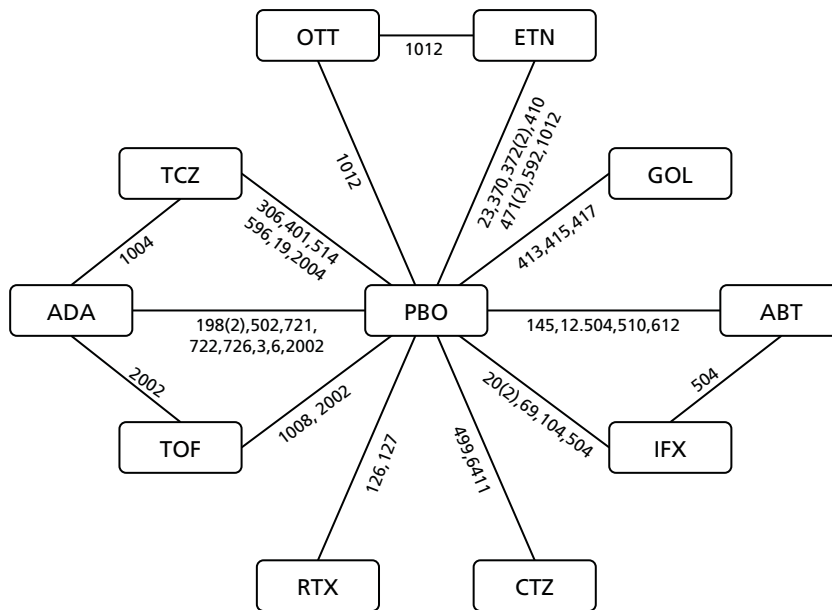
**TABLE 95** Drug monitoring schedule: visits during first 6 months and every 6 months thereafter assumed by UCB Pharma (*continued*)

	AiC information has been removed		AiC information has been removed	
	AiC information has been removed	AiC information has been removed	AiC information has been removed	AiC information has been removed
AiC information has been removed	AiC information has been removed	AiC information has been removed	AiC information has been removed	AiC information has been removed
AiC information has been removed	AiC information has been removed	AiC information has been removed	AiC information has been removed	AiC information has been removed
AiC information has been removed	AiC information has been removed	AiC information has been removed	AiC information has been removed	AiC information has been removed
AiC information has been removed	AiC information has been removed	AiC information has been removed	AiC information has been removed	AiC information has been removed
AiC information has been removed	AiC information has been removed	AiC information has been removed	AiC information has been removed	AiC information has been removed
AiC information has been removed	AiC information has been removed	AiC information has been removed	AiC information has been removed	AiC information has been removed
AiC information has been removed	AiC information has been removed	AiC information has been removed	AiC information has been removed	AiC information has been removed
AiC information has been removed	AiC information has been removed	AiC information has been removed	AiC information has been removed	AiC information has been removed
AiC information has been removed	AiC information has been removed	AiC information has been removed	AiC information has been removed	AiC information has been removed
AiC information has been removed	AiC information has been removed	AiC information has been removed	AiC information has been removed	AiC information has been removed
AiC information has been removed	AiC information has been removed	AiC information has been removed	AiC information has been removed	AiC information has been removed
AiC information has been removed	AiC information has been removed	AiC information has been removed	AiC information has been removed	AiC information has been removed
AiC information has been removed	AiC information has been removed	AiC information has been removed	AiC information has been removed	AiC information has been removed
AiC information has been removed	AiC information has been removed	AiC information has been removed	AiC information has been removed	AiC information has been removed









**FIGURE 37** The evidence network in AbbVie's base case. OTT, oral triple therapy.

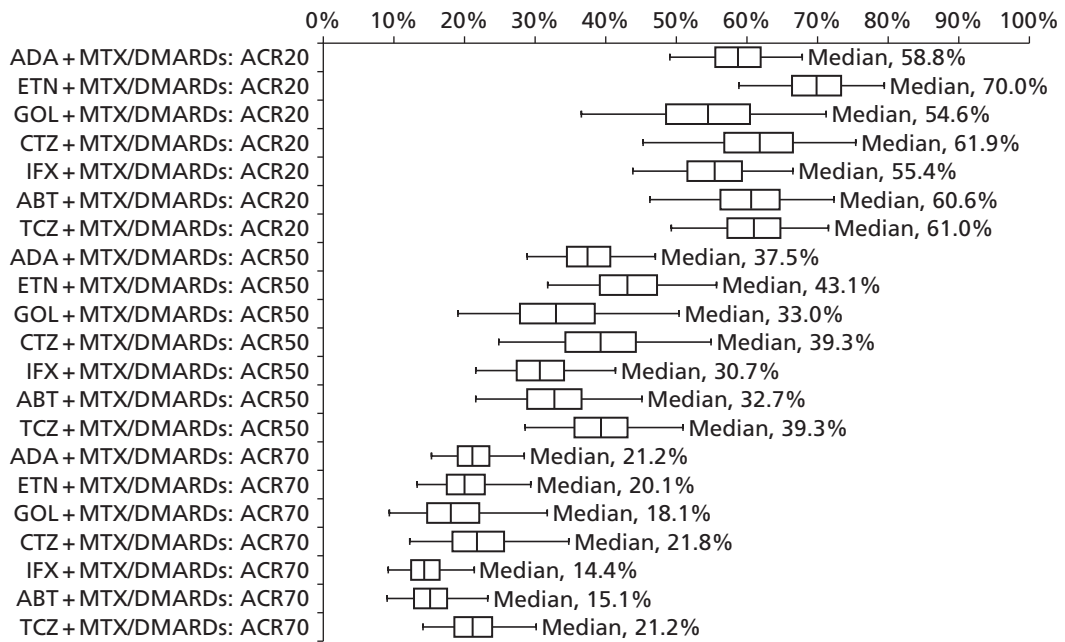
AbbVie incorporated hurdles within the analyses to eliminate illogical results such as the possibility that a patient may be simulated an ACR50 response, but not an ACR20 response. This was achieved by using parameters such as, of those who have gained an ACR20 response, what proportion achieved an ACR50 response. Within the base case, AbbVie adjusted for baseline risk, prior MTX exposure, prior bDMARD exposure and concomitant standard DMARD. AbbVie report that additional sensitivity analysis controlling for differences in baseline HAQ-DI and disease duration slightly worsened model fit assessed by the deviance information criterion and had little effect on overall results.

AbbVie presents posterior simulated ACR responses for four main groups:

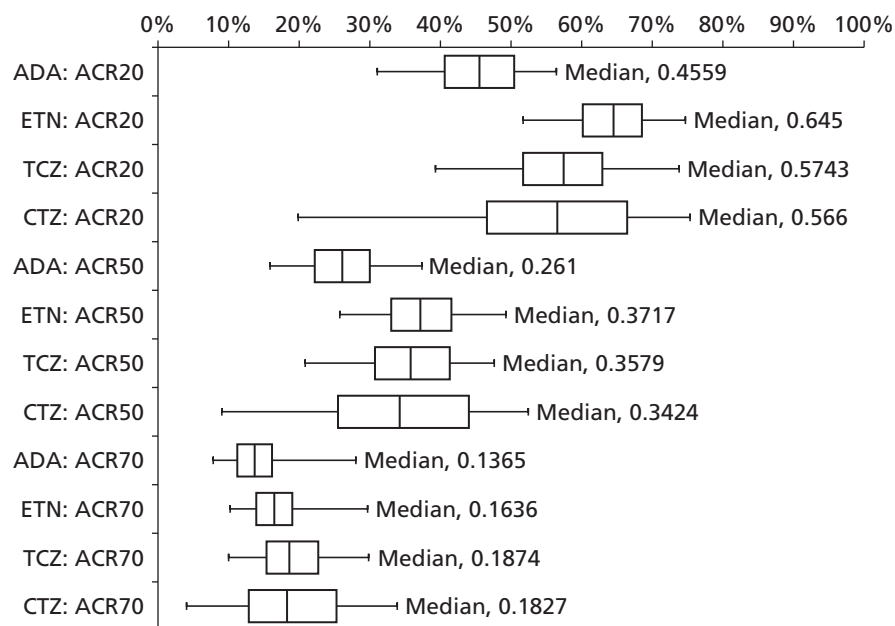
1. MTX-experienced patients who can receive cDMARDs (*Figure 38*)
2. MTX-experienced patients who receive bDMARD monotherapy (*Figure 39*)
3. MTX-naive patients who can receive cDMARDs (*Figure 40*)
4. MTX-naive patients who receive bDMARD monotherapy (*Figure 41*).

Further analyses (not shown in the Assessment Group summary) investigated a number of sensitivity analyses. These included:

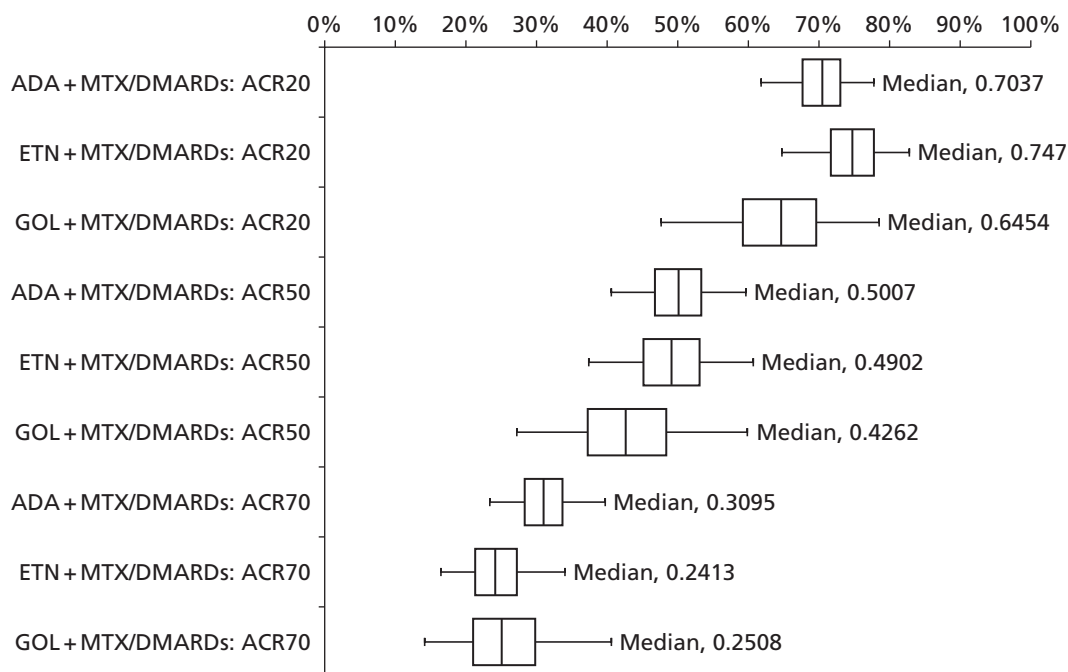
- The efficacy of TCZ and RTX compared with MTX when used after a bDMARD. These results indicated that the efficacy of TCZ was lower following an initial bDMARD than in people who were bDMARD naive.
- The inclusion of Asian studies which were shown to favour TCZ monotherapy and slightly favour CTZ.
- Limiting the data to a 3-month data set. AbbVie comments that, as one would expect, there are lower estimated median response probabilities at higher levels of response, particularly for ACR70, for most treatments including ADA, CTZ, ETN, GOL and TCZ, compared with the '6-month' estimates. The only exceptions are ABT and INF in the MTX-experienced, combination therapy scenario.



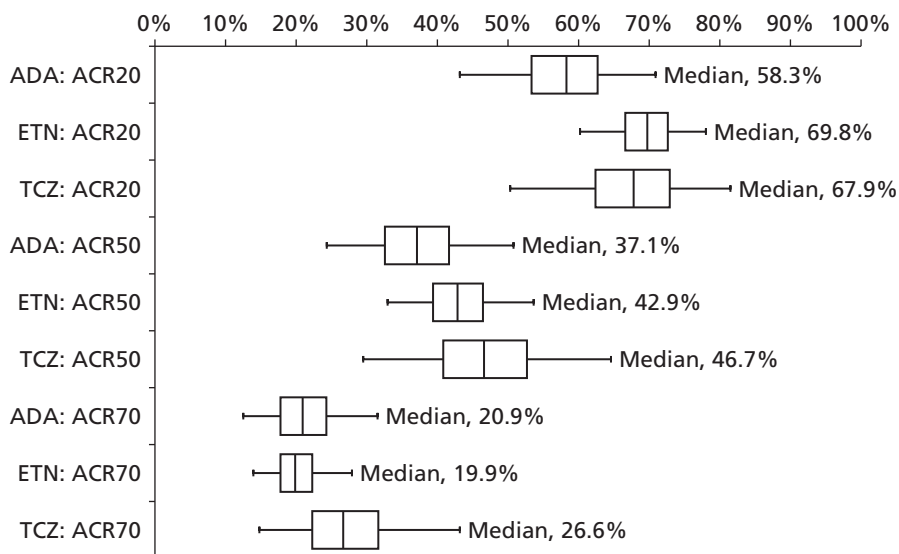
**FIGURE 38** Posterior simulated ACR response for combination therapy in a MTX-experienced population presented by AbbVie.



**FIGURE 39** Posterior simulated ACR response for monotherapy in a MTX-experienced population presented by AbbVie.



**FIGURE 40** Posterior simulated ACR response for combination therapy in a MTX-naive population presented by AbbVie.



**FIGURE 41** Posterior simulated ACR response for monotherapy in a MTX-naive population presented by AbbVie.

### AbbVie's interpretation of the network meta-analysis data

AbbVie states that:

... for the MTX-experienced patient population, biologics in combination with MTX or other DMARDs, median posterior simulated ACR20 responses for the 6 month estimates are highest for etanercept and lowest for golimumab. The interquartile ranges are tighter for the three older anti-TNFs, adalimumab, etanercept and infliximab, as well as abatacept than for golimumab and certolizumab. Median posterior simulated ACR50 responses are highest for etanercept and lowest for infliximab, while ACR70 responses are highest for adalimumab and certolizumab and lowest for abatacept and infliximab. Estimated responses get tighter the higher the level of ACR response.

### Bristol-Myers Squibb

The inclusion and exclusion criteria for selecting the RCTs to be evaluated in the NMA were not well reported; nor were the time points at which data were extracted, the methods used within the NMA, the assumed properties of the frequentist and Bayesian analyses. Bristol-Myers Squibb provides NMAs of HAQ scores and of DASs. Bristol-Myers Squibb did not report whether or not the frequentist or Bayesian values were used within the analyses. The network for the HAQ scores is shown in Figure 42.

The mean change in HAQ is shown in Figure 43 and absolute mean change is shown in Figure 44.

The probability of being the most efficacious treatment is detailed in Figure 45, although the Assessment Group notes that, strictly, it is impossible to quantify the probability of being most efficacious using a frequentist approach.

The analysis of DAS by Bristol-Myers Squibb used a linear regression to estimate DASs from HAQ scores where these data were not provided. The assumed relationship is shown in Figure 46. No comment was made on the relationship between change in DAS and change in HAQ scores.

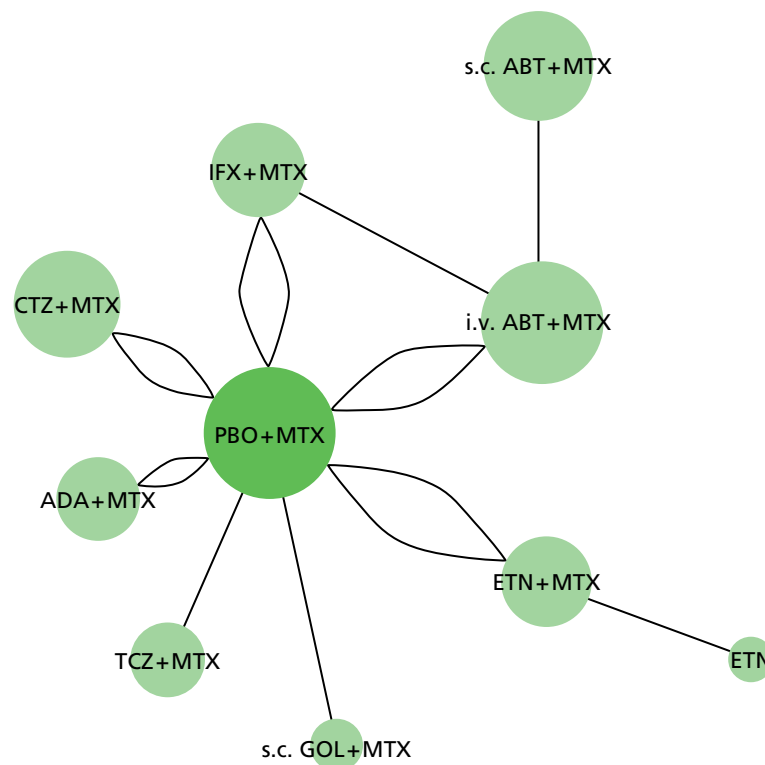


FIGURE 42 The network of evidence for HAQ scores as supplied by Bristol-Myers Squibb.

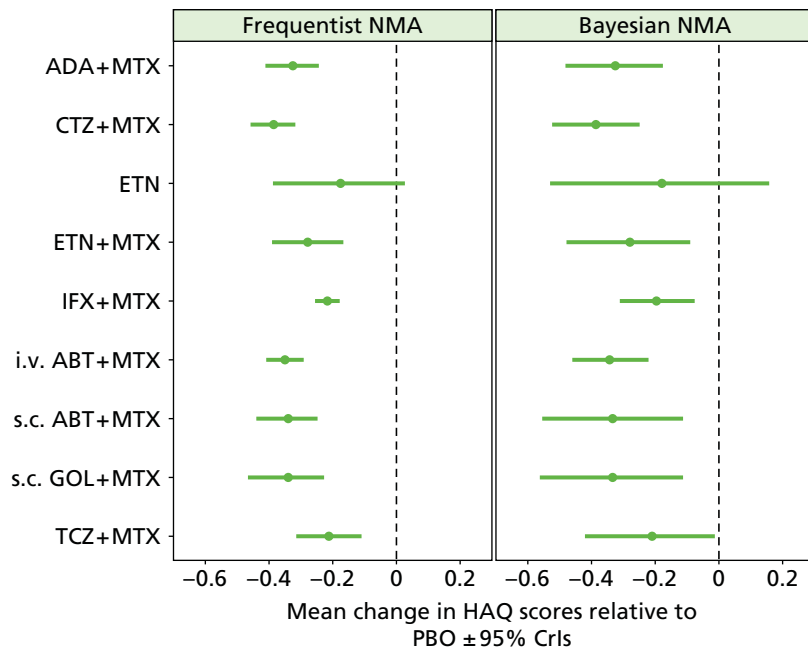


FIGURE 43 The mean change in HAQ scores relative to PBO as estimated by Bristol-Myers Squibb.

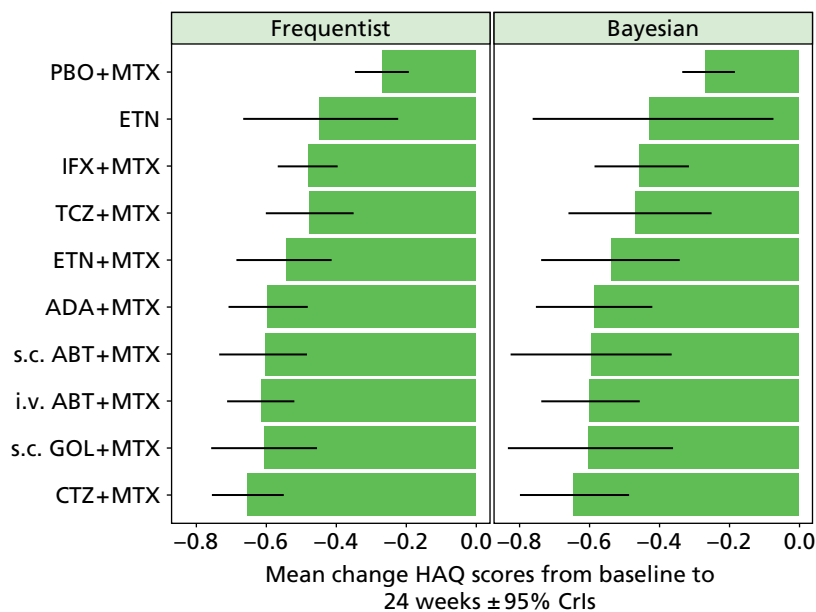
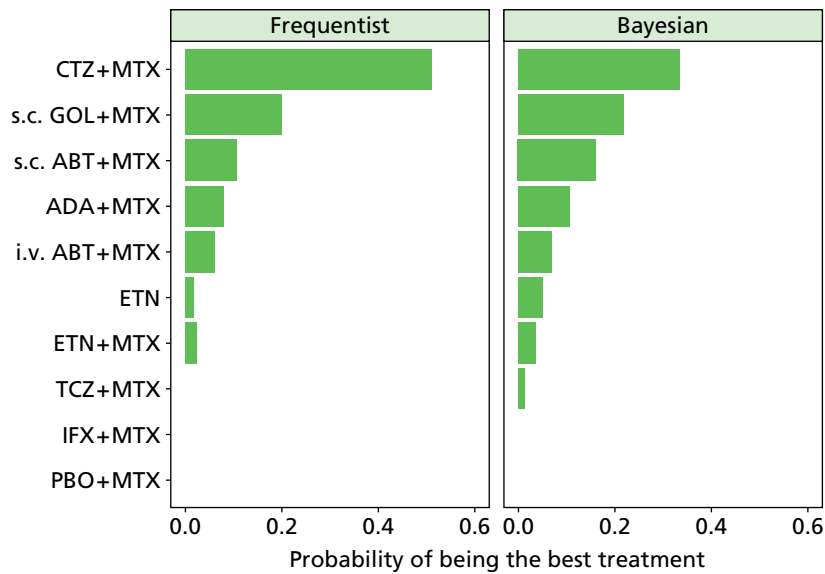
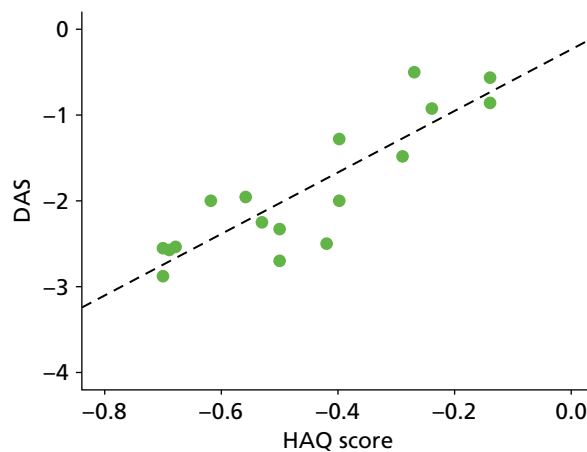


FIGURE 44 The mean absolute change in HAQ scores as estimated by Bristol-Myers Squibb.



**FIGURE 45** The probability of being the most efficacious treatment (on HAQ score) as estimated by Bristol-Myers Squibb.



**FIGURE 46** The relationship assumed by Bristol-Myers Squibb between HAQ scores and DASs.

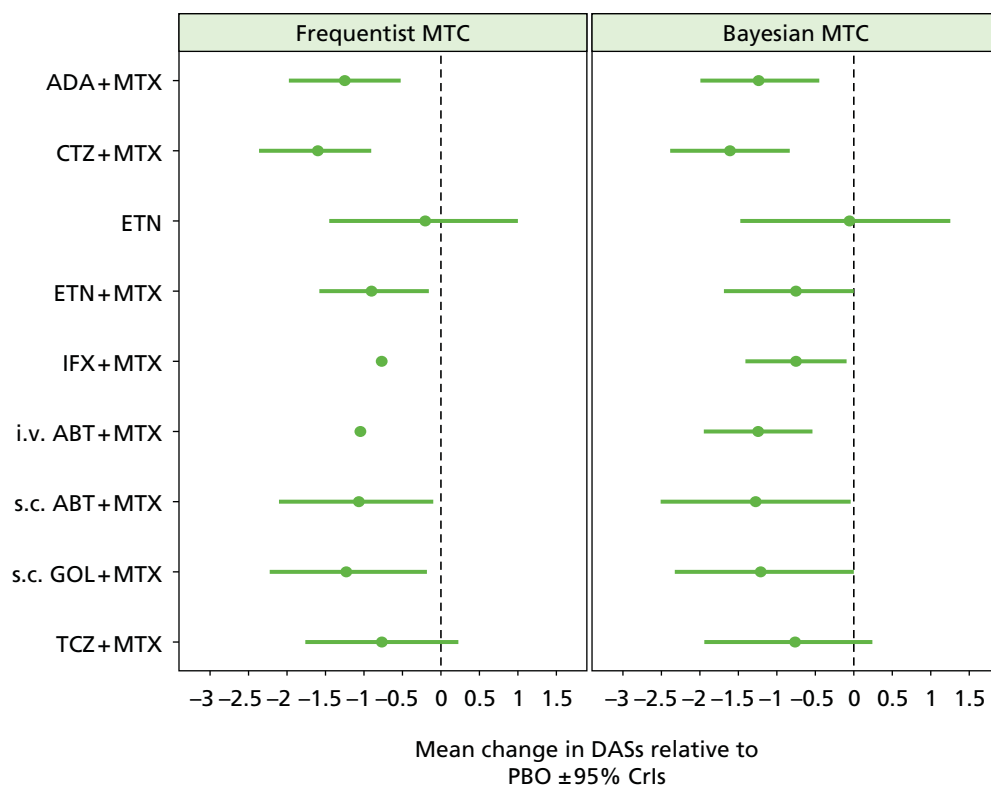
The network assumed in the DAS analyses therefore replicates that for the HAQ analyses (see *Figure 43*). As with the HAQ analyses, mean changes in DASs, absolute mean changes in DAS and the probability of being the most efficacious treatment are provided. These are shown in *Figures 47* and *48*.

The probability of being the most efficacious treatment is detailed in *Figure 49*, although the Assessment Group notes that, strictly, it is impossible to quantify the probability of being most efficacious using a frequentist approach.

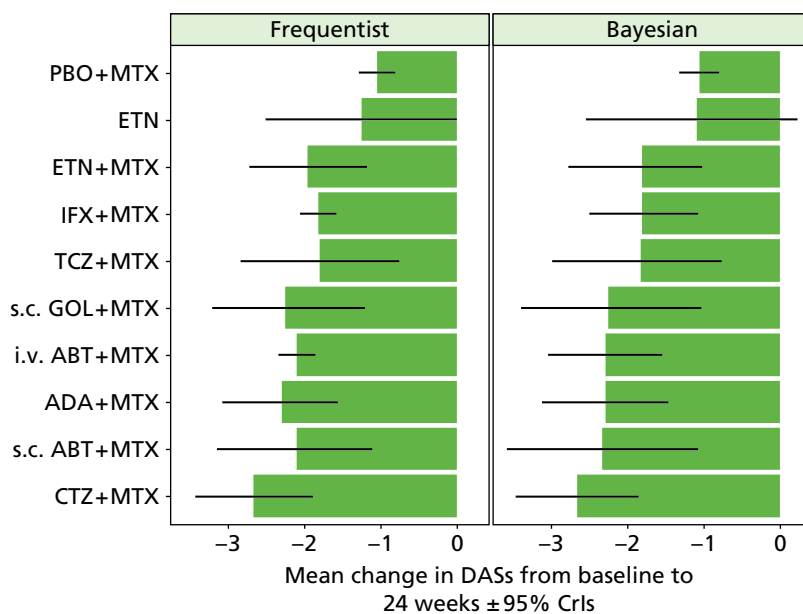
### ***Bristol-Myers Squibb's interpretation of the network meta-analysis data***

Bristol-Myers Squibb states that:

*... certolizumab + MTX seems to be the best treatment at reducing both HAQ and DAS scores ... golimumab + MTX also appears to be an effective treatment in improving QoL, along with etanercept + MTX and s.c. abatacept + MTX*



**FIGURE 47** The mean change in DAS relative to PBO as estimated by Bristol-Myers Squibb.



**FIGURE 48** The mean absolute change in DAS as estimated by Bristol-Myers Squibb.

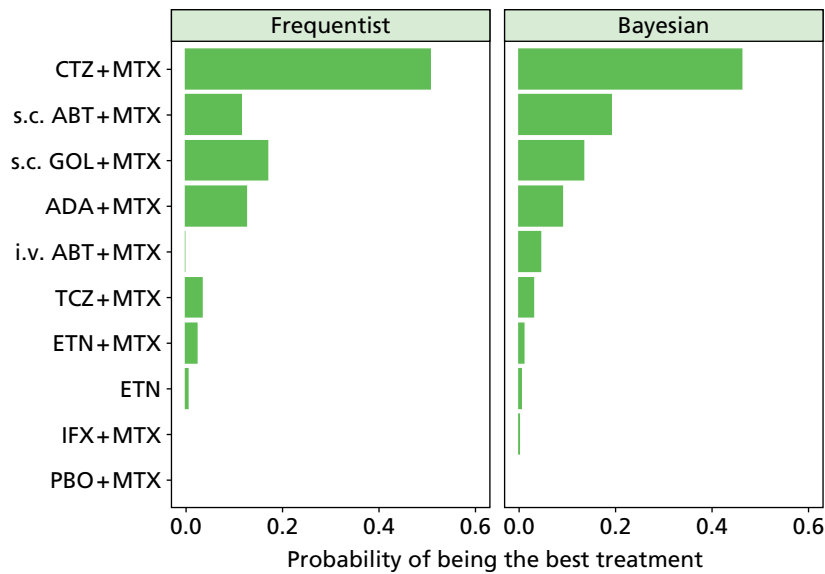


FIGURE 49 The probability of being the most efficacious treatment (on DAS) as estimated by Bristol-Myers Squibb.

and

*Infliximab + MTX and etanercept alone are expected to yield the smallest negative changes in both HAQ and DAS scores other than placebo + MTX.*

**Merck Sharp & Dohme Corp.**

The data used in the NMA conducted by MSD are contained in *Tables 16–18* of both the IFX and the GOL submission with the network reproduced in *Figure 50*. No steps were taken to ensure legitimacy (e.g. that the ACR50 value was lower than the ACR20 example).

Merck Sharp & Dohme Corp. presents results in terms of the drug that is the focus of the submission (i.e. GOL or IFX). The ACR results for GOL are shown in *Figures 51–53*, while those for IFX are shown in *Figures 54–56*.

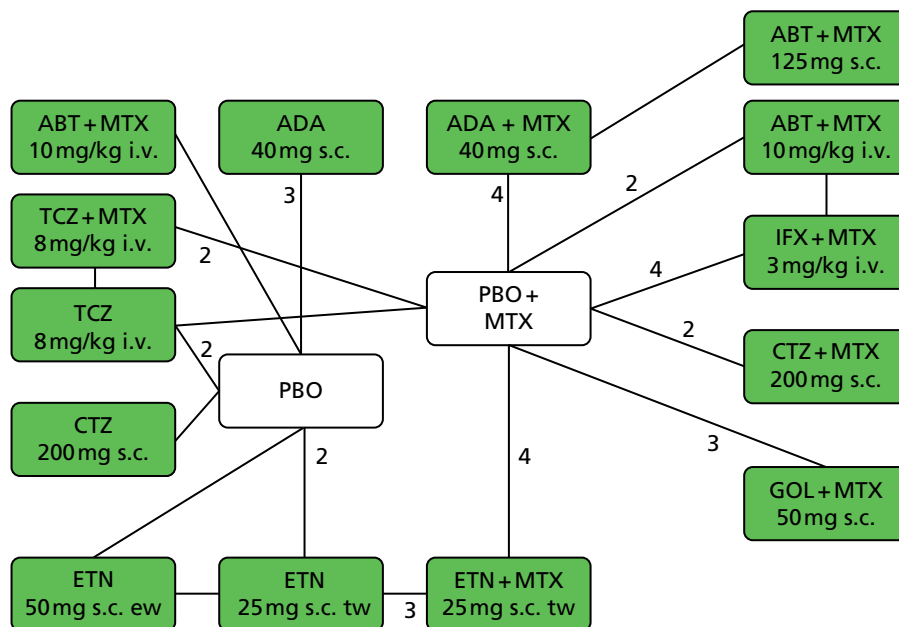
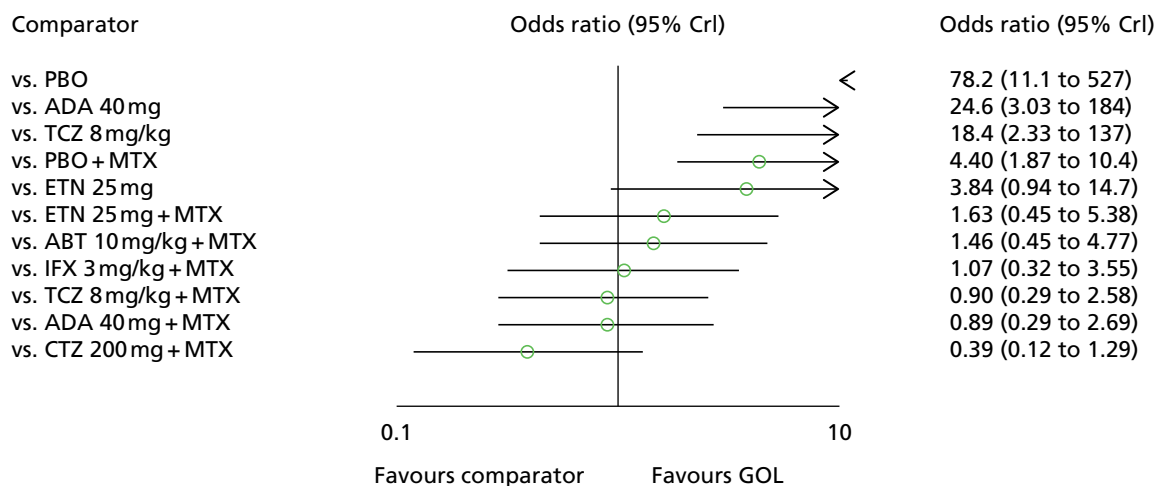
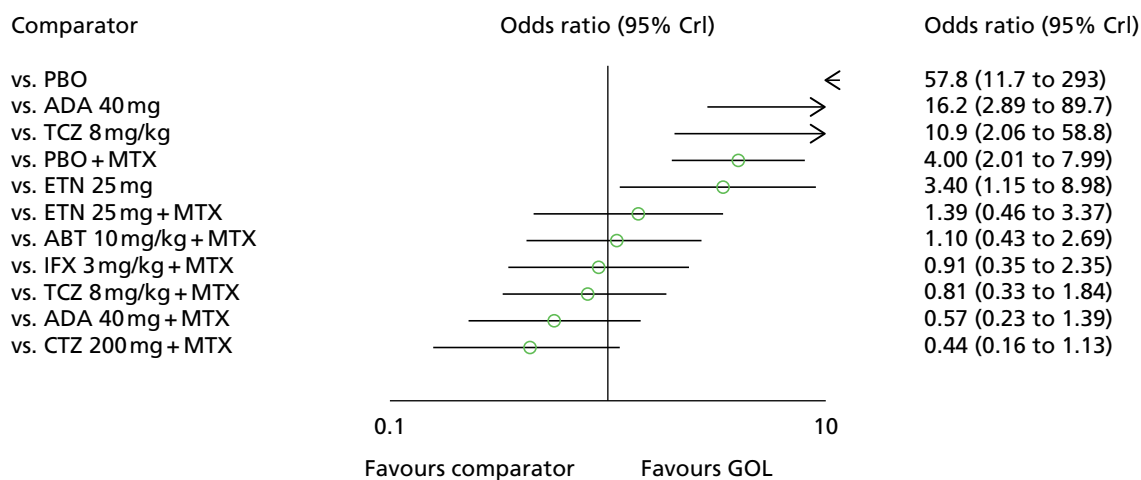


FIGURE 50 The network for DMARD-experienced patients as supplied by MSD.

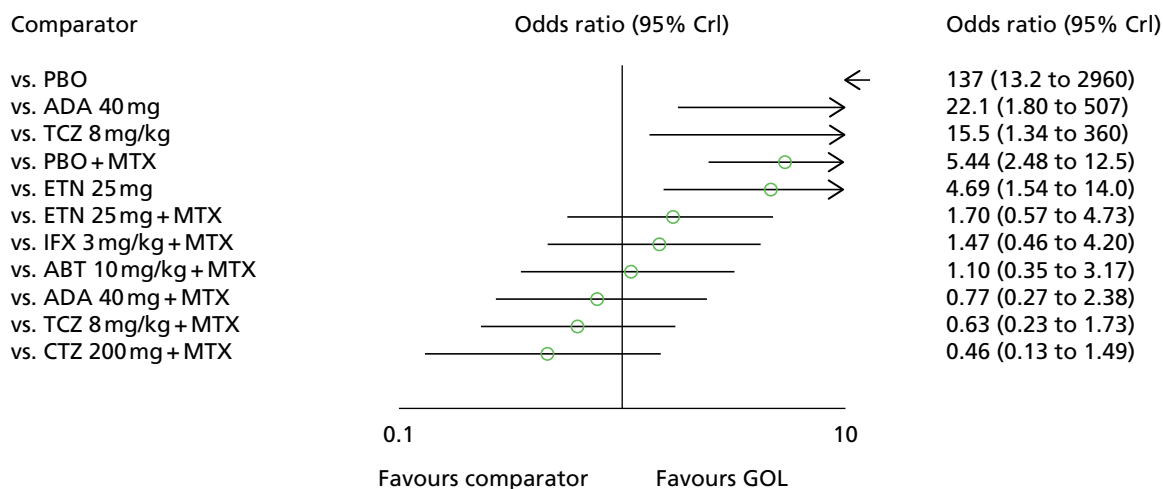




**FIGURE 51** American College of Rheumatology 20: DMARD-experienced patients at 24 weeks estimated by MSD in the GOL submission.



**FIGURE 52** American College of Rheumatology 50: DMARD-experienced patients at 24 weeks estimated by MSD in the GOL submission.



**FIGURE 53** American College of Rheumatology 70: DMARD-experienced patients at 24 weeks estimated by MSD in the GOL submission.

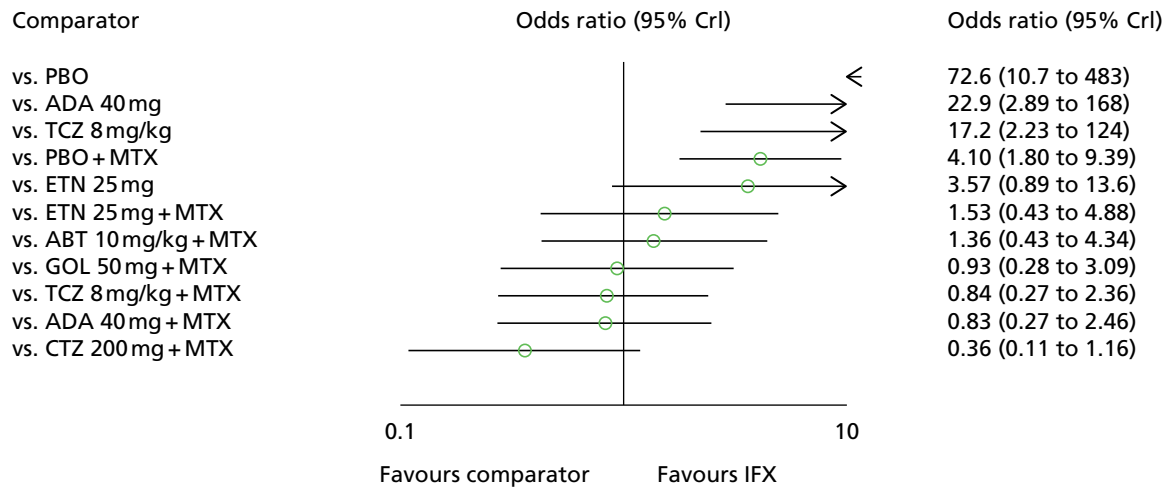


FIGURE 54 American College of Rheumatology 20: DMARD-experienced patients at 24 weeks estimated by MSD in the IFX submission.

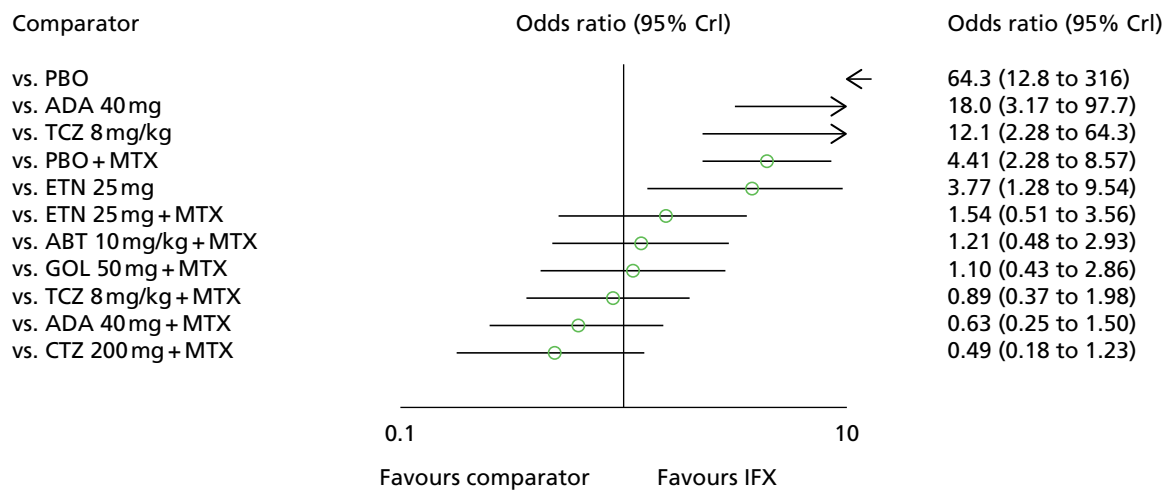


FIGURE 55 American College of Rheumatology 50: DMARD-experienced patients at 24 weeks estimated by MSD in the IFX submission.

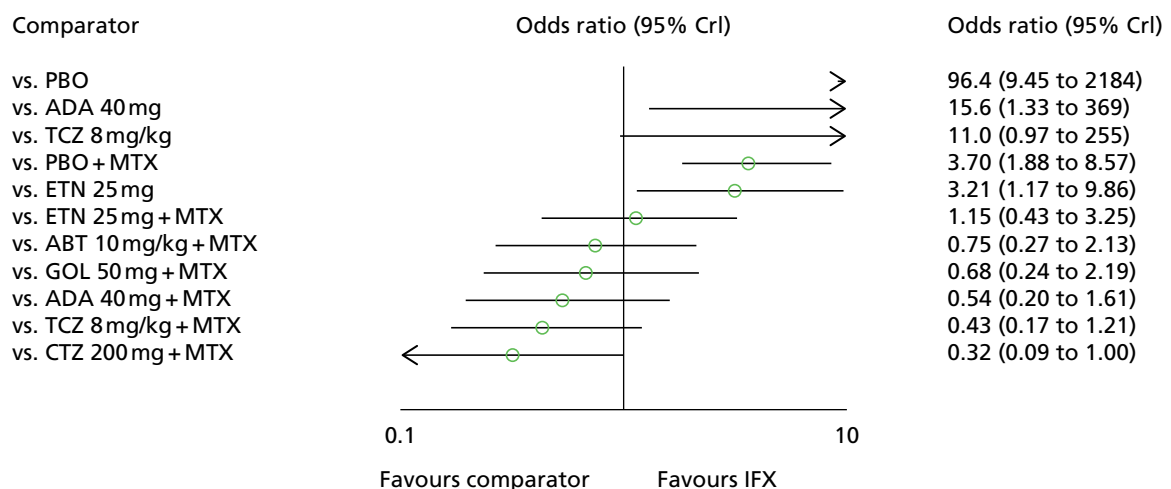


FIGURE 56 American College of Rheumatology 70: DMARD-experienced patients at 24 weeks estimated by MSD in the IFX submission.

Merck Sharp & Dohme Corp. conducted sensitivity analyses excluding open-label studies as these may have a higher potential for bias. This did not materially affect the ACR20 or ACR50 results, but had a larger (although non-patterned) impact at ACR70.

A second sensitivity analysis was conducted where Asian studies were included (*Figure 57* reproduces a figure supplied by MSD and indicates lower background MTX use in these studies): golimumab in combination with methotrexate in Japanese patients with active rheumatoid arthritis (GO-FORTH),<sup>91</sup> Study of Active controlled Monotherapy Used for Rheumatoid Arthritis, an IL-6 Inhibitor (SAMURAI),<sup>115</sup> Abe *et al.*<sup>56</sup> and Kim *et al.*<sup>99</sup>

The exclusion of non-Asian studies did not markedly alter the odds ratios which remain with wide Crls.

### Merck Sharp & Dohme Corp.'s interpretation of the results

Merck Sharp & Dohme Corp. summarises the results of the NMA for GOL and IFX as follows:

- ACR20: no significant differences were observed between GOL/IFX and other bDMARDs, with the exception of ADA monotherapy and TCZ monotherapy.
- ACR50: no significant differences were observed between GOL/IFX and other bDMARDs, with the exception of ADA monotherapy, TCZ monotherapy and ETN monotherapy.
- ACR70: no significant differences were observed between GOL/IFX and other bDMARDs, with the exception of ADA monotherapy, TCZ monotherapy and ETN monotherapy.

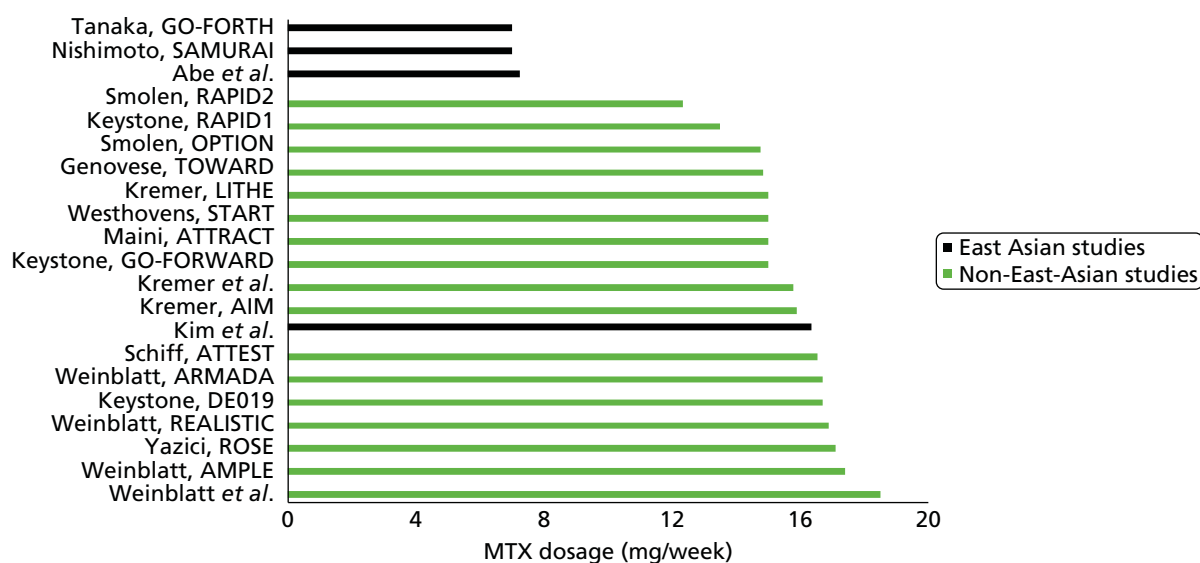
In each of the exceptions listed above, GOL and IFX were assumed to be statistically significantly better than the named intervention.

### Pfizer

Pfizer undertook three separate NMAs: ACR20/50/70 responses for a severe cDMARD-experienced population; HAQ changes for a severe cDMARD-experienced population; and ACR20/50/70 responses for a severe cDMARD-experienced population who were treated with bDMARD monotherapy. The networks for these NMAs are reproduced in *Figures 58–60*.

The results produced by each of these analyses in the base case are provided in *Tables 97–99*.

No steps were taken to ensure legitimacy (e.g. that the ACR50 value was lower than the ACR20 example).



**FIGURE 57** Comparison of MTX usage (average mg/week) in East Asian vs. non-East Asian studies supplied by MSD. Reference details were not supplied by MSD; therefore, no reference numbers are included.

**FIGURE 58** The network diagram for combination therapy, ACR responses in severe DMARD-experienced patients as produced by Pfizer. (AiC information has been removed.)

**FIGURE 59** The network diagram for combination therapy, HAQ changes in severe DMARD-experienced patients as produced by Pfizer. (AiC information has been removed.)

**FIGURE 60** The network diagram for monotherapy, ACR responses in severe DMARD-experienced patients as produced by Pfizer. (AiC information has been removed.)

**TABLE 97** The base-case NMA results for combination therapy, ACR responses in severe DMARD-experienced patients as produced by Pfizer

AiC information has been removed	AiC information has been removed	AiC information has been removed
<b><i>AiC information has been removed</i></b>		
AiC information has been removed	AiC information has been removed	AiC information has been removed
AiC information has been removed	AiC information has been removed	AiC information has been removed
AiC information has been removed	AiC information has been removed	AiC information has been removed
AiC information has been removed	AiC information has been removed	AiC information has been removed
AiC information has been removed	AiC information has been removed	AiC information has been removed
AiC information has been removed	AiC information has been removed	AiC information has been removed
AiC information has been removed	AiC information has been removed	AiC information has been removed
<b><i>AiC information has been removed</i></b>		
AiC information has been removed	AiC information has been removed	AiC information has been removed
AiC information has been removed	AiC information has been removed	AiC information has been removed
AiC information has been removed	AiC information has been removed	AiC information has been removed
AiC information has been removed	AiC information has been removed	AiC information has been removed
AiC information has been removed	AiC information has been removed	AiC information has been removed
AiC information has been removed	AiC information has been removed	AiC information has been removed
AiC information has been removed	AiC information has been removed	AiC information has been removed
<b><i>AiC information has been removed</i></b>		
AiC information has been removed	AiC information has been removed	AiC information has been removed
AiC information has been removed	AiC information has been removed	AiC information has been removed
AiC information has been removed	AiC information has been removed	AiC information has been removed
AiC information has been removed	AiC information has been removed	AiC information has been removed
AiC information has been removed	AiC information has been removed	AiC information has been removed
AiC information has been removed	AiC information has been removed	AiC information has been removed
AiC information has been removed	AiC information has been removed	AiC information has been removed

**TABLE 98** The base-case NMA results for combination therapy, HAQ changes in severe DMARD-experienced patients, ETN vs. other bDMARDs as produced by Pfizer

AiC information has been removed	AiC information has been removed	AiC information has been removed
<b>AiC information has been removed</b>		
AiC information has been removed	AiC information has been removed	AiC information has been removed
AiC information has been removed	AiC information has been removed	AiC information has been removed
AiC information has been removed	AiC information has been removed	AiC information has been removed
AiC information has been removed	AiC information has been removed	AiC information has been removed
AiC information has been removed	AiC information has been removed	AiC information has been removed

**TABLE 99** The base-case NMA results for monotherapy, ACR responses in severe DMARD-experienced patients as produced by Pfizer

AiC information has been removed	AiC information has been removed	AiC information has been removed
<b>AiC information has been removed</b>		
AiC information has been removed	AiC information has been removed	AiC information has been removed
AiC information has been removed	AiC information has been removed	AiC information has been removed
AiC information has been removed	AiC information has been removed	AiC information has been removed
<b>AiC information has been removed</b>		
AiC information has been removed	AiC information has been removed	AiC information has been removed
AiC information has been removed	AiC information has been removed	AiC information has been removed
AiC information has been removed	AiC information has been removed	AiC information has been removed
<b>AiC information has been removed</b>		
AiC information has been removed	AiC information has been removed	AiC information has been removed
AiC information has been removed	AiC information has been removed	AiC information has been removed
AiC information has been removed	AiC information has been removed	AiC information has been removed

### Pfizer's interpretation of the network meta-analysis results

Pfizer states that for combination therapy in cDMARD-experienced severe RA patients:

*ETN was consistently significantly better than ABT IV, ADA and INF for ACR20/50/70 outcomes. Furthermore, with regards to ACR20/70 outcomes ETN was shown to be significantly better than ABT (s.c.), otherwise was similar in efficacy to CZP, GOL, and TOC.*

For combination therapy in cDMARD-experienced severe RA patients Pfizer states that:

*... though all bDMARDs had significantly lower HAQ compared with DMARD control at follow-up, none of the bDMARDs had significantly lower HAQ compared with each other.*

For cDMARD-experienced severe RA patients who are treated with monotherapy Pfizer states that:

*... based on the random-effects network meta-analysis; adalimumab, etanercept and tocilizumab have significantly higher odds of ACR 70 than placebo and etanercept and tocilizumab have significantly higher odds of ACR 50 than placebo but none of the bDMARDs are significantly better than another.*

The conclusion made by Pfizer in the executive summary is that:

*... the network meta-analysis in this submission demonstrated that etanercept is significantly better than adalimumab and infliximab for ACR20/50/70 outcomes. Furthermore, etanercept was shown to be significantly better than abatacept i.v. with regards to ACR20/50/70 outcomes and abatacept subcutaneous for ACR20/70.*

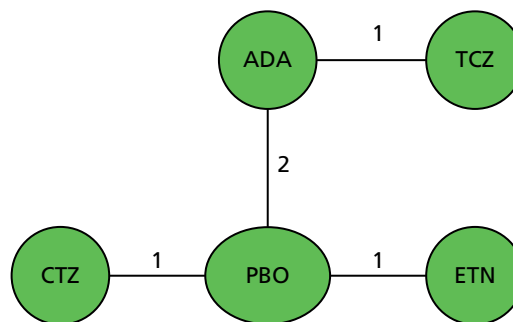
## Roche

Roche reports that:

*... the proportion of patients who fall within each response category was informed by a network meta-analysis, performed within a Bayesian framework. This meta-analysis was undertaken to allow indirect comparison of tocilizumab monotherapy with biologics currently recommended by NICE for use as monotherapy in the DMARD-IR [inadequate responder] setting.*

Figure 61 reproduces the model setup supplied by Roche. The number of trials informing each 'link' in the meta-analysis is indicated next to each line.

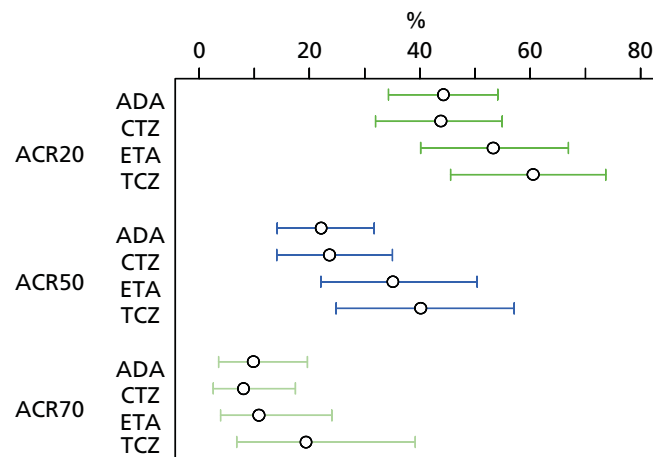
The ACR outcomes adjusted within the framework of the NMAs used within the economic model by Roche are presented in Table 100.<sup>235</sup> Unadjusted ACR rates are provided for comparison. The forest plot in Figure 62 was produced by Roche and gives an overview of the uncertainty about each estimate after adjustment in the meta-analysis.<sup>124,218,236</sup>



**FIGURE 61** The network of studies included in the meta-analysis undertaken by Roche.

**TABLE 100** American College of Rheumatology response by treatment: unadjusted and adjusted

Treatment	ACR20, %	ACR50, %	ACR70, %
Adjusted values (from NMA)			
ADA	44	22	10
CTZ	44	24	8
ETN	53	35	11
TCZ	61	40	19
Unadjusted values			
ADA	49	28	18
CTZ	44	23	7
ETN	59	40	15
TCZ	65	47	33



**FIGURE 62** Biologic monotherapy ACR responses used in the model submitted by Roche. Figure shows adjusted percentage responses from the NMA with 95% confidence intervals (CIs).

### Roche's interpretation of the network meta-analysis results

Roche state that:

*... results from the analysis suggest that tocilizumab monotherapy was associated with superior outcomes on ACR20, ACR50 and ACR70 response measures, compared with adalimumab, certolizumab pegol and etanercept monotherapy.*

### UCB Pharma

UCB Pharma undertook NMAs at both 12 and 24 weeks for each ACR response, and also for DAS28 (ESR) remission and low disease activity (24-week data only). These analyses were undertaken for both bDMARDs in combination with MTX and bDMARD monotherapy [with the exception of DAS28 (ESR) low disease activity]. The results have, however, been marked as AiC.

The results for combination therapy are shown in *Figures 63–66*. The results for monotherapy are shown in *Figures 67–70*.

**FIGURE 63** Academic-in-confidence information has been removed.

**FIGURE 64** Academic-in-confidence information has been removed.

**FIGURE 65** Academic-in-confidence information has been removed.

**FIGURE 66** Academic-in-confidence information has been removed.

**FIGURE 67** Academic-in-confidence information has been removed.

**FIGURE 68** Academic-in-confidence information has been removed.

**FIGURE 69** Academic-in-confidence information has been removed.

**FIGURE 70** Academic-in-confidence information has been removed.

### ***UCB Pharma's interpretation of the results from the network meta-analysis***

In the circumstance where a patient can receive MTX, UCB Pharma states that:

*The [NMA] conducted showed that certolizumab pegol plus MTX is at least as effective to the other comparators considered in the vast majority of cases. The RR of that certolizumab pegol plus MTX vs. comparators in combination with MTX was greater than one for all outcomes investigated for the majority of cases, which indicated better outcomes in favour of that certolizumab pegol plus MTX. The wide credible intervals noted in most of these cases reflect the minimal differences in relative clinical effect between certolizumab pegol and the comparators considered.*

In the circumstance where bDMARD monotherapy is used UCB Pharma states that:

*The [NMA] showed that certolizumab pegol was at least as effective to the other monotherapies considered. In the majority of cases, the RR [relative risk] of certolizumab pegol compared to the other monotherapies considered was greater than one, however, no differences were statistically significant.*

### **Responder criteria**

This section details the criteria to be designated a responder within the submissions. In summary, five submissions used ACR response as a measure of a responder. Three of these assumed that ACR20 measured at 24 weeks/6 months was the minimal response, one (AbbVie) assumed that an ACR50 response was required, with one (UCB Pharma) allowing an evaluation of ACR20 at either 3 or 6 months. The UCB Pharma submission used a EULAR response of moderate or good (at either 3 or 6 months) in those with moderate to severe disease. The Bristol-Myers Squibb submission assumed a DAS28 reduction of 1.2 at 6 months to designate a responder.

#### **AbbVie**

The minimal response required for continuation of treatment after the initial 6-month period is ACR50. The Assessment Group note that the comparative results for AbbVie's intervention (ADA) appears to perform relatively better using ACR50 than by using ACR20.

#### **Bristol-Myers Squibb**

Inadequate treatment is determined by the change in DAS28 – in the base case defined as DAS28 not improved by at least 1.2 by month 6. Patients who discontinue within the first 6 months would then try another first-line biologic.

#### **Merck Sharp & Dohme Corp.**

Response is defined as at least an ACR20 response at 24 weeks.

#### **Pfizer**

Patients were assumed to discontinue therapy if response (defined as at least an ACR20 response) was not achieved citing previous NICE submissions.<sup>231,237,238</sup>

#### **Roche**

Response is defined as at least an ACR20 response at 24 weeks.



## UCB Pharma

The responder definition in the submission from UCB Pharma is variable owing to the flexibility of the model. For the severe disease activity population a response of at least ACR20 is required to continue treatment. For the moderate disease activity population at least a moderate EULAR response was required. The time at which response was measured could be varied between 3 and 6 months.

### *Health Assessment Questionnaire/European Quality of Life-5 Dimensions changes in relation to response levels*

This section details how the submissions transformed response levels (ACR20, ACR50 and ACR70, and good, moderate and no EULAR response) to changes in HAQ or EQ-5D. In summary, the majority of submissions assessed the associated HAQ score change with response levels from their own data and then assumed that this was applicable to all bDMARDs. All submissions showed that a greater response was associated with a greater HAQ score reduction. UCB Pharma used EQ-5D data recorded within their trials to model the improvement post response. There was not a consistent approach to modelling how the response was assumed to be accumulated. In some cases the response at 6 months was assumed to be experienced throughout the 6-month response period; in others, it was assumed that responses developed linearly or the full effect was applied but a one-off reduction was modelled to assume that the HAQ improvement would not be observed immediately.

## AbbVie

AbbVie assumed that the HAQ change by ACR response for all bDMARDs would be the same as for ADA, whereas the changes associated with cDMARDs would be the same as for MTX.

Health Assessment Questionnaire changes are divided into the initial response period (defined as either 12 or 24 weeks) and then from the response period until 52 weeks. The base case assumes a 24-week response period.

Health Assessment Questionnaire changes are assumed to be linear until the response period and linearly between the response period and week 52.

Inputs for the MTX-naive patients were based on the DE013<sup>109</sup> trial (AbbVie, data on file) and those for MTX-experienced patients were from the Efficacy and Safety of Adalimumab in Patients With Active Rheumatoid Arthritis Treated Concomitantly With Methotrexate (DE019<sup>84</sup>) trial (AbbVie, data on file). AbbVie reports that data specific for monotherapy were not available in DE019 trial thus an assumption was made that the relative HAQ changes for monotherapy in MTX-experienced patients were similar to those observed in the MTX-naive patients (i.e. DE013). As sample sizes were deemed insufficient for analysis of relative changes in HAQ by stage or RA (moderate or severe), data were pooled for moderate and severe patients.

*Tables 101–103* reproduce the data supplied by AbbVie.

**TABLE 101** The relative change reported by AbbVie in HAQ score by ACR response by treatment: moderate and severe RA, MTX experienced for bDMARD + MTX

ACR response	ADA + MTX			MTX		
	Mean % change	SD	<i>n</i>	Mean % change	SD	<i>n</i>
<b>Baseline to 24 weeks</b>						
ACR < 20	-13.7	72.5	41	-5.6	57.6	88
ACR20 to < 50	-38.6	33.0	52	-31.5	33.6	41
ACR50 to < 70	-55.7	30.1	42	-55.5	30.3	14
ACR70 to 100	-80.0	22.5	38	-74.0	31.7	6
<b>24-52 weeks</b>						
ACR < 20	4.7	45.4	32	-3.2	44.2	74
ACR20 to < 50	-2.1	73.5	41	5.5	45.7	34
ACR50 to < 70	-12.8	51.7	33	2.8	32.1	11
ACR70 to 100	-40.0	48.6	17	-22.9	14.7	2

Source: DE019 pooled data for moderate ( $3.2 < \text{DAS28} \leq 5.1$ ) and severe ( $\text{DAS28} > 5.1$ ) disease activity.

**TABLE 102** The relative change reported by AbbVie in HAQ score by ACR response by treatment: severe RA, MTX naive for bDMARD + MTX

ACR response	ADA + MTX			MTX		
	Mean % change	SD	<i>n</i>	Mean % change	SD	<i>n</i>
<b>Baseline to 24 weeks</b>						
ACR < 20	-30.4	43.0	36	-27.9	36.2	48
ACR20 to < 50	-53.1	38.5	41	-43.3	45.2	53
ACR50 to < 70	-61.8	31.9	51	-53.7	44.2	52
ACR70 to 100	-83.6	24.0	108	-82.9	22.7	62
<b>24-52 weeks</b>						
ACR < 20	-25.2	28.5	26	10.7	104.2	35
ACR20 to < 50	-12.1	40.9	24	-4.6	58.2	42
ACR50 to < 70	-28.8	62.5	34	-11.4	47.9	43
ACR70 to 100	-14.5	80.2	50	-24.6	60.3	28

Source: DE013 (PREMIER<sup>109</sup>) pooled data for moderate and severe (AbbVie data on file).

**TABLE 103** The relative change reported by AbbVie in HAQ score by ACR response by treatment: moderate and severe RA, MTX experienced or naive for bDMARD monotherapy

ACR response	ADA			MTX		
	Mean % change	SD	<i>n</i>	Mean % change	SD	<i>n</i>
<b>Baseline to 24 weeks</b>						
ACR < 20	-18.7	43.6	70	-27.9	36.2	48
ACR20 to < 50	-45.8	33.8	50	-43.3	45.2	53
ACR50 to < 70	-68.0	26.8	48	-53.7	44.2	52
ACR70 to 100	-83.2	23.7	52	-82.9	22.7	62
<b>24–52 weeks</b>						
ACR < 20	-10.1	41.9	50	10.7	104.2	35
ACR20 to < 50	22.2	112.3	38	-4.6	58.2	42
ACR50 to < 70	31.1	135.8	35	-11.4	47.9	43
ACR70 to 100	54.0	199.7	22	-24.6	60.3	28

Source: DE013 (AbbVie data on file) pooled data for moderate and severe.

### Bristol-Myers Squibb

Bristol-Myers Squibb provides a table that details the assumed reduction in HAQ. This is reproduced in *Table 104*. The Assessment Group comments that it has been assumed that the HAQ reduction for cDMARDs used after bDMARDs was halved; however, the data for bDMARDs used after an initial bDMARD appear to generally perform better than the same bDMARD used first line.

Bristol-Myers Squibb reports that as the improvement in HAQ-DI score on starting each treatment would actually be more gradual than a sudden decrease, 'start and end effects' are applied as a one-off deduction in QALYs on starting and ending each treatment. This deduction is equal to 20% of the increase in quality of life. No justification for this value was provided.

### Merck Sharp & Dohme Corp.

Merck Sharp & Dohme Corp. presents EQ-5D data for patients dependent on their health state (non-responder; ACR20; ACR50; ACR70). These values have been calculated with the HAQ score being transformed to a utility using the equation of Hurst *et al.*<sup>241</sup> Substantially different values are provided for the GOL submission and for the IFX submission, with these data being assumed to apply to all interventions in the relevant submission. MSD does not comment on this discrepancy.

### Golimumab data

*Table 105* provides data on the assumed utility for each health state. These data have been taken from GO-FORWARD<sup>216</sup> and GO-FORTH<sup>91</sup> for the DMARD-experienced population and from GO-FORWARD<sup>216</sup> for the severe subgroup. These values have been calculated by the HAQ score being used within the Hurst *et al.* mapping.<sup>241</sup>

### Infliximab data

*Table 106* provides data on the assumed utility for each health state. These data have been taken from START<sup>118</sup> and ATTRACT<sup>75</sup> for the DMARD-experienced population and from ATTRACT<sup>75</sup> for the severe subgroup. These values have been calculated by the HAQ score being used within the Hurst *et al.* mapping.<sup>241</sup>

**TABLE 104** The assumed reduction in HAQ detailed by Bristol-Myers Squibb

Treatment	HAQ (reduction) change from baseline, mean	HAQ change from baseline, SE	Source
<b>First-line biologics</b>			
ABT i.v.	0.344	0.063	Bristol-Myers Squibb NMA (2013) <sup>208</sup>
ABT s.c.	0.332	0.112	
ADA	0.326	0.077	
ETN	0.279	0.097	
IFX	0.199	0.063	
TCZ	0.213	0.100	
GOL	0.333	0.112	
CTZ	0.386	0.069	
<b>Second-line biologics</b>			
ABT i.v.	0.5	0.05	Malottki <i>et al.</i> , 2011 <sup>171</sup>
ADA	0.48	0.048	Malottki <i>et al.</i> , 2011 <sup>171</sup>
ETN	0.35	0.035	Malottki <i>et al.</i> , 2011 <sup>171</sup>
IFX	0.35	0.035	Malottki <i>et al.</i> , 2011 <sup>171</sup>
TCZ	0.39	0.039	Strand <i>et al.</i> , 2012 <sup>239</sup>
GOL	0.25	0.025	Smolen <i>et al.</i> , 2009 <sup>240</sup>
RTX	0.4	0.04	Malottki <i>et al.</i> , 2011 <sup>171</sup>
<b>DMARDs</b>			
LEF	0.24	0.024	Chen <i>et al.</i> , 2006 <sup>123</sup> – halved
GLD	0.2	0.02	Chen <i>et al.</i> , 2006 <sup>123</sup> – halved
CYC	0.2	0.02	Chen <i>et al.</i> , 2006 <sup>123</sup> – halved
AZA	0.1	0.01	Chen <i>et al.</i> , 2006 <sup>123</sup> – halved

SE, standard error.  
 For second-line biologics and DMARDs, the SD is assumed to be 10% of the mean.  
 Malottki *et al.*<sup>171</sup> assumed halved the change in HAQ-DI from Chen *et al.*<sup>123</sup> as this was for an earlier line indication.  
 Data are shown to the level of accuracy available in the source material.

**TABLE 105** Utility assumed by health state by MSD in the GOL submission

Health state	DMARD experienced	DMARD-experienced severe subgroup (DAS $\geq$ 5.1) (GO-FORWARD <sup>216</sup> )
Baseline	0.401	0.355
GOL-treated non-responder	0.461	0.362
GOL-treated ACR20	0.581	0.636
GOL-treated ACR50	0.638	0.689
GOL-treated ACR70	0.787	0.790

**TABLE 106** Utility assumed by health state by MSD in the IFX submission

Health state	DMARD experienced	DMARD-experienced severe subgroup (DAS28 > 5.1) (ATTRACT <sup>75</sup> )
Baseline	0.282	0.271
IFX-treated non-responder	0.307	0.290
IFX-treated ACR20	0.462	0.452
IFX-treated ACR50	0.568	0.554
IFX-treated ACR70	0.684	0.660

## Pfizer

Pfizer presents the HAQ improvement associated with each of four response levels: no ACR response; ACR20; ACR50; and ACR70. Pfizer states that following a systematic review only one reference allowed separate estimates to be made for cDMARD-inadequate responders and bDMARD-inadequate responders.<sup>231</sup>

This source permitted the estimation of HAQ change associated with each ACR response category separately for both cDMARD-inadequate responders (first line within a treatment sequence) and bDMARD-inadequate responders (second and subsequent lines within a treatment sequence). *Table 107* presents the estimates of HAQ improvement used in cDMARD-inadequate responders and bDMARD-inadequate responders. Pfizer notes that this approach may lead to further uncertainty in the model due to the extra mapping function, so a comparison using available HAQ data from the NMA was undertaken as a sensitivity analysis.

## Roche

The Roche analysis assumes that response to treatment has an impact on disease severity (as measured by individual HAQ score). Data from ADOCTA<sup>236</sup> were analysed to estimate the relationship between ACR response and individual HAQ score for the first 24 weeks. The data from the first 24 weeks of the study suggest that the higher the observed ACR response the greater the drop in HAQ score. *Table 108* presents the individual HAQ score drop per ACR response and the corresponding standard errors (SEs).

For every response to a new treatment, the model applies the corresponding HAQ score reduction to every simulated individual during the first cycle on treatment (first 6 months). The relationship between ACR response and initial HAQ drop is assumed to be conditional only to ACR response; it is applied universally to all interventions.

**TABLE 107** The HAQ improvement by ACR response category reported by Pfizer

ACR response	cDMARD-IR		bDMARD-IR	
	Mean	SE	Mean	SE
No response	0.136	0.017	0.098	0.022
ACR20	0.443	0.018	0.405	0.034
ACR50	0.668	0.026	0.670	0.058
ACR70	0.923	0.032	0.949	0.064

IR, inadequate responder; SE, standard error.

**TABLE 108** Improvement in HAQ score associated with ACR response assumed by Roche

AiC information has been removed	AiC information has been removed	AiC information has been removed	AiC information has been removed
AiC information has been removed	AiC information has been removed	AiC information has been removed	AiC information has been removed
AiC information has been removed	AiC information has been removed	AiC information has been removed	AiC information has been removed
AiC information has been removed	AiC information has been removed	AiC information has been removed	AiC information has been removed
AiC information has been removed	AiC information has been removed	AiC information has been removed	AiC information has been removed

### UCB Pharma

UCB Pharma recorded EQ-5D data within the RAPID trials<sup>135,136</sup> which were used for patients with severe RA and within the CERTAIN<sup>79</sup> study for those with moderate to severe RA. These are detailed in *Table 109*, although the data for CERTAIN<sup>79</sup> were marked as AiC.

The data for the severe population were calculated using a regression analysis of EQ-5D versus ACR in RAPID trials;<sup>135,136</sup> no further information was provided.

The data for the severe population were calculated using a regression analysis of (AiC information has been removed).

### Health Assessment Questionnaire trajectory following initial response

This section details the HAQ trajectory post the initial response. In summary, the majority of submissions use data from previous NICE appraisals although the Assessment Group comments that the evidence base for these values is very limited. Given that HAQ progression is linked in the majority of models to utility, disease costs and mortality, any inaccuracies in the projected HAQ trajectories could have a marked impact on the results.

### AbbVie

AbbVie reports that, in line with current NICE guidance on the use of ADA, ETN and IFX for the treatment of RA,<sup>207</sup> the model assumes different levels of HAQ progression for patients receiving antiTNF therapy, cDMARD therapy and non-responders after 1 year. The assumption on long-term HAQ-DI progression while on biological therapy is based on the results of a variety of long-term studies on ADA and ETN.<sup>110,242,243</sup> Two sensitivity analyses were undertaken changing the HAQ progression while on bDMARDs to 0.030 and the HAQ progression on cDMARDs to 0.030. These data are shown in *Table 110*.

**TABLE 109** The EQ-5D data reported by UCB Pharma associated with response level

Severe RA population		Moderate to severe RA population	
No response	0.062	AiC information has been removed	AiC information has been removed
ACR20	0.173		
ACR50	0.238		
ACR70	0.358		

**TABLE 110** Absolute annual HAQ-DI progression assumed by AbbVie

Intervention	Base case	HAQ-DI progression	
		Scenario 1	Scenario 2
Biologic therapy	0.000	0.030	0.000
cDMARD	0.045	0.045	0.030
Non-responders	0.060	0.060	0.060

### Bristol-Myers Squibb

Bristol-Myers Squibb assumes that the HAQ score increases (clinically worsens) gradually over time while the patient is receiving treatment with DMARDs or palliative care. This is modelled as an increase of 0.125 every 2.7 years on DMARDs and of 0.125 every 2 years on palliative care. It is assumed that patients on bDMARDs have a constant HAQ. These assumptions are based on Malottki *et al.*<sup>171</sup>

### Merck Sharp & Dohme Corp.

In the MSD model the HAQ score declines at a rate of 0.045 per year if a patient is receiving cDMARDs. Patients receiving palliative care have an assumed HAQ progression of 0.06 per year. The model assumes that bDMARD treatment halts disease progression and thus the HAQ progression per year is 0.00. This assumption is aligned with comments from the NICE TA TA130,<sup>207</sup> which states that it is 'appropriate to primarily examine the estimates of cost-effectiveness based on the assumption of no HAQ progression while on TNF- $\alpha$  inhibitor therapy, while acknowledging the effects on the estimates of incorporating different assumptions of HAQ progression' and assumes the same holds true for the other bDMARDs.

### Pfizer

Pfizer assumes an annual HAQ progression rate of 0.00 for bDMARDs, 0.046 for cDMARDs and 0.06 per year for palliative care, citing that these values have been used in previous NICE appraisals.

Different rates of HAQ progression were explored as sensitivity analyses in both moderate to severe and severe naive populations.

Scenario analysis within the moderate to severe population uses rates of progression observed within PRESERVE<sup>217</sup> period 2, weeks 36–88. Rates of progression in period 2 of PRESERVE<sup>217</sup> were greater for MTX than those used in previous economic evaluations. Rates of HAQ for ETN plus MTX initially increase in the first 4 weeks after randomisation, but then stabilise from week 40 to week 88, suggesting little or no further HAQ progression over this period. HAQ change from weeks 36, 40 and 56 to week 88 for both ETN plus MTX and MTX alone has been included in the sensitivity analyses.

Scenario analysis within the severe naive population uses rates of progression from period 2 of COMET<sup>81</sup> (weeks 52–104). (CiC information has been removed.)

A further scenario analysis within the all populations uses rates of progression (0.031 for cDMARDs and 0.0102 for bDMARDs) observed by Scott *et al.*<sup>244</sup>

### Roche

Roche reports that there is a dearth of evidence on the changes a patient's condition undergoes while on treatment. Moreover, there are no available data from the Roche clinical trials (ACT-RAY<sup>213</sup> and ADACTA<sup>57,236</sup>) following the first 24 weeks (first cycle).

For these reasons Roche states that its model uses evidence in previous submissions to NICE. The model assumes no HAQ score progression for all treatments while patients continue responding. For patients in palliative care, a per-cycle HAQ score progression (worsening) of 0.03 is assumed. These data are shown in *Table 111*.

**TABLE 111** Health Assessment Questionnaire progression while on treatment after the initial 24-week period assumed by Roche

Treatment	HAQ score change per 6-month cycle	Source
bDMARDs	0.00	NICE TA130 <sup>207</sup>
Palliative care	0.03	NICE TA130 <sup>207</sup>

### UCB Pharma

In the UCB Pharma model it was assumed that HAQ would decrease at a rate of 0.1913 per annum while on treatment, but increase by 0.048 per annum when a second-line bDMARD was used. However, it appears that there are typographical errors within the model as the 6-month response on bDMARDs was half that of the 3-month response, and the changes at 3 months and 6 months for follow-up biologics were equal. For patients on palliative care or cDMARDs, HAQ progression was assumed to be 0.06 per annum. UCB Pharma cites previous NICE guidance for these figures, except the HAQ change on first-line treatment, which was calculated from data on file.

### Time to discontinuation of treatment

This section details the methods used by the manufacturers to determine when a patient discontinued treatment. In summary, a multitude of methods were used by the manufacturers.

### AbbVie

Time-to-treatment discontinuation curves from Edwards *et al.*<sup>245</sup> (based on General Practice Research Database data) were used to model overall withdrawal (due to any reasons) while on cDMARDs. AbbVie states that these curves, although somewhat dated, have been judged as representative of withdrawal patterns from non-bDMARDs today by a practising UK rheumatologist, although it was indicated that withdrawal due to HCQ was not expected to be so low. Assumptions were made for combination DMARDs not examined by Edwards *et al.*<sup>245</sup> that time on treatment would be similar to time on treatment with MTX.

The digitised curves (reading in 90+ points from each curve) were used to create mock patient-level data, following the method of Hoyle and Henley<sup>246</sup> when number of patients at risk was available (antiTNFs), and Tierney *et al.*<sup>247</sup> when number of patients at risk is unavailable (DMARDs). Parametric survival models were estimated using SAS (SAS Institute Inc., Cary, NC, USA) [and Stata (StataCorp LP, College Station, TX, USA) for Gompertz], and provided parameter estimates and variance–covariance matrices. For the time-to-treatment discontinuation data the exponential, Weibull, Gompertz, log-normal, log-logistic and gamma survival models were estimated. The gamma model was estimated only for information purposes, as the Arena model submitted by AbbVie cannot generate samples from it. The fits of the curves were compared visually, as well as using the Akaike information criterion and Bayesian information criterion.

Curves for MTX, SSZ and HCQ in the Edwards *et al.*<sup>245</sup> study were fitted best by the log-normal function and these were, therefore, used for modelling time on treatment. The fitted curves to the data are shown in *Table 112*. The correlation between the parameters was not provided in the report.

AbbVie states that:

*... for anti-TNFs, separate withdrawal curves by reason either through adverse or lack of efficacy are presented in the published literature. Modelling these two reasons separately allows more flexibility in modelling the time on treatment and corresponds to the new treat to target paradigm; for patients on non-biologic DMARDs, they would be evaluated monthly and could start dropping off immediately, while for those on biologics, patients would have to stay on the drug for at least three to six months for the assessment of response.*<sup>248</sup>



**TABLE 112** The estimated log-normal curve for cDMARD withdrawal rate calculated by AbbVie

Treatment	Lambda		Gamma	
	Mean	SE	Mean	SE
MTX	2.1163	0.0531	2.8986	0.0472
MTX + HCQ <sup>a</sup>	2.1163	0.0531	2.8986	0.0472
SSZ + HCQ <sup>a</sup>	2.1163	0.0531	2.8986	0.0472
LEF <sup>a</sup>	2.1163	0.0531	2.8986	0.0472
HCQ	0.4165	0.0802	2.1706	0.0674
SSZ	0.6336	0.0303	2.4548	0.0259
CYC <sup>b</sup>	0.6336	0.0303	2.4548	0.0259

CYC, ciclosporin.

a Assume similar time on treatment as MTX.

b Assume similar time on treatment as SSZ.

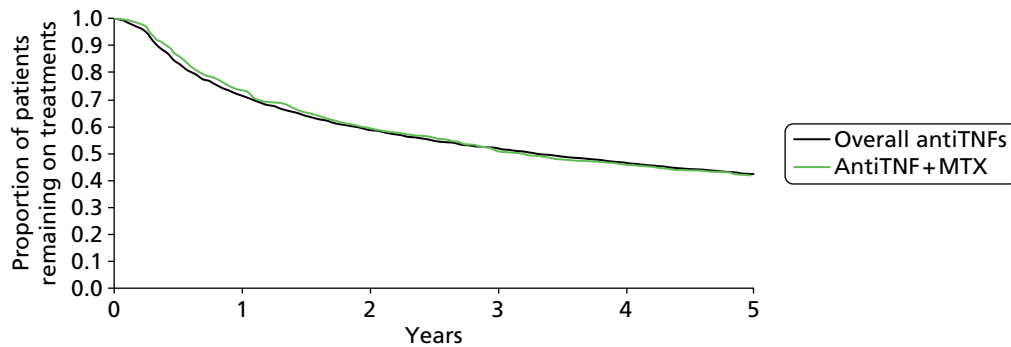
Patients on biologics are subjected to risk of withdrawal due to AEs immediately after start of therapy based on analysis of BSRBR data presented in Soliman *et al.*<sup>249</sup> The same withdrawal pattern was assumed applicable for all biologic therapies including antiTNFs due to lack of data on the newer biologics not included in BSRBR, the lack of recent comparative data across antiTNFs in BSRBR, and conflicting comparative withdrawal evidence about the antiTNFs in the international literature.<sup>250,251</sup> Biologic monotherapy was assumed to have a higher withdrawal rate due to AEs (evidenced by a recent BSRBR-based analysis, Soliman *et al.*<sup>249</sup>).

AbbVie comments that although the Cochrane review found evidence of differences among clinical trials of biologics, various design elements (e.g. mandatory and optional early escape in some but not all trials) make it difficult to compare withdrawal and to generalise trial results for long-term withdrawal patterns.

The Gompertz model fitted best in the AbbVie analyses for the AE-specific withdrawal data from BSRBR for all antiTNFs presented by Soliman *et al.*<sup>249</sup> It assumes that after approximately 9 years on biologic treatment, there would be no further withdrawals due specifically to AEs (i.e. all long-term withdrawals are due to lack of efficacy). This was consistent with the experience of a UK practising clinician consulted by AbbVie. AbbVie stated that since the Gompertz survival model is a proportional hazard model, published reason-specific adjusted hazard ratios (HRs) in the same study for the antiTNF monotherapy versus antiTNF combination therapy with MTX have been applied to obtain monotherapy withdrawal curves.<sup>249</sup> The paper did not present reason-specific Kaplan–Meier curves for antiTNFs as monotherapy versus antiTNF plus MTX specifically. The assumption used was that overall the antiTNF AE withdrawal curve is identical to the combination therapy AE withdrawal curve. This assumption is supported by data from the study in which similar proportions of patients discontinued the treatment due to AEs at year 5, this was shown between those receiving antiTNFs in combination with MTX and the overall antiTNF cohort (28% vs. 29%, see Table 2 in Soliman *et al.*<sup>249</sup>). In addition, the Kaplan–Meier curves of the observed overall persistence between these two groups run very close to each other (Figure 71). Parameter estimates for modelling of withdrawals due to AEs for biologics are shown in Soliman *et al.*<sup>249</sup>

Table 113 provides data on withdrawals from bDMARD therapy due to AEs. The correlation between the parameters was not provided in the report.

Data on withdrawal due to lack of efficacy have been presented for overall antiTNF groups by the same study.<sup>249</sup> This curve starts sloping downwards at around 3 months, and the slope is very flat (i.e. there is no evidence of a stopping rule being applied despite clinical guidance on stopping patients on biologic therapy if adequate response is not observed at 6 months).<sup>248</sup>



**FIGURE 71** Kaplan–Meier estimates of the observed persistence with all antiTNFs and with the combination therapy of antiTNFs and MTX in BSRBR.

**TABLE 113** Parameter estimates for biologic treatment withdrawal due to AEs (Gompertz function) calculated by AbbVie

Treatment	Lambda		Gamma	
	Mean	SE	Mean	SE
Combination with MTX	-1.5164	0.0308	-0.6247	-0.0005
Monotherapy	-1.1311 <sup>a</sup>	0.0308	-0.6247	-0.0005

<sup>a</sup> Estimated by applying the published adjusted HR of 1.47 to the lambda parameter of the combination therapy.<sup>24</sup>

In the AbbVie base case, the model applies a stopping rule based on response rates; all those without an ACR50 or ACR20 (in a sensitivity analysis) response would be stopped at a given time (i.e. 12 or 24 weeks). AbbVie state:

*... therefore, the initial part of the withdrawal curve due to lack of efficacy from BSRBR is ignored. The differences in response rates would result in differential withdrawal due to lack of efficacy on biologics, including monotherapy versus combination therapy (i.e., with MTX); no additional adjustment would be applied. Beyond the time point of response assessment, the lack of efficacy curves from BSRBR would be applied to allow for further drop out due to lack of efficacy. In other words, the model predicts a time to withdrawal due to lack of efficacy for all patients in the simulation when each treatment is initiated. If the time predicted is earlier than the stopping rule (i.e., 12 or 24 weeks), it is ignored. If it is later than the stopping rule, and the patient is a responder not stopping treatment at e.g., 12 or 24 weeks, they would be withdrawn at that time.*

For withdrawal beyond the non-responder withdrawal (i.e. at 12 or 24 weeks), the same curve is applied across all biologics.

Because the flat initial part of the withdrawal due to loss of efficacy curve is flat, AbbVie report that no survival model provided a good fit to the overall data. However, the fit was much improved when the flat part of the curve for the initial 3.337 months was removed from the data. The best fit for the truncated data was provided by the log-normal function. Time to withdrawal due to lack of efficacy predicted from these parameters was added back by 3.337 months in the simulation. *Table 114* provides the parameter estimates given by AbbVie. The correlation between the parameters was not provided in the report.

**TABLE 114** Parameter estimates for biologics treatment withdrawal due to loss of efficacy (log-normal function) provided by AbbVie

Treatment	Lambda		Gamma	
	Mean	SE	Mean	SE
Biologics	3.1171	0.0643	3.0225	0.0512

### Bristol-Myers Squibb

The probabilities of AEs assumed by Bristol-Myers Squibb are shown in *Table 115*. The source for these data appears to be a NMA of AEs undertaken within the Bristol-Myers Squibb submission. As with the NMA for comparative efficacy the reporting of the NMA assumptions is lacking.

For all first-line biologic treatments, if an AE had not been simulated then time on treatment is sampled from a Weibull distribution with shape parameter 0.71 and scale parameter 7.06, giving a mean time on treatment 4.21 years (Bristol-Myers Squibb's submission document to NICE for TA234<sup>38</sup>).

Bristol-Myers Squibb assumes that the probability of having an AE on RTX is 3.54%, as 17 of 480 patients discontinued due to AEs in the REFLEX study.<sup>252</sup> If the patient does not discontinue treatment with RTX at 6 months, their long-term time on RTX is sampled from a Weibull distribution with shape 0.474 and scale 5.1.<sup>171</sup>

Malottki *et al.*<sup>171</sup> considered i.v. ABT, ADA, ETN, IFX and RTX, so Bristol-Myers Squibb state that it was necessary to find inputs for s.c. ABT, GOL and TCZ. s.c. ABT was assumed to have the same efficacy and safety profile as i.v. ABT. The early withdrawal inputs for GOL and TCZ came from the GO-AFTER study<sup>253</sup> and the RADIATE study<sup>254</sup> respectively. GOL is an antiTNF, so the long-term time on treatment is assumed to be the same as that of the other antiTNFs (ADA, ETN and IFX) as reported by Malottki *et al.*<sup>171</sup> TCZ is not an antiTNF, but, in the absence of data, the long-term time on treatment is assumed to be the same as that of the antiTNFs. Inputs for short- and long-term time on treatment are shown in *Tables 116* and *117* respectively.

Third-line TCZ use was assumed to have the same rate of AEs and time to withdrawal as second-line TCZ treatment.

**TABLE 115** The probability of AE for first-line biologics assumed by Bristol-Myers Squibb

Treatment	At month 6/week 24: probability of AE
ABT i.v.	0.023
ABT s.c.	0.016
ADA	0.041
ETN	0.030
IFX	0.086
TCZ	0.041
GOL	0.020
CTZ	0.096

**TABLE 116** The probability of early discontinuation on second-line biologics as estimated by Bristol-Myers Squibb

Treatment	Parameter	Point estimate (%)
ADA	Probability of withdrawal at 12 weeks	9.9
	Proportion of the discontinuations at 12 weeks that are due to ineffectiveness	56.2
ETN	Probability of withdrawal at 13 weeks	5.2
	Proportion of the discontinuations at 13 weeks that are due to ineffectiveness	16.7
IFX	Probability of withdrawal at 16 weeks	23
	Proportion of the discontinuations at 16 weeks that are due to ineffectiveness	66.7
ABT	Probability of withdrawal at 24 weeks	13.6
	Proportion of the discontinuations at 24 weeks that are due to ineffectiveness	25.7
TCZ	Probability of withdrawal at 24 weeks	14.7
	Proportion of the discontinuations at 24 weeks that are due to ineffectiveness	64.5
GOL	Probability of withdrawal at 24 weeks	12.4
	Proportion of the discontinuations at 24 weeks that are due to ineffectiveness	72.0

**TABLE 117** The long-term time on second-line biologics as estimated by Bristol-Myers Squibb

Treatment	Weibull shape parameter	Weibull scale parameter	Mean (years)
ADA	0.701	3.21	4.06
ETN	0.701	3.21	4.06
IFX	0.701	3.21	4.06
ABT	0.81	5.49	6.17
TCZ	0.701	3.21	4.06
GOL	0.701	3.21	4.06

Data are shown to the level of accuracy available in the source material.

For cDMARDs, Bristol-Myers Squibb used data reported by Malottki *et al.*<sup>171</sup> These data are reproduced in *Tables 118* and *119*.

### Merck Sharp & Dohme Corp.

Merck Sharp & Dohme Corp. states that no studies with sufficient follow-up were identified for GOL, ADA, CTZ, TCZ or ABT and thus these were all set equivalent to IFX. This is stated to be a very conservative assumption for GOL given that the drop-out rate after 52 weeks of GOL (50 mg) is very low in the GO-FORWARD clinical trial,<sup>216</sup> only 6% at week 52. The long-term drop-out rates for the other bDMARDs from clinical trials were stated to be more aligned with the evidence available for IFX. Keystone *et al.*<sup>84</sup> report comparable drop-out rates at week 52 with those observed in a 52-week trial for IFX.

A summary of the probability of discontinuation due to long-term loss of efficacy parameters used by MSD is shown in *Table 120*. The probability of remaining on treatment at a given month ( $x$ ) was estimated from *Equation 17*:

$$P(\text{remaining on treatment}) = \exp(-\lambda \times x^\gamma). \quad (17)$$

**TABLE 118** The probability of early discontinuation cDMARDs as assumed by Bristol-Myers Squibb

Treatment	Parameter	Point estimate (%)
LEF	Probability of withdrawal at 6 weeks	13
	Probability of withdrawal at 6–24 weeks	30
	Proportion of the discontinuations at 24 weeks that are due to ineffectiveness	33.2
GLD	Probability of withdrawal at 6 weeks	14
	Probability of withdrawal at 6–24 weeks	27.1
	Proportion of the discontinuations at 24 weeks that are due to ineffectiveness	66.7
CYC	Probability of withdrawal at 6 weeks	8
	Probability of withdrawal at 6–24 weeks	24
	Proportion of the discontinuations at 24 weeks that are due to ineffectiveness	50
AZA	Probability of withdrawal at 6 weeks	15
	Probability of withdrawal at 6–24 weeks	25
	Proportion of the discontinuations at 24 weeks that are due to ineffectiveness	50

**TABLE 119** Long-term time on cDMARDs as assumed by Bristol-Myers Squibb

Treatment	Alpha Weibull parameter	Beta Weibull parameter	Mean (years)
LEF	1	5.98	5.98
GLD	0.48	1.81	3.91
CYC	0.5	4.35	8.70
AZA	0.39	4.35	15.53

Data are shown to the level of accuracy available in the source material.

**TABLE 120** Time-to-treatment withdrawal assumed by MSD

Long-term discontinuation due to loss of efficacy			
Treatment	Lamda	Gamma	Mean (years)
GOL	0.103	0.532	9
ADA	0.103	0.532	9
IFX	0.103	0.532	9
ETN	0.027	0.738	12
CTZ	0.103	0.532	9
TCZ	0.103	0.532	9
ABT i.v.	0.103	0.532	9
ABT s.c.	0.103	0.532	9
MTX	0.091	0.438	20

## Pfizer

Pfizer used 5-year data from the ETN cohort of the BSRBR to estimate treatment cessation. This was selected because it represented the most appropriate long-term evidence available. Calculations in the ETN cohort were made separately for combination and monotherapy patients. Severe disease status (relative to moderate to severe disease status) was included within the analysis as a covariate, allowing separate estimates of treatment cessation for both severe and moderate to severe populations.

Although Pfizer acknowledges the limitations of the use of the ETN BSRBR cohort in the moderate to severe population, in the absence of any long-term data in this population these estimates were considered the best available. It is hypothesised that such patients may be at greater risk of progression than a more representative moderate to severe population, and therefore treatment cessation may be overestimated within this cohort. In the absence of data in the severe DMARD-naïve patient population, treatment discontinuation was assumed to be equivalent to that of the severe DMARD-inadequate responder combination therapy population.

Parametric survival curves were fitted to the data with the log-logistic distribution found to provide the best fit to data based on the AIC.<sup>255</sup> *Figure 72* presents the estimated cumulative hazard of treatment cessation versus the observed treatment cessation for the ETN BSRBR cohort, both combination and monotherapy, although these are marked as CiC.

Data for treatment discontinuation were not accessible for comparator therapies from the BSRBR. Therefore, an observational study by Hetland *et al.*<sup>250</sup> was selected that presented Kaplan–Meier curves for all-cause treatment cessation for ETN, IFX and ADA from the DANBIO registry,<sup>256</sup> which was considered the most similar to the UK population from registries identified in a Pfizer systematic review. Curves were digitised using Engauge Digitizer and a pseudo-patient-level data set was created for all three therapies.<sup>246,257,258</sup> These data sets were used to fit log-logistic parametric survival models that provided relative treatment effects for both IFX and ADA versus ETN (*Figure 73*).

These relative effects were applied to the baseline estimates for ETN from the BSRBR in order to generate time-on-treatment estimates for IFX and ADA.

In the absence of long-term data for other therapies, the relative effect for ADA was assumed by Pfizer to apply to CTZ and GOL, on the basis that they are also monoclonal antibodies. TCZ, i.v. ABT, s.c. ABT and RTX were conservatively assumed to share the same time on treatment as ETN. A scenario analysis was performed by Pfizer in which there was assumed to be no difference in treatment cessation between bDMARDs.

A cDMARD curve was also generated from the BSRBR control cohort, and this was used for all cDMARDs. Severe disease status (relative to moderate to severe disease status) was also included within the analysis as a covariate. *Figure 74* presents the time on treatment assumptions graphically for the severe DMARD-inadequate responder combination therapy population.

---

**FIGURE 72** Commercial-in-confidence information has been removed.

---

**FIGURE 73** The fitted log-logistic survival distributions estimated by Pfizer. (AIC information has been removed.)

---

**FIGURE 74** Commercial-in-confidence information has been removed.

As Pfizer believes it is difficult to appreciate differences in treatment cessation across all therapies within *Figure 74*, the same data are presented as a conditional inference tree in *Figure 75*. A conditional inference tree performs univariate partitioning of the simulated times to treatment cessation by using a significance test procedure in order to identify differences between time on treatment by therapy. Differences in treatment cessation are identified where partitioning occurs. There are four resulting patterns of 'times' based on the assumptions described previously: IFX; cDMARD; those based on that of ADA (CTZ and GOL); and those based on that of ETN (ABT i.v., ABT s.c., TCZ and RTX).

The resulting treatment cessation curves for the model first-line therapy were adjusted by Pfizer to reflect the increased risk of cessation in subsequent lines of therapy. The (log) time ratio for second- versus first-line therapy was estimated as  $-0.365$  using the same methodology of patient-level data set generation as described above, with data taken from DANBIO.<sup>256</sup> This effect was applied in all subsequent lines of therapy and to all therapies (including cDMARDs). *Figure 75* presents a comparison of original data and model output. Note that the model output here does not include the effects of the treatment discontinuation rule. The model by default actually models time to start of next therapy (rather than end of current therapy); in order to provide a representative comparison, the time between cessation of RTX therapy and the start of the next therapy was ignored in the generation of *Figure 76*. The model was able to recreate the effects of second- and subsequent-line treatment cessation accurately.

Treatment cessation data used in the model are presented in *Table 121*. Times were generated stochastically for each patient using a random number combined with the inverse survival distributions.<sup>180</sup>

## Roche

The Roche model assumes that all patients receive each treatment for a minimum of one cycle, until response is evaluated. This is consistent both with previous evidence submissions and with the available efficacy evidence. At 6 months, patients will continue on their first therapy, providing they achieved a response greater than or equal to ACR20. Therapy is stopped for a non-responding patient and they move on to the next drug.

Soliman *et al.*<sup>249</sup> published an analysis of treatment duration using BSRBR data (large cohort with  $n = 10,396$ ). A proportion of these patients do not receive any concomitant DMARD treatment (32.1%,  $n = 3339$ ) and this fact was used in the economic analysis as a basis for estimating the withdrawal risk of patients receiving biologic monotherapy.

Roche provided a Kaplan–Meier curve showing treatment persistence with antiTNF. A Weibull and an exponential model were explored to derive a discontinuation rate from the Kaplan–Meier curve. Both models appear to overestimate discontinuation. Roche assumed that the steep rate of discontinuation in the first 2 years reflects the 'non-responders', whereas the flat rate after 2.5 years reflects the 'good responders'. Roche fitted an exponential distribution to the Kaplan–Meier curve after the first 2.5 years and used that as the probability of discontinuation from treatment for patients with initial response: annual rate of 0.098 ( $R^2 = 0.99$ ), 6-month probability of 0.05. The figure provided by Roche illustrating the fits is reproduced in *Figure 77*.

---

**FIGURE 75** Conditional inference tree of first-line treatment cessation, showing patterns of treatment cessation within the economic model, (left to right) shortest to longest times presented by Pfizer. (AiC information has been removed.)

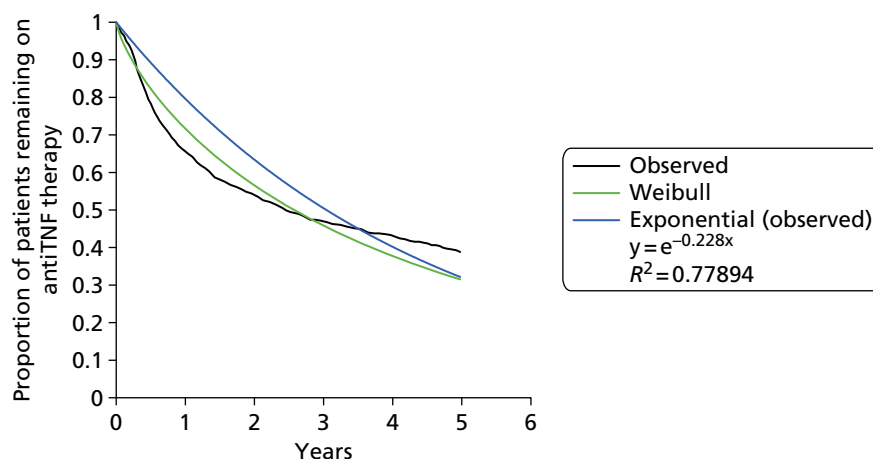
---

**FIGURE 76** Treatment cessation in second and subsequent lines estimated by Pfizer. (AiC information has been removed.)

**TABLE 121** Log-logistic survival models for all-cause treatment cessation as estimated by Pfizer

CiC information has been removed				
CiC information has been removed	CiC information has been removed	CiC information has been removed	CiC information has been removed	CiC information has been removed
CiC information has been removed	CiC information has been removed	CiC information has been removed	CiC information has been removed	CiC information has been removed
CiC information has been removed	CiC information has been removed	CiC information has been removed	CiC information has been removed	CiC information has been removed
CiC information has been removed	CiC information has been removed	CiC information has been removed	CiC information has been removed	CiC information has been removed
CiC information has been removed				
CiC information has been removed	CiC information has been removed	CiC information has been removed	CiC information has been removed	CiC information has been removed
CiC information has been removed	CiC information has been removed	CiC information has been removed	CiC information has been removed	CiC information has been removed
CiC information has been removed	CiC information has been removed	CiC information has been removed	CiC information has been removed	CiC information has been removed
CiC information has been removed				
CiC information has been removed	CiC information has been removed	CiC information has been removed	CiC information has been removed	CiC information has been removed
CiC information has been removed	CiC information has been removed	CiC information has been removed	CiC information has been removed	CiC information has been removed
CiC information has been removed	CiC information has been removed	CiC information has been removed	CiC information has been removed	CiC information has been removed
CiC information has been removed	CiC information has been removed	CiC information has been removed	CiC information has been removed	CiC information has been removed
Relative treatment effects from log-logistic survival model (vs. ETN) <sup>a</sup>				
<i>Parameter</i>	<i>Coefficient</i>			
ADA vs. ETN	-0.412 <sup>b</sup>			
IFX vs. ETN	-0.905			
Relative treatment effects from log-logistic survival model (vs. ETN)				
<i>Parameter</i>	<i>Coefficient</i>			
Subsequent lines vs. first-line use	-0.365			
a Unless specified, the relative treatment effect was assumed to be 0.000.				
b Also used for CTZ and GOL.				





**FIGURE 77** The Weibull and exponential model fitted by Roche to data from Soliman *et al.*<sup>249</sup>

An adjustment to these curves is based on data from Anderson *et al.*,<sup>259</sup> a study that explores predicting factors of response to treatment in RA. The study suggests that disease duration is one of the most important factors predicting response. Anderson analysed data from randomised control trials of drugs or devices in RA and found that the disease duration effect on odds of response was 0.98 per extra year of disease duration. This is not included in the base case but has been tested in the sensitivity analysis.

### UCB Pharma

UCB Pharma presents data on the risk of treatment discontinuation due to AEs explicitly and due to all causes. The discontinuation due to AEs was denoted AiC.

(Academic-in-confidence information has been removed.)

For all discontinuations the time spent on treatment was based on values from a study including over 2300 patients treated with a TNF- $\alpha$  inhibitor over 9 years.<sup>251</sup> Results from this study showed that the median time on treatment with a TNF- $\alpha$  inhibitor was 37 months (3.08 years). The same treatment duration was assumed for all biologics.

### Rebound post treatment

#### All interventions

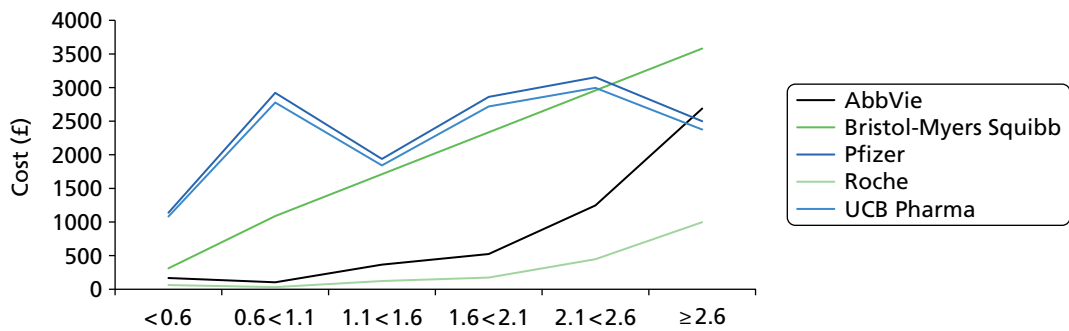
Following the cessation of treatment a patient's HAQ score is updated to reflect the loss of HAQ improvement on the previous line of therapy. MSD, Pfizer, Roche and UCB Pharma conduct sensitivity analyses around this assumption. UCB Pharma assumes that the loss of efficacy from the previous treatment and the gain in efficacy from the subsequent treatment happen simultaneously.

#### Assumed NHS costs per Health Assessment Questionnaire band

The hospital costs assumed to be associated with HAQ score in each model are reported in this section. In summary, a number of different sources are used (the data have been graphed in *Figure 78*). The data from MSD have been omitted as these are based on a more complex formula incorporating factors such as age, disease duration and previous number of DMARDs and cannot be easily summarised. Pfizer and UCB Pharma purport to use the same source and the reason for the slight discrepancy is unclear.

### AbbVie

AbbVie reports that patients with more severe symptoms of joint disease are more likely to be hospitalised and may require surgical procedures such as joint replacement. Disease-related hospital costs were estimated based on the Norfolk Arthritis Register (NOAR) database<sup>260</sup> and multiplied by NHS reference costs.<sup>261</sup> The resource use for HAQ costs assumed by AbbVie are given in *Table 122*.



**FIGURE 78** A summation of the hospital costs (annual) assumed associated with each HAQ band.

**TABLE 122** The hospital costs by HAQ band assumed by AbbVie

HAQ band	Total cost (£)
0.0 to <0.5	167.41
0.5 to <1.0	102.54
1.0 to <1.5	364.68
1.5 to <2.0	523.68
2.0 to <2.5	1246.26
2.5 to <3.0	2687.97

### Bristol-Myers Squibb

Bristol-Myers Squibb assumes a cost per unit HAQ score, to incorporate costs for hospitalisation and joint replacement based on Malotki *et al.*<sup>171</sup> This was inflated to £1245 per HAQ unit score to reflect 2011/12 prices.<sup>232</sup>

### Merck Sharp & Dohme Corp.

Data from Brennan *et al.*<sup>183</sup> were used to estimate the number of hospitalisations within the UK for every cycle of the model dependent on a number of characteristics, including TNF- $\alpha$  inhibitor treatment, which is used as a proxy for bDMARD treatment. The coefficients reported in Brennan *et al.*<sup>183</sup> are reproduced in *Table 123*. Costs of an inpatient day were estimated from NHS reference costs 2010–11 (non-elective inpatient PA34B) with a mean of £517.<sup>261</sup>

**TABLE 123** Multivariate regression used by MSD to estimate the number of days of hospital stay

Independent variable	Coefficient
Intercept	0.2351
Utility at baseline	-0.5467
Age (years)	0.0078
Disease duration	0.0075
Previous number of DMARDs	0.0648
AntiTNF	-0.062

Data are shown to the level of accuracy available in the source material.

## Pfizer

Direct annual costs of medical resource use, stratified by HAQ score, were uplifted<sup>232</sup> to 2011/12 prices from estimates provided by Kobelt *et al.*<sup>262</sup> derived from a UK observational database [the Early Rheumatoid Arthritis Study (ERAS)<sup>263</sup>]. Pfizer considered these data to be the most appropriate because it involved a multifaceted approach from the perspective of the NHS. Approaches to estimating costs in other identified sources were more restrictive in the items included. For example, Brennan *et al.*<sup>183</sup> included only inpatient and monitoring costs. The costs assumed by Pfizer are provided in *Table 124*.

These costs encompassed a broad range of resource use including hospitalisations, surgical interventions, outpatient visits, medication and drug monitoring. The analysis did not include the costs of lost productivity, which have been used previously,<sup>228</sup> which do not meet the NICE reference case.<sup>225</sup> Alternative cost scenarios were considered in scenario analysis, including those used by Malotki *et al.*<sup>171</sup>

## Roche

It is assumed that patients often require inpatient care associated with RA in addition to the NHS resources utilised for drug administration and routine patient monitoring. Inpatient costs were calculated using the NOAR database. Inpatient hospitalisation was grouped by six HAQ score bands and is shown in *Table 125*.

The method to incorporate resource utilisation in this analysis follows Kobelt *et al.*<sup>264,265</sup>

**TABLE 124** The assumed annual costs of RA associated with HAQ score assumed by Pfizer

AiC information has been removed	AiC information has been removed
AiC information has been removed	AiC information has been removed
AiC information has been removed	AiC information has been removed
AiC information has been removed	AiC information has been removed
AiC information has been removed	AiC information has been removed
AiC information has been removed	AiC information has been removed
AiC information has been removed	AiC information has been removed

**TABLE 125** The inpatients visit by HAQ score assumed by Roche

HAQ band at registration	Patients in band, <i>n</i>	Patients with inpatient stay		Number of days in hospital in the following 12 months			
		<i>n</i>	%	Mean	Median	IQR	Range
0.0 < HAQ score < 0.5	326	7	0.02	0.26	0	0–0	0–26
0.6 < HAQ score < 1.0	800	16	0.02	0.13	0	0–0	0–21
1.1 < HAQ score < 1.5	386	11	0.03	0.51	0	0–0	0–83
1.6 < HAQ score < 2.0	229	12	0.05	0.72	0	0–0	0–25
2.1 < HAQ score < 2.6	127	25	0.13	1.86	0	0–0	0–48
2.6 < HAQ score < 3.0	148	31	0.21	4.16	0	0–0	0–50

IQR, interquartile range.

Each HAQ score category was assigned an inpatient cost of £240.00 per day which is multiplied with the utilisation factor corresponding to each HAQ score category. The resulting inpatient resource utilisation values used in the analysis is summarised in *Table 126*. Note, the Assessment Group has altered a typographical error in the last column (which read £62.40) and has changed the term per cycle (which is 6 months in the Roche model) to annual costs.

### UCB Pharma

Additional costs by HAQ-DI category, used by UCB Pharma, were taken from a study by Kobelt *et al.*<sup>262</sup> In this study, a cohort of 916 patients in the UK were followed up for a mean of 7.8 years. Costs included the use of health-care resources (direct) and loss of work capacity (indirect). Regression analyses were performed according to patients' HAQ-DI categories. Values were stated to be converted to British pounds (£), although it is unclear why this was necessary given a UK cohort and inflated to a cost year of 2012.<sup>232</sup> The costs are applied at each cycle within the model, based on the HAQ score of each health state at each time point. Only direct costs were included in the base-case analysis, although the indirect costs were taken into account in a sensitivity analysis. The Assessment Group noted a slight discrepancy between the numbers reported by UCB Pharma and those used in the model. These are reported in *Table 127*.

### Utility related to the Health Assessment Questionnaire

This section details the utility values used in the models and a summary of the studies used in the submissions. *Figure 79* provides a graphical estimation of the relationship between HAQ and utility assumed in the manufacturers' models. Data from UCB Pharma are not shown, as UCB Pharma uses EQ-5D data collected in the trial for ACR and EULAR categories and base utility around response categories.

### AbbVie

The utility values used in the base-case analysis by AbbVie were calculated using an equation reported within a poster<sup>266</sup> that maps between HAQ and EQ-5D, according to the UK-specific EQ-5D tariff derived by Dolan.<sup>267</sup>

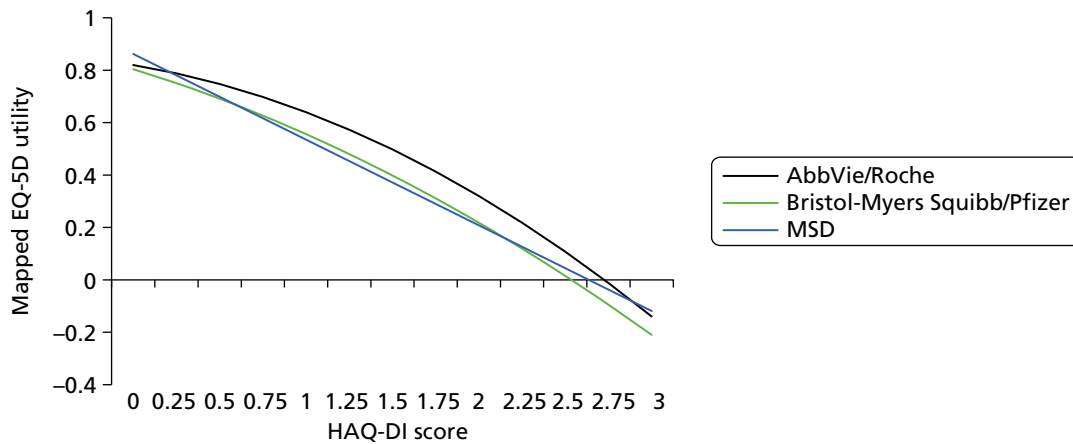
Both linear and non-linear equations for mapping HAQ to EQ-5D were presented. Using the linear utility mapping equation it is not possible for patients to achieve a negative utility, whereas the non-linear utility mapping equation relates a HAQ-DI score greater than approximately 2.7 to an EQ-5D score of < 0.

**TABLE 126** The inpatient costs assumed by HAQ score by Roche

HAQ scores	0<0.5	0.6<1	1.1<1.5	1.6<2.0	2.1<2.5	2.6<3.0
Inpatient cost per year (£)	62.40	31.20	122.40	172.80	446.40	998.40

**TABLE 127** Costs by HAQ-DI category

HAQ category	Direct costs (used in base case) (£)	Direct values used in the model (£)	Total costs including indirect costs (used in sensitivity analyses) (£)
< 0.6	1102	1082	1212
0.6–1.1	2827	2777	5000
1.1–1.6	1876	1842	4902
1.6–2.1	2769	2719	7388
2.1–2.6	3051	2996	10,105
≥ 2.6	2419	2376	9781



**FIGURE 79** The relationship between HAQ and utility assumed in the manufacturers' models.

Several studies examining quality of life in patients with RA indicate that severe RA health states can be associated with negative utility values, indicating that the non-linear mapping equation more accurately represents the relationship between HAQ and quality of life in patients with very severe RA and functional impairment.<sup>268-271</sup> This is supported by Ducournau *et al.*,<sup>266</sup> who report that the inclusion of a non-linear term resulted in an improved fit, and that the non-linear term was a significant coefficient. Previous analyses have also suggested a non-linear relationship between HAQ-DI and utility in RA patients.<sup>272</sup>

The main report provides no details whatsoever on issues required to judge the appropriateness or otherwise of the statistical models. No details of how uncertainty in the estimates was propagated in the model, if at all, are provided. No details are provided either on the data used to estimate the relationship, or the performance of the models in that data set. The appendix reports an additional model from the same data set that also includes age as a covariate, though the coefficient is quite small. No details are given as to why this was not used.

The provided poster of the Ducournau *et al.* reference<sup>266</sup> gives little additional detail. The overall numbers of patients reported in the trials are reported but no details on the numbers of observations used in the statistical analyses are provided.

The quadratic mapping equation was therefore selected for the base-case analysis whereas the linear mapping equation was examined in sensitivity analyses.

The model used to calculate utility values in the base-case analysis is:

$$\text{EQ-5D} = 0.804 - 0.203 \times \text{HAQ} - 0.045 \times \text{HAQ}^2. \quad (18)$$

In order to investigate the impact of the quadratic term on the results of the cost-effectiveness analysis, a sensitivity analysis was conducted using the linear regression model reported by Ducournau *et al.*<sup>266</sup>

The linear regression model used in the sensitivity analysis was:

$$\text{EQ-5D} = 0.89 - 0.28 \times \text{HAQ-DI}. \quad (19)$$

### Bristol-Myers Squibb

The HAQ score is converted into a utility value using the mapping algorithm used by Malottki *et al.*<sup>171</sup> (see *Equation 18*).

The report does not state whether or not the parameter uncertainty in this regression was taken into account (e.g. by using the variances/covariances) or if the error terms were also included in order to reflect the additional heterogeneity in the patient-level sample. Bristol-Myers Squibb consider a sensitivity analysis that uses an alternative linear regression from Malottki *et al.*,<sup>171</sup> which excludes the quadratic term.

Malottki *et al.*<sup>171</sup> report this regression as 'Birmingham analysis of data set from Hurst'.<sup>241</sup> Only CIs on the coefficients are reported, not the covariances. Hurst *et al.*<sup>241</sup> is a study from 1997 of 233 RA patients. Note that in their regression work they also find that both pain and HAQ score are significant predictors of EQ-5D. No detail of model fit is provided.

### Merck Sharp & Dohme Corp.

The quality-of-life equations used in the MSD submission are provided in *Table 128* with reference to Chen *et al.*<sup>123</sup> It is not clear if the uncertainty, and covariance in the estimated coefficients, was considered in sensitivity analysis.

### Pfizer

The primary analysis in all populations used the algorithm derived by Malottki *et al.*<sup>171</sup> (see *Equation 18*).

Pfizer undertook a systematic review of mapping studies in RA (section 2.3.3.2.2). Many studies were discarded because the studies were conducted using patients from a non-UK patient population.

The Assessment Group comment that there is no requirement in the NICE methods guide (either version 2008<sup>273</sup> or 2013<sup>274</sup>) for patients to be selected from the UK, nor is there any obvious theoretical reason why this should be the case. The guide requires that the valuations of health states described by these patients are drawn from the UK, and in RA this would be appropriately achieved by using the UK tariff of the EQ-5D instrument.

The use of this criterion in their selection of studies is therefore misguided.

Three studies remain in Pfizer's table 50: Hurst *et al.*<sup>241</sup> (and the subsequent fitting of a quadratic equation to the same data in Malottki *et al.*<sup>171</sup>), Bansback *et al.*<sup>275</sup> and Hernandez-Alava *et al.*<sup>276</sup> The submission uses the Malottki *et al.*<sup>171</sup> equation as the base case and the original Hurst *et al.*<sup>241</sup> regression in scenario analysis. Pfizer's table 50 provides their rationale for discarding the Bansback *et al.*<sup>275</sup> and Hernandez-Alava *et al.*<sup>276</sup> studies. Further details are given for each of these studies below but some key points require addressing here:

**TABLE 128** The quality-of-life equations used in the MSD submission

Parameter	Regression estimate	SE
Constant	0.862	0.034
Coefficient for HAQ score	-0.327	0.0201

Data are shown to the level of accuracy available in the source material.

The reporting of the characteristics of these three studies is misleading:

- Bansback *et al.*<sup>275</sup> is discarded on the basis that it includes both UK and Canadian patients. However, it is clearly stated that the UK tariff is applied to the EQ-5D analysis and therefore the criticism is misguided.
- Hurst *et al.*<sup>241</sup> is claimed to have 'Relevant summary statistics reported' whereas Hernandez-Alava *et al.*<sup>276</sup> is 'The sample of the statistical analysis is not clearly stated'. In fact, the sample of patients is fully described in the accompanying clinical trial paper referred to in the manuscript. Critical to the selection of an appropriate statistical model is the distributional characteristics of the dependent variable – this is not reported in Hurst *et al.*<sup>241</sup>
- Doubt is cast on the Hernandez-Alava *et al.*<sup>276</sup> results as the patients are defined as having early RA at baseline which may not be generalisable to more established disease. However, Hurst *et al.*<sup>241</sup> comprises a mixed population of both early- and late-stage disease, there is a clear relationship between patient degree of functional severity and disease duration (table I), but there is no statistically significant relationship between duration and EQ-5D (table V) and nor does it feature in any of the regression analyses (though the study may be too small to detect any effect). It is therefore difficult to see how the same criticism of the relevance of the Hernandez-Alava *et al.*<sup>276</sup> paper to the current decision problem does not also apply to the Hurst *et al.*<sup>241</sup> analysis.
- The most important issue is stated as VAS pain is not estimated over time, therefore not supporting the current model approach. For clarity, the Hernandez-Alava *et al.*<sup>276</sup> work did include pain score as a separate covariate alongside HAQ because a much more powerful model results (this was also found by Hurst *et al.*<sup>241</sup>). It is the Pfizer cost-effectiveness model that does not consider pain and therefore was considered incapable of using the results, though, of course, a HAQ based model could be adapted to also include the assessment of pain.

## Roche

The method to assign utility weights to simulated patients and to derive QALY outcomes in the model is the same as used in our TCZ and MTX combination therapy NICE submission.<sup>231</sup> The analysis uses a mechanism of mapping utility from patient HAQ score. This technique is also similar to previously published cost-utility studies and reimbursement submissions of biologic treatments in RA.<sup>178,182</sup> A description of the methods is presented in the appendix.

The base-case analysis uses a quadratic equation to map HAQ to utility:

$$\text{EQ-5D} = 0.82 - 0.11 \times \text{HAQ} - 0.07 \times \text{HAQ}^2 \quad (p\text{-value} < 0.0001; \text{ for both coefficients}). \quad (20)$$

The estimates come from two Phase III trials [tOcilimumab Pivotal Trial In methotrexate inadequate respONders (OPTION)<sup>132</sup> and tocilizumab safety and the prevention of structural joint damage methotrexate and sulfasalazine combination trial (LITHE)<sup>130</sup>]. The numbers within the analyses are not reported, nor is any information on the distribution of the data. Only *p*-values are given for the estimated coefficients: no SEs or CIs. There is no information that allows one to judge the fit of the model to the actual data. Roche compared HAQ and HAQ<sup>2</sup> models, and one with age (not age<sup>2</sup>). Roche found that the age coefficient was very small (surprisingly and not consistent with most other findings that EQ-5D is strongly related to age) so dropped these analyses.

The model with HAQ<sup>2</sup> is selected because it has a better fit, but this is not assessed using any kind of penalised likelihood test. In fact, their chi-squared test is equivalent to the *p*-value on the HAQ<sup>2</sup> coefficient and not appropriate for comparing models. This is important because adding an additional covariate will improve fit, but it is not good practice to simply improve fit by adding covariates: this risks losing generalisability.

In the sensitivity analysis three alternatives are tested, though it is not reported where they have come from, except the last which is based on Hernandez-Alava *et al.*<sup>276</sup> however, the uncertainty in the coefficients was not used.

### UCB Pharma

UCB Pharma has a different model structure from the others in that they are basing it predominantly around response categories within a Markov framework.

This is done in several steps.

Critically, in the severe disease population:

1. Initial response is defined in terms of ACR category and a mean EQ-5D improvement estimated from a linear regression using trial data from the RAPID RCTs.<sup>135,136</sup> No information on key statistics such as model fit or the data sample was provided, making it impossible to judge appropriateness or otherwise. It was unclear how probabilistic sensitivity analysis (PSA) implemented nor how additional covariates were selected or used.
2. Continued improvement in HAQ is converted to EQ-5D score from Bansback *et al.*<sup>277</sup>

In the moderate disease population:

1. Initial response is defined in terms of EULAR category. Regression analysis is used to estimate EQ-5D change by EULAR category based on data from the CERTAIN study.<sup>79</sup> No details are given. Different estimates are made according to the treatment strategy (i.e. this is not assumed to be a relationship that is independent of treatment).
2. The same Bansback *et al.*<sup>277</sup> estimate is then used for other elements of the model.

### Summary of studies used in submissions

Hurst *et al.*<sup>241</sup> and Malottki *et al.*<sup>171</sup> are used as the base case by Bristol-Myers Squibb, MSD and Pfizer, and used in sensitivity analysis by TCZ.

Hurst *et al.*<sup>241</sup> recruited 233 patients with RA from Scottish RA outpatient departments. They also aimed to recruit more severe patients from inpatients and via GPs and residential care. They failed to recruit the desired numbers of patients into functional severity class 4. The paper reports 3-month follow-up data and compares them with baseline data. There is no combined analysis.

The paper does not display the distribution of HAQ or EQ-5D tariff score.

Linear regression was used to estimate EQ-5D as a function of HAQ and other covariates, with stepwise regression used to select variables.

The reported model for EQ-5D at 3 months includes HAQ, HAQ mood score, pain VAS, disease activity and ESR.

The simple linear model that uses only HAQ as an explanatory variable is not reported in the Hurst *et al.*<sup>241</sup> paper but is reported in Chen *et al.*<sup>123</sup> who were supplied with the Hurst *et al.*<sup>241</sup> data set. They report no details about the sample used (whether or not this was identical to that reported in the paper), its spread, how repeated observations were dealt with, the distribution of the explanatory variable and its range, how the model performed in terms of fit, bias, predictions outside the feasible range. No details of the uncertainty in the estimated coefficients are provided by Chen *et al.*<sup>123</sup> Malottki *et al.*<sup>171</sup> is an update from the same group and they similarly report no details on any relevant information required to make a judgement as to the appropriateness or otherwise of the statistical model. The only change made is the addition of a quadratic term.



### The assumed costs and disutilities associated with adverse events

The assumptions regarding AEs within each submission are detailed in this section. In summary, only two of the six manufacturers explicitly included the costs of serious AEs within the submission. These were AbbVie (£4568 per episode) and Pfizer (£1497 per episode), with Pfizer only examining this within a sensitivity analysis.

Only Pfizer included disutility associated with a serious AE, assuming a disutility of 0.156 for a period of 28 days, equating to approximately a 0.012 QALY loss.

Data on the rates of AEs are summarised in *Time to discontinuation of treatment*.

### AbbVie

AbbVie takes into account serious infections within its model, citing the important consequences arising in terms of resource utilisation following serious infection. It was assumed that mild or moderate AEs had minimal impact on a patient's quality of life and have minimal cost implications. The baseline annual risk of serious infections under treatment with non-bDMARDs was extracted from a prospective observational study using BSRBR<sup>278</sup> data and assumed to be the same for all non-bDMARDs.

Baseline values for cDMARDs were extracted from BSRBR data, the risk of serious infections for biologic treatments being adjusted through risk parameters derived from a meta-analysis of safety parameters from clinical studies of biologics used in majority in RA.

Risk of serious infections under treatment with biologics was derived using odds ratios of serious infections of biologics versus control treatment derived from a systematic review and meta-analysis of 160 randomised clinical trials by the Cochrane collaboration (erroneously referenced as Hetland *et al.*<sup>250</sup>). Although the meta-analysis includes trials of biologics in indications other than RA (but excluding human immunodeficiency virus), the majority of trials have been conducted in RA, and AEs are considered to happen irrespective of indication.

To calculate the risks of serious infections under treatment of biologics, the baseline risk for DMARDs was converted to odds, the odds for each respective biologic were calculated using the odds ratios, which were subsequently converted to risks. Serious infection risks employed in the base-case analyses as well as odds ratios employed to estimate these are displayed in *Table 129*. The Assessment Group comment that the odds ratios shown in *Table 129* do not match *Figure 4* in the most recent version of Singh *et al.*<sup>165</sup>

**TABLE 129** The risk of serious infections assumed in the AbbVie model

Treatment	Risk	Odds ratio <sup>a</sup>
DMARDs (MTX, MTX + HCQ, SSZ + HCQ, LEF, SSZ, CYC, HCQ)	0.031493 <sup>b</sup>	Reference treatment
ABA (± MTX)	0.018198	0.57
ADA (± MTX)	0.035140	1.12
ETA (± MTX)	0.033320	1.08
INF (± MTX)	0.045027	3.51
RTX (± MTX)	0.030578	1.06
GOL (± MTX)	0.040259	1.29
TCZ (± MTX)	0.048867	1.45
CTZ (± MTX)	0.102444	0.97

a Singh *et al.*<sup>165</sup>

b Galloway *et al.*<sup>278</sup>

A sensitivity analysis was conducted setting the risk of AEs for ETN, ADA and IFX to 0.03767, 0.04075 and 0.04075, respectively (higher), based on the Galloway *et al.* BSRBR data.<sup>278</sup> Data are not available for other biologics from this BSRBR analysis.

The cost of serious infections was assumed to be equal to NHS reference cost HD23A (Inflammatory Spine, Joint or Connective Tissue Disorders, with Major CC) and was assumed to be £4568.38 per episode of care corresponding to the elective spell tariff of inflammatory spine, joint or connective tissue disorders with major complications. The mean length of stay corresponding to the elective spell tariff was 8.2 days, which was comparable with the median of 7 days suggested by Galloway *et al.*<sup>278</sup> used to derive baseline AE risks. Despite commenting on the effect on patients on serious infections no disutility associated with serious AEs were used.

### Bristol-Myers Squibb

The probabilities of AEs used within the Bristol-Myers Squibb model are shown in *Table 130*. The source for these data was not provided in the submission. AEs only result in discontinuation of present treatment. There are no cost implications, nor explicit utility implications.

### Merck Sharp & Dohme Corp.

Adverse events are incorporated into the model based on the proportion of patients who discontinue treatment due to AEs in the first 24 weeks (*Figure 80*).

Adverse events are assumed to be class related; therefore, the costs and utility outcomes are assumed to be equivalent between the bDMARDs. This rate does not appear to be tabulated in the submission. No costs or disutility associated with AEs are included in the MSD model, although MSD comments that it is possible that AE disutility associated with RA treatment was already incorporated into the mapping equation from HAQ to utility.

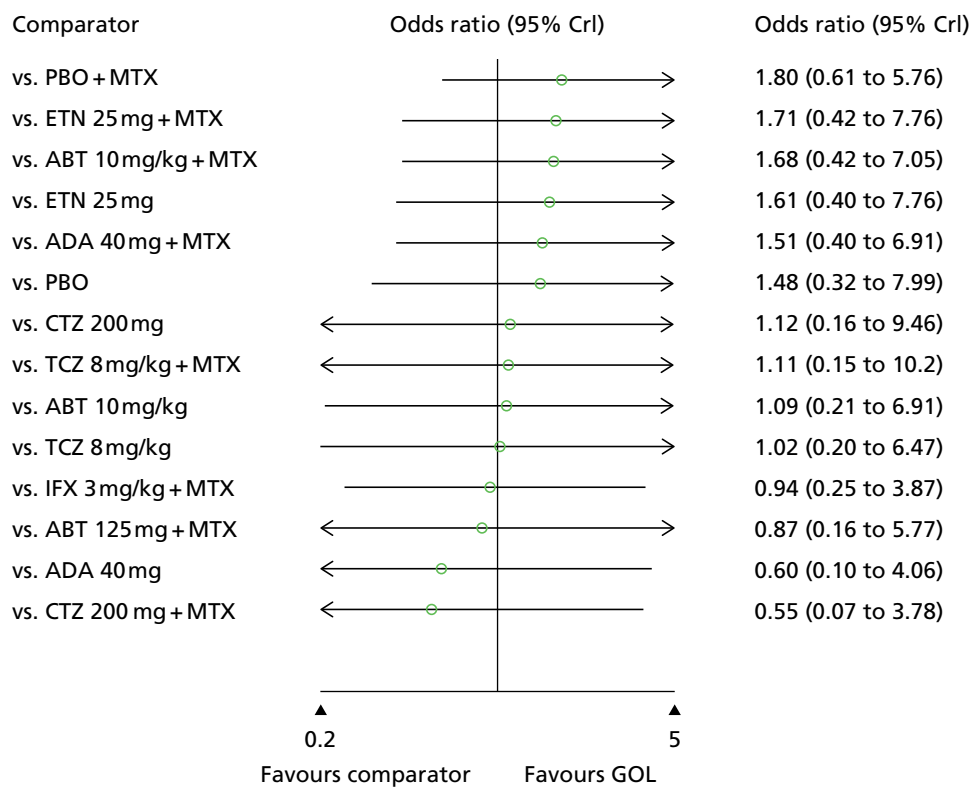
### Pfizer

Pfizer's base case did not model AEs, with the manufacturer noting that several manufacturers' submissions for NICE appraisals (for RA) have not modelled AEs.<sup>231,237,238</sup>

A scenario analysis including serious infections was performed. The medical resource use estimates derived from data presented by Kobelt *et al.*<sup>262</sup> contain costs of hospitalisations, and therefore AEs were not concluded within the primary analysis in order to avoid any 'double counting' of these costs.<sup>226</sup> Serious infections were selected for the model as opposed to, for example, serious AEs, as health-related quality of life consequences associated with infection in alternative populations have been well documented.<sup>279</sup> Following a serious infection, the Summary of Product Characteristics for all bDMARDs stipulates treatment

**TABLE 130** The assumed probability of AEs used in the Bristol-Myers Squibb models

Treatment	At month 6/week 24: probability of AE
ABT i.v.	0.023
ABT s.c.	0.016
ADA	0.041
ETN	0.030
IFX	0.086
TCZ	0.041
GOL	0.020
CTZ	0.096



**FIGURE 80** Odds ratio of discontinuations due to AEs in cDMARD-experienced patients assumed by MSD.

cessation, which is not the case for other serious AEs. Pfizer argues that the treatment of other AEs is unlikely to utilise a significant amount of medical resources or costs to the NHS.

Pfizer performed a NMA to estimate HRs of serious infection versus cDMARDs. These HRs were applied to the risk of serious infection for MTX,<sup>280</sup> estimated from NMA, to provide the cumulative probability of serious infection and are replicated in *Table 131*. GOL and IFX were assumed to have the same rate of serious infection as ADA as all have a similar mode of action. RTX was assumed to have the same rate of serious infection as TCZ as both are intravenously administered treatments.

### Cost of adverse events

Within the AEs scenario analysis, the cost of serious infection was assumed to be £1497 based on relevant NHS costs, weighted by inpatient activity.<sup>230</sup> Relevant Healthcare Resource Group codes were identified based on Lekander *et al.*<sup>194</sup> Conservatively, the without complications and contraindications Healthcare Resource Group costs were used. The costs of serious infection assumed by Pfizer in a sensitivity analysis are provided in *Table 132*.

Serious infections were assumed to persist for 28 days and confer a disutility of 0.156 during that time.<sup>279</sup>

### Roche

The economic model does not assume a difference in AEs between biologic treatments and assumes that neither associated costs nor utility decreases associated with AEs.

### UCB Pharma

The costs and outcomes associated with AEs were not included within the UCB Pharma model as it was assumed that all biologic therapies had similar safety profiles.

UCB Pharma comments on the robustness of Cochrane collaboration review of the AEs of biologics regarding the AEs of CTZ.<sup>281</sup> This comment is marked AiC.

**TABLE 131** Hazard ratio of serious infection vs. cDMARDs presented by Pfizer

	AiC information has been removed		
	AiC information has been removed	AiC information has been removed	AiC information has been removed
AiC information has been removed	AiC information has been removed	AiC information has been removed	AiC information has been removed
AiC information has been removed	AiC information has been removed	AiC information has been removed	AiC information has been removed
AiC information has been removed	AiC information has been removed	AiC information has been removed	AiC information has been removed
AiC information has been removed	AiC information has been removed	AiC information has been removed	AiC information has been removed
AiC information has been removed	AiC information has been removed	AiC information has been removed	AiC information has been removed
AiC information has been removed	AiC information has been removed	AiC information has been removed	AiC information has been removed
AiC information has been removed	AiC information has been removed	AiC information has been removed	AiC information has been removed
AiC information has been removed	AiC information has been removed	AiC information has been removed	AiC information has been removed
AiC information has been removed	AiC information has been removed	AiC information has been removed	AiC information has been removed
AiC information has been removed	AiC information has been removed	AiC information has been removed	AiC information has been removed
AiC information has been removed	AiC information has been removed	AiC information has been removed	AiC information has been removed
AiC information has been removed	AiC information has been removed	AiC information has been removed	AiC information has been removed
AiC information has been removed	AiC information has been removed	AiC information has been removed	AiC information has been removed
AiC information has been removed	AiC information has been removed	AiC information has been removed	AiC information has been removed

**TABLE 132** Costs of serious infection (using in scenario analysis only)

AiC information has been removed	AiC information has been removed	AiC information has been removed	AiC information has been removed
AiC information has been removed	AiC information has been removed	AiC information has been removed	AiC information has been removed
AiC information has been removed	AiC information has been removed	AiC information has been removed	AiC information has been removed
AiC information has been removed	AiC information has been removed	AiC information has been removed	AiC information has been removed
AiC information has been removed	AiC information has been removed	AiC information has been removed	AiC information has been removed
AiC information has been removed	AiC information has been removed	AiC information has been removed	AiC information has been removed
AiC information has been removed	AiC information has been removed	AiC information has been removed	AiC information has been removed
AiC information has been removed	AiC information has been removed	AiC information has been removed	AiC information has been removed
AiC information has been removed	AiC information has been removed	AiC information has been removed	AiC information has been removed

(Academic-in-confidence information has been removed.)

### **Mortality associated with rheumatoid arthritis**

The assumptions regarding the effect of RA (and HAQ score) on mortality are detailed for each submission.

In summary, there is no consensus of the most appropriate approach, although four submissions assume that the relative risk of mortality per HAQ score can be determined from a paper by Wolfe *et al.*<sup>282</sup>

These data (as will be detailed in the methodology used by the Assessment Group) are dated and have been superseded. Furthermore, these data do not indicate whether or not the mortality risk is reversible following treatment that reduces a patient's HAQ.

Two submissions have assumed standardised mortality rate for patients with RA that is assumed independent of HAQ. Pfizer has commented that the impact of mortality on cost-effectiveness ratios has been shown to be marginal owing to discounting.

### **AbbVie**

The submitted model includes general population mortality rates based on UK life tables. However, mortality rates are assumed to be affected by HAQ score. The effect of HAQ on mortality was expressed as a HR of 1.33 per unit increase in HAQ score for both males and females taken from Wolfe *et al.*<sup>282</sup> Sensitivity analysis varied the HR using values 1.00 and 1.88.

To implement this, general population mortality risks (2009) were derived by fitting a Gompertz function to the data from sex-specific UK life tables. The Gompertz function describes the exponential increase in mortality rates with increasing age in the absence of high rates of age-independent mortality.

$$S_i = e^{\left[\frac{(e^x - 1)e^x}{7}\right]}. \quad (21)$$

Table 133 provides the assumed Gompertz fit to standard mortality data.

**TABLE 133** The assumed Gompertz fit to standard mortality data within the AbbVie model

Sex	Mean	SE	Correlation
<b>Females</b>			
Lamda	-10.688847	0.05353145	-0.92256954
Gamma	0.0951409	0.00077774	
<b>Males</b>			
Lamda	-9.6568365	0.05960999	-0.92256954
Gamma	0.08567803	0.00086605	

The effect of HAQ on mortality was expressed as a HR of 1.33 per unit increase in HAQ score for males and females.<sup>19</sup> Two major assumptions are made:

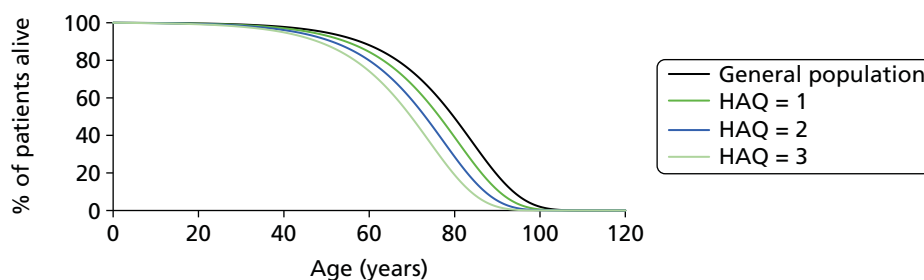
1. the HR was assumed to be linear in the HAQ
2. a change in the HAQ has an immediate effect on the expected mortality (i.e. not only the baseline HAQ).

AbbVie presents illustrative curves for mortality dependent on HAQ scores, which are reproduced in *Figures 81* and *82*.

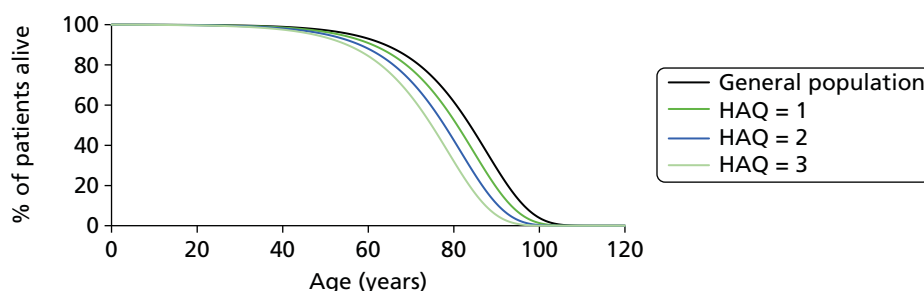
The Assessment Group comments that no goodness-of-fit values for the Gompertz model compared with the life table data were presented.

### Bristol-Myers Squibb

The expected age at which a patient dies is based on age, sex and HAQ score, and is recalculated every time the HAQ score changes. Once the age of the patient exceeds their assigned 'age at death', the patient dies. The age at death is calculated using conditional probabilities, as follows, replicating the methodology used by Barton *et al.*<sup>180</sup>



**FIGURE 81** An illustrative mortality survival curve presented by AbbVie for males.



**FIGURE 82** An illustrative mortality survival curve presented by AbbVie for females.

Let  $a$  and  $b$  be the sex-specific survival probabilities for ages  $x$  and  $y$ , respectively, for a member of the general population. The probability  $p$  that a patient of age  $x$  will survive to the age  $y$  is  $p = \frac{b}{a}$ .

However, it is assumed that there is an increased risk of death for patients with RA, modelled as a HAQ mortality ratio of 1.33 per unit HAQ.<sup>282</sup> Therefore, the probability  $p$  that a patient of age  $x$  will survive to the age  $y$  is  $p = \left(\frac{b}{a}\right)^{1.33 \times \text{HAQ}}$ . This can be rearranged to give  $b = a \times p^{\frac{1}{1.33 \times \text{HAQ}}}$ .

The model looks up the survival probability for the current age of the patient for  $a$  and uses a random number between 0 and 1 for  $p$ . The age at death is then calculated by looking up the age with the corresponding survival probability closest to  $b$ .

### Merck Sharp & Dohme Corp.

National life tables for the UK<sup>283</sup> were used to obtain age-dependent mortality rates. Furthermore, the proportions of males and females recruited in the IFX trials were used to estimate a weighted-average mortality risk by sex. The mortality rates taken from national life tables were annual rates. They were adjusted to the model cycle length rate using *Equation 22*:

$$r = -[\ln(1 - P)]/t. \quad (22)$$

The cycle rates were transformed into transition probabilities using *Equation 23*:

$$p = 1 - \exp\{-rt\}. \quad (23)$$

A standardised mortality ratio of 1.65 is used in the model, although not referenced in the report. This value is not HAQ dependent.

### Pfizer

Pfizer identifies a number of economic evaluations that have assumed either a general risk of mortality associated with RA that is independent of disease severity measures<sup>183,192,194,202,238,284,285</sup> or have expressed mortality as dependent on functional status (typically as expressed by HAQ).<sup>171,180,193,198,231,237,286,287</sup>

The Pfizer model adopts the former approach, assuming an age–sex-specific standardised mortality ratio from Brennan *et al.*,<sup>183</sup> who report age- and sex-specific standardised mortality ratios for a UK population.

This approach avoids the implicit assumption that mortality rates would differ between treatment sequences, but Pfizer reports that evidence suggests that this approach may be conservative.<sup>288,289</sup>

However, Pfizer also notes that assumptions on mortality have little impact on the cost-effectiveness ratios owing to discounting citing both NICE TA130<sup>207</sup> and Vera-Llonch *et al.*<sup>202</sup>

Pfizer comments that the original data used to estimate the function relating HAQ to mortality are now nearly 20 years old and from a non-UK population.<sup>282</sup> Therefore, the standardised mortality ratios used by Brennan *et al.*<sup>183</sup> were applied to life tables for England and Wales.<sup>283</sup> These values are replicated in *Table 134*.

**TABLE 134** The assumed standardised mortality ratios assumed by Pfizer

Age (years)	Male	Female
0–24	2.0	2.0
25–64	1.6	1.8
65–101	1.3	1.5

## Roche

The probability of death used within the Roche model is based on an adjusted life table provided by the Office for National Statistics.<sup>290</sup> A RA risk multiplier related to each simulated individual's HAQ score is applied at each cycle based on work by Wolfe *et al.*,<sup>282</sup> who studied the relationship between HAQ score and early mortality. Wolfe *et al.*<sup>282</sup> concluded that a relative risk of 1.33 (95% CI 1.099 to 1.610) was associated with each HAQ score point increase. The formula for converting this finding into an adjusted mortality risk (1.33 HAQ) was derived from Barton *et al.*<sup>180</sup>

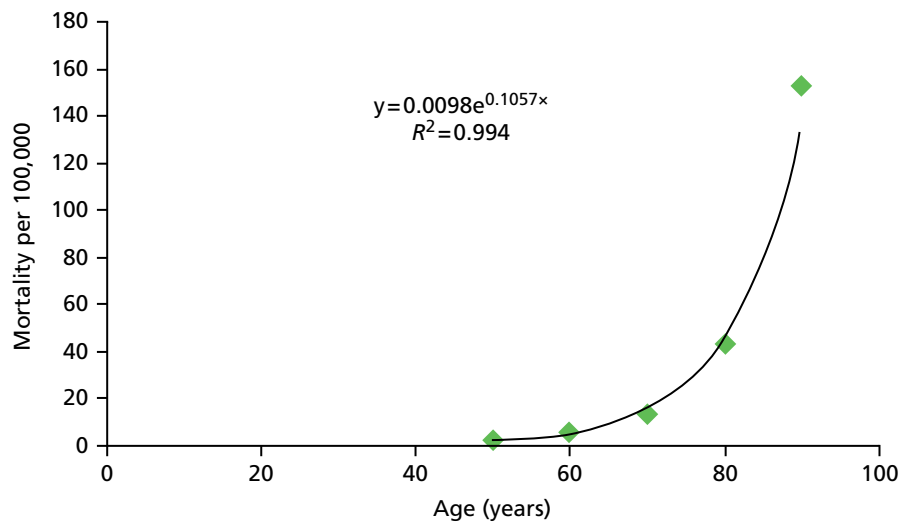
## UCB Pharma

The probability of all-cause mortality was derived from age- and sex-specific mortality rates for the general population from the Government Actuary Department, adjusted by HAQ-DI score. The base-case estimate of relative risk of death of 1.330 per HAQ-DI unit (95% CI 1.099 to 1.610) was taken from a 35-year cohort study of 3501 RA patients in Canada.<sup>282</sup> The starting mortality rate in cycle 1 was adjusted to the age and sex distribution of the model population and further adjustment was made in each model cycle to represent the increased risk of death as patients became older.

Examination of the UCB Pharma model suggests that an exponential distribution is fitted to the life table data and then a relative risk is applied. The exponential fits performed by the Assessment Group are shown in *Figure 83* for females and *Figure 84* for males. It is seen that the  $R^2$  value is in excess of 0.99.

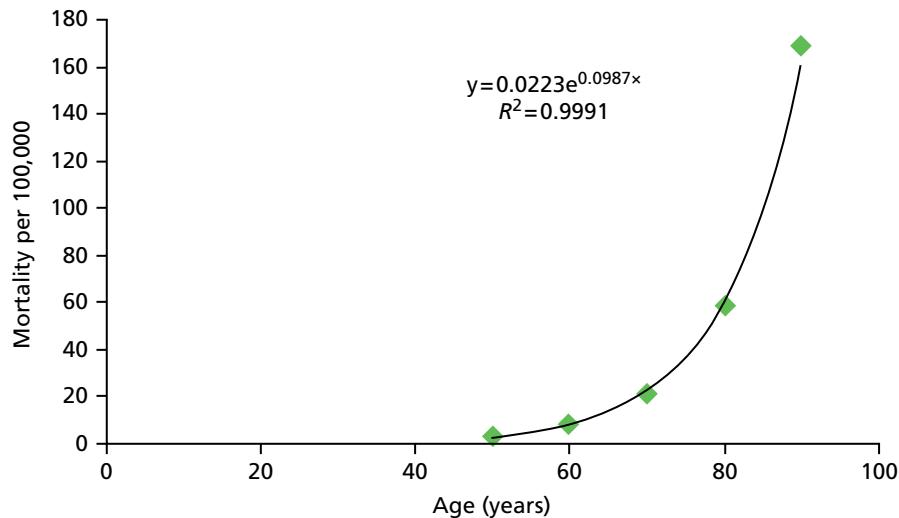
### Cost-effectiveness results within the manufacturers' submission

This section details the cost-effectiveness results reported by the manufacturers within their base cases for each of the analyses undertaken. Typically a large number of sensitivity analyses and descriptive features, such as cost-effectiveness acceptability curves (CEACs), cost-effectiveness planes and scatterplots are presented by the manufacturers. The Assessment Group has selected and reported the key information for brevity reasons, but has endeavoured to report the salient conclusions.



**FIGURE 83** The general mortality rate for females assumed by UCB Pharma, with an exponential fit to these data points. (AiC information has been removed.)





**FIGURE 84** The general mortality rate for males assumed by UCB Pharma, with an exponential fit to these data points. (AIC information has been removed.)

Within the section the following terminology has been used to aid understanding (analyses 1–6 represent the decision problems within the NICE scope):

- analysis 1: population 2 in combination with MTX
- analysis 2: population 3 in combination with MTX
- analysis 3: population 1 in combination with MTX
- analysis 4: population 2 monotherapy
- analysis 5: population 3 monotherapy
- analysis 6: population 1 monotherapy
- analysis 7: general RA population who can receive MTX
- analysis 8: MTX-intolerant or -contraindicated RA population.

*Table 135* provides a summary of each manufacturer's interpretation of the cost-effectiveness analyses for their product. Where a manufacturer did not undertake an analysis the cell is blank; otherwise the Assessment Group's conclusion of the manufacturers' interpretation of the cost-effectiveness is shown. Three manufacturers (AbbVie, Bristol-Myers Squibb and MSD) have stated that the bDMARDs have similar cost-effectiveness ratios and should be analysed jointly; Pfizer and UCB Pharma make preferential statements about their interventions, whereas Roche has conducted an analysis that consists only of adding TCZ as a monotherapy as first line before a non-NICE-recommended sequence. There are few clear patterns exhibited in *Table 135*, except that all manufacturers believe their product is cost-effective in analysis 1 and all bar UCB Pharma believe their interventions are cost-effective in analysis 2. It is commented that the analysis 1 undertaken by UCB Pharma omitted a comparison against a cDMARD-only strategy. Given that the remaining manufacturers often commented that the ICERs between populations 2 and 3 were similar, it is possible that UCB Pharma would have estimated bDMARDs not to be cost-effective in population 3 were the correct comparison to be made.

These results will be affected by the consideration (or not) of PASs, which are in place for ABT i.v., ABT s.c., CTZ, GOL and TCZ. AbbVie does not consider current PASs. None of MSD, Pfizer and UCB Pharma include PASs for TCZ or ABT as these are CiC. Bristol-Myers Squibb and Roche use PASs for all relevant drugs in their analyses.

Data have been reproduced from a manufacturer's submission. In some cases it was not possible to align the abbreviations used with those used by the Assessment Group.

**TABLE 135** A summary of each manufacturer's interpretation of the cost-effectiveness analyses for their product assuming a cost per QALY threshold of £30,000

Analysis	Decision problem	Scope	Manufacturer						
			AbbVie (ADA)	Bristol-Myers Squibb (ABT i.v.; ABT s.c.)	MSD (GOL)	MSD (IFX)	Pfizer (ETN)	Roche (TCZ)	UCB Pharma (CTZ)
1	Population 2 in combination with MTX	✓	CE (group)		CE (group)	CE (group)	Most CE		Most CE
2	Population 3 in combination with MTX	✓	CE (group)				CE (sole)		Not CE
3	Population 1 in combination with MTX	✓	Not CE				Not CE		
4	Population 2 monotherapy	✓	Not CE				Most CE		Most CE
5	Population 3 monotherapy	✓	Not CE						Not CE
6	Population 1 monotherapy	✓	Not CE						
7	General RA population who can tolerate MTX <sup>a</sup>			CE (group)		CE (group)	CE (group)		CE (sole)
8	MTX-intolerant or -contraindicated RA population <sup>b</sup>								

CE, cost-effective.

a In essence, analyses 1 and 2 combined.

b In essence, analyses 4 and 5 combined.

**Notes**

Shaded cells indicate the intervention is not licensed in this population; blank cells indicate an analyses was not conducted.

CE (group) denotes the manufacturer is stating that the bDMARDs have similar ICERs and that all are cost-effective compared with cDMARDs alone.

CE (sole) denotes the manufacturer did not consider other bDMARDs within the analyses.

Most CE denotes the manufacturer is stating that their intervention is the most cost-effective bDMARD and that it is cost-effective compared with cDMARDs alone.

Not CE denotes the manufacturer does not claim the intervention is cost-effective compared with cDMARDs.

## AbbVie

The Assessment Group notes that ABT s.c. has not been included in the AbbVie submission, that the responder criterion is ACR50 and that the PASs in place for some interventions have not been included.

Despite performing PSAs, AbbVie presents deterministic results in the base-case tables. The sequence numbers shown in the AbbVie results are aligned with those reported in AbbVie.

The incremental cost-effectiveness analyses are shown in *Table 136* for analysis 1 and *Table 137* for analysis 2. CEACs from the probabilistic analyses are provided in *Figure 85* for analysis 1 and *Figure 86* for analysis 2.

The incremental cost-effectiveness analyses for analysis 3 are shown in *Table 138* with the CEACs from the probabilistic analyses provided in *Figure 87*.

The incremental cost-effectiveness analyses are shown in *Table 139* for analysis 4 and *Table 140* for analysis 5. CEACs from the probabilistic analyses are provided in *Figure 88* for analysis 4 and *Figure 89* for analysis 5.

The incremental cost-effectiveness analyses for analysis 6 are shown in *Table 141* with the CEACs from the probabilistic analyses provided in *Figure 90*.

**TABLE 136** Incremental cost-effectiveness ratios for analysis 1 as reported by AbbVie

Sequence	Technology	Total		Incremental		ICER	
		Costs (£)	QALYs	Costs (£)	QALYs	vs. DMARDs (£)	Incremental (£)
1	cDMARDs	36,636	1.747				
8	TCZ + MTX	94,128	4.433	57,492	2.686	21,405	Extendedly dominated
4	IFX + MTX	97,366	4.981	60,731	3.234	18,781	Dominated
7	ABT + MTX	116,143	5.036	79,508	3.289	24,172	Dominated
6	GOL + MTX	95,754	5.107	59,118	3.360	17,594	Dominated
2	ADA + MTX	94,618	5.230	57,983	3.483	16,650	Extendedly dominated
5	CTZ + MTX	97,091	5.288	60,455	3.541	17,071	Dominated
3	ETN + MTX	96,785	5.377	60,149	3.630	16,571	16,571

**TABLE 137** Incremental cost-effectiveness ratios for analysis 2 as reported by AbbVie

Sequence	Technology	Total		Incremental		ICER	
		Costs (£)	QALYs	Costs (£)	QALYs	vs. DMARDs (£)	Incremental (£)
1	cDMARDs	36,521	3.510				
8	TCZ + MTX	99,402	6.128	62,882	2.619	24,014	Extendedly dominated
4	IFX + MTX	103,092	6.680	66,571	3.170	21,000	Dominated
7	ABT + MTX	123,455	6.735	86,935	3.226	26,952	Dominated
6	GOL + MTX	101,605	6.799	65,084	3.290	19,784	Dominated
2	ADA + MTX	100,495	6.914	63,974	3.404	18,792	Extendedly dominated
5	CTZ + MTX	103,093	6.974	66,572	3.464	19,217	Dominated
3	ETN + MTX	103,015	7.061	66,494	3.552	18,721	18,721

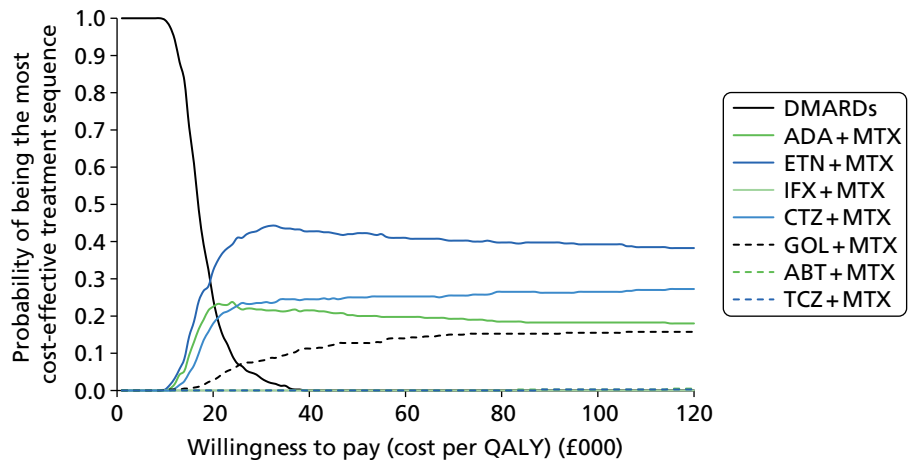


FIGURE 85 Cost-effectiveness acceptability curve for analysis 1 provided by AbbVie.

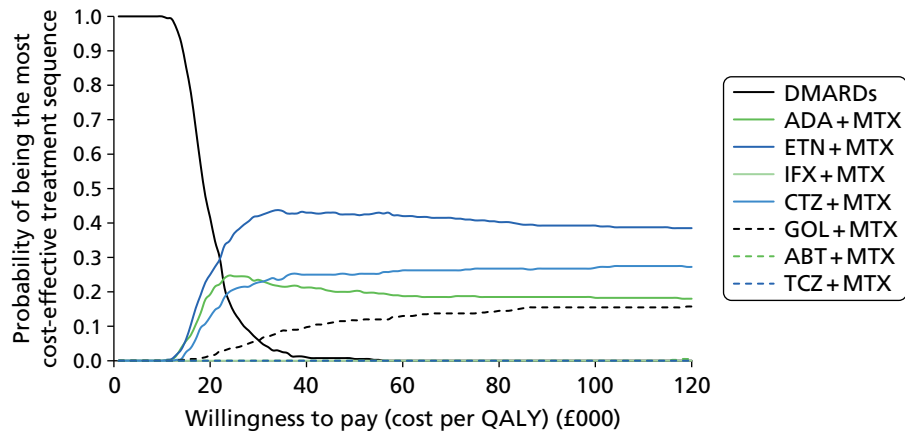
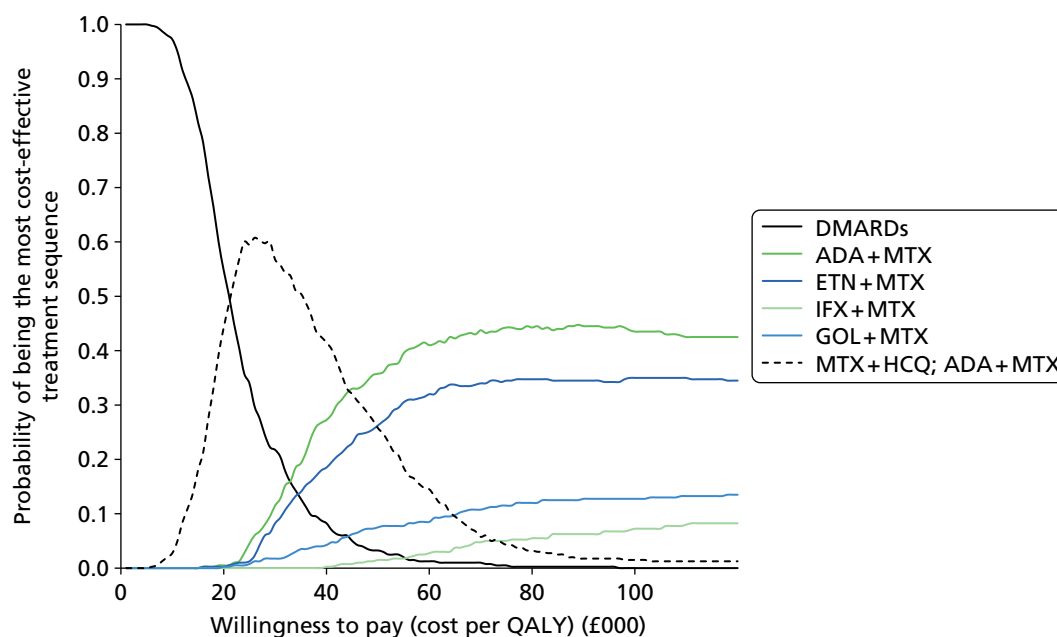


FIGURE 86 Cost-effectiveness acceptability curve for analysis 2 provided by AbbVie.

TABLE 138 Incremental cost-effectiveness ratios for analysis 3 as reported by AbbVie

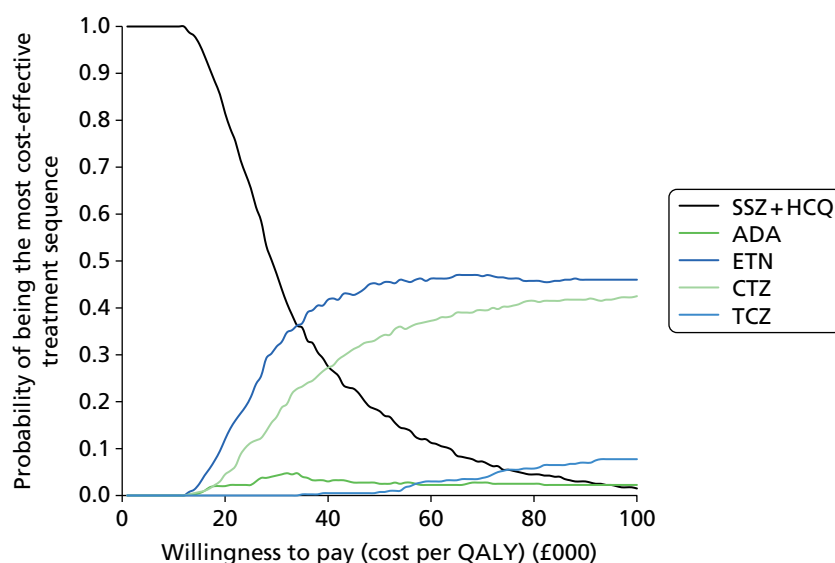
Sequence	Technology	Total		Incremental		ICER	
		Costs (£)	QALYs	Costs (£)	QALYs	vs. DMARDs (£)	Incremental (£)
1	MTX	27,076	5.104				
6	MTX + HCQ	64,908	7.162	37,832	2.058	18,381	18,381
5	GOL + MTX	107,556	7.539	80,479	2.436	33,044	Dominated
3	ETN + MTX	107,172	7.709	80,096	2.605	30,742	Dominated
4	IFX + MTX	113,598	7.721	86,522	2.618	33,055	Dominated
2	ADA + MTX	107,097	7.765	80,021	2.661	30,071	69,971



**FIGURE 87** Cost-effectiveness acceptability curve for analysis 3 provided by AbbVie.

**TABLE 139** Incremental cost-effectiveness ratios for analysis 4 as reported by AbbVie

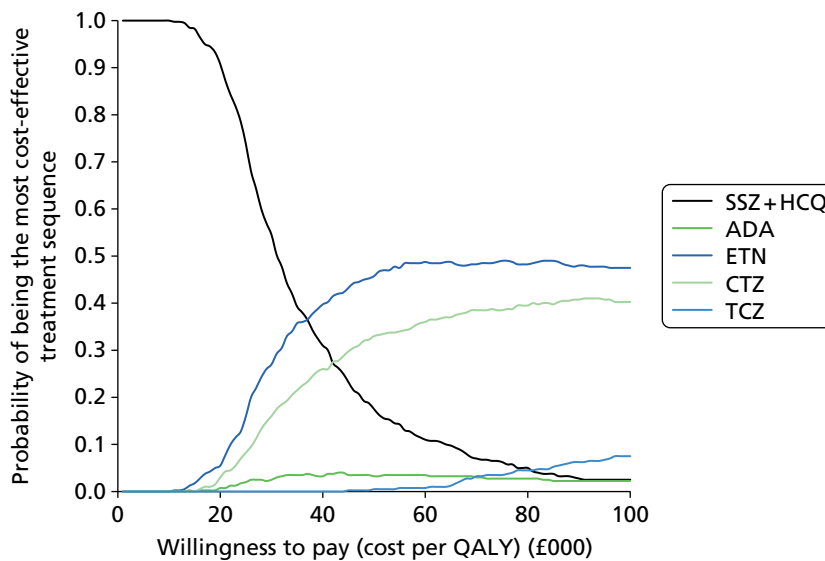
Sequence	Technology	Total		Incremental		ICER	
		Costs (£)	QALYs	Costs (£)	QALYs	vs. DMARDs (£)	Incremental (£)
1	cDMARDs	29,905	2.686				
2	ADA	51,019	3.278	21,114	0.592	35,641	Extendedly dominated
5	TCZ	75,098	3.573	45,193	0.887	50,972	Dominated
4	CTZ	57,245	3.579	27,341	0.893	30,609	Dominated
3	ETN	56,556	3.594	26,651	0.908	29,338	29,338



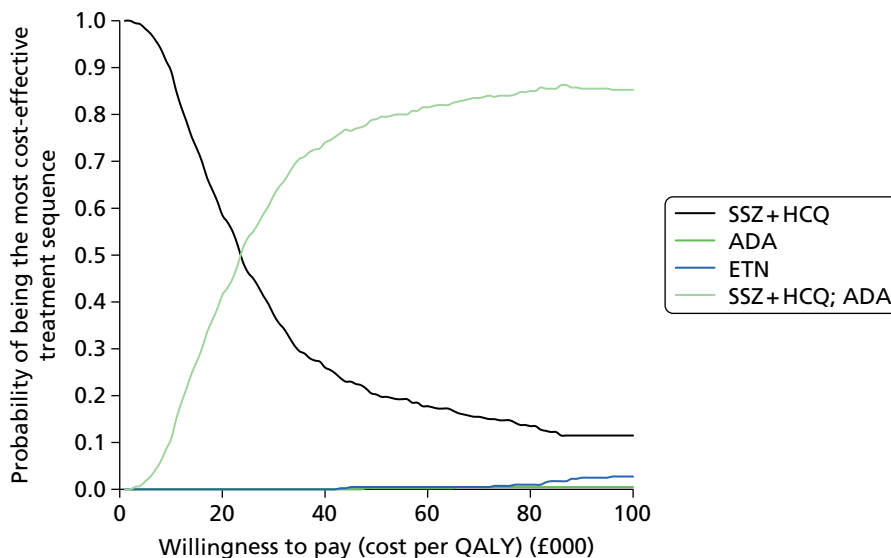
**FIGURE 88** Cost-effectiveness acceptability curve for analysis 4 provided by AbbVie.

**TABLE 140** Incremental cost-effectiveness ratios for analysis 5 as reported by AbbVie

Sequence	Technology	Total		Incremental		ICER	
		Costs (£)	QALYs	Costs (£)	QALYs	vs. DMARDs (£)	Incremental (£)
1	cDMARDs	30,113	4.319				
2	ADA	53,107	4.907	22,994	0.588	39,083	Extendedly dominated
5	TCZ	79,158	5.197	49,045	0.878	55,844	Dominated
4	CTZ	59,905	5.200	29,792	0.882	33,791	Dominated

**FIGURE 89** Cost-effectiveness acceptability curve for analysis 5 provided by AbbVie.**TABLE 141** Incremental cost-effectiveness ratios for analysis 6 as reported by AbbVie

Sequence	Technology	Total		Incremental		ICER	
		Costs (£)	QALYs	Costs (£)	QALYs	vs. DMARDs (£)	Incremental (£)
1	cDMARDs	29,629	5.122				
2	ADA	60,778	5.156	31,149	0.034	918,015	Dominated
3	ETN	63,859	5.293	34,230	0.170	201,097	Dominated
4	SSZ + HCQ (followed by ADA)	41,703	5.774	12,074	0.651	18,540	18,540



**FIGURE 90** Cost-effectiveness acceptability curve for analysis 6 provided by AbbVie.

### AbbVie's interpretation of its cost-effectiveness results

AbbVie states that:

*The main results from the cost-utility model are:*

- *In the MTX-experienced patient population with severe disease activity ( $DAS28 > 5.1$ ), ADA in combination with MTX is considered cost-effective, with a lifetime incremental cost per quality-adjusted life year (QALY) gained with respect to conventional DMARDs of £16,650. This is very similar to the estimated cost per QALY of ETN (£16,571) and certolizumab (£17,071), both taken in combination with MTX.*
- *In the MTX-experienced patient population with moderate disease activity ( $3.2 < DAS28 \leq 5.1$ ), ADA in combination with MTX is considered cost-effective, with a lifetime incremental cost per quality-adjusted life year (QALY) gained with respect to conventional DMARDs of £18,792. This is very similar to the estimated cost per QALY of ETN (£18,721) certolizumab (£19,217) and GOL (£19,784), all taken in combination with MTX.*

AbbVie concludes that its 'submission demonstrates that ADA in combination with MTX represents a clinical and cost-effective option for the treatment of RA patients with moderate and severe disease activity, for the NHS in the UK'.

### Bristol-Myers Squibb

The submission by Bristol-Myers Squibb evaluated the use of bDMARDs only in combination with MTX. The submission did not distinguish between patients with severe and moderate to severe RA, but evaluated these groups together. This did not meet the requirements of the scope and has been denoted as analysis 7.

Bristol-Myers Squibb presents the disaggregated incremental costs and QALYs for the deterministic scenario, but not for the probabilistic values where only the ICER (and CI around the ICER) are provided. The Assessment Group notes that the ICERs are lower for the probabilistic analyses than for the deterministic analyses.

The probabilistic ICERs detailed by Bristol-Myers Squibb are shown in *Table 142*. These data are marked CiC. *Figure 91* shows the CEAC generated by Bristol-Myers Squibb.

**TABLE 142** The probabilistic ICERs for analysis 7 provided by Bristol-Myers Squibb

Initial treatment	ICER vs. DMARDs		
	Mean	95% CI lower bound	95% CI upper bound
ABT i.v. + MTX	CiC information has been removed	CiC information has been removed	CiC information has been removed
ABT s.c. + MTX	CiC information has been removed	CiC information has been removed	CiC information has been removed
ADA + MTX	CiC information has been removed	CiC information has been removed	CiC information has been removed
ETN + MTX	CiC information has been removed	CiC information has been removed	CiC information has been removed
IFX + MTX	CiC information has been removed	CiC information has been removed	CiC information has been removed
TCZ + MTX	CiC information has been removed	CiC information has been removed	CiC information has been removed
GOL + MTX	CiC information has been removed	CiC information has been removed	CiC information has been removed
CTZ + MTX	CiC information has been removed	CiC information has been removed	CiC information has been removed

**FIGURE 91** Commercial-in-confidence information has been removed.***Bristol-Myers Squibb's interpretation of its cost-effectiveness results***

Bristol-Myers Squibb concludes that:

*... the results demonstrate that all of the biologics have similar ICERs when compared to DMARDs. The ICERs remain similar in scenario analyses (except when PASs are not considered). This, coupled with the overlap in the probabilistic sensitivity analysis demonstrates considerable uncertainty as to which treatment is the most cost-effective option.*

**Merck Sharp & Dohme Corp.**

The two submissions (one for GOL and one for IFX) from MSD will be detailed individually in terms of the cost-effectiveness results. It is commented that for both submissions only analyses 1 and 7 were undertaken. Analysis 7 does not meet the NICE scope as it combines RA patients with moderate to severe and severe disease.

The Assessment Group notes that MSD makes no comment on the discrepant absolute QALY values in the submission (in the region of 8 for the GOL submission and in the region of 6 for the IFX report).

***Golimumab***

The incremental analysis for analysis 1 within the GOL submission is reproduced in *Table 143*. Note that an additional column has been added to correctly calculate the incremental analysis.

The incremental analysis for analysis 7 within the GOL submission is reproduced in *Table 144*. Note that an additional column has been added to correctly calculate the incremental analysis. The CEAC for analysis 7 is shown in *Figure 92*.



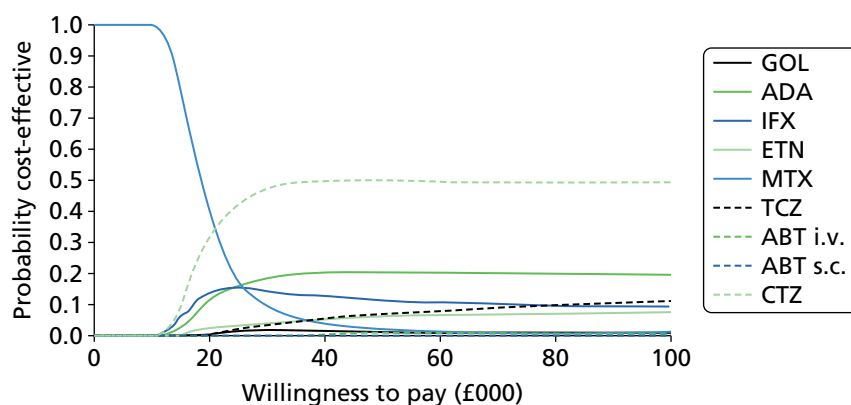
**TABLE 143** Incremental cost-effectiveness results (DMARD-experienced severe RA patient population subgroup) provided by MSD in the GOL submission

Technologies	Total costs (£)	Total QALYs	Incremental costs (£)	Incremental QALYs	ICER (£) vs. baseline (MTX)	MSD's incremental analysis (£)	Assessment Group's incremental analysis (£)
MTX	56,036	6.425	–	–	–	–	–
GOL + MTX	89,270	8.007	33,234	1.582	21,013	N/A	21,013

N/A, not applicable.

**TABLE 144** Incremental cost-effectiveness results (DMARD-experienced RA patient population) provided by MSD in the GOL submission

Technologies	Total costs (£)	Total QALYs	Incremental costs (£)	Incremental QALYs	ICER (£) vs. baseline (MTX)	MSD's incremental analysis (£)	Assessment Group's incremental analysis (£)
MTX	56,382	6.706	–	–	–	–	–
IFX + MTX	88,326	8.207	31,944	1.501	21,278	21,278	Extendedly dominated
ETN + MTX	91,025	8.068	2699	–0.139	25,429	Dominated	Dominated
GOL + MTX	92,130	8.307	1105	0.238	22,331	4631	Extendedly dominated
ADA + MTX	93,892	8.512	1762	0.205	20,769	8589	Extendedly dominated
CTZ + MTX	97,469	8.890	3577	0.377	18,817	9476	18,817
TCZ + MTX	100,702	8.495	3233	–0.395	24,774	Dominated	Dominated
ABT i.v. + MTX	105,102	8.100	4400	–0.395	34,953	Dominated	Dominated
ABT s.c. + MTX	118,036	8.100	12,934	0.000	44,232	Dominated	Dominated

**FIGURE 92** Cost-effectiveness acceptability curve for all bDMARDs for analysis 7 within the MSD GOL submission.

**Infliximab**

The incremental analysis for analysis 1 within the IFX submission is reproduced in *Table 145*. Note that an additional column has been added to correctly calculate the incremental analysis.

The incremental analysis for analysis 7 within the IFX submission is reproduced in *Table 146*. Note that an additional column has been added to correctly calculate the incremental analysis. The CEAC for analysis 7 is shown in *Figure 93*.

**Merck Sharp & Dohme Corp.'s interpretation of the cost-effectiveness results in both its golimumab and infliximab submissions**

Merck Sharp & Dohme Corp. states:

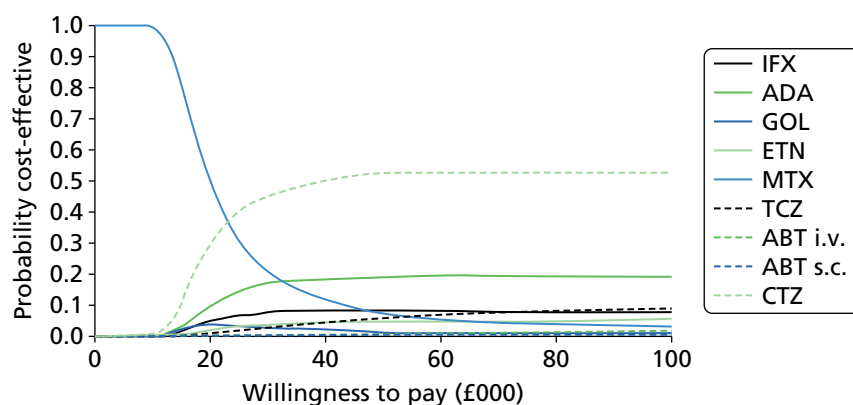
*These results indicate that golimumab/infliximab is a cost-effective treatment option for patients with moderate to severe RA who have had an inadequate response to conventional DMARDs. Due to differences in trial populations and design, using ICERs to 'rank' technologies should be approached with caution and we believe that the indirect comparison results indicate a class effect as no significant differences were identified between technologies. A casing [sic] point for this would be the placebo arm dropout in the certolizumab trials which would have acted to inflate the efficacy results for this technology.*

**TABLE 145** Incremental cost-effectiveness results (DMARD-experienced severe RA patient population subgroup) provided by MSD in the IFX submission

Technologies	Total costs (£)	Total QALYs	Incremental costs (£)	Incremental QALYs	ICER (£) vs. baseline (MTX)	MSD's incremental analysis (£)	Assessment Group's incremental analysis
MTX	58,181	4.504	–	–	–	–	–
IFX + MTX	84,007	5.539	25,827	1.034	24,968	N/A	24,968
N/A, not applicable.							

**TABLE 146** Incremental cost-effectiveness results (DMARD-experienced RA patient population) provided by MSD in the IFX submission

Technologies	Total costs (£)	Total QALYs	Incremental costs (£)	Incremental QALYs	ICER (£) vs. baseline (MTX)	Incremental analysis (£)	Assessment Group's incremental analysis
MTX	57,376	4.791	–	–	–	–	–
IFX + MTX	83,887	5.845	26,511	1.054	25,144	25,144	Extendedly dominated
ETN + MTX	84,947	5.678	1059	–0.167	31,065	Dominated	Dominated
GOL + MTX	87,027	5.909	2080	0.231	26,512	9010	Extendedly dominated
ADA + MTX	88,750	6.117	1723	0.207	23,663	8305	Extendedly dominated
CTZ + MTX	93,696	6.519	4946	0.403	21,011	12,281	21,011
TCZ + MTX	94,777	6.065	1080	–0.454	29,339	Dominated	Dominated
ABT i.v. + MTX	97,346	5.710	2570	–0.355	43,455	Dominated	Dominated
ABT s.c. + MTX	108,181	5.710	10,834	0.000	55,234	Dominated	Dominated



**FIGURE 93** Cost-effectiveness acceptability curve for all bDMARDs for analysis 7 within the MSD IFX submission.

Merck Sharp & Dohme Corp. additionally states that:

*Compared to other published studies in literature our DMARD experienced results indicate similar ICERs for TNF $\alpha$  inhibitors compared to palliation. Our model derives many assumptions from the Birmingham Rheumatoid Arthritis Model and thus the ICERs are in a similar range of those approved in recent NICE appraisals.*

It can be seen that the ICER for GOL/IFX in the severe only subgroup (DAS > 5.1) is similar to the ICER derived for the moderate–severe population and as such GOL/IFX can be considered cost-effective in both populations and should not be limited only to the treatment of patients with severe disease.’

## Pfizer

Pfizer sent an addendum to the Assessment Group after detecting minor errors within their mathematical model. These errors affected only scenarios where patients were ineligible for RTX plus MTX, which are not summarised in this section.

Pfizer undertook analyses 1–4. The results from these analyses are reproduced in *Tables 147–150*, with the CEACs reproduced in *Figures 94–97*.

**TABLE 147** Severe DMARD-inadequate responder combination therapy incremental analysis presented by Pfizer

Strategy	Costs (£)	QALYs	vs. cDMARD		vs. next less costly		ICER (£)
			Incremental costs (£)	Incremental QALYs	Incremental costs (£)	Incremental QALYs	
cDMARDs	111,612	2.638					
IFX + MTX	130,090	3.240	18,478	0.602	18,478	0.602	Extendedly dominated
ADA + MTX	133,121	3.395	21,509	0.756	3031	0.154	Extendedly dominated
CTZ + MTX	135,304	3.768	23,692	1.130	2183	0.374	Extendedly dominated
GOL + MTX	136,452	3.470	24,840	0.832	1148	−0.298	Dominated
ETN + MTX	140,686	4.055	29,074	1.417	4233	0.585	20,520
ABT i.v. + MTX	151,963	3.513	40,351	0.875	11,277	−0.542	Dominated
TCZ + MTX	153,442	3.704	41,830	1.066	1479	0.191	Dominated
ABT s.c. + MTX	162,064	3.530	50,452	0.891	8622	−0.174	Dominated

**TABLE 148** Moderate to severe population combination therapy incremental analysis presented by Pfizer

Strategy	Costs (£)	QALYs	vs. cDMARD		vs. next less costly		ICER (£)
			Incremental costs (£)	Incremental QALYs	Incremental costs (£)	Incremental QALYs	
cDMARD	128,305	8.493					
ETN + MTX	159,730	9.764	31,425	1.271	31,425	1.271	24,727

**TABLE 149** Severe naive population combination therapy incremental analysis presented by Pfizer

Strategy	Costs (£)	QALYs	vs. comb cDMARD		vs. next less costly		ICER (£)
			Incremental costs (£)	Incremental QALYs	Incremental costs (£)	Incremental QALYs	
cDMARD <sup>a</sup>	108,488	4.754					
cDMARD	112,462	4.615	3974	-0.139	3974	-0.139	Dominated
ETN + MTX	150,095	5.965	41,607	1.210	37,633	1.350	34,373

a Combination cDMARD.

**TABLE 150** Severe DMARD-inadequate responder monotherapy incremental analysis presented by Pfizer

Strategy	Costs (£)	QALYs	vs. ADA		vs. next less costly		ICER (£)
			Incremental costs (£)	Incremental QALYs	Incremental costs (£)	Incremental QALYs	
cDMARD	79,837	1.570					
ADA	95,474	2.083	15,637	0.513	15,637	0.513	Dominated
ETN	98,143	2.265	18,306	0.695	2669	0.182	26,335
TCZ2	115,782	2.642	35,945	1.071	17,639	0.376	Extendedly dominated
TCZ1 <sup>a</sup>	122,013	2.963	42,176	1.393	6231	0.321	34,227

a In TCZ1 ETN was used as the next biologic; this was ADA in TCZ2.

**FIGURE 94** Cost-effectiveness acceptability curve for analysis 1 within the Pfizer submission. (AiC information has been removed.)

**FIGURE 95** Cost-effectiveness acceptability curve for analysis 2 within the Pfizer submission. (AiC information has been removed.)

**FIGURE 96** Cost-effectiveness acceptability curve for analysis 3 within the Pfizer submission. (AiC information has been removed.)

**FIGURE 97** Cost-effectiveness acceptability curve for analysis 4 within the Pfizer submission. (AiC information has been removed.)

### Pfizer's interpretation of its cost-effectiveness results

Pfizer states that:

... the primary analysis demonstrated that, based on current NICE sequential guidance and comparisons made within the analysis, a strategy in which ETN is provided after the failure of two conventional DMARDs is the most cost-effective treatment strategy at a cost-effectiveness threshold of £30,000 per QALY in the Severe DMARD-IR [inadequate responder] combination therapy, Severe DMARD-IR monotherapy and Moderate to Severe populations. The results in a Severe-DMARD-IR population appear to be consistent with previously economic evaluations conducted from a UK perspective identified in the economic SR, when limited or no HAQ progression has been assumed for bDMARDs.

In the Severe Naïve population, the ETN strategy had an ICER of £34,373 versus combination DMARD strategy. This result appears to be different from a previous economic evaluation conducted from a UK perspective, which suggested ETN + MTX may be cost effective at a £30,000 threshold when no HAQ progression is assumed for ETN + MTX.<sup>123</sup> Difference in the economic evaluations results are likely to be partially explained by difference in discount rates used, as if the alternative discount rates used in Chen et al, 2006<sup>123</sup> are implemented, then ETN + MTX does becomes a cost effective strategy at £30,000.

Pfizer reports that the secondary analyses, which were not shown in this summary, that used strategies with alternative second-line therapies and additional comparator strategies were:

... unable to change the conclusions of the primary analyses. The exception was the inclusion of an alternative 2nd line therapy in the Severe DMARD-IR [inadequate responder] combination therapy population; in this analysis ETN became the optimal strategy at a cost-effectiveness threshold of £20,000 per QALY.

### Roche

The Roche submission evaluated a subpopulation not defined in the scope as a MTX-intolerant or -contraindicated RA population, which was in essence analyses 4 and 5 analysed jointly. This was denoted analysis 8.

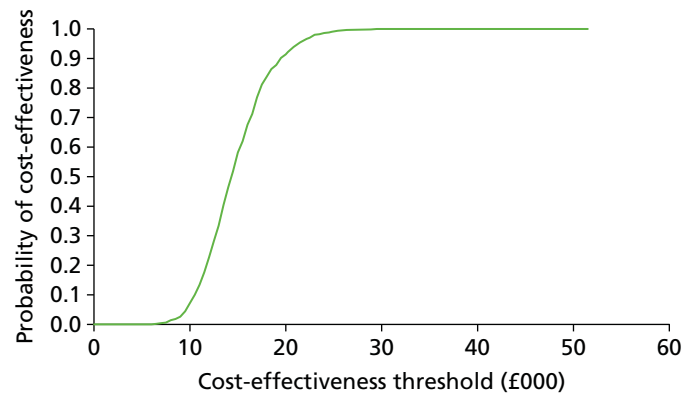
Roche's base case evaluated only adding TCZ as the first-line treatment to an existing sequence. The Assessment Group comments that the existing sequence is not recommended by NICE, as three bDMARDs were assumed, and also that sequences of treatment should have been evaluated. For these reasons the results presented by Roche should be treated with caution.

The probabilistic results are shown in *Table 151*. The CEAC is shown in *Figure 98*.

**TABLE 151** The probabilistic sensitivity results supplied by Roche for analysis 8

Model output	Standard of care	TCZ strategy	Incremental results	ICER (£ per QALY)
Total QALYs	8.477	9.328	0.8503	
Total cost (£)	123,390	135,736	12,346	14,520

Data are shown to the level of accuracy available in the source material.



**FIGURE 98** The CEAC produced by Roche for analysis 8.

### ***Roche's interpretation of its cost-effectiveness evidence***

Roche states that:

*... the cost-effectiveness analysis results suggest that the use of first line tocilizumab for DMARD-IR [inadequate responder] RA patients who are intolerant or unsuited to MTX represents a cost-effective use of resources within the NHS. Overall, the results are robust to changes in cost and clinical parameters within the economic model, and moreover the ICERs remain cost-effective across a range of alternative methods of comparison (comparing sequences, comparing individual biologics with one another, comparing biologics to palliation alone).*

### **UCB Pharma**

UCB Pharma presented analyses for the populations in the scope for which CTZ was licensed. These are analyses 1, 2, 4 and 5. The Assessment Group comments that this analysis omits a fundamental comparison, which is that of bDMARDs versus cDMARDs. It is unclear whether or not the model submitted by UCB Pharma would estimate whether or not bDMARDs are cost-effective given that the remaining submissions comment that the ICER for population 2 is generally similar to that for population 3, and that UCB Pharma estimates that CYZ is not cost-effective in population 3.

The base-case results for analysis 1 are given in *Table 152*, with the CEAC reproduced in *Figure 99*.

The results for analyses 2 and 5 were combined in *Table 153*. No CEACs for these analyses were provided.

UCB Pharma's base-case results for analysis 4 are provided in *Table 154*, with the CEAC shown in *Figure 100*.

### ***UCB Pharma's interpretation of its cost-effectiveness evidence***

UCB Pharma states that:

*... the base case analysis of the severe disease activity population indicated that certolizumab pegol has the highest probability of being cost-effective of all the combination therapies and monotherapies considered, at all willingness-to-pay thresholds between £10,000 and £100,000 per QALY. At £20,000 per QALY, CZP in combination with MTX or as monotherapy is the most cost-effective treatment with a probability of 100%.*

**TABLE 152** Base-case results for combination treatments (severe disease activity population) provided by UCB Pharma

Therapy	Mean costs (£)	Difference in costs (CTZ vs. treatment) (£)	Mean QALYs	Difference in QALYs (CTZ vs. treatment)	ICER (CTZ vs. treatment) (£)	Incremental values	Probability of cost-effectiveness at WTP of £20,000/QALY (%)
Combination therapies							
GOL + MTX	126,900	929	7.092	0.193	£4,822	Optimal at WTP threshold < £4822	0
CTZ + MTX	127,829	–	7.284	–	–	Optimal at WTP threshold > £4822	100
ADA + MTX	128,267	–437	7.175	0.109	CTZ dominates	CTZ dominates	0
IFX + MTX	128,542	–713	7.024	0.260	CTZ dominates	CTZ dominates	0
ETN + MTX	128,623	–793	7.184	0.100	CTZ dominates	CTZ dominates	0
TCZ + MTX	139,532	–11,703	7.106	0.179	CTZ dominates	CTZ dominates	0
ABT + MTX	143,982	–16,152	7.008	0.276	CTZ dominates	CTZ dominates	0

WTP, willingness to pay.

**FIGURE 99** Base-case CEAC for analysis 1 produced by UCB Pharma. (AiC information has been removed.)**TABLE 153** Base-case results for combination treatments (moderate disease activity population) provided by UCB Pharma

Therapy	Mean costs (£)	Difference in costs (CTZ vs. PBO) (£)	Mean QALYs	Difference in QALYs (CTZ vs. PBO)	ICER (CTZ vs. PBO) (£)	Probability of cost-effectiveness at WTP of £20,000/QALY (%)
Combination cDMARDs therapies: analysis 2						
PBO + cDMARD	90,241	–	8.760	–	–	100
CTZ + cDMARD	120,217	29,976	9.387	0.627	47,821	0
Combination MTX therapies: analysis 5						
PBO + MTX	89,801	–	8.726	–	–	100
CTZ + MTX	116,603	26,802	9.270	0.544	49,226	0

WTP, willingness to pay.

**TABLE 154** Base-case results for monotherapy treatments (severe disease activity population) provided by UCB Pharma

Therapy	Mean costs (£)	Difference in costs (CTZ vs. treatment) (£)	Mean QALYs	Difference in QALYs (CTZ vs. treatment)	ICER (CTZ vs. treatment) (£)	Incremental values	Probability of cost-effectiveness at WTP of £20,000/QALY (%)
Monotherapies							
ADA	121,595	3019	6.846	0.315	9587	Optimal at WTP threshold < £9587	0
CTZ	124,614	–	7.161	–	–	Optimal at WTP threshold > £9587 and < £962,778	100
ETN	127,185	–2571	7.163	–0.003	£962,778 (ETN vs. CZP)	Optimal at WTP threshold > £962,778	0
TCZ	138,971	–14,357	7.086	0.075	CTZ dominates	Extended dominance by CTZ and ADA	0

WTP, willingness to pay.

**FIGURE 100** Base-case CEAC for analysis 4 produced by UCB Pharma. (AiC information has been removed.)

### Budget impact

This section details the budget impact analyses undertaken by the manufacturers. No comment will be made on the Bristol-Myers Squibb, MSD or Roche submissions as these did not include budget impact analyses. For brevity, only summary figures for the base case will be provided rather than the methods used in the calculations. In summary, each submission predicted that the expenditure on RA interventions would probably increase owing to the increased population that would be eligible if a positive recommendation was issued for the moderate to severe RA population.

### AbbVie

Table 155 reproduces the budget impact estimated by AbbVie assuming ADA was used for all eligible patients. The initial year is inflated owing to treating all incident cases.

### Pfizer

Pfizer's summarised results of the number of patients requiring treatment each year is reproduced in Table 156.

**TABLE 155** The incremental budget impact for ADA when used for eligible RA patients with moderate and severe disease activity over the next 5 years in England and Wales as estimated by AbbVie

Parameter	2013	2014	2015	2016	2017
Incremental annual budget impact for RA patients with moderate and severe disease activity (£)	258,556,867	149,487,523	153,870,726	158,282,136	162,723,747



**TABLE 156** The number of patients requiring treatment each year as estimated by Pfizer

Category	2014	2015	2016
Prevalence	58,050	58,526	58,993
Incidence	1714	1729	1742
Total	59,764	60,254 <sup>a</sup>	60,735
a Rounded.			

## UCB Pharma

UCB Pharma states that:

*It was estimated that the current use of the recommended biological therapy for the severe disease activity population would result in a budget impact of £225 million in 2013, rising to £234 million in 2017. A sensitivity analysis assuming an increased CZP use compared to the base case led to budgetary savings of £2.6 million over 5 years.*

## Independent economic assessment

### Description of the Assessment Group's model

None of the models submitted by the manufacturers replicated the clinical reality within England and Wales to the satisfaction of the Assessment Group. Primarily, this is because the majority of models assumed that the efficacy of the intervention was based on improvements in ACR, whereas NICE guidance has defined stopping rules where an intervention is stopped unless a DAS28 reduction of 1.2 points<sup>22</sup> is achieved. The criterion of achieving a 1.2-point reduction in DAS is associated with a good or moderate EULAR response.

Furthermore, clinicians in the UK predominantly measure EULAR, rather than ACR responses. The use of EULAR is recommended by the British Society for Rheumatology and British Health Professionals in Rheumatology, which consider the EULAR response to be an evidence-based and validated measure of response to treatment.<sup>291</sup>

For these reasons the Assessment Group constructed a model in which the assessment of treatment response was based on EULAR response at 6 months. This also alleviates the need for assumptions to be made by decision-makers regarding the proportion of patients who remain on treatment following each category of ACR response.

Two of the submissions, those by Bristol-Myers Squibb<sup>286</sup> and UCB Pharma,<sup>237</sup> did attempt to model reductions in DAS28; however, neither was considered fully appropriate. The model by Bristol-Myers Squibb did not assess all of the questions within the decision problem, had minimal information on the NMA performed and additionally was written in SIMUL8 (a DES software which is not included in the list of current NICE-recommended packages and thus this platform could not be used by the AG). The model by UCB Pharma was a Markov cohort model that treated all patients as homogenous and would not have the flexibility desired for employing patient-level covariates to represent the heterogeneity of patient outcomes.

The description of the Assessment Group's model is conducted using the same heading as employed when describing the manufacturers' models, bar the cost-effectiveness results and cost implications headings that form separate sections of this report. Where appropriate, reasons why the Assessment Group has taken a different approach to the manufacturers will be provided.

The Assessment Group was granted access to data provided by the BSRBR and also from the ERAS and the US National Data Bank for Rheumatic Diseases (NDB), which were used to assess key model parameters and correlations. Specific systematic reviews were undertaken for specific parameters and when these produced relevant information the papers identified are discussed. Contact was also made with key researchers in the field to identify pertinent and/or ongoing research with preliminary findings in the public domain.

### **The decision problem addressed**

The Assessment Group has undertaken evaluations of all the subpopulations defined in the scope, which equate to the defined analyses 1–6. The Assessment Group deviated from the scope for population 1; this was deemed necessary as the defined populations were not exhaustive and did not specify into which population a patient who had received cDMARDs but not MTX would fall. On clinical advice such patients were assumed to be MTX naive. The decision problem addressed by the Assessment Group matches that undertaken by AbbVie and UCB Pharma (for the populations for whom CTZ is licensed).

### **The strategies modelled**

This Assessment Group model considers strategies of sequencing treatments but acknowledges that, owing to the scope, NICE can make recommendations only on the first-line use of bDMARDs. Therefore, this report will assume that NICE guidance after the first biologic treatment is routinely followed. This means that RTX with MTX will be used after failure of the first bDMARD should a patient be able to take MTX and following this a patient receives TCZ and MTX if not previously received.

For simplicity, it was assumed that it would be known whether or not a patient required monotherapy at the time of the first bDMARD initiation based on their experience of cDMARDs and also that any patient who could tolerate MTX could also receive RTX. This would not be correct when analysing population 1, adults with severe active RA not previously treated with cDMARDs, but is likely to be of limited impact as (1) it would be apparent only if bDMARDs were recommended in advance of intensive cDMARDs, and (2) the effect would be dampened as each treatment sequence would have to replace RTX with a bDMARD that is licenced for use in monotherapy and any impact would be relatively equal across all strategies.

Although the Assessment Group model can incorporate sequences of up to seven treatments, for simplicity it was decided that modelling large number of cDMARDs would not be overly informative. The rationale for this is that there are insufficient data on the effectiveness of cDMARDs after either bDMARDs or multiple cDMARDs. For this reason, once a patient had received intensive cDMARD therapy and/or the allotted bDMARDs within the sequence, patients were assumed to have one further cDMARD (typically MTX, but an alternative cDMARD if MTX was not suitable) before moving to 'non-biologic therapy' (NBT), which was a term defined to encompass a selection of treatments that clinicians may feel is appropriate for individual patients. It was assumed that NBT would be associated with no initial EULAR response, unlike MTX where the results from the NMA indicated that MTX had a significant EULAR response.

This description is in line with the data on HAQ progression that were presented by Norton *et al.*<sup>292,293</sup> Given that this assumption applies to all strategies, the contraction of a cDMARD sequence to NBT is unlikely to influence the results and should allow an easier interpretation of the results.

For populations 2 and 3, it was assumed that all patients would have previously received intensive cDMARD therapy prior to the first bDMARD and thus this intervention was not explicitly modelled.

It is acknowledged that these represent simplified pathways and that for individuals there may be alternative strategies, but the Assessment Group and their clinical advisors feel that these are fairly representative and these are also relatively in line with the typical strategies presented by the manufacturers.

**TABLE 157** Broad strategies considered possible for patients who could receive MTX

Population	Strategy
1	MTX → intensive cDMARDs → NBT MTX → intensive cDMARDs → bDMARD <sup>a</sup> + MTX → RTX + MTX → TCZ + MTX → MTX → NBT MTX → intensive cDMARDs → TCZ + MTX → RTX + MTX → MTX → NBT bDMARD <sup>b</sup> + MTX → RTX + MTX → TCZ + MTX → MTX → intensive cDMARDs → NBT
2 and 3	MTX → NBT bDMARD <sup>a</sup> + MTX → RTX + MTX → TCZ + MTX → MTX → NBT TCZ + MTX → RTX + MTX → MTX → NBT

a Excluding TCZ.

b Excluding ABT, CTZ and TCZ.

Table 157 provides the broad strategies that were deemed appropriate by the Assessment Group for consideration in patients who could receive MTX.

Table 158 provides the broad strategies that were deemed appropriate by the Assessment Group for consideration in patients who could not receive MTX.

The broad strategies were distilled into the following strategies which were evaluated (Tables 159–162). The Assessment Group believes that these provide representative results. These strategies are not

**TABLE 158** Broad strategies considered possible for patients who could not receive MTX

Population	Strategy
1	cDMARD → intensive cDMARDs → NBT bDMARD <sup>a</sup> → bDMARD <sup>b</sup> → cDMARD → intensive cDMARDs → NBT
2 and 3	cDMARDs → NBT bDMARD → bDMARD <sup>b</sup> → cDMARD → NBT

a Excluding ABT, CTZ and TCZ.

b Excluding TCZ.

**TABLE 159** The strategies evaluated for populations 2 and 3 for those who can receive MTX

Strategy	First-line treatment	Second-line treatment	Third-line treatment	Fourth-line treatment	Fifth-line treatment
Strategy 1	MTX	NBT			
Strategy 2	ABT i.v. + MTX	RTX + MTX	TCZ + MTX	MTX	NBT
Strategy 3	ABT s.c. + MTX	RTX + MTX	TCZ + MTX	MTX	NBT
Strategy 4	ADA + MTX	RTX + MTX	TCZ + MTX	MTX	NBT
Strategy 5	CTZ + MTX	RTX + MTX	TCZ + MTX	MTX	NBT
Strategy 6	ETN + MTX	RTX + MTX	TCZ + MTX	MTX	NBT
Strategy 7	GOL + MTX	RTX + MTX	TCZ + MTX	MTX	NBT
Strategy 8	IFX + MTX	RTX + MTX	TCZ + MTX	MTX	NBT
Strategy 9	TCZ + MTX	RTX + MTX	MTX	NBT	

**TABLE 160** The strategies evaluated for populations 2 and 3 for those who cannot receive MTX

Strategy	First-line treatment	Second-line treatment	Third-line treatment	Fourth-line treatment	Fifth-line treatment
Strategy 1	SSZ	NBT			
Strategy 2	ADA	ETN	SSZ	NBT	
Strategy 3	CTZ	ETN	SSZ	NBT	
Strategy 4	ETN	ADA	SSZ	NBT	
Strategy 5	TCZ	ETN	SSZ	NBT	

**TABLE 161** The strategies evaluated for population 1 for those who can receive MTX

Strategy	First-line treatment	Second-line treatment	Third-line treatment	Fourth-line treatment	Fifth-line treatment	Sixth-line treatment	Seventh-line treatment
Strategy 1	MTX	Intensive cDMARDs	NBT				
Strategy 2	ETN + MTX	RTX + MTX	TCZ + MTX	MTX	Intensive cDMARDs	NBT	

**TABLE 162** The strategies evaluated for population 1 for those who cannot receive MTX

Strategy	First-line treatment	Second-line treatment	Third-line treatment	Fourth-line treatment	Fifth-line treatment	Sixth-line treatment
Strategy 1	SSZ	NBT				
Strategy 2	ETN	ADA	NBT			

significantly different from those of the manufacturers bar the exclusion of named cDMARDs at the end of the sequence. Given the large uncertainty in the efficacy of the cDMARDs in post bDMARD or post intensive cDMARDs the inclusion of specific interventions may be introducing spurious accuracy.

For population 1, in order to ease interpretation of results the analyses have been conducted assuming that ETN is generalisable in terms of costs and QALYs to all other bDMARDs. This assumption is given some support by the results for populations 2 and 3 presented in *Results*. The cost-effectiveness of a bDMARD first option compared with an option of bDMARD use after initial intensive cDMARD use is the analysis presented for populations 2 and 3.

### Model structure/time cycle

A simplified schematic of the Assessment Group's model is shown in *Figure 101*. The model is individual patient based, written in Microsoft Excel and uses a DES approach. Therefore, a time cycle was not employed. The model allows only legitimate HAQ scores (the 25 points defined in the 0–3 range) with time to a change in HAQ score being a competing risk. The advantage of using discrete HAQ scores means that if some outputs (such as costs, utility or risk of mortality) are assumed, related by HAQ, there is no need to be continually updating the output as a HAQ score is assumed to linearly progress between legitimate HAQ points.

The Assessment Group model differs substantially from that of the manufacturers, as it is EULAR based and uses large databases for population of key parameters such as the initial HAQ changes conditional on EULAR response, and HAQ trajectory based on EULAR response.

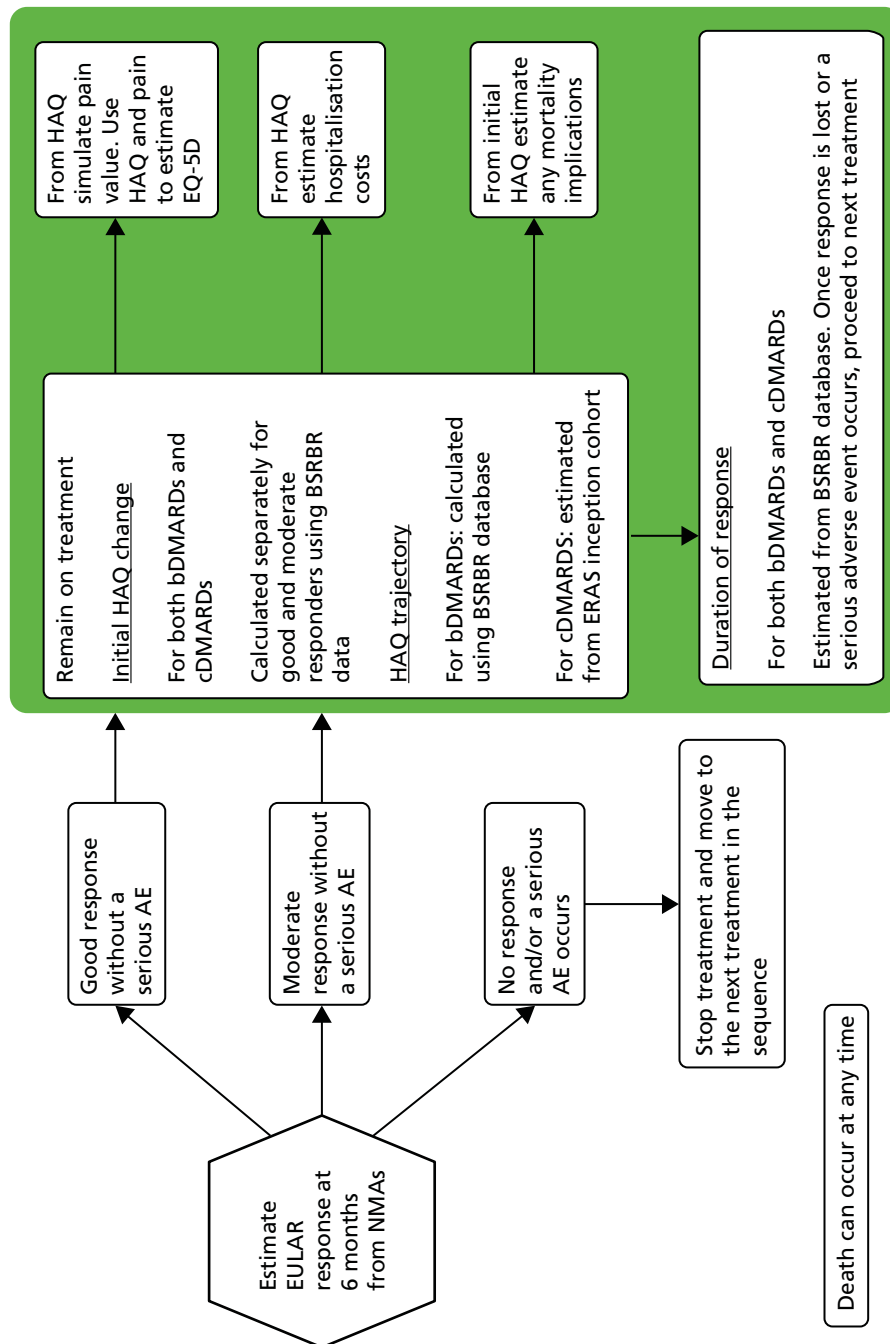


FIGURE 101 Conceptual simplified schematic of the modelling process.

### Time horizon

The Assessment Group model employs a lifetime patient horizon, but assumes that no patient will live beyond 101 years. This is similar to the approaches undertaken in the manufacturer's submission.

### Perspective

The Assessment Group model employs a direct NHS and Personal Social Services perspective, which is in line with that adopted by the manufacturers.

### Discounting

The Assessment Group model used discount rates of 3.5% per annum for both costs and benefits as recommended within both the 2013 NICE methods guide<sup>274</sup> and the 2008 methods guide.<sup>220</sup> Sensitivity analyses were undertaken assuming values of 6.0% for costs and 1.5% for benefits.

### Population characteristics

The Assessment Group samples patients who are MTX experienced from the BSRBR, which allows correlation to be maintained between the following characteristics: age; sex; disease duration; DAS; previous DMARDs; HAQ; and weight. Individual patients were resampled until the patient met the criteria for the population being analysed. This approach significantly increased the running times for those patients with a DAS between 3.2 and 5.1, as these represented a minority of patients in the BSRBR and required considerable resampling.

Having sampled the patient's characteristics, the HAQ score is set at a legitimate value. As an example, suppose that a non-legitimate HAQ of 1.600 was simulated. Sampling the probabilities of the bordering legitimate HAQ scores in inverse relation to their distance from 1.6 (20% chance of being 1.5 and 80% chance of being 1.625) would retain the mean value but allow legitimate HAQ scores. Thus, in this example we would simulate 80% of patients having a HAQ score of 1.625 with the remaining patients having a HAQ of 1.5 rather than 100% having a HAQ of 1.600.

The Assessment Group populated patients' characteristics based on the BSRBR, whereas a number of manufacturers have used the patient characteristics from their pivotal trials to populate their mathematical models. The advantage of the Assessment Group's approach is that it is a much larger data set (7250 patients), it is representative of people treated in England and Wales and the correlation structure between parameters is maintained. A disadvantage is that the data set for moderate to severe RA patients is much smaller, with approximately 500 patients, although this is not small relative to the numbers of patients within the RCTs.

For patients who are MTX naive it was deemed that the BSRBR database was not an appropriate data source, as this would contain a very small number of such patients. Both AbbVie and Pfizer presented population characteristics for MTX-naive patients with a DAS > 5.1. Of the two estimates, that of Pfizer based on the COMET trial<sup>81</sup> was deemed more appropriate, as the disease duration was of 1 year, compared with 11.28 years reported by AbbVie (citing Breedveld *et al.*<sup>109</sup>), which was thought to be a long period without having experienced MTX. The estimate from Pfizer had a greater HAQ at baseline (1.70 compared with 1.38) and were on average younger (a mean age of 51.4 years compared with 60 years).

### Costs of the interventions

These costs are similar to those used by the manufacturers; however, there are two comments worth noting: (1) that the Assessment Group takes all PASs into consideration whereas the majority of manufacturers do not; and (2) that a number of manufacturers have assumed a fixed weight per person, which can underestimate the costs of weight-based interventions. The intensive cDMARDs strategy was costed as triple cDMARD plus prednisolone therapy. This is consistent with the intensive cDMARD therapy provided in the TICORA study.<sup>294</sup> The treatment included MTX (20 mg weekly), HCQ (6.5 mg/kg daily), SSZ (3 g daily) and prednisolone (oral, 7.5 mg daily). The total treatment cost in the response period is £3365.32, with a regular monthly treatment cost of £491.34.

An additional treatment option is listed in *Tables 161* and *162* that is not an intervention within the NICE scope: RTX plus MTX.

The costs of other drugs used within the sequence (RTX and the costs of cDMARDs) are provided in *Table 163*.

### Costs of administration and monitoring

The administration costs of infusions were taken from TA247,<sup>26</sup> in which the final appraisal determination stated that 'the manufacturer's revised estimate of £154 was acceptable'. This estimate (of 60 minutes infusion time) was also applied to ABT and IFX in the absence of a robust relationship between costs and infusion times. This assumption may be favourable to IFX and unfavourable to ABT, as the recommended infusion times are at least 2 hours and 30 minutes respectively. The final appraisal determination for TA247<sup>26</sup> did not comment on the assumption that 10% of s.c. injections would be performed by district nurses and the Assessment Group has assumed that these were also thought acceptable. This resulted in an average administration cost per s.c. injection of £2.61. Neither of the administration costs has been inflated as they were relatively recent and there is uncertainty in the direction of costs in the current economic climate. The value used by the Assessment Group is in broad agreement with the majority of manufacturers.

The assumed monitoring costs are provided in *Table 164*. These are assumed equal for MTX and bDMARDs. It is possible that the estimate of one hospital outpatient appointment per month may be an overestimate. However, because, on clinical advice, this was assumed, in both the bDMARD and the cDMARD arms, and there was no benefit on mortality assumed, there would be no impact on the cost-effectiveness ratio were this value to be changed to a different value.

**TABLE 163** The costs of cDMARDs and RTX

Treatment	Dose regimen	Cost per cheapest dose (£) <sup>a</sup>	Cost of first 6 months (£) <sup>b</sup>	Subsequent annual treatment cost (£) <sup>b</sup>
RTX	2000 mg every 9 months	3492.60 (2000 mg)	3492.60	4656.80 <sup>c</sup>
HCQ	6.5 mg/kg per day (maximum 400 mg per day)	0.17 (400 mg)	31.35 <sup>d</sup>	62.70 <sup>d</sup>
MTX	7.5 mg per week escalated by 2.5 mg per week up to 20 mg per week	0.80 (20 mg)	19.32	41.57
Prednisolone	7.5 mg per day	1.07 (7.5 mg)	196.25	392.50
SSZ	500 mg per day escalated by 500 mg per week up to 3000 mg per day	0.79 (3000 mg)	131.38	290.17
Intensive combination DMARD therapy <sup>e</sup>	HCQ + MTX + prednisolone + SSZ (doses as per monotherapy treatments)	N/A	378.31	786.94
Palliative care/rescue therapy	N/A <sup>e</sup>	Assumed 60 per month <sup>f</sup>	360	720

N/A, not applicable.

a Note that dose can be daily or weekly (see dose regimen column).

b No administration or monitoring costs included.

c RTX is administered at discrete 9-month periods.

d Using BSRBR average weight of 73 kg for illustration.

e Intensive combination DMARD therapy is assumed to be the individual regimens for HCQ, MTX, prednisolone and SSZ combined.

f An approximation of monthly 'post-biologic' cDMARD therapy (LEF, GLD, CYC, etc.).

**TABLE 164** The monitoring costs assumed in the Assessment Group model

Monitoring component	FBC	ESR	BCP	CXR	Urinalysis	Hospital outpatient attendance	Total cost (£)
Assumed cost (£)	3 <sup>a</sup>	3 <sup>a</sup>	3 <sup>a</sup>	33 <sup>a</sup>	0.09 <sup>b</sup>	128 <sup>b</sup>	
MTX monitoring: before treatment initiation	1	1	1	1	0	1	170
MTX monitoring: first 6 months of treatment	10	0	10	0	0	10	1700
Monthly monitoring cost	1	0	1	0	0	1	134

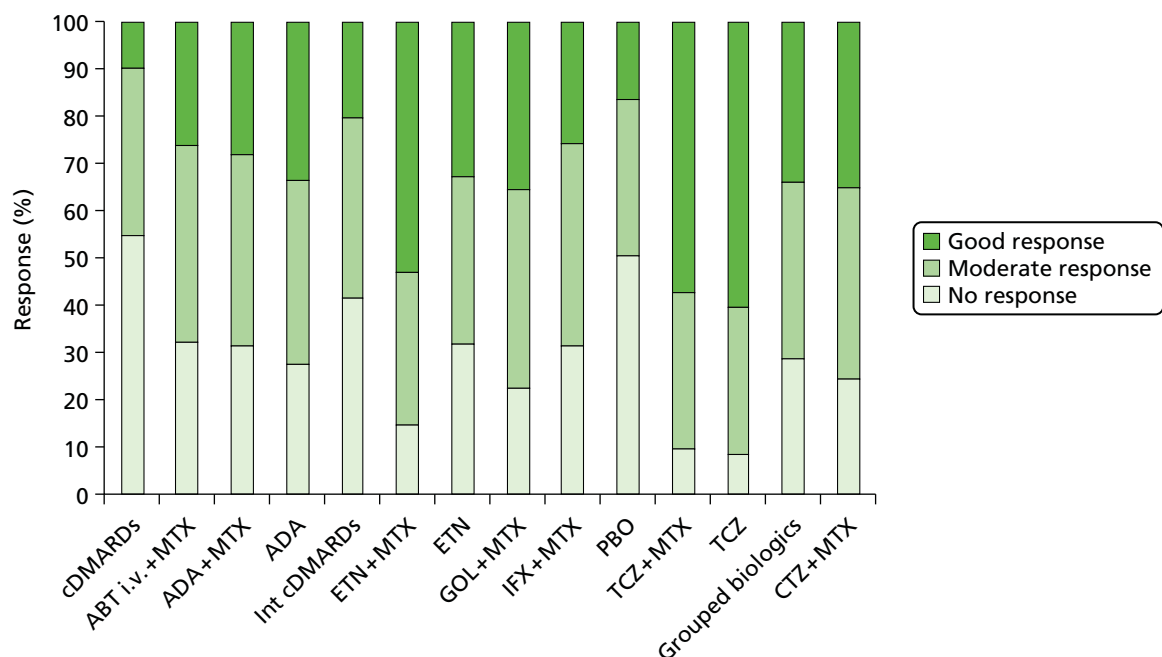
BCP, biochemical profile; CXR, chest X-ray; FBC, full blood count.  
a NHS reference costs 2012.<sup>295</sup>  
b Malottki *et al.*<sup>171</sup>

### Comparative treatment efficacy (network meta-analysis)

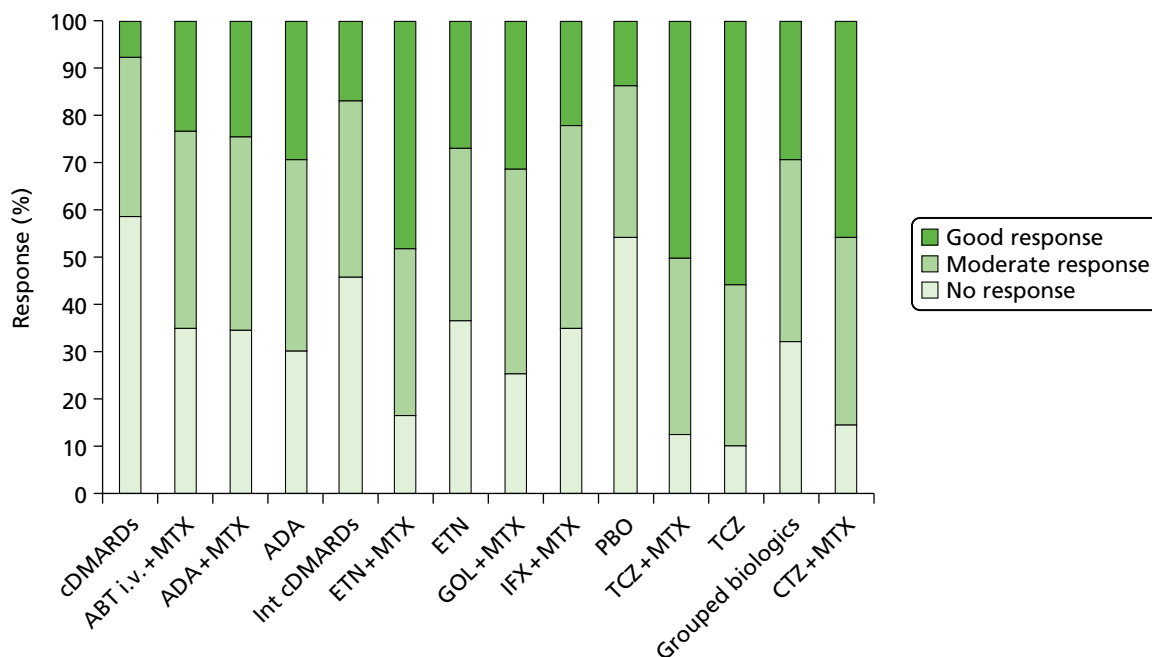
The NMA undertaken by the Assessment Group has been detailed in *Chapter 3, Network meta-analysis results*. For information graphical depictions of the estimated proportions of EULAR response are provided in *Figures 102* and *103* for EULAR and in *Figures 104–109* for ACR mapped to EULAR. It is stressed that these figures do not reflect the considerable uncertainty in the values and reflect mean estimates only.

The Assessment Group model reflects current NICE guidance and UK practice by simulating patient response in terms of EULAR categories (none, moderate, good). However, the evidence on clinical effectiveness does not universally report EULAR responses, with ACR categories widely used. In order to inform the evidence synthesis and to be able to make use of the entirety of the evidence base in the most informed and efficient manner, we sought evidence of the relationship between these response categories using individual patient-level data.

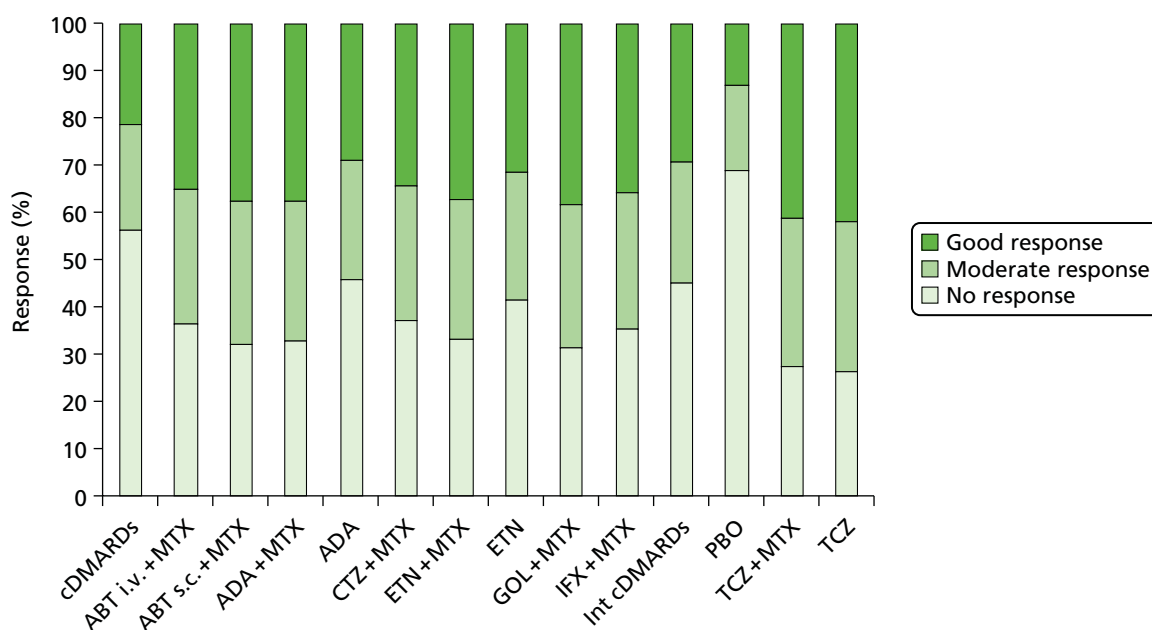
The Veterans Affairs Rheumatoid Arthritis (VARA) registry provided such estimates to the Assessment Group as AiC. VARA is a multicentre, US database of veterans aged  $\geq 19$  years (*Table 165*).

**FIGURE 102** Estimated mean EULAR responses in cDMARD-experienced patients (main analyses). Int, intensive.

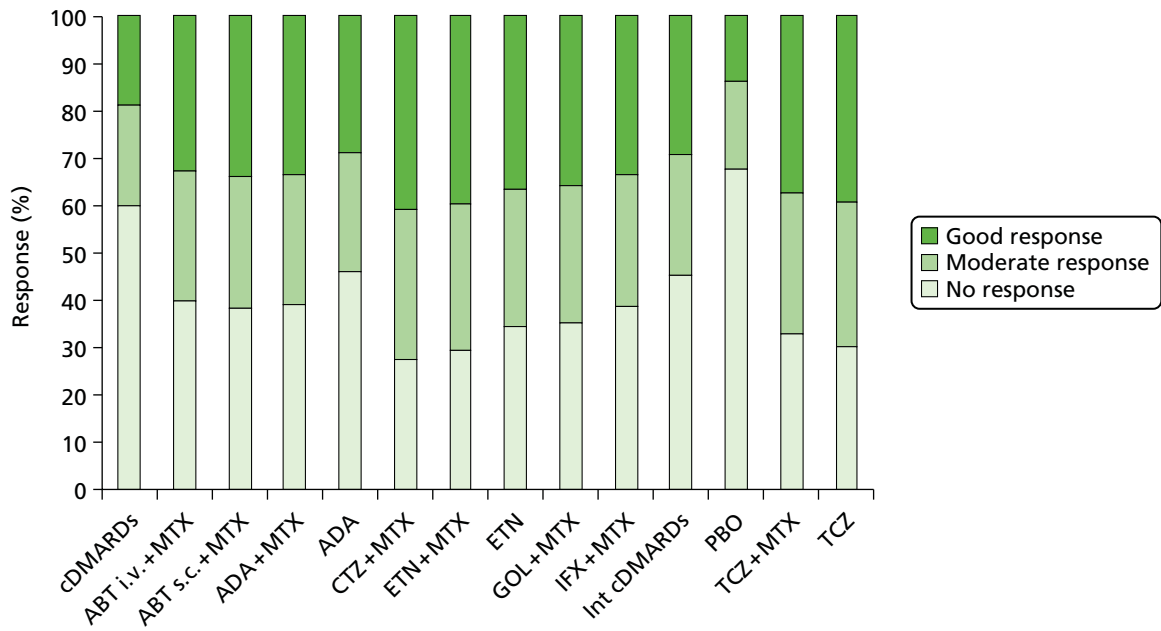




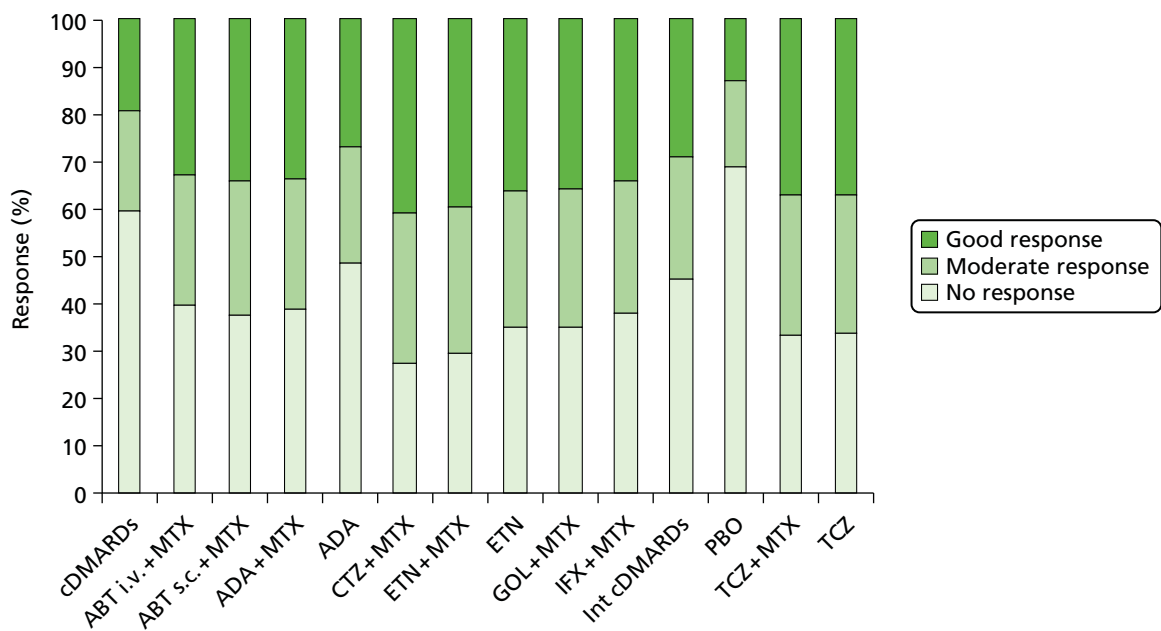
**FIGURE 103** Estimated mean EULAR responses in cDMARD-experienced patients (main analyses + RCTs with a small level of bDMARD use). Int, intensive.



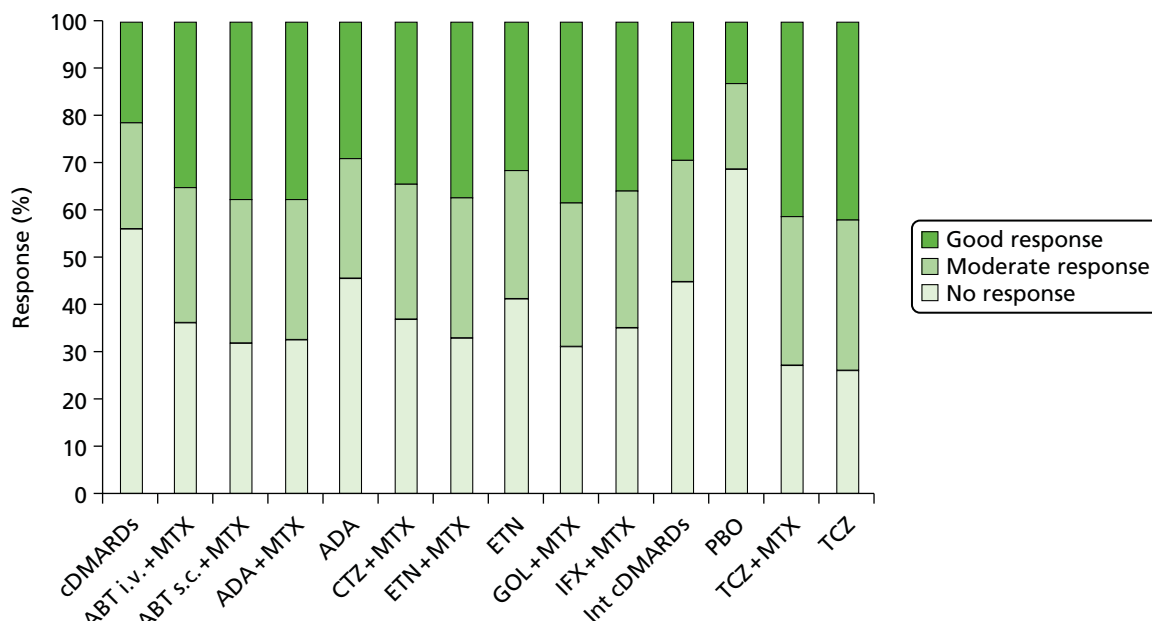
**FIGURE 104** Estimated mean EULAR response in cDMARD-experienced mapped patients from ACR trials (main analyses). Int, intensive.



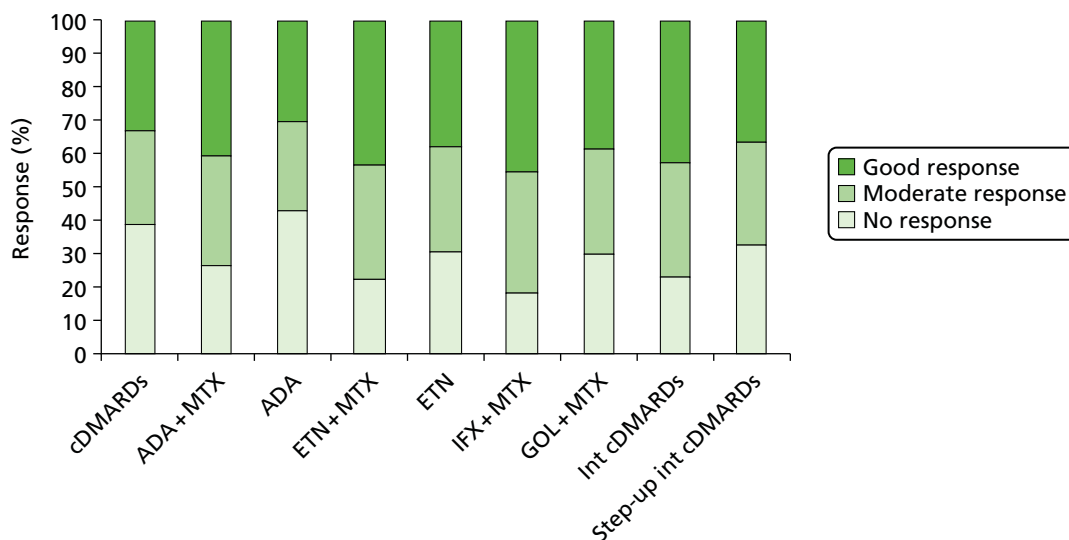
**FIGURE 105** Estimated mean EULAR response in cDMARD-experienced mapped patients from ACR trials (main analyses + RCTs with a small level of bDMARD use). Int, intensive.



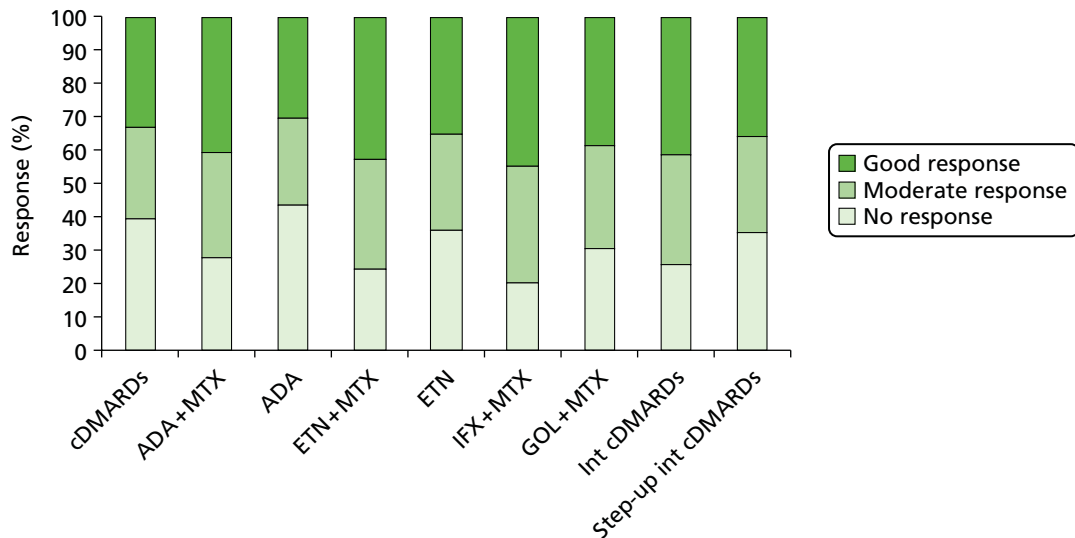
**FIGURE 106** Estimated mean EULAR response in cDMARD-experienced patients mapped from ACR trials (main analyses + RCTs with a small level of bDMARD use and also allowing a trial with low MTX background use). Int, intensive.



**FIGURE 107** Estimated mean EULAR response in cDMARD-experienced patients mapped from ACR trials (main analyses + RCTs with low MTX background use). Int, intensive.



**FIGURE 108** Estimated mean EULAR response in cDMARD-naive patients mapped from ACR trials in cDMARD-naive patients. Int, intensive.



**FIGURE 109** Estimated mean EULAR response in cDMARD-experienced patients mapped from ACR trials in cDMARD-naive patients including RCTs with a proportion of cDMARD-experienced patients. Int, intensive.

**TABLE 165** The relationship between EULAR responses and ACR responses in the VARA database

Patient category	Less	ACR20	ACR50	ACR70	Total
EULAR ESR, all patients					
None	755	4	2	0	759
Moderate	136	27	2	2	163
Good	57	26	10	2	83
EULAR ESR, severe active					
None	72	2	0	0	74
Moderate	33	19	0	0	52
Good	3	9	5	1	12

Analyses were undertaken (1) using both versions of EULAR response (CRP based and ESR based) and (2) for all patients and just those with DA28 > 5.1 at baseline. There was great similarity between the CRP- and ESR-based measures. *Table 165* reports ESR-based values, which were used in the economic model as it is this measure that was reported most regularly in the relevant RCTs.

By assuming that the relationships shown in *Table 165* were correct it was possible to use data taken from the NMA of ACR by mapping these onto EULAR data and subsequently using the same procedures as for the Assessment Group model.

The following assumptions have been made regarding the efficacy of RTX based on work by Malottki *et al.*<sup>171</sup> *Table 46* in Malottki *et al.*<sup>171</sup> reports that in terms of ACR20, ACR50, ACR70 and withdrawal for any reason that the indirect comparison of RTX versus ABT either favoured RTX, albeit with wide CIs, or there was no difference. Given these data, the efficacy of RTX was assumed equal to i.v. ABT.

There are no marked differences between the results produced by the Assessment Group and the combined evidence presented by the manufacturers.

### Responder criteria

The Assessment Group model is based on EULAR response category (good/moderate/none) in order to reflect current NICE guidance on biologic therapies in RA and to align more closely to UK clinical practice in terms of the assessment of response to therapies. The estimated probability of each EULAR response has been taken from the NMAs conducted by the Assessment Group. This allowed analyses to be conducted purely on EULAR data or estimated based on ACR responses in order to encompass a wider evidence base. This differs from the majority of submissions, which assumed that ACR responses would be used to determine whether or not patients were responders (i.e. there is an implicit stopping rule associated with ACR and its relationship to EULAR criteria that underpins these models, though this is not explicitly stated).

### Health Assessment Questionnaire/European Quality of Life-5 Dimensions changes in relation to response levels

For each simulated individual the model allocates a change in HAQ from baseline, dependent on the individual's EULAR response. Different sources for these values were considered, including the option of allocating different values for those on bDMARDs compared with those on cDMARDs. However, in the base case we used the same values for both cDMARDs and bDMARDs.

In the base case we used values modelled from the BSRBR. We assumed zero change for non-responders, a HAQ reduction of 0.317 (SE 0.048) for moderate responders and 0.672 (SE 0.112) for good responders (Table 166). These values were obtained from modelling data from the BSRBR and equate to predictions for a person with the characteristics equivalent to the mean of the overall sample. Full details of the approach are provided in *Health Assessment Questionnaire trajectory following initial response* because the method estimates both 6-month and subsequent HAQ changes in a single statistical approach.

### bDMARDs

For patients with the mean characteristics of the actual sample of EULAR moderate responders in the BSRBR, the statistical model predicts a change from 2.08 to 1.79 (a change of 0.29). The mean change in the raw data for this group is from 2.08 to 1.75 (a change of 0.33). For patients with the mean characteristics of the actual sample of EULAR good responders the statistical model predicts a change from 1.81 to 1.27 (a change of 0.54). The mean change in the raw data for this group from 1.81 to 1.26 (a change of 0.55). These data are provided to demonstrate the fact that the observed and predicted values are extremely similar. As the patients sampled in the cost-effectiveness model have the mean characteristics of the entire BSRBR bDMARDs-treated cohort and there is no mechanism to link those characteristics to the probability of EULAR response it is appropriate to use the values in Table 166. This could favour bDMARDs as the HAQ change associated with a good EULAR response is higher.

The statistical model that estimates HAQ change at 6 months and beyond, conditional on EULAR response category, is designed to do so at the individual patient level. However, as the School of Health and Related Research (ScHARR) model is not a true patient-level model in the sense that many of the functions in fact are programmed to estimate the average course of a patient, and because using this statistical model at the patient level substantially increased computational run time, we instead used the mean 6-month HAQ improvement for all patients. This was calculated by setting all characteristics at their mean values and assuming that the model error and mean random effect were both set to zero.

**TABLE 166** Mean HAQ change by EULAR response category used in the model

EULAR response	Mean	SE
None	-0.000	-
Moderate	-0.317	0.048
Good	-0.672	0.112

The statistical model estimating initial response is calculated at the individual patient level; however, as the data for cDMARDs were only at the aggregate level, aggregate data for bDMARDs were used. Without this adaptation the results would be unfavourable to bDMARDs as individual patients could be predicted to have a HAQ increase despite a good EULAR response, and when this is combined with the non-linear mapping of HAQ to utility such patients would have a disproportionate weight when calculating the average QALYs.

### cDMARDs

In the base-case model the same values were applied for cDMARDs as for bDMARDs.

In addition, the mean HAQ improvements for patients on cDMARDs according to their EULAR response between baseline and 6 months was calculated from the ERAS data set. These data are shown in *Table 167* for all patients between baseline and 6 months later.

It is seen that the average HAQ improvement for both moderate and good EULAR responses were markedly larger than that for no EULAR response and are relatively close to each other. Given the degree of uncertainty surrounding these mean values, it was possible in some instances that the HAQ improvement for those with a moderate EULAR response was greater than those with a good EULAR response.

The use of the modelled data for the entire BSRBR cohort for all treatments and for both those with moderate and those with severe active disease has the advantage of avoiding this potential anomaly, it reduces the running time of the model, and it provides results that are closely aligned to those observed in the BSRBR and ERAS data sets. For EULAR moderate responders the value we used (average HAR improvement 0.32) is close to that observed for moderate responders in the BSRBR (average HAR improvement 0.33). This is a smaller improvement in HAQ than observed in the ERAS data set (0.51). For EULAR good responders the value used (average HAQ improvement 0.67) was closer to the ERAS values (average HAR improvement 0.65) and significantly higher than the values seen for good responders in the BSRBR (average HAR improvement 0.55). The choice of values therefore is likely to be favourable to the cost-effectiveness of bDMARDs in the base case.

The methods used by the Assessment Group differ from those used by the majority of the manufacturers, which assume that the relationship between HAQ and ACR response observed within their key trials is applicable to all interventions. These assumptions use a relatively small sample size and may be subject to variability, as observed in the two MSD submissions where the assumed HAQ changes per ACR level are markedly different. Additionally, the patients recruited to RCTs may not be representative of those patients who will be treated: this could influence the relation between the absolute change in HAQ and HAQ at baseline.

**TABLE 167** Mean HAQ change by EULAR response category for those on cDMARDs

	HAQ					
	Mean	SE	z-value	p-value	LCL	UCL
<b><i>EULAR response baseline &gt; 6-month visits</i></b>						
None	-0.050	0.025	-2.03	0.043	-0.098	-0.002
Moderate	-0.509	0.035	-14.67	0.000	-0.577	-0.441
Good	-0.650	0.043	-15.10	0.000	-0.735	-0.566
LCL, lower 95% CI; UCL, upper 95% CI.						

### Health Assessment Questionnaire trajectory following initial response

This section has been divided into two subsections: one relating to bDMARDs and one relating to cDMARDs.

In addition to the values assumed by the Assessment Group in our base case, sensitivity analyses were run using values considered within previous NICE TAs. These assumed that the HAQ trajectory on biologics is flat, 0.045 per annum while on cDMARDs and 0.06 per annum while on 'palliative care' (which equated to NBT in the Assessment Group model).

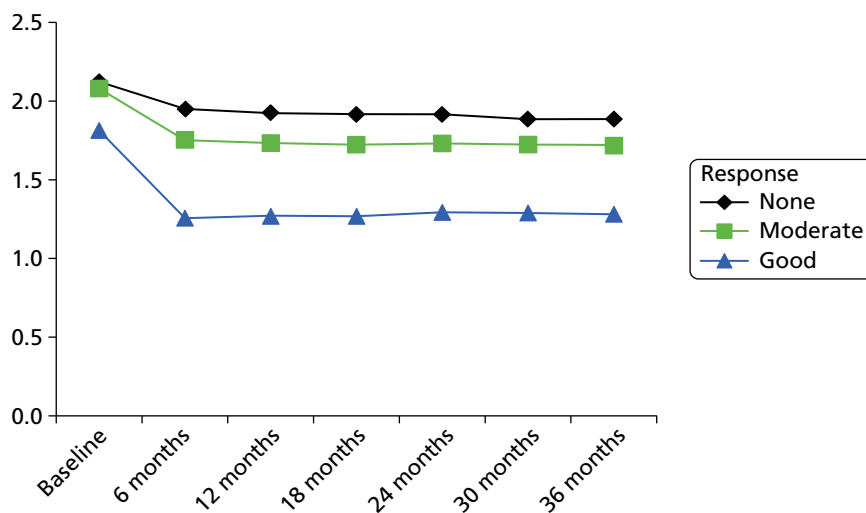
#### bDMARDs

The BSRBR database was used in order to estimate the trajectory of HAQ. The BSRBR database measures HAQ at 6-month intervals for all registered patients for a maximum of 3 years. The evolution of HAQ while a patient remains on a biologic therapy was estimated as a function of a patient's baseline characteristics and 6-month EULAR response category.

The patient data were restricted to those patients who had a full set of baseline characteristics, including HAQ and at least two other recorded measurements of HAQ while on a biologic therapy. The only bDMARDs for which there was sufficient follow-up time were deemed to be ETN, IFX and ADA.

There are 10,186 such patients in the data set, of whom 2417 are EULAR good responders, 5492 are EULAR moderate responders and 2277 are EULAR non-responders (of whom a quarter had treatment longer than 4 years' duration). *Figure 110* shows the average HAQ in the sample by EULAR response. It is seen that HAQ decreases in the first 6 months after starting on a biologic therapy (with the level of decrease greater as the level of EULAR response increases) and levels off towards the end of the 3-years observation period. For good responders there is a degree of loss of initial 6-month HAQ improvement in subsequent periods. It is important to note that there is an imbalance between the three groups of responders. For example, it can be seen that 'good' EULAR responders have a lower baseline HAQ than 'moderate' or non-responders.

Statistical analyses have been undertaken for those patients who have a good or moderate EULAR response. No formal analysis was conducted for those patients who had no EULAR response as they are assumed to have treatment stopped after 6 months in accordance with NICE guidance within the cost-effectiveness analyses.



**FIGURE 110** Mean HAQ by EULAR response category for those receiving bDMARDs.

An 'autoregressive latent trajectory model'<sup>296</sup> was fitted separately for moderate and good responders. The model uses baseline characteristics, including baseline HAQ, to estimate both initial HAQ response (6 months) and the longer-term progression of HAQ in a single statistical model. The model incorporates a random intercept and a random slope from a growth model that captures the fixed and random effects of the latent growth trajectories over time. It also includes an autoregressive structure representing any time-specific influences between the repeated measures of HAQ over time. The model can be written as follows:

$$\begin{aligned} y_{it} &= \eta_{0i} + \eta_{1i}x_t + \rho_t y_{it-1} + \varepsilon_{it} & t = 1, \dots, 6 \\ y_{i0} &= \gamma_0 + w_i' \gamma_1 + \varepsilon_{i0} \\ \eta_{0i} &= \alpha_0 + w_i' \beta_0 + u_{0i} \\ \eta_{1i} &= \alpha_1 + w_i' \beta_1 + u_{1i}, \end{aligned} \tag{24}$$

where  $y_{it}$  denotes HAQ for patient  $i$  at time  $t$  for  $t = 1, \dots, 6$  (where  $t = 1$  corresponds to 6 months after starting biologic,  $t = 2$  corresponds to 12 months after, etc.);  $\eta_{0i}$  and  $\eta_{1i}$  are a random intercept and a random slope respectively;  $w_i$  is a time invariant, individual specific vector of baseline covariates;  $x_t$  are the time scores of a non-linear trend where, for identification purposes, we set the first one to zero ( $x_1 = 0$ ) and the last one, 30 months later, to 3 ( $x_6 = 3$ ) and freely estimate the remaining time scores ( $x_2, \dots, x_5$ ). If a linear trend can appropriately describe the data the estimated time scores should follow the sequence 0.6, 1.2, 1.8, 2.4 for successive periods  $t = 2, \dots, 5$ . The  $\varepsilon_{it}$  are mean zero normal disturbances with time varying variances equal to  $\sigma_{\varepsilon t}^2$ , they are independent over time and uncorrelated with the  $u_i$ 's. The  $u_i$ 's are mean zero, normally distributed, time invariant individual random terms with a full covariance matrix and potentially correlated with  $\varepsilon_{i0}$ . The parameters  $\gamma_0, \alpha_0, \alpha_1$  and the vectors of parameters  $\gamma_1, \beta_0, \beta_1$  are fixed over time whereas  $\rho_t$  is a time-varying parameter.

Health Assessment Questionnaire at baseline is treated as predetermined. Baseline covariates,  $w_i$ , include age; sex; disease duration (in months); DAS28; and number of previous DMARDs. The continuous baseline covariates are centred on their overall sample means (*Table 168*). In addition, the covariate age is divided by 10 in the model to avoid convergence problems due to scaling differences. This is for ease of interpretation of the estimated parameters but does not change the model in any way.

We estimate the model using maximum likelihood with robust SEs using a sandwich estimator to guard against non-normality. Initially a joint model for the three groups (good EULAR response, moderate EULAR response and no EULAR response) was estimated to try to maximise informative data. However, it was found that no restrictions across groups could be imposed and thus the final models had to be estimated conditional on EULAR response to therapy at 6 months. *Table 169* shows the estimated parameters of the models for moderate and good responders.

The autoregressive latent trajectory model fits better than either the autoregressive model or the growth model on its own. Restrictions are tested using the Satorra and Bentler<sup>297</sup> scaled difference chi-squared test.

**TABLE 168** Sample means of baseline covariates

Covariate	All sample (sample mean $n = 10,186$ )	Moderate responders (sample mean $n = 5492$ )	Good responders (sample mean $n = 2417$ )
Age (years)	56.096	56.854	53.815
Female (%)	0.763	0.781	0.700
Disease duration (months)	159.444	160.188	155.544
DAS	6.551	6.763	6.281
Number of previous DMARDs	3.898	3.937	3.645



TABLE 169 Estimated parameters and SEs in brackets

Covariates		Moderate		Good	
	$X_2$	0.159	(0.397)	1.649	(1.531)
	$X_3$	1.634***	(0.314)	2.515***	(4.395)
	$X_4$	2.732***	(0.351)	3.260***	(12.639)
	$X_5$	3.249***	(0.415)	2.810***	(6.998)
Random intercept ( $\eta_{0i}$ )	Intercept	1.365***	0.05	1.233***	0.112
	(Age – mean age)/10	0.088***	0.008	0.147***	0.014
	Female	0.161***	0.021	0.145***	0.035
	Disease duration (months) – mean disease duration	0.006***	0.001	0.013***	0.002
	DAS – mean DAS	0.097***	0.010	0.091***	0.021
	Number of previous DMARDs – mean number of previous DMARDs	0.044***	0.005	0.106***	0.013
Random slope ( $\eta_{1i}$ )	Intercept	0.043	0.03	–0.091**	0.042
	(Age – mean age)/10	0.009***	0.003	–0.009*	0.005
	Female	0.009*	0.006	0.003	0.008
	Disease duration (months) – mean disease duration	0.000	0.000	–0.001***	0.000
	DAS – mean DAS	0.003	0.003	–0.011*	0.006
	Number of previous DMARDs – mean number of previous DMARDs	0.004**	0.002	–0.007*	0.004
HAQ at baseline	Intercept	1.915***	0.015	1.797***	0.023
	(Age – mean age)/10	0.052***	0.006	0.069***	0.010
	Female	0.155***	0.017	0.139***	0.027
	Disease duration (months) – mean disease duration	0.004***	0.001	0.006***	0.001
	DAS – mean DAS	0.179***	0.007	0.158***	0.013
	Number of previous DMARDs – mean number of previous DMARDs	0.033***	0.004	0.076***	0.008
	$\rho_1$	0.111***	0.025	0.007	0.058
	$\rho_2$	0.117***	0.034	0.129**	0.052
	$\rho_3$	0.069***	0.021	0.182***	0.046
	$\rho_4$	0.040	0.033	0.246***	0.055
	$\rho_5$	0.019	0.047	0.216***	0.041
	$\rho_6$	0.026	0.040	0.225***	0.052
	Cov	HAQ0 – $\eta_{0i}$	0.171***	0.008	0.241***
HAQ0 – $\eta_{1i}$		0.005	0.004	–0.018**	0.008
$\eta_{0i}$ – $\eta_{1i}$		0.005	0.006	–0.039**	0.019
Var( $\eta_{0i}$ )		0.259	0.017	0.431	0.067
Var( $\eta_{1i}$ )		0.004	0.001	0.009	0.005

continued

TABLE 169 Estimated parameters and SEs in brackets (*continued*)

Covariates		Moderate		Good	
Var	Eps0	0.245***	(0.006)	0.335***	(0.010)
	Eps1	0.069***	(0.008)	0.039	(0.041)
	Eps2	0.050***	(0.003)	0.074***	(0.011)
	Eps3	0.058***	(0.005)	0.073***	(0.007)
	Eps4	0.044***	(0.004)	0.072***	(0.010)
	Eps5	0.047***	(0.007)	0.060***	(0.008)
	Eps6	0.053***	(0.005)	0.065*	(0.010)

Cov, covariance; var, variance.  
\* $p < 0.1$ ; \*\* $p < 0.05$ ; \*\*\* $p < 0.01$ .

As discussed above, the model provided estimates very close to the observed data in terms of 6-month HAQ changes. The cost-effectiveness model used estimates of the 6-month HAQ change for a patient with mean characteristics of the overall sample, baseline HAQ of 2.03, with all error terms set to zero and conditional on EULAR response category. This resulted in estimates of 0.317 (SE 0.048) for moderate responders and 0.672 (SE 0.112) for good responders.

### cDMARDs

The cost-effectiveness model simulates, for each patient, the progression of HAQ for the period that patient remains on non-biologic DMARDs. This could be (a) for patients on the cDMARD (comparator) element of the simulation model, or (b) for patients on the bDMARD strategy at the point when they withdraw from the biologic therapy.

Previously, Norton *et al.*<sup>292</sup> estimated HAQ progression in patients not receiving bDMARDs using data from patients recruited to the ERAS inception cohort study. This is a large, UK-based cohort that has long-term follow-up. In the Norton *et al.* study,<sup>292</sup> observations relate to patients recruited between 1986 and 1998 ( $n = 1460$ ), followed for up to 10 years. A growth mixture model approach was taken to the analysis of the data. In the published paper, four classes were identified. Full details of the statistical methods are provided in the Norton *et al.* paper,<sup>292</sup> including details of the process for selecting the optimal number of latent classes. These findings have since been corroborated in the NOAR data set with follow-up to 15 years and the Early Rheumatoid Arthritis Network data set.<sup>293</sup> Although the concern in the cost-effectiveness analysis is to estimate the expected change in HAQ over time, not with the latent classes per se, the latent class analysis provides a more flexible and appropriate method of modelling HAQ change over time. It allows the incorporation of patient characteristics as predictors of HAQ progression in a more appropriate manner. Importantly, it also provides a reflection of how the rate of HAQ progression changes over time and places no restriction on this being a simple linear progression. This is likely to be a more appropriate reflection of a chronic disease, the use of different treatments (including drugs and surgical interventions) at different points in the care pathway which influence that progression and the nature of the HAQ scale itself. The use of a simple annual progression rate for all patients at all time points does none of these things.

A modified analysis based on the published Norton *et al.* study<sup>292</sup> was performed so that additional patient descriptors, including those used to define patients within the cost-effectiveness model, were used as covariates within the statistical model. Importantly, these were used as explanatory variables for group membership. In this way, the expected HAQ at any point for a patient with a given set of baseline characteristics can be estimated. The model is formally:

$$y_{itc}^* = \eta_{0ic} + \eta_{1ic}X_t + \eta_{2ic}X_t^2 + \eta_{3ic}X_t^3 + \varepsilon_{it} \quad t = 0, 0.5, 1, 2, \dots, 15$$

$$y_{itc} = \begin{cases} y_{itc}^* & \text{if } y_{itc}^* > 0 \\ 0 & \text{if } y_{itc}^* \leq 0, \end{cases} \quad (25)$$

where  $c$  is the class and the probabilities of class membership are estimated using a multinomial logit model:

$$\Pr(C_{it} = c | z_{it}) = \frac{e^{z_{it}\mu_c}}{\sum_{s=1}^4 e^{z_{it}\mu_s}}, \quad (26)$$

where  $z$  contains a series of factors as covariates within the model that were originally considered in separate analyses in Norton *et al.*<sup>298</sup> plus additional factors relevant to our decision model. Specifically, the model used for the analysis in this report includes age at disease onset; sex; deprivation level; disease duration; rheumatoid factor positive at baseline; fulfilment of ACR criteria for RA at baseline; baseline DAS; failed two DMARDs; and DAS response achieved at 6 months.

The four classes used in the assessment are shown in *Figure 111*. Probabilities in this case relate to the ERAS population as a whole. For the cost-effectiveness populations, covariate adjustment was used to estimate relevant class probabilities.

The plots show that there are clearly identifiable separate groups in terms of HAQ progression. Three classes exhibit a J-shaped curve and the fourth shows a general worsening over time. In all cases, the rate of worsening over time decreases. This is contrary to the typical assumptions of DMARD worsening incorporated into cost-effectiveness models, which are assumed to be linear. The use of the growth model also avoids the prediction that large proportions of patients progress to the worst HAQ state (3) before death. This is contrary to the pattern seen in the ERAS, Early Rheumatoid Arthritis Network and NOAR observational data sets both in and beyond. For example, in the US NDB just 1% of observations exceed a HAQ of 2.5.<sup>299</sup> Although there may be reasons why observational data sets like this do not fully represent patients with such extreme levels of functional disability (e.g. that self-completed surveys are not returned), it is unlikely that these are substantially biased.

There are limitations with this approach: ERAS is an inception cohort with follow-up of patients up to 15 years and we therefore cannot be sure what happens beyond that time. Covariates refer to baseline characteristics in the ERAS data set and, while many of these are set, this baseline does not match all the uses of the data in the cost-effectiveness analysis. It should be noted, however, that many of the limitations that are pertinent to the ERAS analysis are similarly applicable, often to a greater degree, in the studies that underpin the mean HAQ progression rates that are typically used in cost-effectiveness analyses of drug therapies in RA.

**FIGURE 111** Academic-in-confidence information has been removed.

To implement the results of the statistical model in the cost-effectiveness analysis, a number of choices were made:

1. Rather than use the model predictions for absolute HAQ values, we used the model to predict change in HAQ. This ensured consistency with the baseline sampled HAQ value, the degree of improvement modelled at 6 months based on the EULAR response seen in clinical trials and the simulated HAQ scores for patients treated with bDMARDs.
2. The output provided to us [from the software package Mplus version 7 (Muthén & Muthén, Los Angeles, CA, USA)] reports parameter estimates to three decimal places. This is not sufficient and results in some very large fluctuations in the predicted HAQ, particularly at times exceeding 10 years from the start of treatment (this is because there is a cubic term in the model that requires a much greater degree of precision). Instead we used the values for each class reported in *Figure 111*. The model for this analysis differs from that underpinning *Figure 111* only in that there are more variables entering as explanatory variables for class membership. The trajectories within the four classes are unaffected.
3. Not all explanatory variables that appear in the statistical model are relevant to the way that the cost-effectiveness model defines individuals: deprivation level, rheumatoid factor positive at baseline, fulfilment of ACR criteria for RA. We therefore set deprivation level and RF factor positive at the means for the ERAS cohort (0.49 and 0.73 respectively). We set ACR criteria of RA to 1.
4. The HAQ trajectory for the ERAS cohort includes the initial period where patients with early RA start on cDMARDs and, in many cases, experience improvement in their disease. As this period is modelled separately in the SchARR model we incorporated values from year 2 onwards only, as this is the point where initial treatment benefits appear to have been lost for all latent classes.
5. Where extrapolation was used beyond the period for which data were available (i.e. beyond year 15), we assumed zero HAQ progression, as this is the rate of progression predicted by the statistical model, for all classes. This also ensures that the cost-effectiveness model did not simulate counter intuitive results, whereby HAQ improves for patients on cDMARDs but not for patients on bDMARDs. Additionally, it should be noted that it is at these long extrapolations beyond 10 years where there is evidence that the model may underpredict HAQ worsening, even within the period covered by the data. In ERAS there appears to be continued worsening of HAQ in the observed data, though NOAR does not exhibit this characteristic.
6. For those patients simulated to follow bDMARD therapy who then return to cDMARDs after the sequence of biologic drugs has been exhausted, we again take each class from year 2 of the modelled data. Patient covariates are taken from the current position in the model rather than from baseline characteristics.

Overall, for patients population simulated in the cost-effectiveness model for group 2 (those that have failed two previous DMARDs and have active disease), there is a lower probability of being in the lowest class 1 (13% vs. 22% in the overall ERAS cohort), a higher probability of class 2 (36% vs. 33%) and class 3 (38% vs. 29%), and a lower probability of being in class 4 (12% vs. 16%). Thus, the cohort of patients simulated within the cost-effectiveness analysis are concentrated more in the latent classes that exhibit rapid HAQ progression than in the overall ERAS cohort.

The methods used by the Assessment Group differ from those used by the manufacturers, which typically assume within their base cases that HAQ progression on bDMARDs is zero and that HAQ progression on cDMARDs is at the rate of 0.045 per annum.

As seen in *Figure 110*, the assumption that there is no HAQ progression while on bDMARDs appears, in the short term, to be supported by the 3-year follow-up data from the BSRBR. However, the assumed progression on cDMARDs is not compatible with that seen in *Figure 111*, and lacks face validity as this leads to predictions that most patients reach the ceiling value of HAQ prior to death.

It should also be noted that the use of an annual worsening in HAQ of 0.045 entirely lacks any empirical support. Chen *et al.*<sup>123</sup> are the source of this value; they state:

*In the base case, the following assumptions were made concerning HAQ increases over time. It was assumed that patients remaining on TNF inhibitors experience a worsening (increase) in HAQ equivalent to the general population. Based on the study by Krishnan and colleagues, this was set a progression of 0.03 per year. . . It was assumed that TNF inhibitors halve the general worsening in HAQ, so that patients on palliation have a progression rate of 0.06 per year . . . For conventional DMARDs, an intermediate progression rate of 0.045 per year was assumed . . . These assumptions were varied in sensitivity analysis.*

*Chen et al., p.100<sup>123</sup>*

Calculating an accurate HAQ progression can be challenging as historical data on past trends may be only a weak predictor of future trajectories; and there are no data on patients who are inadequately treated. In addition, HAQ alone may not encompass all utility impacts of RA that can be caused by flares.

The Assessment Group identified three papers that provided detail on HAQ trajectory while patients were receiving cDMARDs.<sup>243,300,301</sup> The search was not systematic and it is possible that papers were not identified. Key elements of these trials have been tabulated (*Table 170*). It is also not known whether or not the use of current cDMARDs would be associated with a lower HAQ trajectory.

The clinical advisors within the Assessment Group stated that observational studies of RA populations generally show a HAQ progression substantially < 0.05 per year, but caution that these often cover the spectrum of RA patients and would contain patients who would not have received bDMARDs. This point is highlighted in McWilliams *et al.*<sup>302</sup>

In order to provide an insight into the impact of assumed HAQ trajectory while on cDMARDs the Assessment Group has undertaken scenario analyses using the values of 0.045 for cDMARDs and 0.06 for palliative care in addition to using the models derived from the ERAS database.

There appears to be little long-term evidence to support the value used by the manufacturers; in contrast the values used by the Assessment group have come from a large, prospective, observational database that has been corroborated in a separate database. Assuming a linear HAQ progression does not take into account the impact of surgery that may halt HAQ progression, the costs of which are currently assumed to be incurred without benefit.

### **Time to discontinuation on treatment**

The duration of treatment on the first biologic for adult RA patients was estimated using the BSRBR database, which records the dates on which therapies are initiated and ended. Separate analyses were undertaken for those patients obtaining good and moderate EULAR responses at 6 months. Patients classed as non-responders at 6 months are assumed to be withdrawn from therapy in the Assessment

**TABLE 170** Identified evidence on HAQ progressions while on cDMARDs

Study	Number of patients analysed	cDMARDs	Mean follow-up (years)	Average HAQ progression per annum
Plant <i>et al.</i> , 2005 <sup>300</sup>	421	HCQ, sodium aurothiomalate, auranofin and penicillamine	5	0.08 (from years 1 to 5)
Symmons <i>et al.</i> , 2005 <sup>301</sup>	466	Intensive cDMARD treatment	3	0.06
Munro <i>et al.</i> , 1998 <sup>243</sup>	440	i.m. GLD	5	0.05 (from years 2 to 5)

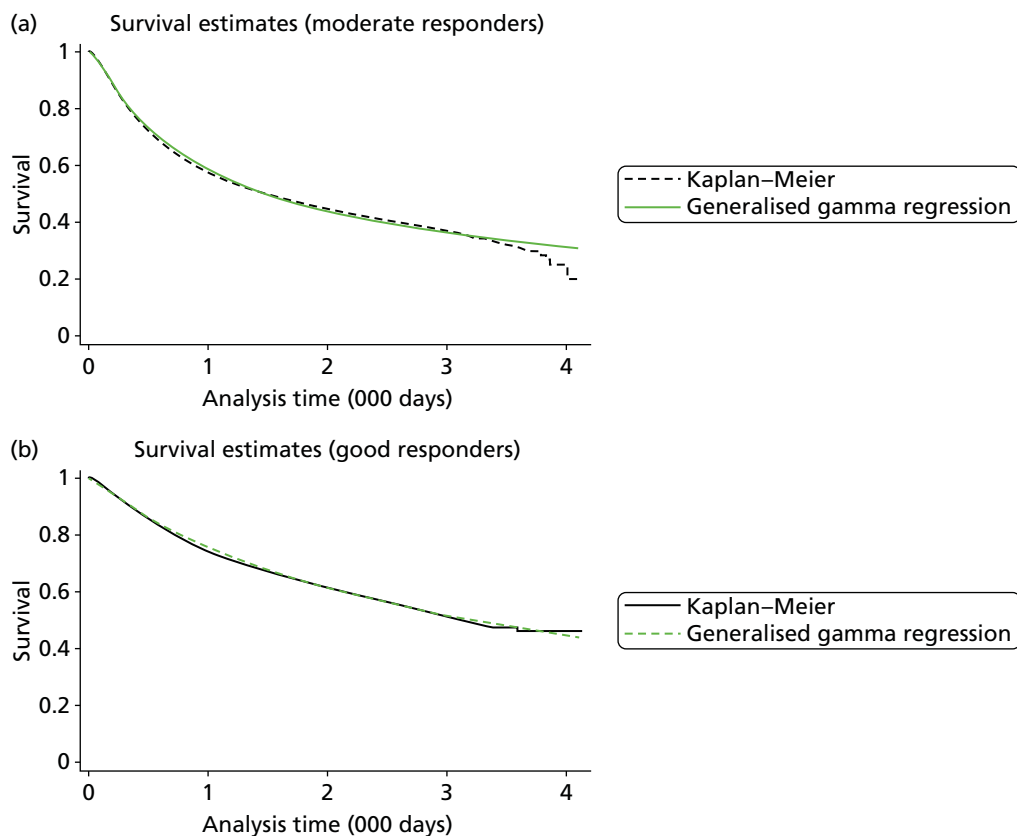
i.m., intramuscular.

Group model (as in current NICE guidance,<sup>22,24,26,27,237</sup> which requires an improvement in DAS28 of at least 1.2 at this time point for treatment to be maintained). This allows patients who have been withdrawn prior to 6 months to be included in the analysis, though there is a risk that their response category recorded at 6 months is in fact related to having switched to some other therapy.

A range of parametric survival models (Weibull, exponential, Gompertz, log-logistic, log-normal, gamma and Weibull frailty models) were considered. The best-fitting model, in terms of both the Akaike information criterion and the Bayesian information criterion, was that based on the gamma distribution. The following covariates were included: age, sex, disease duration at baseline, DAS; number of previous DMARDs and HAQ at baseline. We included all covariates, even if insignificant, but considered alternative specifications (such as squared and log-terms) in order to identify our preferred model, guided by AIC/BIC.

Establishing separate covariates for the individual biologic therapies within this appraisal was considered. As GOL, ABT, TCZ and CTZ comprised < 1% of the observations, and had follow-up durations of much shorter duration, these were excluded leaving only IFX, ETN and ADA. Although the duration of treatment for those on ETN and ADA was significantly shorter than for IFX, this is likely to be due to the times at which therapies became available in the UK. Owing to this potential confounding and the lack of data for a number of treatments, separate terms for individual therapies in the cost-effectiveness analysis were not adopted.

Two plots comparing the duration on treatment estimated by the models with those observed in the BSRBR database are shown in *Figure 112*. These are divided into those patients with moderate or good EULAR response, and are constrained to only those patients who would be eligible for biologics under current NICE guidance. Patients who met the NICE criteria were the overwhelming majority and constituted 7250 of the 7743 patients (94%).



**FIGURE 112** Plots of the estimated data from the statistical models compared with the observed data. (a) Moderate responders (NICE eligible); and (b) good responders (NICE eligible).

Given the paucity of data on bDMARDs used before cDMARDs an assumption was required regarding the duration of treatment if bDMARDs were used before cDMARDs. It was assumed that the duration would be unaffected by whether or not cDMARDs were used prior to bDMARDs.

There were also few data on the duration of response for patients receiving cDMARDs. Based on the assumption that cDMARDs are not likely to be more toxic than biologics used in combination with a cDMARD, it was assumed that the survival duration for each EULAR response category for bDMARDs would be applicable for cDMARDs.

It was assumed that patients would not switch to a subsequent treatment within 6 months of initiating a treatment; this assumes that any AE would be monitored before changing treatment at 6 months.

The method used by the Assessment Group differs from those of the manufacturers but it is commented that there was diversity in the methods used by the manufacturers with no clear consensus reached. One flaw in the approach taken by manufacturers is that the discontinuation rates had frequently not been conditional on EULAR response and thus the average time on treatment would be decreased by those patients without a response who typically stay on treatment for 1 year, despite the current NICE stopping criteria.

In summary, the Assessment Group does not believe any of the methods assumed by the manufacturers represents a significantly better method than that used by the Assessment Group and there is a reason to believe that the approach taken by the Assessment Group is the preferred method.

### **Rebound post treatment**

The change in a patient's HAQ when treatment has failed to be efficacious or is stopped owing to an AE is not known with certainty. The Assessment Group has assumed that following cessation of treatment the initial HAQ improvement experienced on treatment initiation would be lost. The resultant HAQ would be assumed for the subsequent 6 months when the next treatment in the sequence is trialled.

This is similar to assumptions made within the manufacturers' models.

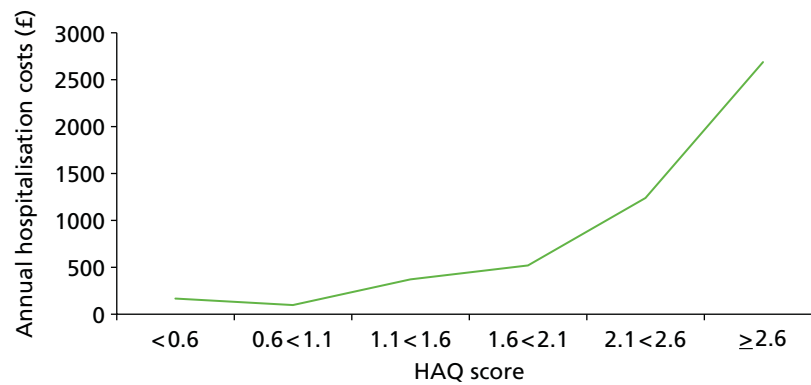
### **Assumed NHS costs per Health Assessment Questionnaire band**

A brief review of the recent literature regarding the costs associated with active RA and in particular HAQ score identified few data that were not identified collectively within the manufacturers' submissions. The only information of note was a poster by Bansback *et al.*<sup>303</sup> which, using Canadian data, concluded that 'the study finds no signal after three years that biologic therapies in patients with RA have led to overall cost offsets from related treatment costs'. Possible explanations that were proffered were falling resource utilisation in general, potentially due to more aggressive use of cDMARDs, have given a false impression that biologics are causally associated with resource utilisation; that cost offsets occur beyond 3 years; and that the model is mis-specified and estimates remain biased.

Although these results are noted the Assessment Group believes it is plausible that there could be an increase in hospitalisation costs as HAQ increases. Having reviewed the hospital costs within the manufacturers' submissions the Assessment Group decided to use that reported by AbbVie for the base case, which were among the lowest of those presented and were relatively flat until the patient had severe HAQ scores (defined as HAQ scores of  $\geq 2.125$ ). These values were derived from data taken from the NOAR database on impatient days and joint replacements<sup>260,261</sup> and were multiplied by NHS reference costs. The values assumed in the Assessment Group base case are depicted in *Figure 113*.

### **Utility related to Health Assessment Questionnaire**

The NICE methods guide states that mapping is an acceptable method for estimating EQ-5D from clinical outcome measures in the absence of direct evidence, but that the statistical properties of the model 'should be fully described, its choice justified, and it should be adequately demonstrated how well the



**FIGURE 113** The assumed relationship between annual hospitalisation costs and HAQ score in the Assessment Group model.

function fits the data' (pp. 39–40).<sup>227</sup> UCB Pharma (CTZ) provided data on the changes in EQ-5D in the initial 6-month period but these were marked AiC.

Hernandez-Alava *et al.*<sup>299,304</sup> report the results of fitting a bespoke mixture model to data from patients with RA from a US observational database comprising in excess of 100,000 observations. Full details of the data set, the statistical model and its performance (in comparative and absolute terms) are provided in the manuscripts.

The set of models reported include HAQ, HAQ<sup>2</sup>, pain, age, age<sup>2</sup> and sex as explanatory variables. These were included because models performed substantially better when they are included. Most previous analyses have excluded pain. However, a substantially better estimate of EQ-5D is obtained by the inclusion of pain alongside HAQ than via HAQ alone. This is to be expected, as the domains covered by the HAQ instrument are very similar to the domains of usual activities, mobility and self-care in the EQ-5D. The dimension of 'pain' attracts the highest weights in the EQ-5D UK scoring regression. The fact that pain enters as a separate covariate in the Hernandez-Alava *et al.*<sup>299,304</sup> model is because HAQ and pain are not perfectly correlated. It is therefore important to include pain as an explanatory variable in estimating EQ-5D.

This does not mean that the cost-effectiveness model needs to be both HAQ and pain based, or that separate HAQ and pain treatment effects need to be estimated for therapies. There are alternative methods by which the relationship between HAQ and pain can be incorporated in to the cost-effectiveness model without the requirement for additional complexity, rather than reverting to poorer methods of explaining EQ-5D.

The Assessment Group uses a two-step process for estimating EQ-5D values from HAQ values: the first step simulates the expected pain score associated with HAQ; the second step estimates EQ-5D based on both HAQ value and pain score.

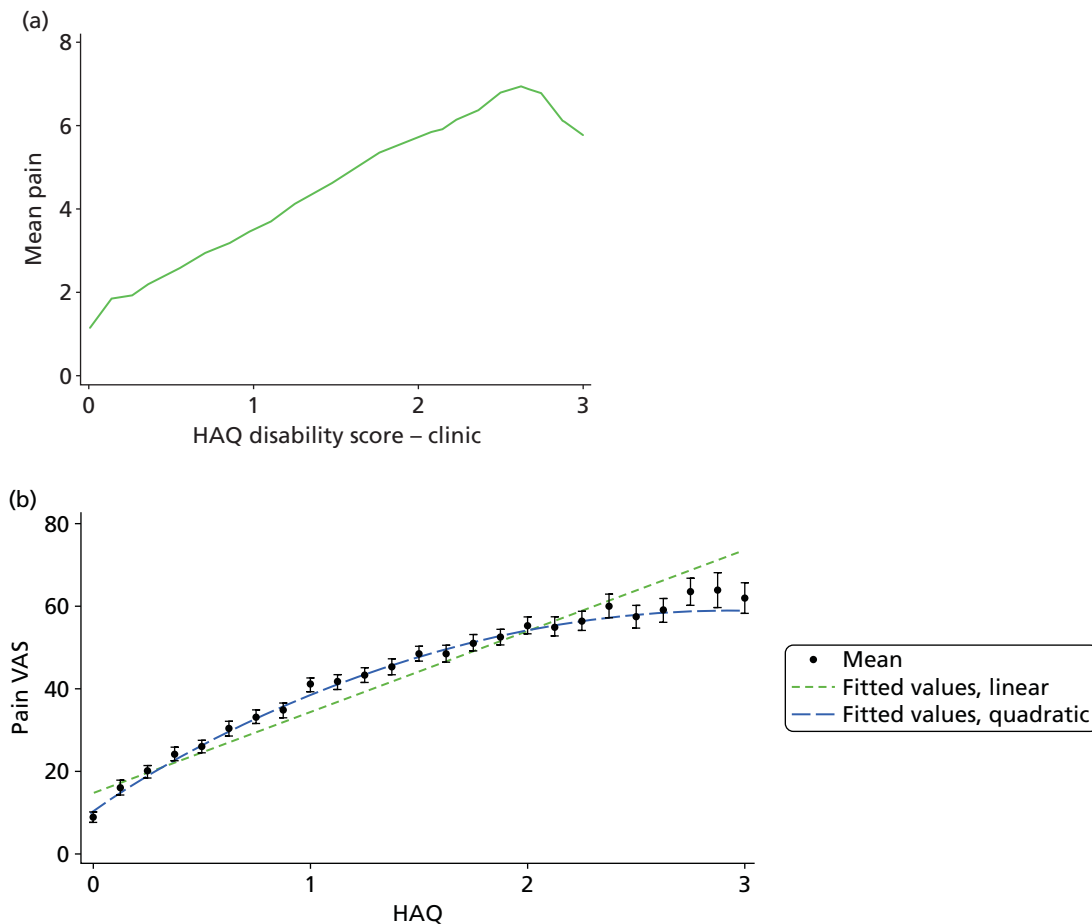
### **Step 1: simulating the expected pain score associated with Health Assessment Questionnaire**

The estimation of EQ-5D utility scores is substantially more accurate when based on HAQ and pain than on HAQ alone as detailed in Hernandez-Alava *et al.*<sup>276</sup> In order to incorporate the published statistical models that estimate this relationship, pain is independently predicted from the simulated HAQ score for each patient within the model. Although this assumes that all treatments affect pain proportionate to their effect on HAQ score, this is also the assumption implicit in all models that exclude pain.

Health Assessment Questionnaire and pain are not related in a simple linear fashion as shown in data from the NDB and data from ERAS (*Figure 114*), which incorporate 100,398 observations for the NDB and 13,357 from ERAS.

Data from the NDB are used to populate the mathematical model, with the mean pain score (and its variance) being estimated for each feasible HAQ score.





**FIGURE 114** The relationship between HAQ score and pain value. (a) NDB; and (b) ERAS.

### Step 2: estimating European Quality of Life-5 Dimensions based on both Health Assessment Questionnaire value and pain scores

It is well recognised that simple linear regression models are inappropriate for estimating EQ-5D values as a function of clinical outcomes. This is because the assumption of conditional normality does not hold for an outcomes measure that is limited above by full health (1), at the worst health state ( $-0.594$ ) and that is typically bi- or tri-modal within this range. This theoretical assertion is supported by empirical findings across a broad range of disease areas<sup>305</sup> and within RA from two separate large data sets that span the full spectrum of disease.<sup>276,299</sup> Linear models lead to biased estimates of EQ-5D. They estimate higher EQ-5D scores for patients in severe health states and lower EQ-5D scores for those patients in less severe health states. The net effect is an undervaluation of the cost-effectiveness of effective therapies. This has been shown to be of a substantial magnitude in RA with ICERs varying by up to 20%.<sup>299</sup>

In this report an alternative method is undertaken, based on mixture models that use an underlying distribution that is bespoke to the EQ-5D UK instrument. This has been reported in Hernandez-Alava *et al.*<sup>299</sup> The model was estimated using data from the US NDB. A total of 103,867 observations were included in the total data set from 16,011 patients. The size of the data set dwarfs that which is typical of most 'mapping' studies and provides a good exemplar in which to test competing methods because patients spanned the full range of HAQ, pain and EQ-5D values.

The preferred model comprised four components, each of which includes HAQ and HAQ<sup>2</sup>, pain, age and age<sup>2</sup> as explanatory variables. HAQ, pain and pain<sup>2</sup> enter the model as predictors of component membership. The model fits substantially better than linear regression or response mapping approaches, does not generate non-feasible values or suffer from systematic bias in the estimates. Full coefficient values are reported in the associated publications. We used the full covariance matrix to incorporate parameter uncertainty into the cost-effectiveness model when running PSAs. These data can be obtained online (<http://rheumatology.oxfordjournals.org/content/suppl/2013/01/20/kes400.DC1> – accessed July 2013<sup>304</sup>).

The Assessment Group believes that its method is more appropriate than those used by the manufacturers. All of the studies used in the base-case manufacturers' submissions are based on linear regression models with insufficient information on which to judge the appropriateness of the statistical models being used and with far fewer patients than used to derive the relationship between HAQ, pain and utility used by the Assessment Group.

The Assessment Group reports that there are further studies that could have been used to inform the manufacturers' submissions that report on the relationship between health utilities, HAQ and other covariates. These are briefly summarised:

- Hawthorne *et al.*<sup>306</sup> used UK EQ-5D data from 139 patients with RA recruited in Australia in a linear regression with HAQ as the only covariate.
- Lindgren *et al.*<sup>284</sup> used Swedish registry data from 1787 patients and used the UK EQ-5D tariff to estimate EQ-5D as a function of HAQ, DAS and age.
- Marra *et al.*<sup>195</sup> report UK tariff EQ-5D as a function of HAQ and age ( $n = 317$ ) from a sample of Canadian patients with RA.
- Kobelt *et al.*<sup>262,264</sup> report mean EQ-5D scores by HAQ category using Swedish registry data ( $n = 116$ ) in the former paper and a combination of Swedish and UK patients in the latter ( $n = 210$ ). For illustrative purposes only, we fitted simple linear models to these reported mean values.

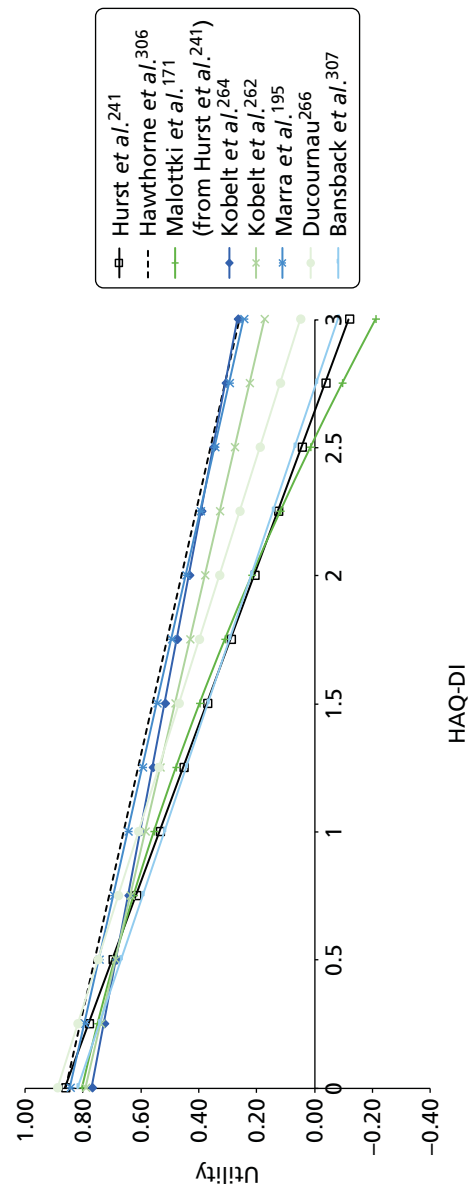
Compared with these studies, the models used as the base case for the entire set of manufacturer submissions<sup>171,241,266,275</sup> have a greater assumed impact on utility than the remaining studies particularly where HAQ exceeds 2, which is the case for a sizeable proportion of cDMARD-treated patients given the assumptions used in many of the cost-effectiveness models regarding HAQ progression over time while on cDMARDs (*Figure 115*).

In a sensitivity analysis the equation mapping HAQ to utility described in Malottki *et al.*<sup>171</sup> was used. Additionally, using the relationship between HAQ and pain taken from the ERAS rather than that from the NDB was evaluated.

### **The assumed costs and disutilities associated with adverse events**

The Assessment Group took a simplistic view regarding AEs.

It was assumed that only serious infections would carry a significant cost and disutility burden and limited the AEs within the model to serious infections alone. A review of the adverse effects of biologics<sup>165</sup> indicated that serious infections were observed in 35 per 1000 patients (95% CI 27 to 46). Singh *et al.*<sup>281</sup> reported the rate of serious infections in people on cDMARDs to be 26 per 1000 patients (no CI reported), implying that an additional 9 per 1000 patients would sustain a serious infection when using a bDMARD. It was assumed that the rate of serious infection was independent of the bDMARDs used. The Assessment Group accepted arguments presented as AiC by UCB Pharma (the manufacturer of CTZ) that there were different exposure durations between CTZ and PBO in the CTZ RCTs and that the increased risk of serious infections reported by Singh *et al.*<sup>281</sup> for CTZ should be treated with caution.



**FIGURE 115** A comparison of published relationships between utility and HAQ.

The costs (£1479 per episode) and undiscounted QALY loss associated with serious infections (a loss in utility of 0.156 for 28 days) were both taken from the Pfizer submission.<sup>209</sup> Based on the assumed increased rate of serious infection it was assumed that a bDMARD strategy would incur an additional £13.31 and a QALY loss of 0.0001 per typical patient treated. These values were increased 100-fold in sensitivity analyses to assess the impact of events that may be too infrequent to be observed in RCTs, but may become apparent when large numbers of patients are treated.

The majority of submissions excluded AEs from the model, although Pfizer included both costs and disutility in a sensitivity analysis and AbbVie included costs alone within the base case.

### **Mortality associated with rheumatoid arthritis**

The link between RA and early mortality has been long documented with a seminal paper being that of Wolfe *et al.*<sup>282</sup> published in 1994. A meta-analysis by Naz and Symmons<sup>5</sup> incorporating 15 studies involving > 300 subjects and published between 1993 and 2006 indicated a range in the standardised mortality ratio of between 1.01 and 2.70. Dadoun *et al.*<sup>6</sup> undertook a meta-analysis of studies reporting mortality rates in RA and reported a meta- standardised mortality ratio of 1.47 (95% CI 1.19 to 1.83) from eight studies although the level of heterogeneity was high with an *I*<sup>2</sup> statistic of 93.47.

However, few data have been published on the relationship between change in HAQ and change in expected mortality, which is the key relationship that is required if there is to be proof that an increase in HAQ score is associated with an increase in mortality. Following a literature review, a paper by Michaud *et al.*<sup>308</sup> published in 2012 was identified that aimed to establish the relationship between change in HAQ and mortality. Their conclusions were that 'changes in the PCS [SF36 physical component summary score] and HAQ did not contribute substantially to predictive value over and above the baseline values of these variables'. As such, the Assessment Group assumed that only the baseline HAQ score was important for predicting mortality and the HRs detailed in *Table 171* were applied. It is noted that as initial HAQ increases then the HRs also increases. It was assumed that these HRs were independent of time.

The CIs for each HAQ category overlap with the neighbouring category. In order to preserve monotonicity for the HRs, quantile matching was assumed when drawing the HR for each category for each PSA iteration. The patient was assumed to die mid-way through their final year.

The Assessment Group method straddles those of the manufacturers in that it applies a fixed HR for mortality but selects this HR based on the initial HAQ category of the patient, with those with a worse HAQ dying sooner on average. This contrasts with the methods used of applying a non-HAQ-related HR, and allowing mortality to be determined by current HAQ score. The Assessment Group comments that the data source used to determine their method is much more recent than those used by the manufacturers.

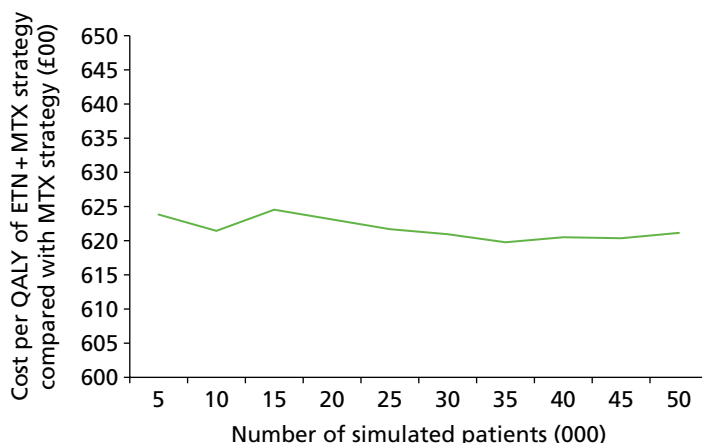
**TABLE 171** Hazard ratio for mortality associated with HAQ category

Initial HAQ category	HR (95% CI)
0.000	1 referent
0.125–0.375	1.4 (1.1 to 1.8)
0.500–0.875	1.5 (1.2 to 1.9)
1.000–1.375	1.8 (1.4 to 2.2)
1.500–1.875	2.7 (2.2 to 3.5)
2.000–2.375	4.0 (3.1 to 5.2)
2.500–3.000	5.5 (3.9 to 7.7)

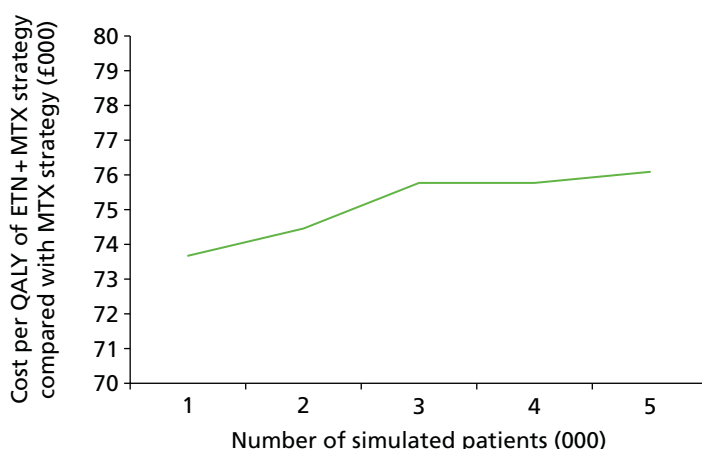
### Calculation of the appropriate number of patients to run when generating results

Analyses were undertaken to assess the number of patients required to be simulated in order that stable results were produced; although these analyses were conducted on an earlier version of the model, it is believed the conclusions in terms of number of patients required are generalisable. The strategies compared were strategies 1 and 6 in *Table 159*, which started with MTX, and ETN and MTX respectively. It was demonstrated (*Figure 116*) that beyond 20,000 simulated patients the change in cost per QALY was small, being < £500 from a base of approximately £62,000. Therefore, 20,000 patients were simulated for all analyses involving patients with severe RA who could receive MTX. It is commented that the cost per QALY between active interventions is likely to require greater numbers of patients for stability, but running greater numbers of patients was not possible within the time constraints of the project.

For patients with moderate RA the computational time required was significantly greater as patients were resampled until the DAS criterion of between 3.1 and 5.2 was met, meaning that large numbers of simulated patients were discarded. This led to the results for this group to be taken from 2000 patients. As such, only 2000 patients were simulated and it is unclear whether or not a stable cost per QALY had been reached (*Figure 117*): the potential error, however, was not deemed to be excessive and appeared to be between £1000 and £2000 on the cost per QALY value.



**FIGURE 116** Evaluating the number of patients required in analyses involving patients with severe RA who could receive MTX.



**FIGURE 117** Evaluating the number of patients required in analyses involving patients with moderate RA who could receive MTX.

For a cDMARD-naive population with severe RA, 20,000 patients were run, at which value the results had appeared to stabilise (see *Figure 117*).

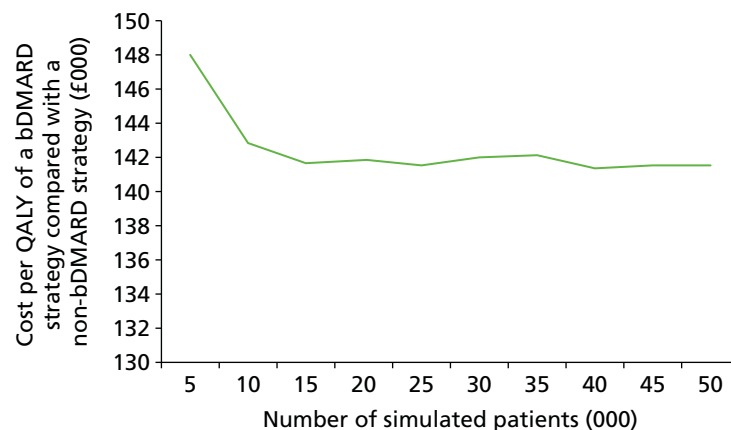
For the population who had severe RA and were bDMARD naive the numbers of patients required to be simulated to generate stable results were investigated (*Figure 118*). Analyses were conducted assuming 20,000 patients at which value the results appeared relatively stable.

The large computational time required meant that the simulated patient numbers were reduced further in the PSA. For severe patients 100 Monte Carlo samples of 2000 patients were conducted and 100 Monte Carlo samples of 200 patients for the moderate group. Although there are fewer patients simulated the expectation of the results are likely to be robust as O'Hagan *et al.*<sup>309</sup> proved that the most efficient method of generating the expectation of cost-effectiveness would be to generate only one patient per PSA iteration. The greater numbers used in our PSA was to facilitate the generation of CEACs.

For both the moderate and the severe RA populations the computational time required for a deterministic analysis was approaching 90 minutes. For the probabilistic analyses the number of simulated patients was reduced by 90% (i.e. 1000 for severe patients and 100 for moderate patients) and 100 probabilistic samples were evaluated, representing approximately 15 hours of computational time.

### Results

A summary of the analyses undertaken is provided in *Table 172*. These are all 24 combinations of factors shown excluding those combining EULAR response in MTX-naive patients as the only data available were for an intervention (GOL) unlicensed in this population. Each analysis had further sensitivity analyses conducted assessing the impact of using a different RCT evidence base, a different mapping of HAQ to utility, an increase in the effects of serious AEs and a different assumed relationship between HAQ and pain.



**FIGURE 118** Discounted cost per QALY of a bDMARD strategy compared with a non-bDMARD strategy in a cDMARD-naive population.

**TABLE 172** Combinations of factors analysed in the cost-effectiveness analyses

Population	Treatment provided	Response measure	HAQ trajectory on cDMARDs
Population 3 (severe MTX experienced)	In combination with MTX	EULAR	Taken from the ERAS database
Population 2 (moderate to severe MTX experienced)	As monotherapy	ACR (then mapped to EULAR)	Using previous NICE appraisal values
Population 1 (severe MTX naive)			

Owing to the number of results presented, the Assessment Group decided that a summary table, providing indicative results, would aid the reader. As will be seen, there is little difference in the estimated cost-effectiveness of the bDMARDs, with the exception of TCZ, which differs as it cannot be used after RTX if it was used as the first bDMARD. As such, the median ICERs for all bDMARDs in populations 2 and 3 are presented in *Tables 173* and *174*. The median was selected as a method of detailing the cost-effectiveness of an average bDMARD. The ICERs for population 1 are provided in *Tables 175* and *176*. No results are presented for a model based on EULAR data for population 1, as there was only one RCT identified that did not include intensive cDMARDs, which are the recommended treatment. The results provided use ACR transformed to EULAR data, but as is seen this approach produced similar cost per QALY results to the models which used EULAR data in populations 2 and 3.

Fully incremental results follow the summary tables. However, these may be misleading when between-bDMARD comparisons are made, as the ICERs compared with the cDMARD-alone strategy are relatively similar, and there is considerable uncertainty in efficacy data. Interventions labelled as dominated may be only slightly more expensive and marginally less effective than a comparator. This cannot be seen in the results as owing to the CiC PASs both discounted costs and discounted QALYs are marked CiC. CEACs are presented; however, CEACs show only the probability of being optimal and inferences regarding relative cost-effectiveness should be made with caution.

### European League Against Rheumatism response measure: Early Rheumatoid Arthritis Study cDMARD Health Assessment Questionnaire progression and a severe, methotrexate-experienced, rheumatoid arthritis population

The base-case results for this population and those from sensitivity analyses are provided in *Tables 177–183*. The CEAC for the base case is shown in *Figure 119*.

It is seen that the ICERs of all the bDMARDs compared with the MTX strategy are in the region of £39,000–43,000.

It is seen that at a willingness to pay of £30,000 the MTX strategy has a very high probability of being optimal (see *Figure 119*).

**TABLE 173** Summarised results: median ICERs for all bDMARD strategies compared with the MTX-alone strategy. Populations 2 and 3 who can receive MTX

Population	Response measure	Assumed HAQ progression	Base case +		No change (£)	RCTs with small percentage of bDMARD prior use, adequate MTX history (£)	RCTs with small percentage of bDMARD prior use (irrespective of MTX history) (£)	Trials with inadequate MTX history (£)	Malottki <i>et al.</i> <sup>171</sup> mapping of HAQ to utility (£)	Discount rates (6% costs, 1.5% QALYs) (£)	Impact of AEs assumed to be 100-fold higher (£)	Relationship between HAQ and pain taken from ERAS (£)	PSA (£)
			RCTs with small percentage of bDMARD prior use, adequate MTX history (£)	RCTs with small percentage of bDMARD prior use (irrespective of MTX history) (£)									
2 (severe MTX experienced)	EULAR	ERAS	61,200	61,400	No data	No data	No data	49,700	39,500	62,200	73,700	61,700	
		Linear	37,900	36,300	No data	No data	No data	32,400	22,300	38,300	46,300	37,600	
	ACR	ERAS	62,200	62,200	62,600	68,900	49,700	39,500	62,200	73,700	62,700		
3 (moderate MTX experienced)	EULAR	ERAS	35,500	35,100	35,700	36,400	30,900	21,400	35,600	43,700	35,900		
		Linear	75,000	74,200	No data	No data	53,400	46,600	78,100	87,300	76,800		
	ACR	ERAS	37,500	36,600	No data	No data	31,300	21,800	39,300	48,300	35,800		
		Linear	77,100	77,500	77,300	79,200	53,900	48,300	79,800	89,300	79,000		
		Linear	38,000	36,700	38,000	39,200	30,000	21,800	39,100	46,700	38,400		

All numbers rounded to the nearest £100.



**TABLE 174** Summary of median ICERs for all bDMARDs compared with an SSZ-alone strategy. Populations 2 and 3 who are treated with monotherapy

Population	Base case +										
	Response measure	Assumed HAQ progression	No change (£)	RCTs with small percentage of bDMARD prior use, adequate MTX history (£)	RCTs with small percentage of bDMARD prior use (irrespective of MTX history) (£)	Trials with inadequate MTX history (£)	Malottki <i>et al.</i> <sup>171</sup> mapping of HAQ to utility (£)	Discount rates (6% costs, 1.5% QALYs) (£)	Impact of AEs assumed to be 100-fold higher (£)	Relationship between HAQ and pain taken from ERAS (£)	PSA (£)
2 (severe MTX experienced)	EULAR	ERAS	87,600	89,000	No data	No data	71,600	58,200	89,100	107,000	88,400
		Linear	39,600	38,000	No data	No data	34,800	24,800	40,200	49,200	39,100
	ACR	ERAS	94,800	93,900	99,600	94,700	79,000	64,700	97,200	117,400	90,000
3 (moderate MTX experienced)	EULAR	ERAS	104,800	108,100	No data	No data	74,400	65,100	108,700	121,900	105,400
		Linear	41,400	39,300	No data	No data	32,800	23,900	41,600	49,700	41,700
	ACR	ERAS	106,400	107,900	110,500	107,900	77,200	70,000	105,900	120,300	108,200
	Linear	38,800	38,500	38,000	37,200	31,100	23,800	40,500	47,100	39,600	

All numbers rounded to the nearest £100.

**TABLE 175** Summarised results: median ICERs for all bDMARD strategies compared with the MTX-alone strategy. Population 1 who can receive MTX

Population	Base case +								
	Response measure	Assumed HAQ progression	No change (£)	RCTs with small percentage of bDMARD prior use (irrespective of MTX history) (£)	Malottki <i>et al.</i> <sup>171</sup> mapping of HAQ to utility (£)	Discount rates (6% costs, 1.5% QALYs) (£)	Impact of AEs assumed to be 100-fold higher (£)	Relationship between HAQ and pain taken from ERAS (£)	PSA (£)
Population 1 (severe MTX naive)	ACR mapped to EULAR	ERAS	308,700	571,700	214,800	185,000	326,100	344,800	295,700
	Linear	Linear	296,300	432,800	216,400	192,900	323,600	344,700	296,700

All numbers rounded to the nearest £100.

**TABLE 176** Summary of median ICERs for all bDMARDs compared with a SSZ-alone strategy. Population 1 who are treated with monotherapy

Population	Response measure	Assumed HAQ progression	Base case +				Discount rates (6% costs, 1.5% QALYs) (£)	Impact of AEs assumed to be 100-fold higher (£)	Relationship between HAQ and pain taken from ERAS (£)	PSA (£)
			No change (£)	RCTs with small percentage of MTX prior use (£)	Malottki et al. <sup>171</sup> mapping of HAQ to utility (£)	ERAS (£)				
Population 1 (severe MTX naive)	ACR mapped to EULAR	ERAS	414,700	140,400	340,500	295,400	382,000	438,700	404,500	
		Linear	378,000	139,800	357,700	291,200	375,300	460,000	408,800	

All numbers rounded to the nearest £100.

**TABLE 177** Deterministic base-case results using EULAR data directly: ERAS cDMARD HAQ progression and a severe, MTX-experienced, RA population

First intervention in the strategy	Discounted costs	Discounted QALYs	CPQ compared with MTX strategy (£)	Incremental CPQ (£)
MTX	CiC information has been removed	CiC information has been removed	–	–
TCZ + MTX	CiC information has been removed	CiC information has been removed	41,647	Extendedly dominated
ABT i.v. + MTX	CiC information has been removed	CiC information has been removed	39,142	39,142
IFX + MTX	CiC information has been removed	CiC information has been removed	39,884	Dominated
ADA + MTX	CiC information has been removed	CiC information has been removed	41,015	Extendedly dominated
CTZ + MTX	CiC information has been removed	CiC information has been removed	42,194	Dominated
GOL + MTX	CiC information has been removed	CiC information has been removed	42,087	Extendedly dominated
ETN + MTX	CiC information has been removed	CiC information has been removed	42,014	74,290

CPQ, cost per QALY gained.

**TABLE 178** Deterministic results having included RCTs with a small proportion of previous bDMARD use (with adequate prior MTX exposure) using EULAR data directly: ERAS cDMARD HAQ progression and a severe, MTX-experienced, RA population

First intervention in the strategy	Discounted costs	Discounted QALYs	CPQ compared with MTX strategy (£)	Incremental CPQ (£)
MTX	CiC information has been removed	CiC information has been removed	–	–
TCZ + MTX	CiC information has been removed	CiC information has been removed	41,194	Extendedly dominated
ABT i.v. + MTX	CiC information has been removed)	CiC information has been removed	38,771	38,771
IFX + MTX	CiC information has been removed	CiC information has been removed	39,246	Dominated
ADA + MTX	CiC information has been removed	CiC information has been removed	41,497	Extendedly dominated
GOL + MTX	CiC information has been removed	CiC information has been removed	41,700	Extendedly dominated
CTZ + MTX	CiC information has been removed	CiC information has been removed	40,467	60,158
ETN + MTX	CiC information has been removed	CiC information has been removed	41,748	Dominated

CPQ, cost per QALY gained.

**TABLE 179** Deterministic results having used the mapping of HAQ to utility from Malottki *et al.*<sup>171</sup> rather than Hernandez-Alava *et al.*<sup>276</sup> using EULAR data directly: ERAS cDMARD HAQ progression and a severe, MTX-experienced, RA population

First intervention in the strategy	Discounted costs	Discounted QALYs	CPQ compared with MTX strategy (£)	Incremental CPQ (£)
MTX	CiC information has been removed	CiC information has been removed	–	–
TCZ + MTX	CiC information has been removed	CiC information has been removed	34,734	Extendedly dominated
ABT i.v. + MTX	CiC information has been removed	CiC information has been removed	32,613	32,613
IFX + MTX	CiC information has been removed	CiC information has been removed	33,193	Dominated
ADA + MTX	CiC information has been removed	CiC information has been removed	34,158	Extendedly dominated
CTZ + MTX	CiC information has been removed	CiC information has been removed	35,234	Dominated
GOL + MTX	CiC information has been removed	CiC information has been removed	34,912	Extendedly dominated
ETN + MTX	CiC information has been removed	CiC information has been removed	34,984	61,719

CPQ, cost per QALY gained.

**TABLE 180** Deterministic results having used discount rates of 6% per annum for costs and 1.5% per annum for QALYs and using EULAR data directly: ERAS cDMARD HAQ progression and a severe, MTX-experienced, RA population

First intervention in the strategy	Discounted costs	Discounted QALYs	CPQ compared with MTX strategy (£)	Incremental CPQ (£)
MTX	CiC information has been removed	CiC information has been removed	–	–
TCZ + MTX	CiC information has been removed	CiC information has been removed	28,495	Extendedly dominated
ABT i.v. + MTX	CiC information has been removed	CiC information has been removed	25,618	25,618
IFX + MTX	CiC information has been removed	CiC information has been removed	26,007	Dominated
CTZ + MTX	CiC information has been removed	CiC information has been removed	26,875	Extendedly dominated
ADA + MTX	CiC information has been removed	CiC information has been removed	27,750	Dominated
GOL + MTX	CiC information has been removed	CiC information has been removed	27,682	Extendedly dominated
ETN + MTX	CiC information has been removed	CiC information has been removed	27,670	50,770

CPQ, cost per QALY gained.

**TABLE 181** Deterministic results assuming 100-fold increased impact of AEs and using EULAR data directly: ERAS cDMARD HAQ progression and a severe, MTX-experienced, RA population

First intervention in the strategy	Discounted costs	Discounted QALYs	CPQ compared with MTX strategy (£)	Incremental CPQ (£)
MTX	CiC information has been removed	CiC information has been removed	–	–
TCZ + MTX	CiC information has been removed	CiC information has been removed	42,426	Extendedly dominated
ABT i.v. + MTX	CiC information has been removed)	CiC information has been removed	40,059	40,059
IFX + MTX	CiC information has been removed	CiC information has been removed	40,490	Dominated
CTZ + MTX	CiC information has been removed	CiC information has been removed	42,797	Extendedly dominated
ADA + MTX	CiC information has been removed	CiC information has been removed	41,756	Extendedly dominated
GOL + MTX	CiC information has been removed	CiC information has been removed	42,759	Dominated
ETN + MTX	CiC information has been removed)	CiC information has been removed	42,719	72,481

CPQ, cost per QALY gained.

**TABLE 182** Deterministic results having used the relationship between HAQ and pain derived from ERAS: ERAS cDMARD HAQ progression and a severe, MTX-experienced, RA population

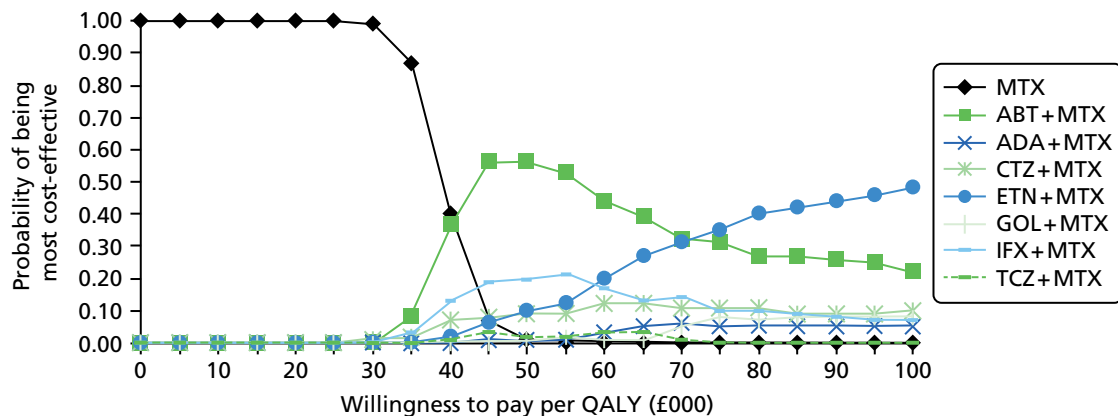
First intervention in the strategy	Discounted costs	Discounted QALYs	CPQ compared with MTX strategy (£)	Incremental CPQ (£)
MTX	CiC information has been removed	CiC information has been removed	–	–
TCZ + MTX	CiC information has been removed	CiC information has been removed	50,985	Extendedly dominated
ABT i.v. + MTX	CiC information has been removed	CiC information has been removed	47,972	47,972
IFX + MTX	CiC information has been removed	CiC information has been removed	48,393	Dominated
ADA + MTX	CiC information has been removed	CiC information has been removed	51,133	Extendedly dominated
CTZ + MTX	CiC information has been removed	CiC information has been removed	49,945	Extendedly dominated
GOL + MTX	CiC information has been removed)	CiC information has been removed	51,058	Extendedly dominated
ETN + MTX	CiC information has been removed	CiC information has been removed	51,019	83,942

CPQ, cost per QALY gained.

**TABLE 183** Probabilistic base-case results using EULAR data directly: ERAS cDMARD HAQ progression and a severe, MTX-experienced, RA population

First intervention in the strategy	Discounted costs	Discounted QALYs	CPQ compared with MTX strategy (£)	Incremental CPQ (£)
MTX	CiC information has been removed	CiC information has been removed	–	–
TCZ + MTX	CiC information has been removed	CiC information has been removed	41,305	Extendedly dominated
ABT i.v. + MTX	CiC information has been removed	CiC information has been removed	38,904	38,904
IFX + MTX	CiC information has been removed	CiC information has been removed	39,376	Dominated
CTZ + MTX	CiC information has been removed	CiC information has been removed	40,505	Extendedly dominated
ADA + MTX	CiC information has been removed	CiC information has been removed	41,710	Dominated
GOL + MTX	CiC information has been removed	CiC information has been removed	41,617	Extendedly dominated
ETN + MTX	CiC information has been removed	CiC information has been removed	41,691	73,145

CPQ, cost per QALY gained.



**FIGURE 119** The CEAC when using EULAR data directly: ERAS cDMARD HAQ progression and a severe, MTX-experienced, RA population.

**European League Against Rheumatism response measure: linear cDMARD Health Assessment Questionnaire progression and a severe, methotrexate-experienced, rheumatism arthritis population**

The base-case results for this population and those from sensitivity analyses are provided in *Tables 184–190*. The CEAC for the base case is shown in *Figure 120*.

It is seen that the ICERs of all the bDMARDs compared with the MTX strategy are in the region of £35,000–40,000.

It is seen that at a willingness to pay of £30,000 per QALY the MTX strategy has a high probability of being optimal.

**TABLE 184** Deterministic base-case results using EULAR data directly: linear cDMARD HAQ progression and a severe, MTX-experienced, RA population

First intervention in the strategy	Discounted costs	Discounted QALYs	CPQ compared with MTX strategy (£)	Incremental CPQ (£)
MTX	CiC information has been removed	CiC information has been removed	–	–
TCZ + MTX	CiC information has been removed	CiC information has been removed	35,872	Extendedly dominated
ABT i.v. + MTX	CiC information has been removed	CiC information has been removed	35,794	34,247
IFX + MTX	CiC information has been removed	CiC information has been removed	36,176	Dominated
ADA + MTX	CiC information has been removed	CiC information has been removed	38,463	Extendedly dominated
CTZ + MTX	CiC information has been removed	CiC information has been removed	37,867	Extendedly dominated
GOL + MTX	CiC information has been removed	CiC information has been removed	38,689	Extendedly dominated
ETN + MTX	CiC information has been removed	CiC information has been removed	39,068	83,446

CPQ, cost per QALY gained.

**TABLE 185** Deterministic results having included RCTs with a small proportion of previous bDMARD use (with adequate prior MTX exposure) using EULAR data directly: linear cDMARD HAQ progression and a severe, MTX-experienced, RA population

First intervention in the strategy	Discounted costs	Discounted QALYs	CPQ compared with MTX strategy (£)	Incremental CPQ (£)
MTX	CiC information has been removed	CiC information has been removed	–	–
TCZ + MTX	CiC information has been removed	CiC information has been removed	33,795	33,795
ABT i.v. + MTX	CiC information has been removed	CiC information has been removed	33,896	35,682
IFX + MTX	CiC information has been removed	CiC information has been removed	34,473	Dominated
ADA + MTX	CiC information has been removed	CiC information has been removed	36,589	Extendedly dominated
GOL + MTX	CiC information has been removed	CiC information has been removed	36,800	Extendedly dominated
CTZ + MTX	CiC information has been removed	CiC information has been removed	36,292	69,464
ETN + MTX	CiC information has been removed	CiC information has been removed	37,377	616,967

CPQ, cost per QALY gained.

**TABLE 186** Deterministic results having used the mapping of HAQ to utility from Malottki *et al.*<sup>171</sup> rather than Hernandez-Alava *et al.*<sup>276</sup> using EULAR data directly: linear cDMARD HAQ progression and a severe, MTX-experienced, RA population

First intervention in the strategy	Discounted costs	Discounted QALYs	CPQ compared with MTX strategy (£)	Incremental CPQ (£)
MTX	CiC information has been removed	CiC information has been removed	–	–
TCZ + MTX	CiC information has been removed	CiC information has been removed	30,635	Extendedly dominated
ABT i.v. + MTX	CiC information has been removed	CiC information has been removed	30,412	30,412
IFX + MTX	CiC information has been removed	CiC information has been removed	31,067	Dominated
ADA + MTX	CiC information has been removed	CiC information has been removed	33,066	Extendedly dominated
CTZ + MTX	CiC information has been removed	CiC information has been removed	32,382	Extendedly dominated
GOL + MTX	CiC information has been removed	CiC information has been removed	33,160	Dominated
ETN + MTX	CiC information has been removed	CiC information has been removed	33,193	67,129

CPQ, cost per QALY gained.

**TABLE 187** Deterministic results having used discount rates of 6% per annum for costs and 1.5% per annum for QALYs and using EULAR data directly: linear cDMARD HAQ progression and a severe, MTX-experienced, RA population

First intervention in the strategy	Discounted costs	Discounted QALYs	CPQ compared with MTX strategy (£)	Incremental CPQ (£)
MTX	CiC information has been removed	CiC information has been removed	–	–
TCZ + MTX	CiC information has been removed	CiC information has been removed	22,212	Extendedly dominated
ABT i.v. + MTX	CiC information has been removed	CiC information has been removed	21,057	21,057
IFX + MTX	CiC information has been removed	CiC information has been removed	21,470	Dominated
CTZ + MTX	CiC information has been removed	CiC information has been removed	22,479	Extendedly dominated
ADA + MTX	CiC information has been removed	CiC information has been removed	22,998	Dominated
GOL + MTX	CiC information has been removed	CiC information has been removed	23,178	Dominated
ETN + MTX	CiC information has been removed	CiC information has been removed	23,476	32,884

CPQ, cost per QALY gained.



**TABLE 188** Deterministic results assuming 100-fold increased impact of AEs and using EULAR data directly: linear cDMARD HAQ progression and a severe, MTX-experienced, RA population

First intervention in the strategy	Discounted costs	Discounted QALYs	CPQ compared with MTX strategy (£)	Incremental CPQ (£)
MTX	CiC information has been removed	CiC information has been removed	–	–
TCZ + MTX	CiC information has been removed	CiC information has been removed	35,890	Extendedly dominated
ABT i.v. + MTX	CiC information has been removed	CiC information has been removed	35,421	35,421
IFX + MTX	CiC information has been removed	CiC information has been removed	36,303	Dominated
ADA + MTX	CiC information has been removed	CiC information has been removed	38,543	Extendedly dominated
CTZ + MTX	CiC information has been removed	CiC information has been removed	37,866	Extendedly dominated
GOL + MTX	CiC information has been removed	CiC information has been removed	38,608	Extendedly dominated
ETN + MTX	CiC information has been removed	CiC information has been removed	39,067	87,843

CPQ, cost per QALY gained.

**TABLE 189** Deterministic results having used the relationship between HAQ and pain derived from ERAS: linear cDMARD HAQ progression and a severe, MTX-experienced, RA population

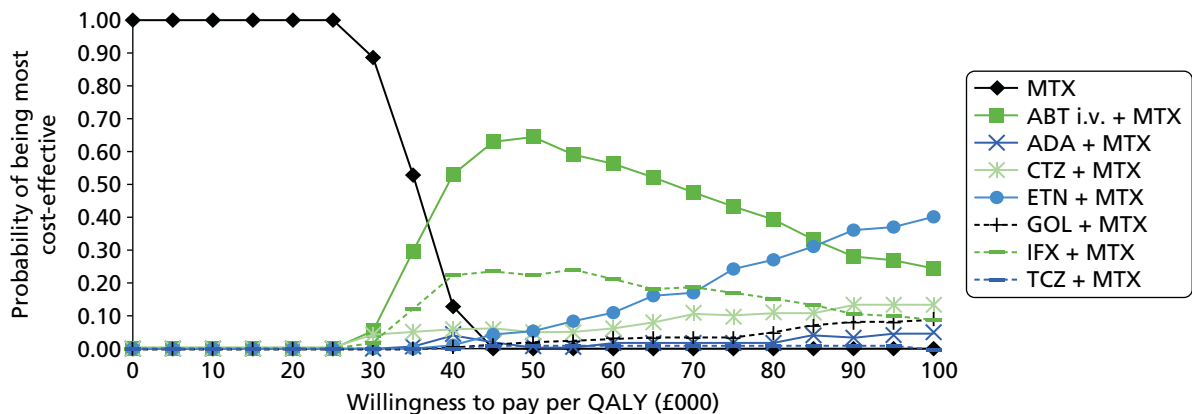
First intervention in the strategy	Discounted costs	Discounted QALYs	CPQ compared with MTX strategy (£)	Incremental CPQ (£)
MTX	CiC information has been removed	CiC information has been removed	–	–
TCZ + MTX	CiC information has been removed	CiC information has been removed	44,112	Extendedly dominated
ABT i.v. + MTX	CiC information has been removed	CiC information has been removed	43,866	43,866
IFX + MTX	CiC information has been removed	CiC information has been removed	44,533	Extendedly dominated
ADA + MTX	CiC information has been removed	CiC information has been removed	47,199	Extendedly dominated
CTZ + MTX	CiC information has been removed	CiC information has been removed	46,305	Extendedly dominated
GOL + MTX	CiC information has been removed	CiC information has been removed	47,439	Extendedly dominated
ETN + MTX	CiC information has been removed	CiC information has been removed	47,830	99,048

CPQ, cost per QALY gained.

**TABLE 190** Probabilistic base-case results using EULAR data directly: linear cDMARD HAQ progression and a severe, MTX-experienced, RA population

First intervention in the strategy	Discounted costs	Discounted QALYs	CPQ compared with MTX strategy (£)	Incremental CPQ (£)
MTX	CiC information has been removed	CiC information has been removed	–	–
TCZ + MTX	CiC information has been removed	CiC information has been removed	38,152	Extendedly dominated
ABT i.v. + MTX	CiC information has been removed	CiC information has been removed	34,843	34,843
IFX + MTX	CiC information has been removed	CiC information has been removed	35,425	Dominated
CTZ + MTX	CiC information has been removed	CiC information has been removed	36,644	Extendedly dominated
ADA + MTX	CiC information has been removed	CiC information has been removed	37,583	Dominated
GOL + MTX	CiC information has been removed	CiC information has been removed	37,779	Extendedly dominated
ETN + MTX	CiC information has been removed	CiC information has been removed	38,355	86,917

CPQ, cost per QALY gained.



**FIGURE 120** The CEAC using EULAR data directly and assuming linear cDMARD HAQ progression.

**American College of Rheumatology response measure: Early Rheumatoid Arthritis Study cDMARD Health Assessment Questionnaire progression and a severe, methotrexate-experienced, rheumatoid arthritis population**

The base-case results for this population and those from sensitivity analyses are provided in Tables 191–199. The CEAC for the base case is shown in Figure 121.

It is seen that the ICERs of all the bDMARDs compared with the MTX strategy are in the region of £38,000–43,000.

It is seen that at a willingness to pay of £30,000 the MTX strategy has a very high probability of being optimal.

**TABLE 191** Deterministic base-case results using ACR data mapped to EULAR data: ERAS cDMARD HAQ progression and a severe, MTX-experienced, RA population

First intervention in the strategy	Discounted costs	Discounted QALYs	CPQ compared with MTX strategy (£)	Incremental CPQ (£)
MTX	CiC information has been removed	CiC information has been removed	–	–
TCZ + MTX	CiC information has been removed	CiC information has been removed	41,453	Extendedly dominated
ABT i.v. + MTX	CiC information has been removed	CiC information has been removed	38,468	38,468
IFX + MTX	CiC information has been removed	CiC information has been removed	38,503	43,937
CTZ + MTX	CiC information has been removed	CiC information has been removed	39,924	Dominated
ABT s.c. + MTX	CiC information has been removed	CiC information has been removed	41,314	Extendedly dominated
GOL + MTX	CiC information has been removed	CiC information has been removed	41,611	Dominated
ADA + MTX	CiC information has been removed	CiC information has been removed	41,567	Dominated
ETN + MTX	CiC information has been removed	CiC information has been removed	42,494	201,284

CPQ, cost per QALY gained.

**TABLE 192** Deterministic results having included RCTs with a small proportion of previous bDMARD use (with adequate prior MTX exposure) using ACR data mapped to EULAR data: ERAS cDMARD HAQ progression and a severe, MTX-experienced, RA population

First intervention in the strategy	Discounted costs	Discounted QALYs	CPQ compared with MTX strategy (£)	Incremental CPQ (£)
MTX	CiC information has been removed	CiC information has been removed	–	–
TCZ + MTX	CiC information has been removed	CiC information has been removed	41,396	Extendedly dominated
ABT i.v. + MTX	CiC information has been removed	CiC information has been removed	38,743	38,743
IFX + MTX	CiC information has been removed	CiC information has been removed	38,844	50,533
ABT s.c. + MTX	CiC information has been removed	CiC information has been removed	41,468	Extendedly dominated
ADA + MTX	CiC information has been removed	CiC information has been removed	41,892	Dominated
GOL + MTX	CiC information has been removed	CiC information has been removed	41,943	Extendedly dominated
CTZ + MTX	CiC information has been removed	CiC information has been removed	41,144	105,558
ETN + MTX	CiC information has been removed	CiC information has been removed	42,894	1,526,573

CPQ, cost per QALY gained.

**TABLE 193** Deterministic results having included RCTs with a small proportion of previous bDMARD use (irrespective of prior MTX exposure) using ACR data mapped to EULAR data: ERAS cDMARD HAQ progression and a severe, MTX-experienced, RA population

First intervention in the strategy	Discounted costs	Discounted QALYs	CPQ compared with MTX strategy (£)	Incremental CPQ (£)
MTX	CiC information has been removed	CiC information has been removed	–	–
TCZ + MTX	CiC information has been removed	CiC information has been removed	40,977	Extendedly dominated
ABT i.v. + MTX	CiC information has been removed	CiC information has been removed	38,171	38,171
IFX + MTX	CiC information has been removed	CiC information has been removed	38,446	Extendedly dominated
ABT s.c. + MTX	CiC information has been removed	CiC information has been removed	40,945	Extendedly dominated
ADA + MTX	CiC information has been removed	CiC information has been removed	41,263	Dominated
GOL + MTX	CiC information has been removed	CiC information has been removed	41,104	Extendedly dominated
CTZ + MTX	CiC information has been removed	CiC information has been removed	40,690	104,017
ETN + MTX	CiC information has been removed	CiC information has been removed	42,404	Dominated

CPQ, cost per QALY gained.

**TABLE 194** Deterministic results having included RCTs with potentially low prior MTX exposure using ACR data mapped to EULAR data: ERAS cDMARD HAQ progression and a severe, MTX-experienced, RA population

First intervention in the strategy	Discounted costs	Discounted QALYs	CPQ compared with MTX strategy (£)	Incremental CPQ (£)
MTX	CiC information has been removed	CiC information has been removed	–	–
TCZ + MTX	CiC information has been removed	CiC information has been removed	42,440	Extendedly dominated
ABT i.v. + MTX	CiC information has been removed	CiC information has been removed	38,774	38,774
IFX + MTX	CiC information has been removed	CiC information has been removed	39,223	150,385
CTZ + MTX	CiC information has been removed	CiC information has been removed	40,750	Dominated
ABT s.c. + MTX	CiC information has been removed	CiC information has been removed	41,827	Extendedly dominated
GOL + MTX	CiC information has been removed	CiC information has been removed	41,879	211,049
ADA + MTX	CiC information has been removed	CiC information has been removed	42,060	Dominated
ETN + MTX	CiC information has been removed	CiC information has been removed	42,857	Dominated

CPQ, cost per QALY gained.

**TABLE 195** Deterministic results having used the mapping of HAQ to utility from Malottki *et al.*<sup>171</sup> rather than Hernandez-Alava *et al.*<sup>276</sup> using ACR data mapped to EULAR data: ERAS cDMARD HAQ progression and a severe, MTX-experienced, RA population

First intervention in the strategy	Discounted costs	Discounted QALYs	CPQ compared with MTX strategy (£)	Incremental CPQ (£)
MTX	CiC information has been removed	CiC information has been removed	–	–
TCZ + MTX	CiC information has been removed	CiC information has been removed	34,810	Extendedly dominated
ABT i.v. + MTX	CiC information has been removed	CiC information has been removed	32,233	32,233
IFX + MTX	CiC information has been removed	CiC information has been removed	32,497	Extendedly dominated
CTZ + MTX	CiC information has been removed	CiC information has been removed	33,681	Dominated
ABT s.c. + MTX	CiC information has been removed	CiC information has been removed	34,606	Extendedly dominated
ADA + MTX	CiC information has been removed	CiC information has been removed	34,976	Dominated
GOL + MTX	CiC information has been removed	CiC information has been removed	34,751	Extendedly dominated
ETN + MTX	CiC information has been removed	CiC information has been removed	35,581	125,993

CPQ, cost per QALY gained.

**TABLE 196** Deterministic results having used discount rates of 6% per annum for costs and 1.5% per annum for QALYs and using ACR data mapped to EULAR data: ERAS cDMARD HAQ progression and a severe, MTX-experienced, RA population

First intervention in the strategy	Discounted costs	Discounted QALYs	CPQ compared with MTX strategy (£)	Incremental CPQ (£)
MTX	CiC information has been removed	CiC information has been removed	–	–
TCZ + MTX	CiC information has been removed	CiC information has been removed	29,441	Extendedly dominated
ABT i.v. + MTX	CiC information has been removed	CiC information has been removed	26,238	26,238
IFX + MTX	CiC information has been removed	CiC information has been removed	26,295	30,514
CTZ + MTX	CiC information has been removed	CiC information has been removed	27,266	Dominated
ABT s.c. + MTX	CiC information has been removed	CiC information has been removed	28,264	Extendedly dominated
GOL + MTX	CiC information has been removed	CiC information has been removed	28,197	Extendedly dominated
ADA + MTX	CiC information has been removed	CiC information has been removed	28,300	Dominated
ETN + MTX	CiC information has been removed	CiC information has been removed	28,947	127,884

CPQ, cost per QALY gained.

**TABLE 197** Deterministic results assuming 100-fold increased impact of AEs and using ACR data mapped to EULAR data: ERAS cDMARD HAQ progression and a severe, MTX-experienced, RA population

First intervention in the strategy	Discounted costs	Discounted QALYs	CPQ compared with MTX strategy (£)	Incremental CPQ (£)
MTX	CiC information has been removed	CiC information has been removed	–	–
TCZ + MTX	CiC information has been removed	CiC information has been removed	42,766	Extendedly dominated
ABT i.v. + MTX	CiC information has been removed	CiC information has been removed	39,148	39,148
IFX + MTX	CiC information has been removed	CiC information has been removed	39,550	88,576
CTZ + MTX	CiC information has been removed	CiC information has been removed	41,482	Dominated
ABT s.c. + MTX	CiC information has been removed	CiC information has been removed	42,350	Extendedly dominated
ADA + MTX	CiC information has been removed	CiC information has been removed	42,441	Dominated
GOL + MTX	CiC information has been removed	CiC information has been removed	42,849	Dominated
ETN + MTX	CiC information has been removed	CiC information has been removed	43,656	223,921

CPQ, cost per QALY gained.

**TABLE 198** Deterministic results having used the relationship between HAQ and pain derived from ERAS: ERAS cDMARD HAQ progression and a severe, MTX-experienced, RA population

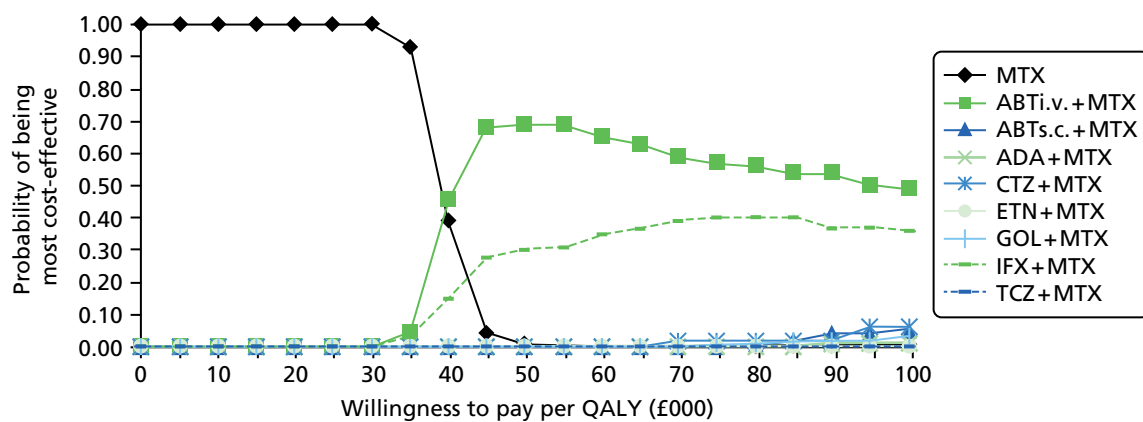
First intervention in the strategy	Discounted costs	Discounted QALYs	CPQ compared with MTX strategy (£)	Incremental CPQ (£)
MTX	CiC information has been removed	CiC information has been removed	–	–
TCZ + MTX	CiC information has been removed	CiC information has been removed	50,025	Extendedly dominated
ABT i.v. + MTX	CiC information has been removed	CiC information has been removed	46,468	46,468
IFX + MTX	CiC information has been removed	CiC information has been removed	47,302	127,526
CTZ + MTX	CiC information has been removed	CiC information has been removed	48,910	Dominated
ABT s.c. + MTX	CiC information has been removed	CiC information has been removed	50,522	Dominated
ADA + MTX	CiC information has been removed	CiC information has been removed	50,490	Extendedly dominated
GOL + MTX	CiC information has been removed	CiC information has been removed	50,581	Extendedly dominated
ETN + MTX	CiC information has been removed	CiC information has been removed	51,744	212,575

CPQ, cost per QALY gained.

**TABLE 199** Probabilistic base-case results using ACR data mapped to EULAR data: ERAS cDMARD HAQ progression and a severe, MTX-experienced, RA population

First intervention in the strategy	Discounted costs	Discounted QALYs	CPQ compared with MTX strategy (£)	Incremental CPQ (£)
MTX	CiC information has been removed	CiC information has been removed	–	–
TCZ + MTX	CiC information has been removed	CiC information has been removed	42,537	Extendedly dominated
ABT i.v. + MTX	CiC information has been removed	CiC information has been removed	39,355	39,355
IFX + MTX	CiC information has been removed	CiC information has been removed	39,803	107,673
CTZ + MTX	CiC information has been removed	CiC information has been removed	41,317	Dominated
ABT s.c. + MTX	CiC information has been removed	CiC information has been removed	42,334	Extendedly dominated
ADA + MTX	CiC information has been removed	CiC information has been removed	42,599	Dominated
GOL + MTX	CiC information has been removed	CiC information has been removed	42,551	Extendedly dominated
ETN + MTX	CiC information has been removed	CiC information has been removed	43,632	187,586

CPQ, cost per QALY gained.

**FIGURE 121** The CEAC when using ACR data mapped to EULAR data: ERAS cDMARD HAQ progression and a severe, MTX-experienced, RA population.

### American College of Rheumatology response measure: linear Health Assessment Questionnaire progression and a severe, methotrexate-experienced, rheumatoid arthritis population

The base-case results for this population and those from sensitivity analyses are provided in *Tables 200–208*. The CEAC for the base case is shown in *Figure 122*.

It is seen that the ICERs of all the bDMARDs compared with the MTX strategy are in the region of £33,000–39,000.

It is seen that at a willingness to pay of £30,000 per QALY the MTX strategy has a relatively high probability of being optimal.

**TABLE 200** Deterministic base-case results using ACR data mapped to EULAR data: linear cDMARD HAQ progression and a severe, MTX-experienced, RA population

First intervention in the strategy	Discounted costs	Discounted QALYs	CPQ compared with MTX strategy (£)	Incremental CPQ (£)
MTX	CiC information has been removed	CiC information has been removed	–	–
TCZ + MTX	CiC information has been removed	CiC information has been removed	33,099	33,099
ABT i.v. + MTX	CiC information has been removed	CiC information has been removed	33,660	38,771
IFX + MTX	CiC information has been removed	CiC information has been removed	34,348	Extendedly dominated
CTZ + MTX	CiC information has been removed	CiC information has been removed	35,518	Dominated
ABT s.c. + MTX	CiC information has been removed	CiC information has been removed	36,794	Extendedly dominated
ADA + MTX	CiC information has been removed	CiC information has been removed	36,878	Dominated
GOL + MTX	CiC information has been removed	CiC information has been removed	36,701	Extendedly dominated
ETN + MTX	CiC information has been removed	CiC information has been removed	38,078	213,466

CPQ, cost per QALY gained.

**TABLE 201** Deterministic results having included RCTs with a small proportion of previous bDMARD use (with adequate prior MTX exposure) using ACR data mapped to EULAR data: linear cDMARD HAQ progression and a severe, MTX-experienced, RA population

First intervention in the strategy	Discounted costs	Discounted QALYs	CPQ compared with MTX strategy (£)	Incremental CPQ (£)
MTX	CiC information has been removed	CiC information has been removed	–	–
TCZ + MTX	CiC information has been removed	CiC information has been removed	31,190	31,190
ABT i.v. + MTX	CiC information has been removed	CiC information has been removed	32,511	43,343
IFX + MTX	CiC information has been removed	CiC information has been removed	32,570	82,908
ADA + MTX	CiC information has been removed	CiC information has been removed	35,233	Dominated
ABT s.c. + MTX	CiC information has been removed	CiC information has been removed	35,142	Extendedly dominated
GOL + MTX	CiC information has been removed	CiC information has been removed	35,470	Extendedly dominated
CTZ + MTX	CiC information has been removed	CiC information has been removed	35,107	132,855
ETN + MTX	CiC information has been removed	CiC information has been removed	36,633	Dominated

CPQ, cost per QALY gained.



**TABLE 202** Deterministic results having included RCTs with a small proportion of previous bDMARD use (irrespective of prior MTX exposure) using ACR data mapped to EULAR data: linear cDMARD HAQ progression and a severe, MTX-experienced, RA population

First intervention in the strategy	Discounted costs	Discounted QALYs	CPQ compared with MTX strategy (£)	Incremental CPQ (£)
MTX	CiC information has been removed	CiC information has been removed	–	–
TCZ + MTX	CiC information has been removed	CiC information has been removed	31,647	31,647
ABT i.v. + MTX	CiC information has been removed	CiC information has been removed	32,806	42,791
IFX + MTX	CiC information has been removed	CiC information has been removed	33,283	91,638
ABT s.c. + MTX	CiC information has been removed	CiC information has been removed	35,721	Dominated
ADA + MTX	CiC information has been removed	CiC information has been removed	35,859	Extendedly dominated
GOL + MTX	CiC information has been removed	CiC information has been removed	35,977	Extendedly dominated
CTZ + MTX	CiC information has been removed	CiC information has been removed	35,736	150,620
ETN + MTX	CiC information has been removed	CiC information has been removed	37,174	Dominated

CPQ, cost per QALY gained.

**TABLE 203** Deterministic results having included RCTs with potentially low prior MTX exposure using ACR data mapped to EULAR data: linear cDMARD HAQ progression and a severe, MTX-experienced, RA population

First intervention in the strategy	Discounted costs	Discounted QALYs	CPQ compared with MTX strategy (£)	Incremental CPQ (£)
MTX	CiC information has been removed	CiC information has been removed	–	–
TCZ + MTX	CiC information has been removed	CiC information has been removed	34,228	34,228
ABT i.v. + MTX	CiC information has been removed	CiC information has been removed	34,493	36,870
IFX + MTX	CiC information has been removed	CiC information has been removed	34,870	258,927
CTZ + MTX	CiC information has been removed	CiC information has been removed	36,362	Dominated
ABT s.c. + MTX	CiC information has been removed	CiC information has been removed	37,610	Extendedly dominated
ADA + MTX	CiC information has been removed	CiC information has been removed	37,938	Extendedly dominated
GOL + MTX	CiC information has been removed	CiC information has been removed	37,693	261,545
ETN + MTX	CiC information has been removed	CiC information has been removed	38,550	Dominated

CPQ, cost per QALY gained.

**TABLE 204** Deterministic results having used the mapping of HAQ to utility from Malottki *et al.*<sup>171</sup> rather than Hernandez-Alava *et al.*<sup>276</sup> using ACR data mapped to EULAR data: linear cDMARD HAQ progression and a severe, MTX-experienced, RA population

First intervention in the strategy	Discounted costs	Discounted QALYs	CPQ compared with MTX strategy (£)	Incremental CPQ (£)
MTX	CiC information has been removed	CiC information has been removed	–	–
TCZ + MTX	CiC information has been removed	CiC information has been removed	29,087	29,087
ABT i.v. + MTX	CiC information has been removed	CiC information has been removed	29,472	32,461
IFX + MTX	CiC information has been removed	CiC information has been removed	29,940	Dominated
CTZ + MTX	CiC information has been removed	CiC information has been removed	30,948	Dominated
GOL + MTX	CiC information has been removed	CiC information has been removed	31,900	Extendedly dominated
ABT s.c. + MTX	CiC information has been removed	CiC information has been removed	31,970	Extendedly dominated
ADA + MTX	CiC information has been removed	CiC information has been removed	32,190	Dominated
ETN + MTX	CiC information has been removed	CiC information has been removed	33,104	176,415

CPQ, cost per QALY gained.

**TABLE 205** Deterministic results having used discount rates of 6% per annum for costs and 1.5% per annum for QALYs and using ACR data mapped to EULAR data: linear cDMARD HAQ progression and a severe, MTX-experienced, RA population

First intervention in the strategy	Discounted costs	Discounted QALYs	CPQ compared with MTX strategy (£)	Incremental CPQ (£)
MTX	CiC information has been removed	CiC information has been removed	–	–
TCZ + MTX	CiC information has been removed	CiC information has been removed	20,847	Extendedly dominated
ABT i.v. + MTX	CiC information has been removed	CiC information has been removed	20,379	20,379
IFX + MTX	CiC information has been removed	CiC information has been removed	20,739	Extendedly dominated
CTZ + MTX	CiC information has been removed	CiC information has been removed	21,424	Dominated
ABT s.c. + MTX	CiC information has been removed	CiC information has been removed	22,309	Extendedly dominated
ADA + MTX	CiC information has been removed	CiC information has been removed	22,486	Dominated
GOL + MTX	CiC information has been removed	CiC information has been removed	22,485	Dominated
ETN + MTX	CiC information has been removed	CiC information has been removed	23,184	199,830

CPQ, cost per QALY gained.

**TABLE 206** Deterministic results assuming 100-fold increased impact of AEs and using ACR data mapped to EULAR data: linear cDMARD HAQ progression and a severe, MTX-experienced, RA population

First intervention in the strategy	Discounted costs	Discounted QALYs	CPQ compared with MTX strategy (£)	Incremental CPQ (£)
MTX	CiC information has been removed	CiC information has been removed	–	–
TCZ + MTX	CiC information has been removed	CiC information has been removed	33,139	33,139
ABT i.v. + MTX	CiC information has been removed	CiC information has been removed	33,923	40,436
IFX + MTX	CiC information has been removed	CiC information has been removed	34,236	Dominated
CTZ + MTX	CiC information has been removed	CiC information has been removed	35,603	Dominated
ABT s.c. + MTX	CiC information has been removed	CiC information has been removed	36,703	Extendedly dominated
ADA + MTX	CiC information has been removed	CiC information has been removed	36,861	Dominated
GOL + MTX	CiC information has been removed	CiC information has been removed	36,819	Extendedly dominated
ETN + MTX	CiC information has been removed	CiC information has been removed	38,160	180,120

CPQ, cost per QALY gained.

**TABLE 207** Deterministic results having used the relationship between HAQ and pain derived from ERAS: linear cDMARD HAQ progression and a severe, MTX-experienced, RA population

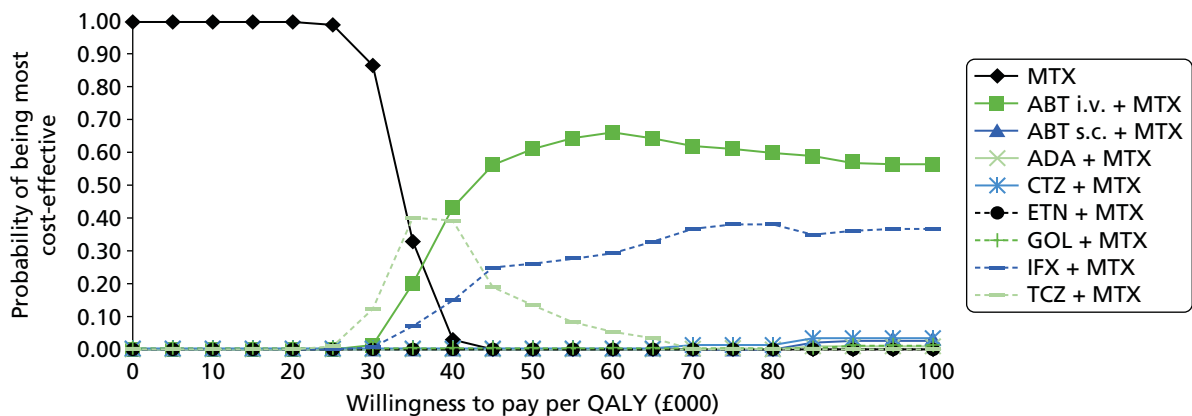
First intervention in the strategy	Discounted costs	Discounted QALYs	CPQ compared with MTX strategy (£)	Incremental CPQ (£)
MTX	CiC information has been removed	CiC information has been removed	–	–
TCZ + MTX	CiC information has been removed	CiC information has been removed	41,248	41,248
ABT i.v. + MTX	CiC information has been removed	CiC information has been removed	41,523	43,865
IFX + MTX	CiC information has been removed	CiC information has been removed	41,926	Extendedly dominated
CTZ + MTX	CiC information has been removed	CiC information has been removed	43,663	Dominated
ABT s.c. + MTX	CiC information has been removed	CiC information has been removed	45,232	Extendedly dominated
ADA + MTX	CiC information has been removed	CiC information has been removed	45,383	Dominated
GOL + MTX	CiC information has been removed	CiC information has been removed	45,326	Extendedly dominated
ETN + MTX	CiC information has been removed	CiC information has been removed	46,770	142,639

CPQ, cost per QALY gained.

**TABLE 208** Probabilistic base-case results using ACR data mapped to EULAR data: linear cDMARD HAQ progression and a severe, MTX-experienced, RA population

First intervention in the strategy	Discounted costs	Discounted QALYs	CPQ compared with MTX strategy (£)	Incremental CPQ (£)
MTX	CiC information has been removed	CiC information has been removed	–	–
TCZ + MTX	CiC information has been removed	CiC information has been removed	33,537	33,537
ABT i.v. + MTX	CiC information has been removed	CiC information has been removed	34,047	38,505
IFX + MTX	CiC information has been removed	CiC information has been removed	34,504	148,650
CTZ + MTX	CiC information has been removed	CiC information has been removed	35,803	Dominated
ABT s.c. + MTX	CiC information has been removed	CiC information has been removed	36,957	Extendedly dominated
ADA + MTX	CiC information has been removed	CiC information has been removed	37,163	Dominated
GOL + MTX	CiC information has been removed	CiC information has been removed	37,139	Extendedly dominated
ETN + MTX	CiC information has been removed	CiC information has been removed	38,328	244,601

CPQ, cost per QALY gained.



**FIGURE 122** The CEAC using ACR data mapped to EULAR data and assuming linear CDMARD HAQ progression.

**European League Against Rheumatism response measure: Early Rheumatoid Arthritis Study cDMARD Health Assessment Questionnaire progression and a moderate, methotrexate-experienced, rheumatoid arthritis population**

The base-case results for this population and those from sensitivity analyses are provided in Tables 209–215. The CEAC for the base case is shown in Figure 123.

It is seen that the ICERs of all the bDMARDs compared with the MTX strategy are in the region of £48,000–53,000.

It is seen that at a willingness to pay of £30,000 the MTX strategy has a very high probability of being optimal.

**TABLE 209** Deterministic base-case results using EULAR data directly: ERAS cDMARD HAQ progression and a moderate, MTX-experienced, RA population

First intervention in the strategy	Discounted costs	Discounted QALYs	CPQ compared with MTX strategy (£)	Incremental CPQ (£)
MTX	CiC information has been removed	CiC information has been removed	–	–
TCZ + MTX	CiC information has been removed	CiC information has been removed	52,032	Extendedly dominated
ABT i.v. + MTX	CiC information has been removed	CiC information has been removed	48,816	48,816
IFX + MTX	CiC information has been removed	CiC information has been removed	49,071	Dominated
CTZ + MTX	CiC information has been removed	CiC information has been removed	50,891	Extendedly dominated
ADA + MTX	CiC information has been removed	CiC information has been removed	52,093	Dominated
GOL + MTX	CiC information has been removed	CiC information has been removed	52,203	Extendedly dominated
ETN + MTX	CiC information has been removed	CiC information has been removed	52,275	89,540

CPQ, cost per QALY gained.

**TABLE 210** Deterministic results having included RCTs with a small proportion of previous bDMARD use (with adequate prior MTX exposure) using EULAR data directly: ERAS cDMARD HAQ progression and a moderate, MTX-experienced, RA population

First intervention in the strategy	Discounted costs	Discounted QALYs	CPQ compared with MTX strategy (£)	Incremental CPQ (£)
MTX	CiC information has been removed	CiC information has been removed	–	–
TCZ + MTX	CiC information has been removed	CiC information has been removed	52,480	Extendedly dominated
ABT i.v. + MTX	CiC information has been removed	CiC information has been removed	48,494	48,494
IFX + MTX	CiC information has been removed	CiC information has been removed	49,409	Dominated
ADA + MTX	CiC information has been removed	CiC information has been removed	52,827	Dominated
GOL + MTX	CiC information has been removed	CiC information has been removed	51,858	Extendedly dominated
CTZ + MTX	CiC information has been removed	CiC information has been removed	51,782	94,534
ETN + MTX	CiC information has been removed	CiC information has been removed	52,861	108,335

CPQ, cost per QALY gained.

**TABLE 211** Deterministic results having used the mapping of HAQ to utility from Malottki *et al.*<sup>171</sup> rather than Hernandez-Alava *et al.*<sup>276</sup> using EULAR data directly: ERAS cDMARD HAQ progression and a moderate, MTX-experienced, RA population

First intervention in the strategy	Discounted costs	Discounted QALYs	CPQ compared with MTX strategy (£)	Incremental CPQ (£)
MTX	CiC information has been removed	CiC information has been removed	–	–
TCZ + MTX	CiC information has been removed	CiC information has been removed	36,290	Extendedly dominated
ABT i.v. + MTX	CiC information has been removed	CiC information has been removed	34,666	Extendedly dominated
IFX + MTX	CiC information has been removed	CiC information has been removed	34,147	34,147
CTZ + MTX	CiC information has been removed	CiC information has been removed	36,848	Dominated
ADA + MTX	CiC information has been removed	CiC information has been removed	36,272	Extendedly dominated
GOL + MTX	CiC information has been removed	CiC information has been removed	36,573	Dominated
ETN + MTX	CiC information has been removed	CiC information has been removed	36,834	69,318

CPQ, cost per QALY gained.

**TABLE 212** Deterministic results having used discount rates of 6% per annum for costs and 1.5% per annum for QALYs and using EULAR data directly: ERAS cDMARD HAQ progression and a moderate, MTX-experienced, RA population

First intervention in the strategy	Discounted costs	Discounted QALYs	CPQ compared with MTX strategy (£)	Incremental CPQ (£)
MTX	CiC information has been removed	CiC information has been removed	–	–
TCZ + MTX	CiC information has been removed	CiC information has been removed	33,821	Extendedly dominated
ABT i.v. + MTX	CiC information has been removed	CiC information has been removed	30,491	30,491
IFX + MTX	CiC information has been removed	CiC information has been removed	30,880	Dominated
CTZ + MTX	CiC information has been removed	CiC information has been removed	32,723	Extendedly dominated
ADA + MTX	CiC information has been removed	CiC information has been removed	32,079	Extendedly dominated
GOL + MTX	CiC information has been removed	CiC information has been removed	32,788	Extendedly dominated
ETN + MTX	CiC information has been removed	CiC information has been removed	32,801	57,940

CPQ, cost per QALY gained.

**TABLE 213** Deterministic results assuming 100-fold increased impact of AEs and using EULAR data directly: ERAS cDMARD HAQ progression and a moderate, MTX-experienced, RA population

First intervention in the strategy	Discounted costs	Discounted QALYs	CPQ compared with MTX strategy (£)	Incremental CPQ (£)
MTX	CiC information has been removed	CiC information has been removed	–	–
TCZ + MTX	CiC information has been removed	CiC information has been removed	52,423	Extendedly dominated
ABT i.v. + MTX	CiC information has been removed	CiC information has been removed	48,186	48,186
IFX + MTX	CiC information has been removed	CiC information has been removed	49,231	Dominated
CTZ + MTX	CiC information has been removed	CiC information has been removed	52,157	Dominated
ADA + MTX	CiC information has been removed	CiC information has been removed	51,015	Extendedly dominated
GOL + MTX	CiC information has been removed	CiC information has been removed	52,813	Dominated
ETN + MTX	CiC information has been removed	CiC information has been removed	52,762	117,717

CPQ, cost per QALY gained.

**TABLE 214** Deterministic results having used the relationship between HAQ and pain derived from ERAS: ERAS cDMARD HAQ progression and a moderate, MTX-experienced, RA population

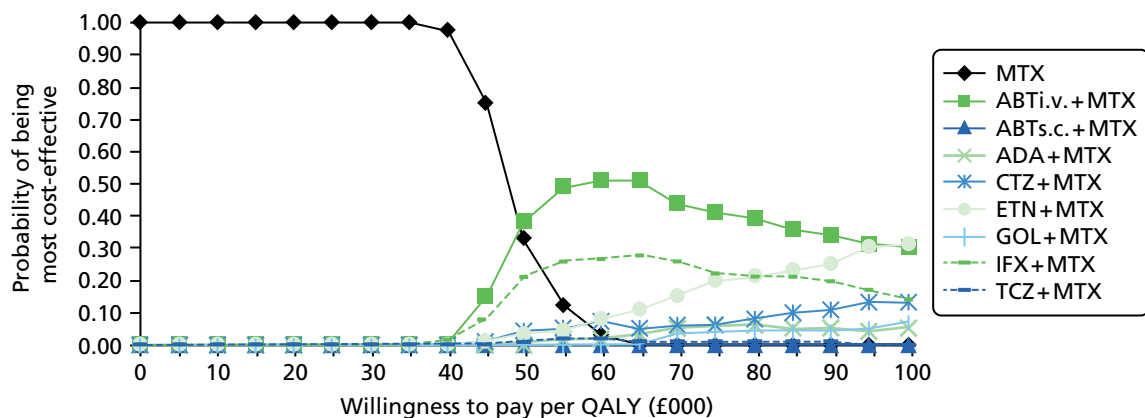
First intervention in the strategy	Discounted costs	Discounted QALYs	CPQ compared with MTX strategy (£)	Incremental CPQ (£)
MTX	CiC information has been removed	CiC information has been removed	–	–
TCZ + MTX	CiC information has been removed	CiC information has been removed	57,687	Extendedly dominated
IFX + MTX	CiC information has been removed	CiC information has been removed	56,810	Extendedly dominated
ABT i.v. + MTX	CiC information has been removed	CiC information has been removed	55,790	55,790
ADA + MTX	CiC information has been removed	CiC information has been removed	58,483	Dominated
CTZ + MTX	CiC information has been removed	CiC information has been removed	58,078	Extendedly dominated
GOL + MTX	CiC information has been removed	CiC information has been removed	59,136	Extendedly dominated
ETN + MTX	CiC information has been removed	CiC information has been removed	59,475	88,312

CPQ, cost per QALY gained.

**TABLE 215** Probabilistic base-case results using EULAR data directly: ERAS cDMARD HAQ progression and a moderate, MTX-experienced, RA population

First intervention in the strategy	Discounted costs	Discounted QALYs	CPQ compared with MTX strategy (£)	Incremental CPQ (£)
MTX	CiC information has been removed	CiC information has been removed	–	–
TCZ + MTX	CiC information has been removed	CiC information has been removed	52,032	Extendedly dominated
ABT i.v. + MTX	CiC information has been removed	CiC information has been removed	48,816	48,816
IFX + MTX	CiC information has been removed	CiC information has been removed	49,071	Dominated
CTZ + MTX	CiC information has been removed	CiC information has been removed	50,891	Extendedly dominated
ADA + MTX	CiC information has been removed	CiC information has been removed	52,093	Dominated
GOL + MTX	CiC information has been removed	CiC information has been removed	52,203	Extendedly dominated
ETN + MTX	CiC information has been removed	CiC information has been removed	52,275	89,540

CPQ, cost per QALY gained.



**FIGURE 123** The CEAC when using EULAR data directly: ERAS cDMARD HAQ progression and a moderate, MTX-experienced, RA population.

**European League Against Rheumatism response measure: linear cDMARD Health Assessment Questionnaire progression and a moderate, methotrexate-experienced, rheumatoid arthritis population**

The base-case results for this population and those from sensitivity analyses are provided in Tables 216–222. The CEAC for the base case is shown in Figure 124.

It is seen that the ICERs of all the bDMARDs compared with the MTX strategy are in the region of £36,000–42,000.

It is seen that at a willingness to pay of £30,000 per QALY the MTX strategy has the highest probability of being optimal.



**TABLE 216** Deterministic base-case results using EULAR data directly: linear cDMARD HAQ progression and a moderate, MTX-experienced, RA population

First intervention in the strategy	Discounted costs	Discounted QALYs	CPQ compared with MTX strategy (£)	Incremental CPQ (£)
MTX	CiC information has been removed	CiC information has been removed	–	–
TCZ + MTX	CiC information has been removed	CiC information has been removed	37,769	Extendedly dominated
ABT i.v. + MTX	CiC information has been removed	CiC information has been removed	36,815	36,815
IFX + MTX	CiC information has been removed	CiC information has been removed	37,270	Extendedly dominated
ADA + MTX	CiC information has been removed	CiC information has been removed	39,702	Extendedly dominated
CTZ + MTX	CiC information has been removed	CiC information has been removed	39,468	Extendedly dominated
GOL + MTX	CiC information has been removed	CiC information has been removed	40,379	Extendedly dominated
ETN + MTX	CiC information has been removed	CiC information has been removed	41,265	110,772

CPQ, cost per QALY gained.

**TABLE 217** Deterministic results having included RCTs with a small proportion of previous bDMARD use (with adequate prior MTX exposure) using EULAR data directly: linear cDMARD HAQ progression and a moderate, MTX-experienced, RA population

First intervention in the strategy	Discounted costs	Discounted QALYs	CPQ compared with MTX strategy (£)	Incremental CPQ (£)
MTX	CiC information has been removed	CiC information has been removed	–	–
TCZ + MTX	CiC information has been removed	CiC information has been removed	39,018	Extendedly dominated
ABT i.v. + MTX	CiC information has been removed	CiC information has been removed	39,012	39,012
IFX + MTX	CiC information has been removed	CiC information has been removed	39,767	Dominated
ADA + MTX	CiC information has been removed	CiC information has been removed	41,515	Extendedly dominated
GOL + MTX	CiC information has been removed	CiC information has been removed	42,197	Extendedly dominated
CTZ + MTX	CiC information has been removed	CiC information has been removed	42,137	71,973
ETN + MTX	CiC information has been removed	CiC information has been removed	43,054	Dominated

CPQ, cost per QALY gained.

**TABLE 218** Deterministic results having used the mapping of HAQ to utility from Malottki *et al.*<sup>171</sup> rather than Hernandez-Alava *et al.*<sup>276</sup> using EULAR data directly: linear cDMARD HAQ progression and a moderate, MTX-experienced, RA population

First intervention in the strategy	Discounted costs	Discounted QALYs	CPQ compared with MTX strategy (£)	Incremental CPQ (£)
MTX	CiC information has been removed	CiC information has been removed	–	–
TCZ + MTX	CiC information has been removed	CiC information has been removed	30,439	Extendedly dominated
ABT i.v. + MTX	CiC information has been removed	CiC information has been removed	29,571	29,571
IFX + MTX	CiC information has been removed	CiC information has been removed	29,942	Dominated
ADA + MTX	CiC information has been removed	CiC information has been removed	32,260	Extendedly dominated
CTZ + MTX	CiC information has been removed	CiC information has been removed	31,257	Extendedly dominated
GOL + MTX	CiC information has been removed	CiC information has been removed	32,137	Dominated
ETN + MTX	CiC information has been removed	CiC information has been removed	32,313	64,372

CPQ, cost per QALY gained.

**TABLE 219** Deterministic results having used discount rates of 6% per annum for costs and 1.5% per annum for QALYs and using EULAR data directly: linear cDMARD HAQ progression and a moderate, MTX-experienced, RA population

First intervention in the strategy	Discounted costs	Discounted QALYs	CPQ compared with MTX strategy (£)	Incremental CPQ (£)
MTX	CiC information has been removed	CiC information has been removed	–	–
ABT i.v. + MTX	CiC information has been removed	CiC information has been removed	20,043	20,043
TCZ + MTX	CiC information has been removed	CiC information has been removed	21,297	Dominated
IFX + MTX	CiC information has been removed	CiC information has been removed	20,370	Extendedly dominated
ADA + MTX	CiC information has been removed	CiC information has been removed	21,972	Dominated
CTZ + MTX	CiC information has been removed	CiC information has been removed	21,758	Extendedly dominated
GOL + MTX	CiC information has been removed	CiC information has been removed	22,216	Extendedly dominated
ETN + MTX	CiC information has been removed	CiC information has been removed	22,936	80,582

CPQ, cost per QALY gained.

**TABLE 220** Deterministic results assuming 100-fold increased impact of AEs and using EULAR data directly: linear cDMARD HAQ progression and a moderate, MTX-experienced, RA population

First intervention in the strategy	Discounted costs	Discounted QALYs	CPQ compared with MTX strategy (£)	Incremental CPQ (£)
MTX	CiC information has been removed	CiC information has been removed	–	–
TCZ + MTX	CiC information has been removed	CiC information has been removed	36,912	Extendedly dominated
ABT i.v. + MTX	CiC information has been removed	CiC information has been removed	36,224	36,224
IFX + MTX	CiC information has been removed	CiC information has been removed	37,115	Dominated
ADA + MTX	CiC information has been removed	CiC information has been removed	39,254	Extendedly dominated
CTZ + MTX	CiC information has been removed	CiC information has been removed	39,587	Extendedly dominated
GOL + MTX	CiC information has been removed	CiC information has been removed	40,239	Extendedly dominated
ETN + MTX	CiC information has been removed	CiC information has been removed	41,128	125,849

CPQ, cost per QALY gained.

**TABLE 221** Deterministic results having used the relationship between HAQ and pain derived from ERAS: linear cDMARD HAQ progression and a moderate, MTX-experienced, RA population

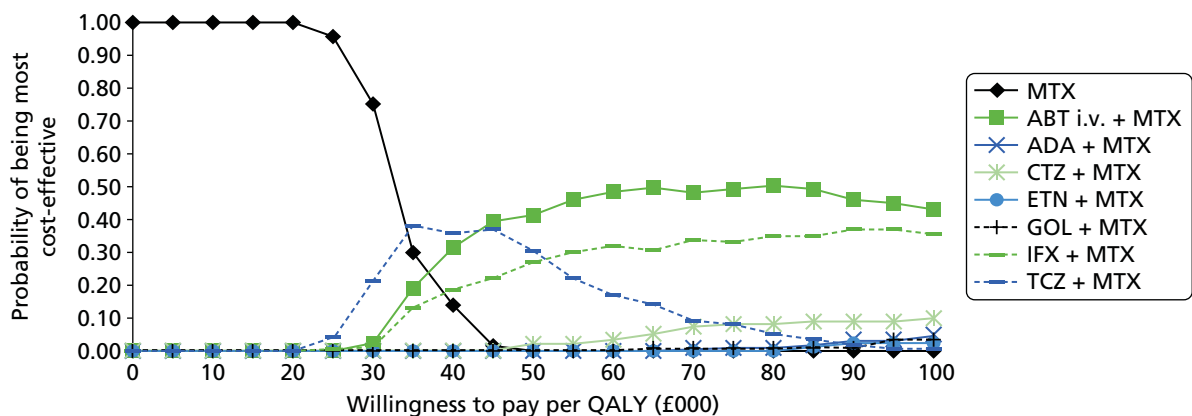
First intervention in the strategy	Discounted costs	Discounted QALYs	CPQ compared with MTX strategy (£)	Incremental CPQ (£)
MTX	CiC information has been removed	CiC information has been removed	–	–
TCZ + MTX	CiC information has been removed	CiC information has been removed	46,453	Extendedly dominated
ABT i.v. + MTX	CiC information has been removed	CiC information has been removed	45,674	45,674
IFX + MTX	CiC information has been removed	CiC information has been removed	45,886	Dominated
CTZ + MTX	CiC information has been removed	CiC information has been removed	48,343	Extendedly dominated
ADA + MTX	CiC information has been removed	CiC information has been removed	49,405	Dominated
GOL + MTX	CiC information has been removed	CiC information has been removed	49,113	Extendedly dominated
ETN + MTX	CiC information has been removed	CiC information has been removed	50,252	115,803

CPQ, cost per QALY gained.

**TABLE 222** Probabilistic base-case results using EULAR data directly: linear cDMARD HAQ progression and a moderate, MTX-experienced, RA population

First intervention in the strategy	Discounted costs	Discounted QALYs	CPQ compared with MTX strategy (£)	Incremental CPQ (£)
MTX	CiC information has been removed	CiC information has been removed	–	–
TCZ + MTX	CiC information has been removed	CiC information has been removed	38,152	Extendedly dominated
ABT i.v. + MTX	CiC information has been removed	CiC information has been removed	34,843	34,843
IFX + MTX	CiC information has been removed	CiC information has been removed	35,425	Dominated
CTZ + MTX	CiC information has been removed	CiC information has been removed	36,644	Extendedly dominated
ADA + MTX	CiC information has been removed	CiC information has been removed	37,583	Dominated
GOL + MTX	CiC information has been removed	CiC information has been removed	37,779	Extendedly dominated
ETN + MTX	CiC information has been removed	CiC information has been removed	38,355	86,917

CPQ, cost per QALY gained.

**FIGURE 124** The CEAC using EULAR data directly and assuming linear cDMARD HAQ progression and a moderate, MTX-experienced, RA population.

### American College of Rheumatology response measure: Early Rheumatoid Arthritis Study cDMARD Health Assessment Questionnaire progression and a moderate, methotrexate-experienced, rheumatoid arthritis population

The base-case results for this population and those from sensitivity analyses are provided in *Tables 223–230*.

It is seen that the ICERs of all the bDMARDs compared with the MTX strategy are in the region of £47,000–54,000.

**TABLE 223** Deterministic base-case results using EULAR data directly: ERAS cDMARD HAQ progression and a moderate, MTX-experienced, RA population

First intervention in the strategy	Discounted costs	Discounted QALYs	CPQ compared with MTX strategy (£)	Incremental CPQ (£)
MTX	CiC information has been removed	CiC information has been removed	–	–
TCZ + MTX	CiC information has been removed	CiC information has been removed	52,410	Extendedly dominated
ABT i.v. + MTX	CiC information has been removed	CiC information has been removed	47,833	47,833
IFX + MTX	CiC information has been removed	CiC information has been removed	48,474	101,458
CTZ + MTX	CiC information has been removed	CiC information has been removed	50,044	Dominated
ADA + MTX	CiC information has been removed	CiC information has been removed	51,625	Dominated
GOL + MTX	CiC information has been removed	CiC information has been removed	51,573	Dominated
ABT s.c. + MTX	CiC information has been removed	CiC information has been removed	51,341	Extendedly dominated
ETN + MTX	CiC information has been removed	CiC information has been removed	53,006	468,878

CPQ, cost per QALY gained.

**TABLE 224** Deterministic results having included RCTs with a small proportion of previous bDMARD use (with adequate prior MTX exposure) using ACR data mapped to EULAR data: ERAS cDMARD HAQ progression and a moderate, MTX-experienced, RA population

First intervention in the strategy	Discounted costs	Discounted QALYs	CPQ compared with MTX strategy (£)	Incremental CPQ (£)
MTX	CiC information has been removed	CiC information has been removed	–	–
TCZ + MTX	CiC information has been removed	CiC information has been removed	52,779	Extendedly dominated
ABT i.v. + MTX	CiC information has been removed	CiC information has been removed	47,839	47,839
IFX + MTX	CiC information has been removed	CiC information has been removed	49,646	Dominated
ADA + MTX	CiC information has been removed	CiC information has been removed	52,111	Extendedly dominated
ABT s.c. + MTX	CiC information has been removed	CiC information has been removed	52,771	Dominated
GOL + MTX	CiC information has been removed	CiC information has been removed	52,489	Extendedly dominated
CTZ + MTX	CiC information has been removed	CiC information has been removed	52,215	167,643
ETN + MTX	CiC information has been removed	CiC information has been removed	53,866	Dominated

CPQ, cost per QALY gained.

**TABLE 225** Deterministic results having included RCTs with a small proportion of previous bDMARD use (irrespective of prior MTX exposure) using ACR data mapped to EULAR data: ERAS cDMARD HAQ progression and a moderate, MTX-experienced, RA population

First intervention in the strategy	Discounted costs	Discounted QALYs	CPQ compared with MTX strategy (£)	Incremental CPQ (£)
MTX	CiC information has been removed	CiC information has been removed	–	–
TCZ + MTX	CiC information has been removed	CiC information has been removed	53,650	Extendedly dominated
ABT i.v. + MTX	CiC information has been removed	CiC information has been removed	46,985	46,985
IFX + MTX	CiC information has been removed	CiC information has been removed	49,149	Dominated
ABT s.c. + MTX	CiC information has been removed	CiC information has been removed	51,016	Extendedly dominated
ADA + MTX	CiC information has been removed	CiC information has been removed	52,073	Dominated
GOL + MTX	CiC information has been removed	CiC information has been removed	52,375	Dominated
CTZ + MTX	CiC information has been removed	CiC information has been removed	51,296	145,070
ETN + MTX	CiC information has been removed	CiC information has been removed	53,588	Dominated

CPQ, cost per QALY gained.

**TABLE 226** Deterministic results having included RCTs with potentially low prior MTX exposure using ACR data mapped to EULAR data: ERAS cDMARD HAQ progression and a moderate, MTX-experienced, RA population

First intervention in the strategy	Discounted costs	Discounted QALYs	CPQ compared with MTX strategy (£)	Incremental CPQ (£)
MTX	CiC information has been removed	CiC information has been removed	–	–
TCZ + MTX	CiC information has been removed	CiC information has been removed	52,464	Extendedly dominated
ABT i.v. + MTX	CiC information has been removed	CiC information has been removed	47,673	47,673
IFX + MTX	CiC information has been removed	CiC information has been removed	47,685	48,465
CTZ + MTX	CiC information has been removed	CiC information has been removed	51,273	Dominated
ABT s.c. + MTX	CiC information has been removed	CiC information has been removed	51,471	Dominated
GOL + MTX	CiC information has been removed	CiC information has been removed	51,230	Extendedly dominated
ADA + MTX	CiC information has been removed	CiC information has been removed	51,540	399,034
ETN + MTX	CiC information has been removed	CiC information has been removed	53,193	Dominated

CPQ, cost per QALY gained.

**TABLE 227** Deterministic results having used the mapping of HAQ to utility from Malottki *et al.*<sup>171</sup> rather than Hernandez-Alava *et al.*<sup>276</sup> using ACR data mapped to EULAR data: ERAS cDMARD HAQ progression and a moderate, MTX-experienced, RA population

First intervention in the strategy	Discounted costs	Discounted QALYs	CPQ compared with MTX strategy (£)	Incremental CPQ (£)
MTX	CiC information has been removed	CiC information has been removed	–	–
TCZ + MTX	CiC information has been removed	CiC information has been removed	37,766	Extendedly dominated
ABT i.v. + MTX	CiC information has been removed	CiC information has been removed	34,586	34,586
IFX + MTX	CiC information has been removed	CiC information has been removed	34,852	64,571
CTZ + MTX	CiC information has been removed	CiC information has been removed	36,358	Dominated
ADA + MTX	CiC information has been removed	CiC information has been removed	37,506	Dominated
ABT s.c. + MTX	CiC information has been removed	CiC information has been removed	37,229	Extendedly dominated
GOL + MTX	CiC information has been removed	CiC information has been removed	37,535	Extendedly dominated
ETN + MTX	CiC information has been removed	CiC information has been removed	38,247	242,769

CPQ, cost per QALY gained.

**TABLE 228** Deterministic results having used discount rates of 6% per annum for costs and 1.5% per annum for QALYs and using ACR data mapped to EULAR data: ERAS cDMARD HAQ progression and a moderate, MTX-experienced, RA population

First intervention in the strategy	Discounted costs	Discounted QALYs	CPQ compared with MTX strategy (£)	Incremental CPQ (£)
MTX	CiC information has been removed	CiC information has been removed	–	–
TCZ + MTX	CiC information has been removed	CiC information has been removed	33,852	Extendedly dominated
ABT i.v. + MTX	CiC information has been removed	CiC information has been removed	30,721	30,721
IFX + MTX	CiC information has been removed	CiC information has been removed	31,023	Extendedly dominated
CTZ + MTX	CiC information has been removed	CiC information has been removed	32,074	Extendedly dominated
GOL + MTX	CiC information has been removed	CiC information has been removed	33,016	Extendedly dominated
ABT s.c. + MTX	CiC information has been removed	CiC information has been removed	32,807	Extendedly dominated
ADA + MTX	CiC information has been removed	CiC information has been removed	33,300	Dominated
ETN + MTX	CiC information has been removed	CiC information has been removed	33,712	97,679

CPQ, cost per QALY gained.

**TABLE 229** Deterministic results assuming 100-fold increased impact of AEs and using ACR data mapped to EULAR data: ERAS cDMARD HAQ progression and a moderate, MTX-experienced, RA population

First intervention in the strategy	Discounted costs	Discounted QALYs	CPQ compared with MTX strategy (£)	Incremental CPQ (£)
MTX	CiC information has been removed	CiC information has been removed	–	–
TCZ + MTX	CiC information has been removed	CiC information has been removed	52,982	Extendedly dominated
ABT i.v. + MTX	CiC information has been removed	CiC information has been removed	48,644	48,644
IFX + MTX	CiC information has been removed	CiC information has been removed	48,818	90,480
CTZ + MTX	CiC information has been removed	CiC information has been removed	51,151	Dominated
ABT s.c. + MTX	CiC information has been removed	CiC information has been removed	52,012	Extendedly dominated
GOL + MTX	CiC information has been removed	CiC information has been removed	52,104	Extendedly dominated
ADA + MTX	CiC information has been removed	CiC information has been removed	52,992	Dominated
ETN + MTX	CiC information has been removed	CiC information has been removed	53,614	183,170

CPQ, cost per QALY gained.

**TABLE 230** Deterministic results having used the relationship between HAQ and pain derived from ERAS: ERAS cDMARD HAQ progression and a moderate, MTX-experienced, RA population

First intervention in the strategy	Discounted costs	Discounted QALYs	CPQ compared with MTX strategy (£)	Incremental CPQ (£)
MTX	CiC information has been removed	CiC information has been removed	–	–
TCZ + MTX	CiC information has been removed	CiC information has been removed	59,499	Extendedly dominated
ABT i.v. + MTX	CiC information has been removed	CiC information has been removed	54,356	54,356
IFX + MTX	CiC information has been removed	CiC information has been removed	54,514	67,602
CTZ + MTX	CiC information has been removed	CiC information has been removed	58,334	Dominated
ADA + MTX	CiC information has been removed	CiC information has been removed	59,480	Extendedly dominated
GOL + MTX	CiC information has been removed	CiC information has been removed	59,394	Extendedly dominated
ABT s.c. + MTX	CiC information has been removed	CiC information has been removed	59,107	Extendedly dominated
ETN + MTX	CiC information has been removed	CiC information has been removed	60,912	372,652

CPQ, cost per QALY gained.



### Probabilistic results using American College of Rheumatology data mapped to European League Against Rheumatism data and assuming Early Rheumatoid Arthritis Study cDMARD Health Assessment Questionnaire progression and a moderate, methotrexate-experienced, rheumatoid arthritis population

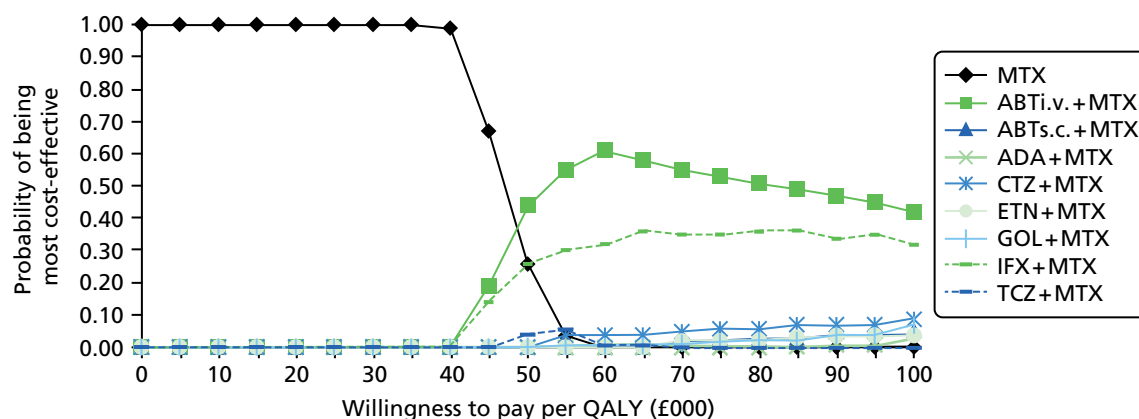
The probabilistic base-case results for this population and those from sensitivity analyses are provided in Table 231. The CEAC for the base case is shown in Figure 125.

It is seen that at a willingness to pay of £30,000 the MTX strategy has a very high probability of being optimal.

**TABLE 231** Probabilistic base-case results using ACR data mapped to EULAR data: ERAS cDMARD HAQ progression and a moderate, MTX-experienced, RA population

First intervention in the strategy	Discounted costs	Discounted QALYs	CPQ compared with MTX strategy (£)	Incremental CPQ (£)
MTX	CiC information has been removed	CiC information has been removed	–	–
TCZ + MTX	CiC information has been removed	CiC information has been removed	51,651	Extendedly dominated
ABT i.v. + MTX	CiC information has been removed	CiC information has been removed	47,658	47,658
IFX + MTX	CiC information has been removed	CiC information has been removed	48,260	110,763
CTZ + MTX	CiC information has been removed	CiC information has been removed	50,444	Dominated
ABT s.c. + MTX	CiC information has been removed	CiC information has been removed	51,566	Extendedly dominated
ADA + MTX	CiC information has been removed	CiC information has been removed	51,674	Dominated
GOL + MTX	CiC information has been removed	CiC information has been removed	51,638	Extendedly dominated
ETN + MTX	CiC information has been removed	CiC information has been removed	53,133	247,395

CPQ, cost per QALY gained.



**FIGURE 125** The CEAC when using ACR data mapped to EULAR data: ERAS cDMARD HAQ progression and a moderate, MTX-experienced, RA population.

### American College of Rheumatology response measure: linear cDMARD Health Assessment Questionnaire progression and a moderate, methotrexate-experienced, rheumatoid arthritis population

The base-case results for this population and those from sensitivity analyses are provided in *Tables 232–239*.

It is seen that the ICERs of all the bDMARDs compared with the MTX strategy are in the region of £36,000–41,000.

### Probabilistic results using American College of Rheumatology data mapped to European League Against Rheumatism data and assuming linear cDMARD Health Assessment Questionnaire progression

The probabilistic base-case results for this population and those from sensitivity analyses are provided in *Table 240*. The CEAC for the base case is shown in *Figure 126*.

It is seen at a willingness to pay of £30,000 per QALY that the MTX strategy has a very high likelihood of being optimal.

**TABLE 232** Deterministic base-case results using ACR data mapped to EULAR data: linear cDMARD HAQ progression and a moderate, MTX-experienced, RA population

First intervention in the strategy	Discounted costs	Discounted QALYs	CPQ compared with MTX strategy (£)	Incremental CPQ (£)
MTX	CiC information has been removed	CiC information has been removed	–	–
TCZ + MTX	CiC information has been removed	CiC information has been removed	36,576	36,576
IFX + MTX	CiC information has been removed	CiC information has been removed	36,916	39,965
ABT i.v. + MTX	CiC information has been removed	CiC information has been removed	37,372	Dominated
CTZ + MTX	CiC information has been removed	CiC information has been removed	38,039	Dominated
GOL + MTX	CiC information has been removed	CiC information has been removed	39,847	Extendedly dominated
ABT s.c. + MTX	CiC information has been removed	CiC information has been removed	40,035	Extendedly dominated
ADA + MTX	CiC information has been removed	CiC information has been removed	39,785	264,074
ETN + MTX	CiC information has been removed	CiC information has been removed	40,893	Dominated

CPQ, cost per QALY gained.

**TABLE 233** Deterministic results having included RCTs with a small proportion of previous bDMARD use (with adequate prior MTX exposure) using ACR data mapped to EULAR data: linear cDMARD HAQ progression and a moderate, MTX-experienced, RA population

First intervention in the strategy	Discounted costs	Discounted QALYs	CPQ compared with MTX strategy (£)	Incremental CPQ (£)
MTX	CiC information has been removed	CiC information has been removed	–	–
TCZ + MTX	CiC information has been removed	CiC information has been removed	33,337	33,337
ABT i.v. + MTX	CiC information has been removed	CiC information has been removed	34,568	Extendedly dominated
IFX + MTX	CiC information has been removed	CiC information has been removed	34,413	43,931
ADA + MTX	CiC information has been removed	CiC information has been removed	36,691	Dominated
ABT s.c. + MTX	CiC information has been removed	CiC information has been removed	37,177	Dominated
CTZ + MTX	CiC information has been removed	CiC information has been removed	37,111	Extendedly dominated
GOL + MTX	CiC information has been removed	CiC information has been removed	37,387	275,630
ETN + MTX	CiC information has been removed	CiC information has been removed	39,123	Dominated

CPQ, cost per QALY gained.

**TABLE 234** Deterministic results having included RCTs with a small proportion of previous bDMARD use (irrespective of prior MTX exposure) using ACR data mapped to EULAR data: linear cDMARD HAQ progression and a moderate, MTX-experienced, RA population

First intervention in the strategy	Discounted costs	Discounted QALYs	CPQ compared with MTX strategy (£)	Incremental CPQ (£)
MTX	CiC information has been removed	CiC information has been removed	–	–
TCZ + MTX	CiC information has been removed	CiC information has been removed	39,495	Extendedly dominated
ABT i.v. + MTX	CiC information has been removed	CiC information has been removed	34,536	17,203
IFX + MTX	CiC information has been removed	CiC information has been removed	37,952	Dominated
ABT s.c. + MTX	CiC information has been removed	CiC information has been removed	37,623	Extendedly dominated
ADA + MTX	CiC information has been removed	CiC information has been removed	37,909	Extendedly dominated
GOL + MTX	CiC information has been removed	CiC information has been removed	41,375	Dominated
CTZ + MTX	CiC information has been removed	CiC information has been removed	37,765	129,483
ETN + MTX	CiC information has been removed	CiC information has been removed	42,666	Dominated

CPQ, cost per QALY gained.

**TABLE 235** Deterministic results having included RCTs with potentially low prior MTX exposure using ACR data mapped to EULAR data: linear cDMARD HAQ progression and a moderate, MTX-experienced, RA population

First intervention in the strategy	Discounted costs	Discounted QALYs	CPQ compared with MTX strategy (£)	Incremental CPQ (£)
MTX	CiC information has been removed	CiC information has been removed	–	–
TCZ + MTX	CiC information has been removed	CiC information has been removed	40,094	Extendedly dominated
ABT i.v. + MTX	CiC information has been removed	CiC information has been removed	35,589	35,589
IFX + MTX	CiC information has been removed	CiC information has been removed	39,245	Dominated
CTZ + MTX	CiC information has been removed	CiC information has been removed	37,348	Dominated
ADA + MTX	CiC information has been removed	CiC information has been removed	38,788	807,662
ABT s.c. + MTX	CiC information has been removed	CiC information has been removed	39,151	Dominated
GOL + MTX	CiC information has been removed	CiC information has been removed	42,274	Dominated
ETN + MTX	CiC information has been removed	CiC information has been removed	42,085	Dominated

CPQ, cost per QALY gained.

**TABLE 236** Deterministic results having used the mapping of HAQ to utility from Malottki *et al.*<sup>171</sup> rather than Hernandez-Alava *et al.*<sup>276</sup> using ACR data mapped to EULAR data: linear cDMARD HAQ progression and a moderate, MTX-experienced, RA population

First intervention in the strategy	Discounted costs	Discounted QALYs	CPQ compared with MTX strategy (£)	Incremental CPQ (£)
MTX	CiC information has been removed	CiC information has been removed	–	–
TCZ + MTX	CiC information has been removed	CiC information has been removed	32,540	Extendedly dominated
ABT i.v. + MTX	CiC information has been removed	CiC information has been removed	27,857	27,857
IFX + MTX	CiC information has been removed	CiC information has been removed	28,284	112,265
CTZ + MTX	CiC information has been removed	CiC information has been removed	28,972	Dominated
ABT s.c. + MTX	CiC information has been removed	CiC information has been removed	30,258	Dominated
GOL + MTX	CiC information has been removed	CiC information has been removed	29,952	216,351
ADA + MTX	CiC information has been removed	CiC information has been removed	30,289	Dominated
ETN + MTX	CiC information has been removed	CiC information has been removed	31,287	6,775,191

CPQ, cost per QALY gained.

**TABLE 237** Deterministic results having used discount rates of 6% per annum for costs and 1.5% per annum for QALYs and using ACR data mapped to EULAR data: linear cDMARD HAQ progression and a moderate, MTX-experienced, RA population

First intervention in the strategy	Discounted costs	Discounted QALYs	CPQ compared with MTX strategy (£)	Incremental CPQ (£)
MTX	CiC information has been removed	CiC information has been removed	–	–
TCZ + MTX	CiC information has been removed	CiC information has been removed	20,467	Extendedly dominated
ABT i.v. + MTX	CiC information has been removed	CiC information has been removed	20,373	20,373
IFX + MTX	CiC information has been removed	CiC information has been removed	21,397	144,174
CTZ + MTX	CiC information has been removed	CiC information has been removed	21,831	Dominated
ABT s.c. + MTX	CiC information has been removed	CiC information has been removed	22,822	Dominated
ADA + MTX	CiC information has been removed	CiC information has been removed	22,899	Dominated
GOL + MTX	CiC information has been removed	CiC information has been removed	23,129	Extendedly dominated
ETN + MTX	CiC information has been removed	CiC information has been removed	23,524	264,012

CPQ, cost per QALY gained.

**TABLE 238** Deterministic results assuming 100-fold increased impact of AEs and using ACR data mapped to EULAR data: linear cDMARD HAQ progression and a moderate, MTX-experienced, RA population

First intervention in the strategy	Discounted costs	Discounted QALYs	CPQ compared with MTX strategy (£)	Incremental CPQ (£)
MTX	CiC information has been removed	CiC information has been removed	–	–
TCZ + MTX	CiC information has been removed	CiC information has been removed	38,589	Extendedly dominated
ABT i.v. + MTX	CiC information has been removed	CiC information has been removed	34,339	34,339
IFX + MTX	CiC information has been removed	CiC information has been removed	35,366	153,812
CTZ + MTX	CiC information has been removed	CiC information has been removed	35,983	Dominated
GOL + MTX	CiC information has been removed	CiC information has been removed	37,069	Dominated
ADA + MTX	CiC information has been removed	CiC information has been removed	37,360	Dominated
ABT s.c. + MTX	CiC information has been removed	CiC information has been removed	37,359	Extendedly dominated
ETN + MTX	CiC information has been removed	CiC information has been removed	38,510	239,256

CPQ, cost per QALY gained.

**TABLE 239** Deterministic results having used the relationship between HAQ and pain derived from ERAS: linear cDMARD HAQ progression and a moderate, MTX-experienced, RA population

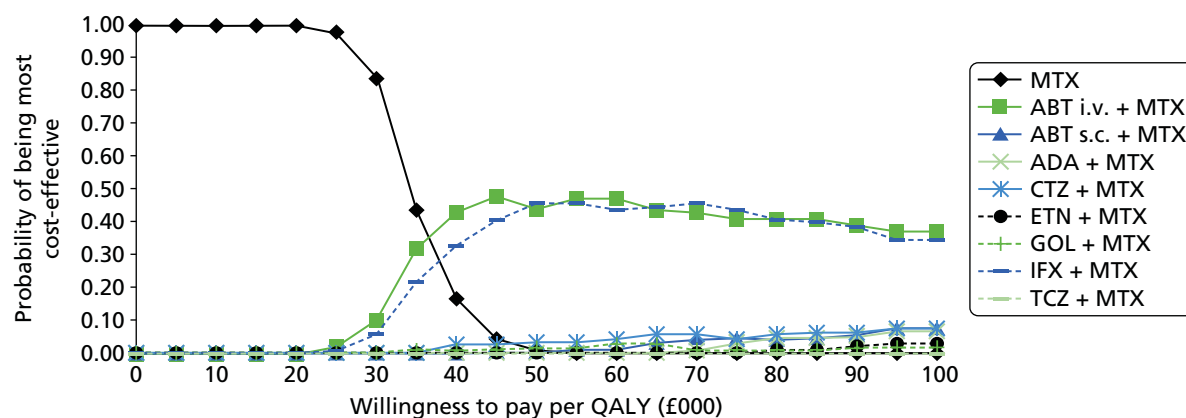
First intervention in the strategy	Discounted costs	Discounted QALYs	CPQ compared with MTX strategy (£)	Incremental CPQ (£)
MTX	CiC information has been removed	CiC information has been removed	–	–
TCZ + MTX	CiC information has been removed	CiC information has been removed	48,514	Extendedly dominated
ABT i.v. + MTX	CiC information has been removed	CiC information has been removed	42,655	42,655
IFX + MTX	CiC information has been removed	CiC information has been removed	43,444	198,638
CTZ + MTX	CiC information has been removed	CiC information has been removed	45,289	Dominated
ADA + MTX	CiC information has been removed	CiC information has been removed	46,863	Dominated
GOL + MTX	CiC information has been removed	CiC information has been removed	46,719	Extendedly dominated
ABT s.c. + MTX	CiC information has been removed	CiC information has been removed	47,094	Extendedly dominated
ETN + MTX	CiC information has been removed	CiC information has been removed	48,243	387,730

CPQ, cost per QALY gained.

**TABLE 240** Probabilistic base-case results using ACR data mapped to EULAR data: linear cDMARD HAQ progression and a moderate, MTX-experienced, RA population

First intervention in the strategy	Discounted costs	Discounted QALYs	CPQ compared with MTX strategy (£)	Incremental CPQ (£)
MTX	CiC information has been removed	CiC information has been removed	–	–
TCZ + MTX	CiC information has been removed	CiC information has been removed	40,241	Extendedly dominated
ABT i.v. + MTX	CiC information has been removed	CiC information has been removed	35,088	35,088
IFX + MTX	CiC information has been removed	CiC information has been removed	35,318	70,967
CTZ + MTX	CiC information has been removed	CiC information has been removed	36,970	Dominated
ABT s.c. + MTX	CiC information has been removed	CiC information has been removed	38,183	Extendedly dominated
GOL + MTX	CiC information has been removed	CiC information has been removed	38,412	Extendedly dominated
ADA + MTX	CiC information has been removed	CiC information has been removed	38,369	Extendedly dominated
ETN + MTX	CiC information has been removed	CiC information has been removed	39,754	340,953

CPQ, cost per QALY gained.



**FIGURE 126** The CEAC using ACR data mapped to EULAR data and assuming linear CDMARD HAQ progression and a moderate, MTX-experienced, RA population.

### European League Against Rheumatism response measure: Early Rheumatoid Arthritis Study cDMARD Health Assessment Questionnaire progression and a severe, methotrexate-experienced, rheumatoid arthritis population treated with monotherapy

The base-case results for this population and those from sensitivity analyses are provided in Tables 241–247. The CEAC for the base case is shown in Figure 127.

It is seen that the ICERs of all the bDMARDs compared with the MTX strategy are in the region of £46,000–49,000.

It is seen that at a willingness to pay of £30,000 the SSZ strategy has a very high probability of being optimal.

**TABLE 241** Deterministic base-case results using EULAR data directly: ERAS cDMARD HAQ progression and a severe, MTX-experienced, RA population treated with monotherapy

First intervention in the strategy	Discounted costs	Discounted QALYs	CPQ compared with MTX strategy (£)	Incremental CPQ (£)
SSZ	CiC information has been removed	CiC information has been removed	–	–
ADA	CiC information has been removed	CiC information has been removed	48,306	Extendedly dominated
ETN	CiC information has been removed	CiC information has been removed	48,528	Extendedly dominated
TCZ	CiC information has been removed	CiC information has been removed	46,327	46,327

CPQ, cost per QALY gained.

**TABLE 242** Deterministic results having included RCTs with a small proportion of previous bDMARD use (with adequate prior MTX exposure) using EULAR data directly: ERAS cDMARD HAQ progression and a severe, MTX-experienced, RA population treated with monotherapy

First intervention in the strategy	Discounted costs	Discounted QALYs	CPQ compared with MTX strategy (£)	Incremental CPQ (£)
SSZ	CiC information has been removed	CiC information has been removed	–	–
ADA	CiC information has been removed	CiC information has been removed	49,001	Extendedly dominated
ETN	CiC information has been removed	CiC information has been removed	49,084	Extendedly dominated
TCZ	CiC information has been removed	CiC information has been removed	46,660	46,660

CPQ, cost per QALY gained.

**TABLE 243** Deterministic results having used the mapping of HAQ to utility from Malottki *et al.*<sup>171</sup> rather than Hernandez-Alava *et al.*<sup>276</sup> using EULAR data directly: ERAS cDMARD HAQ progression and a severe, MTX-experienced, RA population treated with monotherapy

First intervention in the strategy	Discounted costs	Discounted QALYs	CPQ compared with MTX strategy (£)	Incremental CPQ (£)
SSZ	CiC information has been removed	CiC information has been removed	–	–
ADA	CiC information has been removed	CiC information has been removed	40,230	Extendedly dominated
ETN	CiC information has been removed	CiC information has been removed	40,890	Dominated
TCZ	CiC information has been removed	CiC information has been removed	38,369	38,369

CPQ, cost per QALY gained.

**TABLE 244** Deterministic results having used discount rates of 6% per annum for costs and 1.5% per annum for QALYs and using EULAR data directly: ERAS cDMARD HAQ progression and a severe, MTX-experienced, RA population treated with monotherapy

First intervention in the strategy	Discounted costs	Discounted QALYs	CPQ compared with MTX strategy (£)	Incremental CPQ (£)
SSZ	CiC information has been removed	CiC information has been removed	–	–
ADA	CiC information has been removed	CiC information has been removed	32,747	Extendedly dominated
ETN	CiC information has been removed	CiC information has been removed	33,110	Dominated
TCZ	CiC information has been removed	CiC information has been removed	31,064	31,064

CPQ, cost per QALY gained.



**TABLE 245** Deterministic results assuming 100-fold increased impact of AEs and using EULAR data directly: ERAS cDMARD HAQ progression and a severe, MTX-experienced, RA population treated with monotherapy

First intervention in the strategy	Discounted costs	Discounted QALYs	CPQ compared with MTX strategy (£)	Incremental CPQ (£)
SSZ	CiC information has been removed	CiC information has been removed	–	–
ADA	CiC information has been removed	CiC information has been removed	48,869	Extendedly dominated
ETN	CiC information has been removed	CiC information has been removed	48,917	Extendedly dominated
TCZ	CiC information has been removed	CiC information has been removed	46,797	46,797

CPQ, cost per QALY gained.

**TABLE 246** Deterministic results having used the relationship between HAQ and pain derived from ERAS: ERAS cDMARD HAQ progression and a severe, MTX-experienced, RA population treated with monotherapy

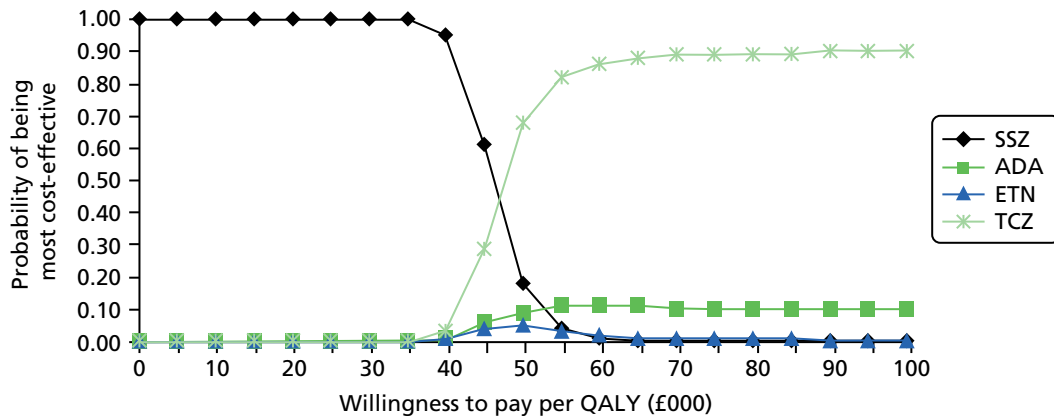
First intervention in the strategy	Discounted costs	Discounted QALYs	CPQ compared with MTX strategy (£)	Incremental CPQ (£)
SSZ	CiC information has been removed	CiC information has been removed	–	–
ADA	CiC information has been removed	CiC information has been removed	58,955	Extendedly dominated
ETN	CiC information has been removed	CiC information has been removed	59,351	Dominated
TCZ	CiC information has been removed	CiC information has been removed	55,361	55,361

CPQ, cost per QALY gained.

**TABLE 247** Probabilistic base-case results using EULAR data directly: ERAS cDMARD HAQ progression and a severe, MTX-experienced, RA population treated with monotherapy

First intervention in the strategy	Discounted costs	Discounted QALYs	CPQ compared with MTX strategy (£)	Incremental CPQ (£)
SSZ	CiC information has been removed	CiC information has been removed	–	–
ADA	CiC information has been removed	CiC information has been removed	48,192	Extendedly dominated
ETN	CiC information has been removed	CiC information has been removed	48,392	Extendedly dominated
TCZ	CiC information has been removed	CiC information has been removed	46,040	46,040

CPQ, cost per QALY gained.



**FIGURE 127** The CEAC when using EULAR data directly: ERAS cDMARD HAQ progression and a severe, MTX-experienced, RA population treated with monotherapy.

**European League Against Rheumatism response measure: linear cDMARD Health Assessment Questionnaire progression and a severe, methotrexate-experienced, rheumatoid arthritis population treated with monotherapy**

The base-case results for this population and those from sensitivity analyses are provided in Tables 248–254. The CEAC for the base case is shown in Figure 128.

It is seen that the ICERs of all the bDMARDs compared with the MTX strategy are in the region of £39,000–40,000.

It is seen that at a willingness to pay of £30,000 the SSZ strategy has a very high probability of being optimal.

**TABLE 248** Deterministic base-case results using EULAR data directly: linear cDMARD HAQ progression and a severe, MTX-experienced, RA population treated with monotherapy

First intervention in the strategy	Discounted costs	Discounted QALYs	CPQ compared with MTX strategy (£)	Incremental CPQ (£)
SSZ	CiC information has been removed	CiC information has been removed	–	–
ADA	CiC information has been removed	CiC information has been removed	39,171	39,171
ETN	CiC information has been removed	CiC information has been removed	39,637	Dominated
TCZ	CiC information has been removed	CiC information has been removed	39,654	43,846

CPQ, cost per QALY gained.

**TABLE 249** Deterministic results having included RCTs with a small proportion of previous bDMARD use (with adequate prior MTX exposure) using EULAR data directly: linear cDMARD HAQ progression and a severe, MTX-experienced, RA population treated with monotherapy

First intervention in the strategy	Discounted costs	Discounted QALYs	CPQ compared with MTX strategy (£)	Incremental CPQ (£)
SSZ	CiC information has been removed	CiC information has been removed	–	–
ADA	CiC information has been removed	CiC information has been removed	37,799	37,799
ETN	CiC information has been removed	CiC information has been removed	37,975	Dominated
TCZ	CiC information has been removed	CiC information has been removed	38,558	44,689

CPQ, cost per QALY gained.

**TABLE 250** Deterministic results having used the mapping of HAQ to utility from Malottki *et al.*<sup>171</sup> rather than Hernandez-Alava *et al.*<sup>276</sup> using EULAR data directly: linear cDMARD HAQ progression and a severe, MTX-experienced, RA population treated with monotherapy

First intervention in the strategy	Discounted costs	Discounted QALYs	CPQ compared with MTX strategy (£)	Incremental CPQ (£)
SSZ	CiC information has been removed	CiC information has been removed	–	–
ADA	CiC information has been removed	CiC information has been removed	34,836	Extendedly dominated
ETN	CiC information has been removed	CiC information has been removed	34,997	Extendedly dominated
TCZ	CiC information has been removed	CiC information has been removed	34,565	34,565

CPQ, cost per QALY gained.

**TABLE 251** Deterministic results having used discount rates of 6% per annum for costs and 1.5% per annum for QALYs and using EULAR data directly: linear cDMARD HAQ progression and a severe, MTX-experienced, RA population treated with monotherapy

First intervention in the strategy	Discounted costs	Discounted QALYs	CPQ compared with MTX strategy (£)	Incremental CPQ (£)
SSZ	CiC information has been removed	CiC information has been removed	–	–
ADA	CiC information has been removed	CiC information has been removed	24,632	24,632
ETN	CiC information has been removed	CiC information has been removed	24,789	Dominated
TCZ	CiC information has been removed	CiC information has been removed	24,770	26,079

CPQ, cost per QALY gained.

**TABLE 252** Deterministic results assuming 100-fold increased impact of AEs and using EULAR data directly: linear cDMARD HAQ progression and a severe, MTX-experienced, RA population treated with monotherapy

First intervention in the strategy	Discounted costs	Discounted QALYs	CPQ compared with MTX strategy (£)	Incremental CPQ (£)
SSZ	CiC information has been removed	CiC information has been removed	–	–
ADA	CiC information has been removed	CiC information has been removed	40,074	40,074
ETN	CiC information has been removed	CiC information has been removed	40,207	Extendedly dominated
TCZ	CiC information has been removed	CiC information has been removed	40,337	42,432

CPQ, cost per QALY gained.

**TABLE 253** Deterministic results having used the relationship between HAQ and pain derived from ERAS: linear cDMARD HAQ progression and a severe, MTX-experienced, RA population treated with monotherapy

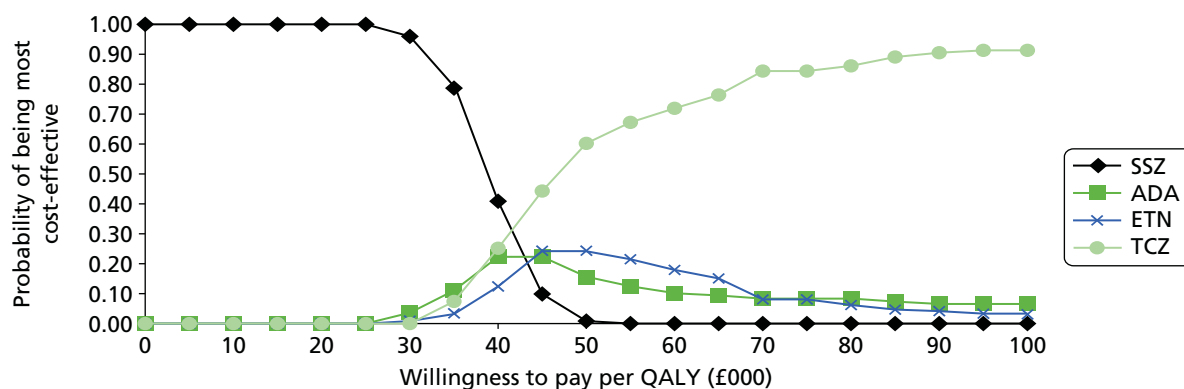
First intervention in the strategy	Discounted costs	Discounted QALYs	CPQ compared with MTX strategy (£)	Incremental CPQ (£)
SSZ	CiC information has been removed	CiC information has been removed	–	–
ADA	CiC information has been removed	CiC information has been removed	49,152	Extendedly dominated
ETN	CiC information has been removed	CiC information has been removed	49,716	Extendedly dominated
TCZ	CiC information has been removed	CiC information has been removed	49,145	49,145

CPQ, cost per QALY gained.

**TABLE 254** Probabilistic base-case results using EULAR data directly: linear cDMARD HAQ progression and a severe, MTX-experienced, RA population treated with monotherapy

First intervention in the strategy	Discounted costs	Discounted QALYs	CPQ compared with MTX strategy (£)	Incremental CPQ (£)
SSZ	CiC information has been removed	CiC information has been removed	–	–
ADA	CiC information has been removed	CiC information has been removed	38,806	38,806
ETN	CiC information has been removed	CiC information has been removed	39,132	Dominated
TCZ	CiC information has been removed	CiC information has been removed	39,115	41,651

CPQ, cost per QALY gained.



**FIGURE 128** The CEAC when using EULAR data directly: linear cDMARD HAQ progression and a severe, MTX-experienced, RA population treated with monotherapy.

### American College of Rheumatology response measure: Early Rheumatoid Arthritis Study cDMARD Health Assessment Questionnaire progression and a severe, methotrexate-experienced, rheumatoid arthritis population treated with monotherapy

The base-case results for this population and those from sensitivity analyses are provided in *Tables 255–266*. The CEAC for the base case is shown in *Figure 129*.

It is seen that the ICERs of all the bDMARDs compared with the MTX strategy are in the region of £49,000–50,000.

It is seen that at a willingness to pay of £30,000 the SSZ strategy has a very high probability of being optimal.

**TABLE 255** Deterministic base-case results mapping EULAR data from ACR data: ERAS cDMARD HAQ progression and a severe, MTX-experienced, RA population treated with monotherapy

First intervention in the strategy	Discounted costs	Discounted QALYs	CPQ compared with MTX strategy (£)	Incremental CPQ (£)
SSZ	CiC information has been removed	CiC information has been removed	–	–
ADA	CiC information has been removed	CiC information has been removed	49,707	Extendedly dominated
ETN	CiC information has been removed	CiC information has been removed	49,808	Extendedly dominated
TCZ	CiC information has been removed	CiC information has been removed	49,584	49,584

CPQ, cost per QALY gained.

**TABLE 256** Deterministic results having included RCTs with a small proportion of previous bDMARD use (with adequate prior MTX exposure) mapping EULAR data from ACR data: ERAS cDMARD HAQ progression and a severe, MTX-experienced, RA population treated with monotherapy

First intervention in the strategy	Discounted costs	Discounted QALYs	CPQ compared with MTX strategy (£)	Incremental CPQ (£)
SSZ	CiC information has been removed	CiC information has been removed	–	–
ETN	CiC information has been removed	CiC information has been removed	49,550	Extendedly dominated
ADA	CiC information has been removed	CiC information has been removed	49,484	Extendedly dominated
TCZ	CiC information has been removed	CiC information has been removed	49,394	49,394

CPQ, cost per QALY gained.

**TABLE 257** Deterministic results having included RCTs with a small proportion of previous bDMARD use (irrespective of prior MTX exposure) mapping EULAR data from ACR data: ERAS cDMARD HAQ progression and a severe, MTX-experienced, RA population treated with monotherapy

First intervention in the strategy	Discounted costs	Discounted QALYs	CPQ compared with MTX strategy (£)	Incremental CPQ (£)
SSZ	CiC information has been removed	CiC information has been removed	–	–
ETN	CiC information has been removed	CiC information has been removed	49,473	Extendedly dominated
ADA	CiC information has been removed	CiC information has been removed	49,953	Dominated
TCZ	CiC information has been removed	CiC information has been removed	49,169	49,169

CPQ, cost per QALY gained.

**TABLE 258** Deterministic results having included RCTs with potentially low prior MTX exposure using ACR data mapped to EULAR data: ERAS cDMARD HAQ progression and a severe, MTX-experienced, RA population treated with monotherapy

First intervention in the strategy	Discounted costs	Discounted QALYs	CPQ compared with MTX strategy (£)	Incremental CPQ (£)
SSZ	CiC information has been removed	CiC information has been removed	–	–
ADA	CiC information has been removed	CiC information has been removed	49,983	Extendedly dominated
ETN	CiC information has been removed	CiC information has been removed	50,384	Dominated
TCZ	CiC information has been removed	CiC information has been removed	49,546	49,546

CPQ, cost per QALY gained.

**TABLE 259** Deterministic results having used the mapping of HAQ to utility from Malottki *et al.*<sup>171</sup> rather than Hernandez-Alava *et al.*<sup>276</sup> mapping EULAR data from ACR data: ERAS cDMARD HAQ progression and a severe, MTX-experienced, RA population treated with monotherapy

First intervention in the strategy	Discounted costs	Discounted QALYs	CPQ compared with MTX strategy (£)	Incremental CPQ (£)
SSZ	CiC information has been removed	CiC information has been removed	–	–
ADA	CiC information has been removed	CiC information has been removed	41,558	Extendedly dominated
ETN	CiC information has been removed	CiC information has been removed	41,409	Extendedly dominated
TCZ	CiC information has been removed	CiC information has been removed	41,007	41,007

CPQ, cost per QALY gained.

**TABLE 260** Deterministic results having used discount rates of 6% per annum for costs and 1.5% per annum for QALYs and mapping EULAR data from ACR data: ERAS cDMARD HAQ progression and a severe, MTX-experienced, RA population treated with monotherapy

First intervention in the strategy	Discounted costs	Discounted QALYs	CPQ compared with MTX strategy (£)	Incremental CPQ (£)
SSZ	CiC information has been removed	CiC information has been removed	–	–
ADA	CiC information has been removed	CiC information has been removed	41,558	Extendedly dominated
ETN	CiC information has been removed	CiC information has been removed	41,409	Extendedly dominated
TCZ	CiC information has been removed	CiC information has been removed	41,007	41,007

CPQ, cost per QALY gained.

**TABLE 261** Deterministic results assuming 100-fold increased impact of AEs and mapping EULAR data from ACR data: ERAS cDMARD HAQ progression and a severe, MTX-experienced, RA population treated with monotherapy

First intervention in the strategy	Discounted costs	Discounted QALYs	CPQ compared with MTX strategy (£)	Incremental CPQ (£)
SSZ	CiC information has been removed	CiC information has been removed	–	–
ETN	CiC information has been removed	CiC information has been removed	50,272	Extendedly dominated
ADA	CiC information has been removed	CiC information has been removed	50,135	Extendedly dominated
TCZ	CiC information has been removed	CiC information has been removed	49,575	49,575

CPQ, cost per QALY gained.

**TABLE 262** Deterministic results having used the relationship between HAQ and pain derived from ERAS: ERAS cDMARD HAQ progression and a severe, MTX-experienced, RA population treated with monotherapy

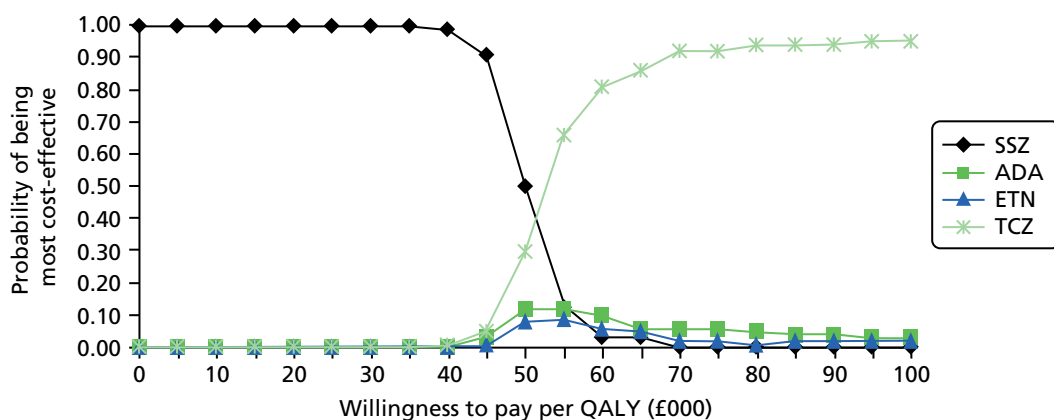
First intervention in the strategy	Discounted costs	Discounted QALYs	CPQ compared with MTX strategy (£)	Incremental CPQ (£)
SSZ	CiC information has been removed	CiC information has been removed	–	–
ADA	CiC information has been removed	CiC information has been removed	60,418	Extendedly dominated
ETN	CiC information has been removed	CiC information has been removed	60,704	Dominated
TCZ	CiC information has been removed	CiC information has been removed	60,386	60,386

CPQ, cost per QALY gained.

**TABLE 263** Probabilistic base-case results mapping EULAR data from ACR data: ERAS cDMARD HAQ progression and a severe, MTX-experienced, RA population treated with monotherapy

First intervention in the strategy	Discounted costs	Discounted QALYs	CPQ compared with MTX strategy (£)	Incremental CPQ (£)
SSZ	CiC information has been removed	CiC information has been removed	–	–
ETN	CiC information has been removed	CiC information has been removed	50,272	Extendedly dominated
ADA	CiC information has been removed	CiC information has been removed	50,135	Extendedly dominated
TCZ	CiC information has been removed	CiC information has been removed	49,575	49,899

CPQ, cost per QALY gained.



**FIGURE 129** The CEAC when mapping EULAR data from ACR data: ERAS cDMARD HAQ progression and a severe, MTX-experienced, RA population treated with monotherapy.



### American College of Rheumatology response measure: linear cDMARD Health Assessment Questionnaire progression and a severe, methotrexate-experienced, rheumatoid arthritis population treated with monotherapy

The base-case results for this population and those from sensitivity analyses are provided in Tables 264–272. The CEAC for the base case is shown in Figure 130.

It is seen that the ICERs of all the bDMARDs compared with the MTX strategy are in the region of £38,000–41,000.

It is seen that at a willingness to pay of £30,000 the SSZ strategy and the TCZ strategy have reasonably high probabilities of being optimal.

**TABLE 264** Deterministic base-case results mapping EULAR data from ACR data: linear cDMARD HAQ progression and a severe, MTX-experienced, RA population treated with monotherapy

First intervention in the strategy	Discounted costs	Discounted QALYs	CPQ compared with MTX strategy (£)	Incremental CPQ (£)
SSZ	CiC information has been removed	CiC information has been removed	–	–
ADA	CiC information has been removed	CiC information has been removed	38,501	38,501
ETN	CiC information has been removed	CiC information has been removed	38,547	49,828
TCZ	CiC information has been removed	CiC information has been removed	40,049	70,054

CPQ, cost per QALY gained.

**TABLE 265** Deterministic results having included RCTs with a small proportion of previous bDMARD use (with adequate prior MTX exposure) mapping EULAR data from ACR data: linear cDMARD HAQ progression and a severe, MTX-experienced, RA population treated with monotherapy

First intervention in the strategy	Discounted costs	Discounted QALYs	CPQ compared with MTX strategy (£)	Incremental CPQ (£)
SSZ	CiC information has been removed	CiC information has been removed	–	–
ETN	CiC information has been removed	CiC information has been removed	37,261	Extendedly dominated
ADA	CiC information has been removed	CiC information has been removed	37,343	37,261
TCZ	CiC information has been removed	CiC information has been removed	38,835	66,329

CPQ, cost per QALY gained.

**TABLE 266** Deterministic results having included RCTs with a small proportion of previous bDMARD use (irrespective of prior MTX exposure) mapping EULAR data from ACR data: linear cDMARD HAQ progression and a severe, MTX-experienced, RA population treated with monotherapy

First intervention in the strategy	Discounted costs	Discounted QALYs	CPQ compared with MTX strategy (£)	Incremental CPQ (£)
SSZ	CiC information has been removed	CiC information has been removed	–	–
ADA	CiC information has been removed	CiC information has been removed	37,185	Extendedly dominated
ETN	CiC information has been removed	CiC information has been removed	37,087	37,087
TCZ	CiC information has been removed	CiC information has been removed	38,562	67,396

CPQ, cost per QALY gained.

**TABLE 267** Deterministic results having included RCTs with potentially low prior MTX exposure using ACR data mapped to EULAR data: linear cDMARD HAQ progression and a severe, MTX-experienced, RA population treated with monotherapy

First intervention in the strategy	Discounted costs	Discounted QALYs	CPQ compared with MTX strategy (£)	Incremental CPQ (£)
SSZ	CiC information has been removed	CiC information has been removed	–	–
ETN	CiC information has been removed	CiC information has been removed	36,796	36,796
ADA	CiC information has been removed	CiC information has been removed	37,204	Dominated
TCZ	CiC information has been removed	CiC information has been removed	38,432	59,568

CPQ, cost per QALY gained.

**TABLE 268** Deterministic results having used the mapping of HAQ to utility from Malottki *et al.*<sup>171</sup> rather than Hernandez-Alava *et al.*<sup>276</sup> mapping EULAR data from ACR data: linear cDMARD HAQ progression and a severe, MTX-experienced, RA population treated with monotherapy

First intervention in the strategy	Discounted costs	Discounted QALYs	CPQ compared with MTX strategy (£)	Incremental CPQ (£)
SSZ	CiC information has been removed	CiC information has been removed	–	–
ADA	CiC information has been removed	CiC information has been removed	34,042	34,042
ETN	CiC information has been removed	CiC information has been removed	34,055	49,928
TCZ	CiC information has been removed	CiC information has been removed	35,280	55,140

CPQ, cost per QALY gained.

**TABLE 269** Deterministic results having used discount rates of 6% per annum for costs and 1.5% per annum for QALYs and mapping EULAR data from ACR data: linear cDMARD HAQ progression and a severe, MTX-experienced, RA population treated with monotherapy

First intervention in the strategy	Discounted costs	Discounted QALYs	CPQ compared with MTX strategy (£)	Incremental CPQ (£)
SSZ	CiC information has been removed	CiC information has been removed	–	–
ADA	CiC information has been removed	CiC information has been removed	23,591	Extendedly dominated
ETN	CiC information has been removed	CiC information has been removed	23,537	23,537
TCZ	CiC information has been removed	CiC information has been removed	24,343	39,745

CPQ, cost per QALY gained.

**TABLE 270** Deterministic results assuming 100-fold increased impact of AEs and mapping EULAR data from ACR data: linear cDMARD HAQ progression and a severe, MTX-experienced, RA population treated with monotherapy

First intervention in the strategy	Discounted costs	Discounted QALYs	CPQ compared with MTX strategy (£)	Incremental CPQ (£)
SSZ	CiC information has been removed	CiC information has been removed	–	–
ADA	CiC information has been removed	CiC information has been removed	39,173	39,173
ETN	CiC information has been removed	CiC information has been removed	39,257	59,684
TCZ	CiC information has been removed	CiC information has been removed	40,674	65,518

CPQ, cost per QALY gained.

**TABLE 271** Deterministic results having used the relationship between HAQ and pain derived from ERAS: linear cDMARD HAQ progression and a severe, MTX-experienced, RA population treated with monotherapy

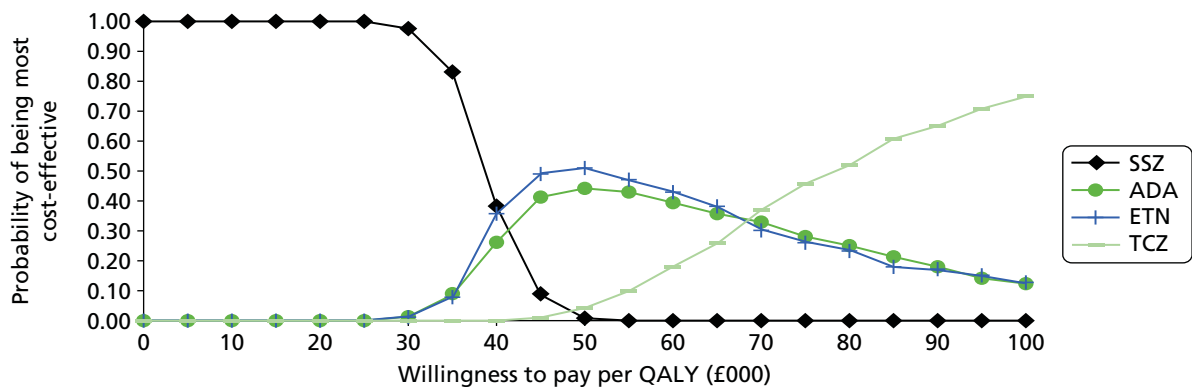
First intervention in the strategy	Discounted costs	Discounted QALYs	CPQ compared with MTX strategy (£)	Incremental CPQ (£)
SSZ	CiC information has been removed	CiC information has been removed	–	–
ADA	CiC information has been removed	CiC information has been removed	47,732	47,732
ETN	CiC information has been removed	CiC information has been removed	47,801	73,402
TCZ	CiC information has been removed	CiC information has been removed	49,552	78,345

CPQ, cost per QALY gained.

**TABLE 272** Probabilistic base-case results mapping EULAR data from ACR data: linear cDMARD HAQ progression and a severe, MTX-experienced, RA population treated with monotherapy

First intervention in the strategy	Discounted costs	Discounted QALYs	CPQ compared with MTX strategy (£)	Incremental CPQ (£)
SSZ	CiC information has been removed	CiC information has been removed	–	–
ETN	CiC information has been removed	CiC information has been removed	38,765	38,765
ADA	CiC information has been removed	CiC information has been removed	38,766	Dominated
TCZ	CiC information has been removed	CiC information has been removed	40,229	70,551

CPQ, cost per QALY gained.



**FIGURE 130** The CEAC when mapping EULAR data from ACR data: linear cDMARD HAQ progression and a severe, MTX-experienced, RA population treated with monotherapy.

**European League Against Rheumatism response measure: Early Rheumatoid Arthritis Study cDMARD Health Assessment Questionnaire progression and a moderate, methotrexate-experienced, rheumatoid arthritis population treated with monotherapy**

The base-case results for this population and those from sensitivity analyses are provided in Tables 273–279. The CEAC for the base case is shown in Figure 131.

It is seen that the ICERs of all the bDMARDs compared with the MTX strategy are in the region of £58,000–60,000.

It is seen that at a willingness to pay of £30,000 the SSZ strategy has a very high probability of being optimal.

**TABLE 273** Deterministic base-case results using EULAR data directly: ERAS cDMARD HAQ progression and a moderate, MTX-experienced, RA population treated with monotherapy

First intervention in the strategy	Discounted costs	Discounted QALYs	CPQ compared with MTX strategy (£)	Incremental CPQ (£)
SSZ	CiC information has been removed	CiC information has been removed	–	–
ETN	CiC information has been removed	CiC information has been removed	59,036	Extendedly dominated
CTZ	CiC information has been removed	CiC information has been removed	58,798	Extendedly dominated
TCZ	CiC information has been removed	CiC information has been removed	58,673	58,673

CPQ, cost per QALY gained.

**TABLE 274** Deterministic results having included RCTs with a small proportion of previous bDMARD use (with adequate prior MTX exposure) using EULAR data directly: ERAS cDMARD HAQ progression and a moderate, MTX-experienced, RA population treated with monotherapy

First intervention in the strategy	Discounted costs	Discounted QALYs	CPQ compared with MTX strategy (£)	Incremental CPQ (£)
SSZ	CiC information has been removed	CiC information has been removed	–	–
ADA	CiC information has been removed	CiC information has been removed	55,934	Extendedly dominated
ETN	CiC information has been removed	CiC information has been removed	57,588	Extendedly dominated
TCZ	CiC information has been removed	CiC information has been removed	55,364	55,364

CPQ, cost per QALY gained.

**TABLE 275** Deterministic results having used the mapping of HAQ to utility from Malottki *et al.*<sup>171</sup> rather than Hernandez-Alava *et al.*<sup>276</sup> using EULAR data directly: ERAS cDMARD HAQ progression and a moderate, MTX-experienced, RA population treated with monotherapy

First intervention in the strategy	Discounted costs	Discounted QALYs	CPQ compared with MTX strategy (£)	Incremental CPQ (£)
SSZ	CiC information has been removed	CiC information has been removed	–	–
ETN	CiC information has been removed	CiC information has been removed	42,028	Extendedly dominated
ADA	CiC information has been removed	CiC information has been removed	41,852	Extendedly dominated
TCZ	CiC information has been removed	CiC information has been removed	40,433	40,433

CPQ, cost per QALY gained.

**TABLE 276** Deterministic results having used discount rates of 6% per annum for costs and 1.5% per annum for QALYs and using EULAR data directly: ERAS cDMARD HAQ progression and a moderate, MTX-experienced, RA population treated with monotherapy

First intervention in the strategy	Discounted costs	Discounted QALYs	CPQ compared with MTX strategy (£)	Incremental CPQ (£)
SSZ	CiC information has been removed	CiC information has been removed	–	–
ETN	CiC information has been removed	CiC information has been removed	39,090	Extendedly dominated
ADA	CiC information has been removed	CiC information has been removed	37,482	Extendedly dominated
TCZ	CiC information has been removed	CiC information has been removed	35,952	35,952

CPQ, cost per QALY gained.

**TABLE 277** Deterministic results assuming 100-fold increased impact of AEs and using EULAR data directly: ERAS cDMARD HAQ progression and a moderate, MTX-experienced, RA population treated with monotherapy

First intervention in the strategy	Discounted costs	Discounted QALYs	CPQ compared with MTX strategy (£)	Incremental CPQ (£)
SSZ	CiC information has been removed	CiC information has been removed	–	–
ADA	CiC information has been removed	CiC information has been removed	59,928	Extendedly dominated
ETN	CiC information has been removed	CiC information has been removed	59,443	Extendedly dominated
TCZ	CiC information has been removed	CiC information has been removed	58,291	58,291

CPQ, cost per QALY gained.

**TABLE 278** Deterministic results having used the relationship between HAQ and pain derived from ERAS: ERAS cDMARD HAQ progression and a moderate, MTX-experienced, RA population treated with monotherapy

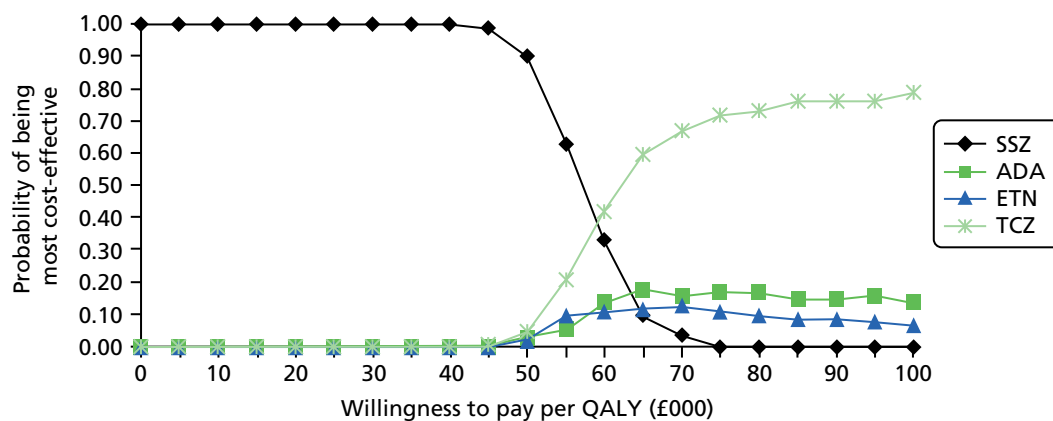
First intervention in the strategy	Discounted costs	Discounted QALYs	CPQ compared with MTX strategy (£)	Incremental CPQ (£)
SSZ	CiC information has been removed	CiC information has been removed	–	–
ETN	CiC information has been removed	CiC information has been removed	67,022	Extendedly dominated
ADA	CiC information has been removed	CiC information has been removed	66,067	Extendedly dominated
TCZ	CiC information has been removed	CiC information has been removed	63,456	63,456

CPQ, cost per QALY gained.

**TABLE 279** Probabilistic base-case results using EULAR data directly: ERAS cDMARD HAQ progression and a moderate, MTX-experienced, RA population treated with monotherapy

First intervention in the strategy	Discounted costs	Discounted QALYs	CPQ compared with MTX strategy (£)	Incremental CPQ (£)
SSZ	CiC information has been removed	CiC information has been removed	–	–
ADA	CiC information has been removed	CiC information has been removed	59,657	Extendedly dominated
ETN	CiC information has been removed	CiC information has been removed	59,719	Extendedly dominated
TCZ	CiC information has been removed	CiC information has been removed	57,809	57,809

CPQ, cost per QALY gained.

**FIGURE 131** The CEAC when using EULAR data directly: ERAS cDMARD HAQ progression and a moderate, MTX-experienced, RA population treated with monotherapy.

### European League Against Rheumatism response measure: linear cDMARD Health Assessment Questionnaire progression and a moderate, methotrexate-experienced, rheumatoid arthritis population treated with monotherapy

The base-case results for this population and those from sensitivity analyses are provided in Tables 280–286. The CEAC for the base case is shown in Figure 132.

It is seen that the ICERs of all the bDMARDs compared with the MTX strategy are in the region of £41,000–43,000.

It is seen that at a willingness to pay of £30,000 the SSZ strategy has a high probability of being optimal.

**TABLE 280** Deterministic base-case results using EULAR data directly: linear cDMARD HAQ progression and a severe, MTX-experienced, RA population treated with monotherapy

First intervention in the strategy	Discounted costs	Discounted QALYs	CPQ compared with MTX strategy (£)	Incremental CPQ (£)
SSZ	CiC information has been removed	CiC information has been removed	–	–
ADA	CiC information has been removed	CiC information has been removed	41,190	41,190
ETN	CiC information has been removed	CiC information has been removed	41,385	Extendedly dominated
TCZ	CiC information has been removed	CiC information has been removed	42,465	54,415

CPQ, cost per QALY gained.

**TABLE 281** Deterministic results having included RCTs with a small proportion of previous bDMARD use (with adequate prior MTX exposure) using EULAR data directly: linear cDMARD HAQ progression and a severe, MTX-experienced, RA population treated with monotherapy

First intervention in the strategy	Discounted costs	Discounted QALYs	CPQ compared with MTX strategy (£)	Incremental CPQ (£)
SSZ	CiC information has been removed	CiC information has been removed	–	–
ADA	CiC information has been removed	CiC information has been removed	38,937	38,937
ETN	CiC information has been removed	CiC information has been removed	39,300	Extendedly dominated
TCZ	CiC information has been removed	CiC information has been removed	41,020	61,560

CPQ, cost per QALY gained.

**TABLE 282** Deterministic results having used the mapping of HAQ to utility from Malottki *et al.*<sup>171</sup> rather than Hernandez-Alava *et al.*<sup>276</sup> using EULAR data directly: linear cDMARD HAQ progression and a severe, MTX-experienced, RA population treated with monotherapy

First intervention in the strategy	Discounted costs	Discounted QALYs	CPQ compared with MTX strategy (£)	Incremental CPQ (£)
SSZ	CiC information has been removed	CiC information has been removed	–	–
ADA	CiC information has been removed	CiC information has been removed	32,767	Extendedly dominated
ETN	CiC information has been removed	CiC information has been removed	32,872	Extendedly dominated
TCZ	CiC information has been removed	CiC information has been removed	32,465	29,207

CPQ, cost per QALY gained.



**TABLE 283** Deterministic results having used discount rates of 6% per annum for costs and 1.5% per annum for QALYs and using EULAR data directly: linear cDMARD HAQ progression and a severe, MTX-experienced, RA population treated with monotherapy

First intervention in the strategy	Discounted costs	Discounted QALYs	CPQ compared with MTX strategy (£)	Incremental CPQ (£)
SSZ	CiC information has been removed	CiC information has been removed	–	–
ADA	CiC information has been removed	CiC information has been removed	23,671	23,671
ETN	CiC information has been removed	CiC information has been removed	23,869	Extendedly dominated
TCZ	CiC information has been removed	CiC information has been removed	24,469	32,344

CPQ, cost per QALY gained.

**TABLE 284** Deterministic results assuming 100-fold increased impact of AEs and using EULAR data directly: LINEAR cDMARD HAQ progression and a severe, MTX-experienced, RA population treated with monotherapy

First intervention in the strategy	Discounted costs	Discounted QALYs	CPQ compared with MTX strategy (£)	Incremental CPQ (£)
SSZ	CiC information has been removed	CiC information has been removed	–	–
ADA	CiC information has been removed	CiC information has been removed	41,580	41,580
ETN	CiC information has been removed	CiC information has been removed	41,621	Extendedly dominated
TCZ	CiC information has been removed	CiC information has been removed	43,376	60,121

CPQ, cost per QALY gained.

**TABLE 285** Deterministic results having used the relationship between HAQ and pain derived from ERAS: linear cDMARD HAQ progression and a severe, MTX-experienced, RA population treated with monotherapy

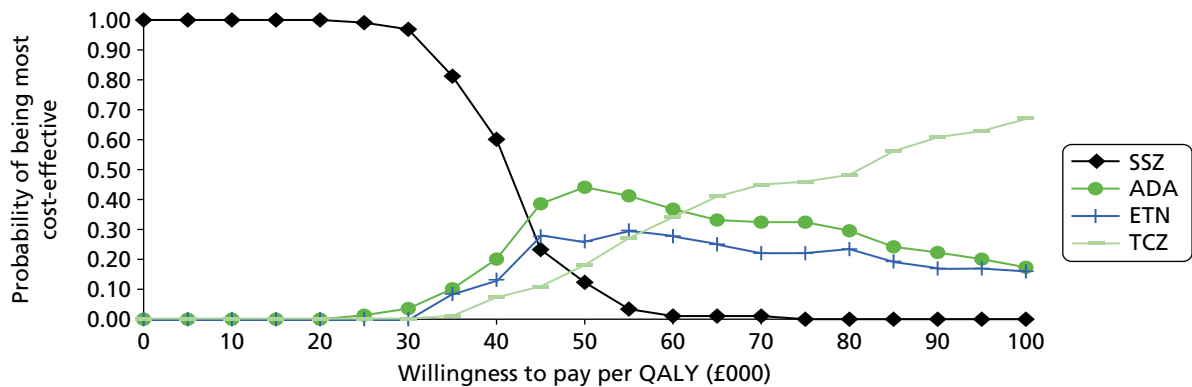
First intervention in the strategy	Discounted costs	Discounted QALYs	CPQ compared with MTX strategy (£)	Incremental CPQ (£)
SSZ	CiC information has been removed	CiC information has been removed	–	–
ADA	CiC information has been removed	CiC information has been removed	48,834	48,834
ETN	CiC information has been removed	CiC information has been removed	49,661	Extendedly dominated
TCZ	CiC information has been removed	CiC information has been removed	50,440	65,894

CPQ, cost per QALY gained.

**TABLE 286** Probabilistic base-case results using EULAR data directly: linear cDMARD HAQ progression and a severe, MTX-experienced, RA population treated with monotherapy

First intervention in the strategy	Discounted costs	Discounted QALYs	CPQ compared with MTX strategy (£)	Incremental CPQ (£)
SSZ	CiC information has been removed	CiC information has been removed	–	–
ADA	CiC information has been removed	CiC information has been removed	41,263	41,263
ETN	CiC information has been removed	CiC information has been removed	41,683	Extendedly dominated
TCZ	CiC information has been removed	CiC information has been removed	43,062	62,038

CPQ, cost per QALY gained.



**FIGURE 132** The CEAC when using EULAR data directly: linear cDMARD HAQ progression and a severe, MTX-experienced, RA population treated with monotherapy.

**American College of Rheumatology response measure: Early Rheumatoid Arthritis Study cDMARD Health Assessment Questionnaire progression and a moderate, methotrexate-experienced, rheumatoid arthritis population treated with monotherapy**

The base-case results for this population and those from sensitivity analyses are provided in Tables 287–295. The CEAC for the base case is shown in Figure 133.

It is seen that the ICERs of all the bDMARDs compared with the MTX strategy are in the region of £57,000–59,000.

It is seen that at a willingness to pay of £30,000 the SSZ strategy has a very high probability of being optimal.

**TABLE 287** Deterministic base-case results mapping EULAR data from ACR data: ERAS cDMARD HAQ progression and a moderate, MTX-experienced, RA population treated with monotherapy

First intervention in the strategy	Discounted costs	Discounted QALYs	CPQ compared with MTX strategy (£)	Incremental CPQ (£)
SSZ	CiC information has been removed	CiC information has been removed	–	–
ADA	CiC information has been removed	CiC information has been removed	58,981	Extendedly dominated
ETN	CiC information has been removed	CiC information has been removed	57,264	57,264
TCZ	CiC information has been removed	CiC information has been removed	57,786	62,823

CPQ, cost per QALY gained.

**TABLE 288** Deterministic results having included RCTs with a small proportion of previous bDMARD use (with adequate prior MTX exposure) mapping EULAR data from ACR data: ERAS cDMARD HAQ progression and a moderate, MTX-experienced, RA population treated with monotherapy

First intervention in the strategy	Discounted costs	Discounted QALYs	CPQ compared with MTX strategy (£)	Incremental CPQ (£)
SSZ	CiC information has been removed	CiC information has been removed	–	–
ETN	CiC information has been removed	CiC information has been removed	58,346	58,346
ADA	CiC information has been removed	CiC information has been removed	59,145	Dominated
TCZ	CiC information has been removed	CiC information has been removed	59,533	77,492

CPQ, cost per QALY gained.

**TABLE 289** Deterministic results having included RCTs with a small proportion of previous bDMARD use (irrespective of prior MTX exposure) mapping EULAR data from ACR data: ERAS cDMARD HAQ progression and a moderate, MTX-experienced, RA population treated with monotherapy

First intervention in the strategy	Discounted costs	Discounted QALYs	CPQ compared with MTX strategy (£)	Incremental CPQ (£)
SSZ	CiC information has been removed	CiC information has been removed	–	–
ADA	CiC information has been removed	CiC information has been removed	62,630	Extendedly dominated
ETN	CiC information has been removed	CiC information has been removed	62,393	Extendedly dominated
TCZ	CiC information has been removed	CiC information has been removed	62,210	62,210

CPQ, cost per QALY gained.

**TABLE 290** Deterministic results having included RCTs with potentially low prior MTX exposure using ACR data mapped to EULAR data: ERAS cDMARD HAQ progression and a moderate, MTX-experienced, RA population treated with monotherapy

First intervention in the strategy	Discounted costs	Discounted QALYs	CPQ compared with MTX strategy (£)	Incremental CPQ (£)
SSZ	CiC information has been removed	CiC information has been removed	–	–
ADA	CiC information has been removed	CiC information has been removed	63,131	Extendedly dominated
ETN	CiC information has been removed	CiC information has been removed	61,889	Extendedly dominated
TCZ	CiC information has been removed	CiC information has been removed	61,577	61,577

CPQ, cost per QALY gained.

**TABLE 291** Deterministic results having used the mapping of HAQ to utility from Malottki *et al.*<sup>171</sup> rather than Hernandez-Alava *et al.*<sup>276</sup> mapping EULAR data from ACR data: ERAS cDMARD HAQ progression and a moderate, MTX-experienced, RA population treated with monotherapy

First intervention in the strategy	Discounted costs	Discounted QALYs	CPQ compared with MTX strategy (£)	Incremental CPQ (£)
SSZ	CiC information has been removed	CiC information has been removed	–	–
ETN	CiC information has been removed	CiC information has been removed	44,867	Extendedly dominated
ADA	CiC information has been removed	CiC information has been removed	44,934	Extendedly dominated
TCZ	CiC information has been removed	CiC information has been removed	44,729	44,729

CPQ, cost per QALY gained.

**TABLE 292** Deterministic results having used discount rates of 6% per annum for costs and 1.5% per annum for QALYs and mapping EULAR data from ACR data: ERAS cDMARD HAQ progression and a moderate, MTX-experienced, RA population treated with monotherapy

First intervention in the strategy	Discounted costs	Discounted QALYs	CPQ compared with MTX strategy (£)	Incremental CPQ (£)
SSZ	CiC information has been removed	CiC information has been removed	–	–
ADA	CiC information has been removed	CiC information has been removed	40,068	Extendedly dominated
ETN	CiC information has been removed	CiC information has been removed	39,282	39,282
TCZ	CiC information has been removed	CiC information has been removed	39,575	44,275

CPQ, cost per QALY gained.

**TABLE 293** Deterministic results assuming 100-fold increased impact of AEs and mapping EULAR data from ACR data: ERAS cDMARD HAQ progression and a moderate, MTX-experienced, RA population treated with monotherapy

First intervention in the strategy	Discounted costs	Discounted QALYs	CPQ compared with MTX strategy (£)	Incremental CPQ (£)
SSZ	CiC information has been removed	CiC information has been removed	–	–
ETN	CiC information has been removed	CiC information has been removed	61,794	Extendedly dominated
ADA	CiC information has been removed	CiC information has been removed	61,928	Extendedly dominated
TCZ	CiC information has been removed	CiC information has been removed	60,755	60,755

CPQ, cost per QALY gained.

**TABLE 294** Deterministic results having used the relationship between HAQ and pain derived from ERAS: ERAS cDMARD HAQ progression and a moderate, MTX-experienced, RA population treated with monotherapy

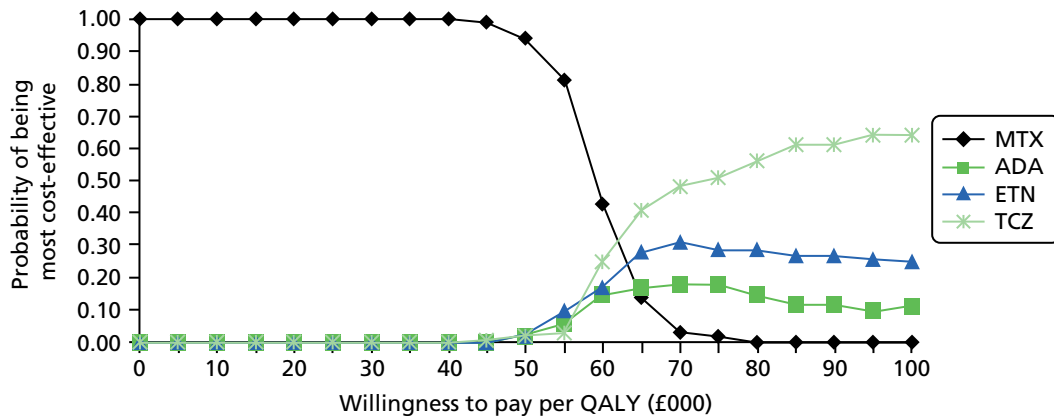
First intervention in the strategy	Discounted costs	Discounted QALYs	CPQ compared with MTX strategy (£)	Incremental CPQ (£)
SSZ	CiC information has been removed	CiC information has been removed	–	–
ADA	CiC information has been removed	CiC information has been removed	67,208	67,208
ETN	CiC information has been removed	CiC information has been removed	67,659	Extendedly dominated
TCZ	CiC information has been removed	CiC information has been removed	67,318	68,411

CPQ, cost per QALY gained.

**TABLE 295** Probabilistic base-case results mapping EULAR data from ACR data: ERAS cDMARD HAQ progression and a moderate, MTX-experienced, RA population treated with monotherapy

First intervention in the strategy	Discounted costs	Discounted QALYs	CPQ compared with MTX strategy (£)	Incremental CPQ (£)
SSZ	CiC information has been removed	CiC information has been removed	–	–
ETN	CiC information has been removed	CiC information has been removed	60,034	60,034
ADA	CiC information has been removed	CiC information has been removed	60,659	Extendedly dominated
TCZ	CiC information has been removed	CiC information has been removed	60,269	62,566

CPQ, cost per QALY gained.



**FIGURE 133** The CEAC when mapping EULAR data from ACR data: ERAS cDMARD HAQ progression and a moderate, MTX-experienced, RA population treated with monotherapy.

**American College of Rheumatology response measure: linear cDMARD Health Assessment Questionnaire progression and a moderate, methotrexate-experienced, rheumatoid arthritis population treated with monotherapy**

The base-case results for this population and those from sensitivity analyses are provided in *Tables 296–304*. The CEAC for the base case is shown in *Figure 134*.

It is seen that the ICERs of all the bDMARDs compared with the MTX strategy are in the region of £38,000–41,000.

It is seen that at a willingness to pay of £30,000 the SSZ strategy has the highest probability of being optimal.

**TABLE 296** Deterministic base-case results mapping EULAR data from ACR data: linear cDMARD HAQ progression and a moderate, MTX-experienced, RA population treated with monotherapy

First intervention in the strategy	Discounted costs	Discounted QALYs	CPQ compared with MTX strategy (£)	Incremental CPQ (£)
SSZ	CiC information has been removed	CiC information has been removed	–	–
ADA	CiC information has been removed	CiC information has been removed	38,751	Extendedly dominated
ETN	CiC information has been removed	CiC information has been removed	38,469	38,469
TCZ	CiC information has been removed	CiC information has been removed	40,644	94,949

CPQ, cost per QALY gained.

**TABLE 297** Deterministic results having included RCTs with a small proportion of previous bDMARD use (with adequate prior MTX exposure) mapping EULAR data from ACR data: linear cDMARD HAQ progression and a moderate, MTX-experienced, RA population treated with monotherapy

First intervention in the strategy	Discounted costs	Discounted QALYs	CPQ compared with MTX strategy (£)	Incremental CPQ (£)
SSZ	CiC information has been removed	CiC information has been removed	–	–
ADA	CiC information has been removed	CiC information has been removed	38,956	Extendedly dominated
ETN	CiC information has been removed	CiC information has been removed	38,547	38,547
TCZ	CiC information has been removed	CiC information has been removed	41,321	107,580

CPQ, cost per QALY gained.

**TABLE 298** Deterministic results having included RCTs with a small proportion of previous bDMARD use (irrespective of prior MTX exposure) mapping EULAR data from ACR data: linear cDMARD HAQ progression and a moderate, MTX-experienced, RA population treated with monotherapy

First intervention in the strategy	Discounted costs	Discounted QALYs	CPQ compared with MTX strategy (£)	Incremental CPQ (£)
SSZ	CiC information has been removed	CiC information has been removed	–	–
ADA	CiC information has been removed	CiC information has been removed	38,264	38,264
ETN	CiC information has been removed	CiC information has been removed	38,545	Extendedly dominated
TCZ	CiC information has been removed	CiC information has been removed	40,304	76,254

CPQ, cost per QALY gained.

**TABLE 299** Deterministic results having included RCTs with potentially low prior MTX exposure using ACR data mapped to EULAR data: ERAS cDMARD HAQ progression and a moderate, MTX-experienced, RA population treated with monotherapy

First intervention in the strategy	Discounted costs	Discounted QALYs	CPQ compared with MTX strategy (£)	Incremental CPQ (£)
SSZ	CiC information has been removed	CiC information has been removed	–	–
ADA	CiC information has been removed	CiC information has been removed	37,025	37,025
ETN	CiC information has been removed	CiC information has been removed	37,217	50,652
TCZ	CiC information has been removed	CiC information has been removed	40,508	85,586

CPQ, cost per QALY gained.

**TABLE 300** Deterministic results having used the mapping of HAQ to utility from Malottki *et al.*<sup>171</sup> rather than Hernandez-Alava *et al.*<sup>276</sup> mapping EULAR data from ACR data: linear cDMARD HAQ progression and a moderate, MTX-experienced, RA population treated with monotherapy

First intervention in the strategy	Discounted costs	Discounted QALYs	CPQ compared with MTX strategy (£)	Incremental CPQ (£)
SSZ	CiC information has been removed	CiC information has been removed	–	–
ADA	CiC information has been removed	CiC information has been removed	30,914	30,914
ETN	CiC information has been removed	CiC information has been removed	31,053	49,620
TCZ	CiC information has been removed	CiC information has been removed	32,431	56,717

CPQ, cost per QALY gained.

**TABLE 301** Deterministic results having used discount rates of 6% per annum for costs and 1.5% per annum for QALYs and mapping EULAR data from ACR data: linear cDMARD HAQ progression and a moderate, MTX-experienced, RA population treated with monotherapy

First intervention in the strategy	Discounted costs	Discounted QALYs	CPQ compared with MTX strategy (£)	Incremental CPQ (£)
SSZ	CiC information has been removed	CiC information has been removed	–	–
ADA	CiC information has been removed	CiC information has been removed	23,654	Extendedly dominated
ETN	CiC information has been removed	CiC information has been removed	23,766	23,766
TCZ	CiC information has been removed	CiC information has been removed	24,878	47,829

CPQ, cost per QALY gained.

**TABLE 302** Deterministic results assuming 100-fold increased impact of AEs and mapping EULAR data from ACR data: linear cDMARD HAQ progression and a moderate, MTX-experienced, RA population treated with monotherapy

First intervention in the strategy	Discounted costs	Discounted QALYs	CPQ compared with MTX strategy (£)	Incremental CPQ (£)
SSZ	CiC information has been removed	CiC information has been removed	–	–
ADA	CiC information has been removed	CiC information has been removed	39,857	39,857
ETN	CiC information has been removed	CiC information has been removed	40,477	Dominated
TCZ	CiC information has been removed	CiC information has been removed	42,660	147,373

CPQ, cost per QALY gained.



**TABLE 303** Deterministic results having used the relationship between HAQ and pain derived from ERAS: linear cDMARD HAQ progression and a moderate, MTX-experienced, RA population treated with monotherapy

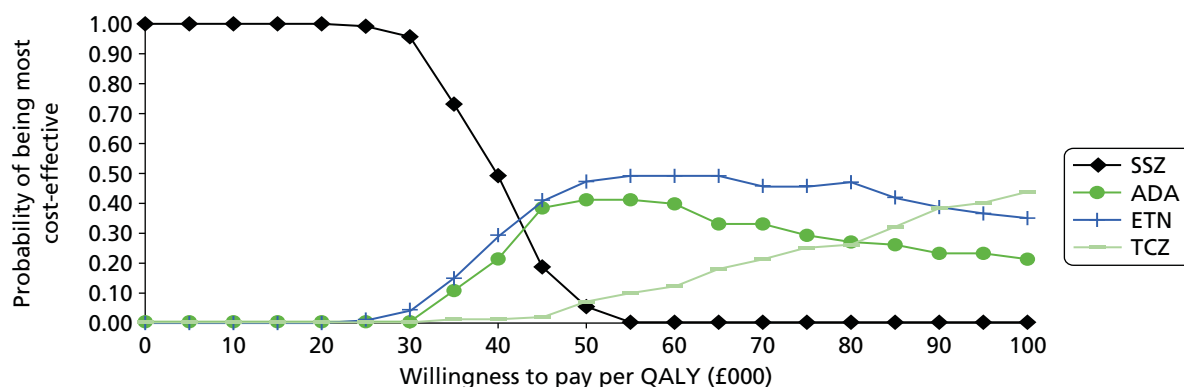
First intervention in the strategy	Discounted costs	Discounted QALYs	CPQ compared with MTX strategy (£)	Incremental CPQ (£)
SSZ	CiC information has been removed	CiC information has been removed	–	–
ADA	CiC information has been removed	CiC information has been removed	46,973	46,973
ETN	CiC information has been removed	CiC information has been removed	47,107	Dominated
TCZ	CiC information has been removed	CiC information has been removed	49,606	95,878

CPQ, cost per QALY gained.

**TABLE 304** Probabilistic base-case results mapping EULAR data from ACR data: linear cDMARD HAQ progression and a moderate, MTX-experienced, RA population treated with monotherapy

First intervention in the strategy	Discounted costs	Discounted QALYs	CPQ compared with MTX strategy (£)	Incremental CPQ (£)
SSZ	CiC information has been removed	CiC information has been removed	–	–
ADA	CiC information has been removed	CiC information has been removed	39,460	39,460
ETN	CiC information has been removed	CiC information has been removed	39,550	59,914
TCZ	CiC information has been removed	CiC information has been removed	41,843	84,981

CPQ, cost per QALY gained.

**FIGURE 134** The CEAC when mapping EULAR data from ACR data: linear cDMARD HAQ progression and a moderate, MTX-experienced, RA population treated with monotherapy

**Response measure American College of Rheumatology: Early Rheumatoid Arthritis Study cDMARD Health Assessment Questionnaire progression and a severe, methotrexate-naive, rheumatoid arthritis population**

The base-case results for this population and those from sensitivity analyses are provided in *Tables 305–311*. The CEAC for the base case is shown in *Figure 135*.

**TABLE 305** Deterministic base-case results mapping EULAR data from ACR data: ERAS cDMARD HAQ progression and a severe, MTX-naive, RA population

Strategy	Discounted costs	Discounted QALYs	Incremental CPQ (£)
MTX/intensive cDMARDs/NBT	CiC information has been removed	CiC information has been removed	–
bDMARDs/MTX/intensive cDMARDs/NBT	CiC information has been removed	CiC information has been removed	68,277

CPQ, cost per QALY gained.

**TABLE 306** Deterministic base-case results mapping EULAR data from ACR data: ERAS cDMARD HAQ progression including RCTs with some patients with prior cDMARD experience and a severe, MTX-naive, RA population

Strategy	Discounted costs	Discounted QALYs	Incremental CPQ (£)
MTX/intensive cDMARDs/NBT	CiC information has been removed	CiC information has been removed	–
bDMARDs/MTX/intensive cDMARDs/NBT	CiC information has been removed	CiC information has been removed	68,152

CPQ, cost per QALY gained.

**TABLE 307** Deterministic results having used the mapping of HAQ to utility from Malottki *et al.*<sup>171</sup> rather than Hernandez-Alava *et al.*<sup>276</sup> mapping EULAR data from ACR data: ERAS cDMARD HAQ progression and a severe, MTX-naive, RA population treated

Strategy	Discounted costs	Discounted QALYs	Incremental CPQ (£)
MTX/intensive cDMARDs/NBT	CiC information has been removed	CiC information has been removed	–
bDMARDs/MTX/intensive cDMARDs/NBT	CiC information has been removed	CiC information has been removed	50,504

CPQ, cost per QALY gained.

**TABLE 308** Deterministic results having used discount rates of 6% per annum for costs and 1.5% per annum for QALYs and mapping EULAR data from ACR data: ERAS cDMARD HAQ progression and a severe, MTX-naive, RA population treated

Strategy	Discounted costs	Discounted QALYs	Incremental CPQ (£)
MTX/intensive cDMARDs/NBT	CiC information has been removed	CiC information has been removed	–
bDMARDs/MTX/intensive cDMARDs/NBT	CiC information has been removed	CiC information has been removed	42,587

CPQ, cost per QALY gained.

**TABLE 309** Deterministic results assuming 100-fold increased impact of AEs and mapping EULAR data from ACR data: ERAS cDMARD HAQ progression and a severe, MTX-naive, RA

Strategy	Discounted costs	Discounted QALYs	Incremental CPQ (£)
MTX/intensive cDMARDs/NBT	CiC information has been removed	CiC information has been removed	–
bDMARDs/MTX/intensive cDMARDs/NBT	CiC information has been removed	CiC information has been removed	71,147

CPQ, cost per QALY gained.

**TABLE 310** Deterministic results having used the relationship between HAQ and pain derived from ERAS: ERAS cDMARD HAQ progression and a severe, MTX-naive, RA population

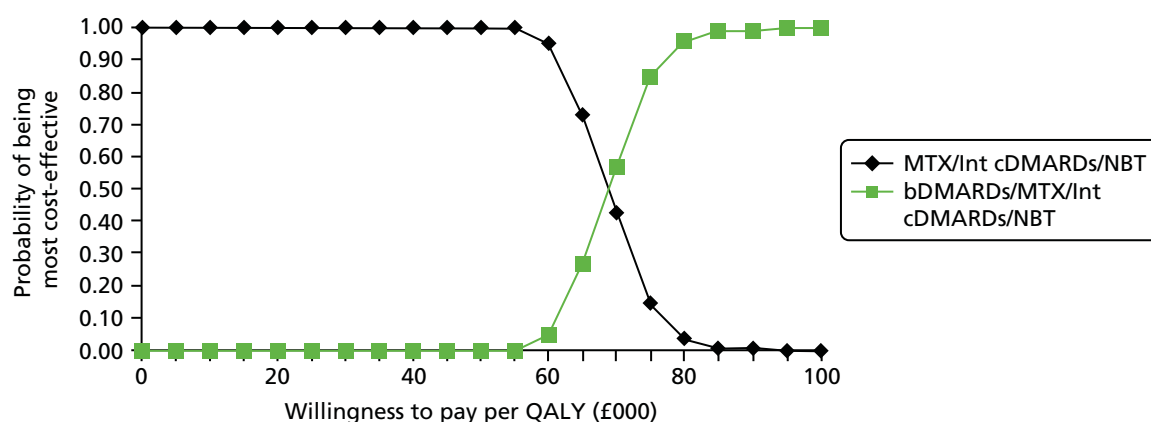
Strategy	Discounted costs	Discounted QALYs	Incremental CPQ (£)
MTX/intensive cDMARDs/NBT	CiC information has been removed	CiC information has been removed	–
bDMARDs/MTX/intensive cDMARDs/NBT	CiC information has been removed	CiC information has been removed	79,535

CPQ, cost per QALY gained.

**TABLE 311** Probabilistic base-case results mapping EULAR data from ACR data: ERAS cDMARD HAQ progression and a severe, MTX-naive, RA population

Strategy	Discounted costs	Discounted QALYs	Incremental CPQ (£)
MTX/intensive cDMARDs/NBT	CiC information has been removed	CiC information has been removed	–
bDMARDs/MTX/intensive cDMARDs/NBT	CiC information has been removed	CiC information has been removed	66,091

CPQ, cost per QALY gained.

**FIGURE 135** The CEAC when mapping EULAR data from ACR data: ERAS cDMARD HAQ progression and a severe, MTX-naive, RA population treated. Int, intensive.

It is seen that at a willingness to pay of £30,000 that MTX/intensive cDMARDs/NBT strategy has a very high probability of being optimal.

**Response measure American College of Rheumatology: linear cDMARD Health Assessment Questionnaire progression and a severe, methotrexate-naive, rheumatoid arthritis population**

The base-case results for this population and those from sensitivity analyses are provided in *Tables 312–318*. The CEAC for the base case is shown in *Figure 136*.

It is seen that at a willingness to pay of £30,000 the MTX/NBT strategy has a very high probability of being optimal.

**TABLE 312** Deterministic base-case results mapping EULAR data from ACR data: linear cDMARD HAQ progression and a severe, MTX-naive, RA population

Strategy	Discounted costs	Discounted QALYs	Incremental CPQ (£)
MTX/intensive cDMARDs/NBT	CiC information has been removed	CiC information has been removed	–
bDMARDs/MTX/intensive cDMARDs/NBT	CiC information has been removed	CiC information has been removed	58,290

CPQ, cost per QALY gained.

**TABLE 313** Deterministic base-case results mapping EULAR data from ACR data: ERAS cDMARD HAQ progression including RCTs with some patients with prior cDMARD experience and a severe, MTX-naive, RA population treated with monotherapy

Strategy	Discounted costs	Discounted QALYs	Incremental CPQ (£)
MTX/intensive cDMARDs/NBT	CiC information has been removed	CiC information has been removed	–
bDMARDs/MTX/intensive cDMARDs/NBT	CiC information has been removed	CiC information has been removed	58,065

CPQ, cost per QALY gained.

**TABLE 314** Deterministic results having used the mapping of HAQ to utility from Malotki *et al.*<sup>171</sup> rather than Hernandez-Alava *et al.*<sup>276</sup> mapping EULAR data from ACR data: linear cDMARD HAQ progression and a severe, MTX-naive, RA population

Strategy	Discounted costs	Discounted QALYs	Incremental CPQ (£)
MTX/intensive cDMARDs/NBT	CiC information has been removed	CiC information has been removed	–
bDMARDs/MTX/intensive cDMARDs/NBT	CiC information has been removed	CiC information has been removed	44,694

CPQ, cost per QALY gained.

**TABLE 315** Deterministic results having used discount rates of 6% per annum for costs and 1.5% per annum for QALYs and mapping EULAR data from ACR data: linear cDMARD HAQ progression and a severe, MTX-naive, RA population

Strategy	Discounted costs	Discounted QALYs	Incremental CPQ (£)
MTX/intensive cDMARDs/NBT	CiC information has been removed	CiC information has been removed	–
bDMARDs/MTX/intensive cDMARDs/NBT	CiC information has been removed	CiC information has been removed	33,580
CPQ, cost per QALY gained.			

**TABLE 316** Deterministic results assuming 100-fold increased impact of AEs and mapping EULAR data from ACR data: linear cDMARD HAQ progression and a severe, MTX-naive, RA population

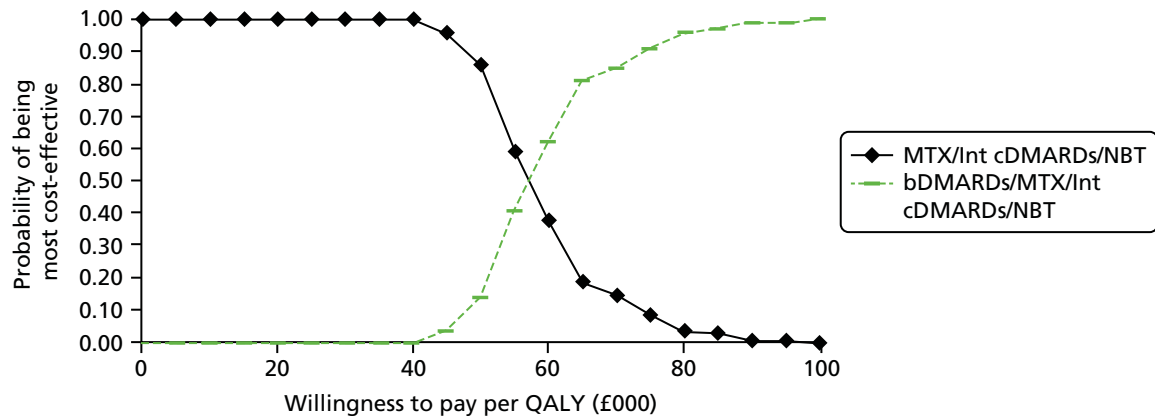
Strategy	Discounted costs	Discounted QALYs	Incremental CPQ (£)
MTX/intensive cDMARDs/NBT	CiC information has been removed	CiC information has been removed	–
bDMARDs/MTX/intensive cDMARDs/NBT	CiC information has been removed	CiC information has been removed	59,839
CPQ, cost per QALY gained.			

**TABLE 317** Deterministic results having used the relationship between HAQ and pain derived from ERAS: linear cDMARD HAQ progression and a severe, MTX-naive, RA population

Strategy	Discounted costs	Discounted QALYs	Incremental CPQ (£)
MTX/intensive cDMARDs/NBT	CiC information has been removed	CiC information has been removed	–
bDMARDs/MTX/intensive cDMARDs/NBT	CiC information has been removed	CiC information has been removed	68,258
CPQ, cost per QALY gained.			

**TABLE 318** Probabilistic base-case results mapping EULAR data from ACR data: linear cDMARD HAQ progression and a severe, MTX-naive, RA population

Strategy	Discounted costs	Discounted QALYs	Incremental CPQ (£)
MTX/intensive cDMARDs/NBT	CiC information has been removed	CiC information has been removed	–
bDMARDs/MTX/intensive cDMARDs/NBT	CiC information has been removed	CiC information has been removed	60,484
CPQ, cost per QALY gained.			



**FIGURE 136** The CEAC when mapping EULAR data from ACR data: linear cDMARD HAQ progression and a severe, MTX-naive, RA population. Int, intensive.

**Response measure American College of Rheumatology: Early Rheumatoid Arthritis Study cDMARD Health Assessment Questionnaire progression and a severe, MTX-naive, rheumatoid arthritis population treated with monotherapy**

The base-case results for this population and those from sensitivity analyses are provided in *Tables 319–325*. The CEAC for the base case is shown in *Figure 137*.

**TABLE 319** Deterministic base-case results mapping EULAR data from ACR data: ERAS cDMARD HAQ progression and a severe, MTX-naive, RA population treated with monotherapy

Strategy	Discounted costs	Discounted QALYs	Incremental CPQ (£)
SSZ/intensive cDMARDs/NBT	CiC information has been removed	CiC information has been removed	–
bDMARDs/SSZ/intensive cDMARDs/NBT	CiC information has been removed	CiC information has been removed	68,277

CPQ, cost per QALY gained.

**TABLE 320** Deterministic base-case results mapping EULAR data from ACR data: ERAS cDMARD HAQ progression and a severe, MTX-naive, RA population treated with monotherapy including RCTs with a small percentage of prior cDMARD experience

Strategy	Discounted costs	Discounted QALYs	Incremental CPQ (£)
SSZ/intensive cDMARDs/NBT	CiC information has been removed	CiC information has been removed	–
bDMARDs/SSZ/intensive cDMARDs/NBT	CiC information has been removed	CiC information has been removed	68,152

CPQ, cost per QALY gained.

**TABLE 321** Deterministic results having used the mapping of HAQ to utility from Malottki *et al.*<sup>171</sup> rather than Hernandez-Alava *et al.*<sup>276</sup> mapping EULAR data from ACR data: ERAS cDMARD HAQ progression and a severe, MTX-naive, RA population treated with monotherapy

Strategy	Discounted costs	Discounted QALYs	Incremental CPQ (£)
SSZ/intensive cDMARDs/NBT	CiC information has been removed	CiC information has been removed	–
bDMARDs/SSZ/intensive cDMARDs/NBT	CiC information has been removed	CiC information has been removed	50,504
CPQ, cost per QALY gained.			

**TABLE 322** Deterministic results having used discount rates of 6% per annum for costs and 1.5% per annum for QALYs and mapping EULAR data from ACR data: ERAS cDMARD HAQ progression and a severe, MTX-naive, RA population treated with monotherapy

Strategy	Discounted costs	Discounted QALYs	Incremental CPQ (£)
SSZ/intensive cDMARDs/NBT	CiC information has been removed	CiC information has been removed	–
bDMARDs/SSZ/intensive cDMARDs/NBT	CiC information has been removed	CiC information has been removed	42,587
CPQ, cost per QALY gained.			

**TABLE 323** Deterministic results assuming 100-fold increased impact of AEs and mapping EULAR data from ACR data: linear cDMARD HAQ progression and a severe, MTX-naive, RA population treated with monotherapy

Strategy	Discounted costs	Discounted QALYs	Incremental CPQ (£)
SSZ/intensive cDMARDs/NBT	CiC information has been removed	CiC information has been removed	–
bDMARDs/SSZ/intensive cDMARDs/NBT	CiC information has been removed	CiC information has been removed	71,147
CPQ, cost per QALY gained.			

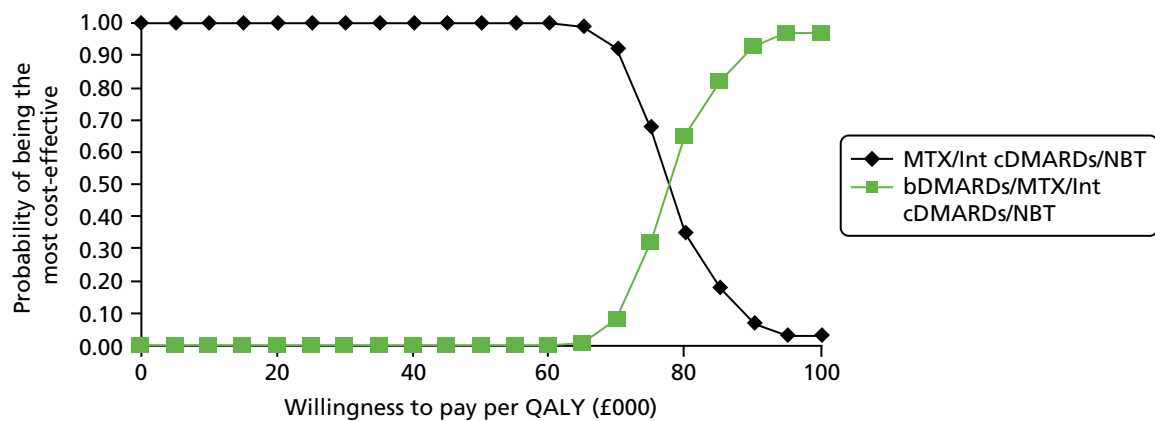
**TABLE 324** Deterministic results having used the relationship between HAQ and pain derived from ERAS: ERAS cDMARD HAQ progression and a severe, MTX-naive, RA population treated with monotherapy

Strategy	Discounted costs	Discounted QALYs	Incremental CPQ (£)
SSZ/intensive cDMARDs/NBT	CiC information has been removed	CiC information has been removed	–
bDMARDs/SSZ/intensive cDMARDs/NBT	CiC information has been removed	CiC information has been removed	79,535
CPQ, cost per QALY gained.			

**TABLE 325** Probabilistic base-case results mapping EULAR data from ACR data: ERAS cDMARD HAQ progression and a severe, MTX-naive, RA population treated with monotherapy

Strategy	Discounted costs	Discounted QALYs	Incremental CPQ (£)
SSZ/intensive cDMARDs/NBT	CiC information has been removed	CiC information has been removed	–
bDMARDs/SSZ/intensive cDMARDs/NBT	CiC information has been removed	CiC information has been removed	66,091

CPQ, cost per QALY gained.



**FIGURE 137** The CEAC when mapping EULAR data from ACR data: ERAS cDMARD HAQ progression and a severe, MTX-naive, RA population treated with monotherapy. Int, intensive.

**Response measure American College of Rheumatology: linear cDMARD Health Assessment Questionnaire progression and a severe, methotrexate-naive, rheumatoid arthritis population treated with monotherapy**

The base-case results for this population and those from sensitivity analyses are provided in *Tables 326–332*. The CEAC for the base case is shown in *Figure 138*.

**TABLE 326** Deterministic base-case results mapping EULAR data from ACR data: linear cDMARD HAQ progression and a severe, MTX-naive, RA population treated with monotherapy

Strategy	Discounted costs	Discounted QALYs	Incremental CPQ (£)
SSZ/intensive cDMARDs/NBT	CiC information has been removed	CiC information has been removed	–
bDMARDs/SSZ/intensive cDMARDs/NBT	CiC information has been removed	CiC information has been removed	58,290

CPQ, cost per QALY gained.



**TABLE 327** Deterministic base-case results mapping EULAR data from ACR data: linear cDMARD HAQ progression and a severe, MTX-naive, RA population treated with monotherapy including RCTs with a small percentage of prior cDMARD experience

Strategy	Discounted costs	Discounted QALYs	Incremental CPQ (£)
SSZ/intensive cDMARDs/NBT	CiC information has been removed	CiC information has been removed	–
bDMARDs/SSZ/intensive cDMARDs/NBT	CiC information has been removed	CiC information has been removed	58,065
CPQ, cost per QALY gained.			

**TABLE 328** Deterministic results having used the mapping of HAQ to utility from Malottki *et al.*<sup>171</sup> rather than Hernandez-Alava *et al.*<sup>276</sup> mapping EULAR data from ACR data: linear cDMARD HAQ progression and a severe, MTX-naive, RA population treated with monotherapy

Strategy	Discounted costs	Discounted QALYs	Incremental CPQ (£)
SSZ/intensive cDMARDs/NBT	CiC information has been removed	CiC information has been removed	–
bDMARDs/SSZ/intensive cDMARDs/NBT	CiC information has been removed	CiC information has been removed	44,694
CPQ, cost per QALY gained.			

**TABLE 329** Deterministic results having used discount rates of 6% per annum for costs and 1.5% per annum for QALYs and mapping EULAR data from ACR data: linear cDMARD HAQ progression and a severe, MTX-naive, RA population treated with monotherapy

Strategy	Discounted costs	Discounted QALYs	Incremental CPQ (£)
SSZ/intensive cDMARDs/NBT	CiC information has been removed	CiC information has been removed	–
bDMARDs/SSZ/intensive cDMARDs/NBT	CiC information has been removed	CiC information has been removed	33,580
CPQ, cost per QALY gained.			

**TABLE 330** Deterministic results assuming 100-fold increased impact of AEs and mapping EULAR data from ACR data: linear cDMARD HAQ progression and a severe, MTX-naive, RA population treated with monotherapy

Strategy	Discounted costs	Discounted QALYs	Incremental CPQ (£)
SSZ/intensive cDMARDs/NBT	CiC information has been removed	CiC information has been removed	–
bDMARDs/SSZ/intensive cDMARDs/NBT	CiC information has been removed	CiC information has been removed	59,839
CPQ, cost per QALY gained.			

**TABLE 331** Deterministic results having used the relationship between HAQ and pain derived from ERAS: linear cDMARD HAQ progression and a severe, MTX-naive, RA population treated with monotherapy

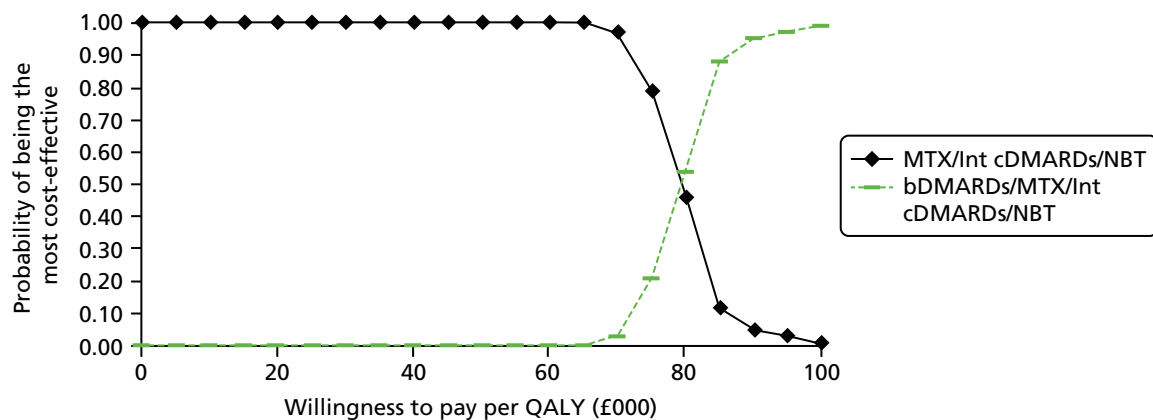
Strategy	Discounted costs	Discounted QALYs	Incremental CPQ (£)
SSZ/intensive cDMARDs/NBT	CiC information has been removed	CiC information has been removed	–
bDMARDs/SSZ/intensive cDMARDs/NBT	CiC information has been removed	CiC information has been removed	68,258

CPQ, cost per QALY gained.

**TABLE 332** Probabilistic base-case results mapping EULAR data from ACR data: linear cDMARD HAQ progression and a severe, MTX-naive, RA population treated with monotherapy

Strategy	Discounted costs	Discounted QALYs	Incremental CPQ (£)
SSZ/intensive cDMARDs/NBT	CiC information has been removed	CiC information has been removed	–
bDMARDs/SSZ/intensive cDMARDs/NBT	CiC information has been removed	CiC information has been removed	60,484

CPQ, cost per QALY gained.

**FIGURE 138** The CEAC when mapping EULAR data from ACR data: linear cDMARD HAQ progression and a severe, MTX-naive, RA population. Int, intensive.

## Interpretation of the results

### *Methotrexate-experienced rheumatoid arthritis patients*

It is seen that the results are particularly sensitive to the assumptions made regarding the progression of HAQ while on cDMARDs, particularly for those with moderate RA and for those who cannot receive MTX.

The base-case analyses undertaken by the Assessment Group estimate the HAQ progression while on cDMARDs to be that produced by a statistical analysis of the ERAS database, which contains a large number of patients diagnosed with RA with a 15-year follow-up. This results in ICERs for the bDMARDs typically > £40,000 per QALY when compared with a cDMARD-alone option for patients with severe disease who can receive MTX. This value rises to £50,000 per QALY when patients with moderate disease are evaluated.

In contrast, the manufacturers typically used a linear HAQ progression that has been used in previous NICE appraisals,<sup>26,28,171,207</sup> when the Assessment Group used the same assumptions the ICERs were typically in the region of £30,000–40,000 per QALY for both patients with severe or moderate disease.

The most appropriate HAQ progression to assume is discussed in *Health Assessment Questionnaire trajectory following initial response*. The Assessment Group believes that the progression calculated from ERAS data is likely to be more plausible, although may underestimate HAQ progression as it may contain patients who would not receive bDMARDs.

Altering the discount rate to that used in the initial appraisals of bDMARDs (6% per annum for costs and 1.5% per annum for QALYs) noticeably reduces the ICERs; using the relationship between HAQ and pain from a different data source noticeably increases the ICERs. The ICERs for severe RA patients were typically lower than for moderate RA patients, although the difference was smaller when a linear HAQ progression was used.

The results between EULAR-only data and EULAR mapped from ACR were comparable, which is reassuring given the wider evidence base reporting ACR data.

The ICERs for those patients who receive monotherapy are higher than for those who can be treated with MTX, increasing to approximately £48,000 per QALY gained for patients with severe RA, approximately £59,000 using the ERAS HAQ progression, and increasing to approximately £39,000 for both groups when using the linear HAQ progression.

### **Methotrexate-naive rheumatoid arthritis patients**

The ICERs associated with treating with bDMARDs prior to MTX are over £60,000 per QALY gained for patients regardless of whether or not the patient can receive MTX or whether the assumed HAQ progression was linear or that estimated from the ERAS data set.

In addition, these ICERs are expected to be highly favourable to bDMARDs, as it is assumed that the HAQ progressions associated with single cDMARDs (either linear or non-linear) would also apply to intensive cDMARDs, which, according to the clinical advisors to the Assessment Group, is becoming widespread. If, as expected, the HAQ progression on intensive cDMARDs was lower than that assumed within the analyses then the ICERs would increase, potentially very considerably.

## **Discussion**

### **Summary of key results**

See *Chapter 6, Statement of principal findings*.

### **Comparison of the Assessment Group results and those produced by the companies**

The base-case ICERs estimated by the Assessment Group are considerably higher than those estimated by the companies, whose values for patients who have severe RA and can receive MTX typically lie between £20,000 and £30,000 per QALY gained. Contrastingly, the base-case value produced by the Assessment Group was £37,000.

The discrepancy is initially reduced if the value produced by the Assessment Group when using the linear model and the Malottki *et al.*<sup>171</sup> HAQ to utility mapping is used. This evaluation is more in line with the analyses conducted by the companies and in this scenario the median ICER in the Assessment Group model fell to £32,400.

On investigation, it was seen that the reduction in HAQ assumed with a positive response to treatment was typically assumed to be greater in the submissions from the companies (see *Health Assessment Questionnaire/European Quality of Life-5 Dimensions changes in relation to response levels*) than that seen in the BSRBR database and used by the Assessment Group. To illustrate this, if the HAQ reduction values assumed by AbbVie were applied, a patient with an initial HAQ of 2.0 would, following an ACR50–70 response, be assumed to have a HAQ of 0.77 (a reduction of 1.23); contrastingly, the BSRBR data show that on average the HAQ reduction following a good response is 0.67, resulting in a HAQ of 1.33. The use of greater HAQ reductions for bDMARDs will have the effect of reducing the ICER, as HAQ is linked to utility and to disease-related cost. It is noted that the HAQ changes assumed by the companies are typically taken from relatively small RCTs whereas the Assessment Group has used a large UK database.

Additionally, not all submissions have assumed that HAQ score will affect mortality. The approach taken within the Assessment Group model is that people with greater HAQ score on model entry will die, on average, earlier than those with lower HAQ scores. If such an assumption was not applied, this would be expected to have the impact of reducing the ICER, owing to the greater number of years the most severe patients lived, with both low utility and high disease-related costs and the likely difference in HAQ progression between those on cDMARDs and those on bDMARDs.

These reasons lead the Assessment Group to believe that there is no large unexplainable difference between its model and those submitted by the companies. Although other differences exist, for example the Assessment Group model is EULAR based, whereas the majority of company models are ACR based, it is not clear that such differences would represent a systematic difference in the comparative ICERs.

### **Generalisability of results**

There is no reason to believe that the results detailed in this report are not generalisable to the English and Welsh populations.

### **Strengths and limitations of analysis**

A strength of this report is that a systematic review of RCTs for bDMARDs in bDMARD-naïve patients has been conducted. The primary outcome measures are EULAR or ACR response at 6 months and a formal NMA has been conducted to assess relative effectiveness. Different analyses have been undertaken to assess the impact of including RCTs with a small proportion of patients with prior bDMARD use, and/or including RCTs when patients may not have received adequate prior MTX treatment.

A major strength of the analyses presented is that the Assessment Group has constructed a EULAR-based model that is much more appropriate to practice in England and Wales than previous ACR-based models. Estimates of ICERs for both EULAR data only and when mapping ACR data to EULAR data indicate that the conclusions were not altered by restricting the selection of RCTs to only those that reported EULAR data.

An additional strength is that large observational databases were used to generate data on parameters such as HAQ change conditional on EULAR response and HAQ progression while on cDMARDs. This is preferable to data taken from relatively small RCTs of limited follow-up.

The model has known limitations. The plausible reduced efficacy of treatments when used subsequent to other treatments has not been formally incorporated. It is expected that this omission will favour bDMARDs. Additionally, the effects of non-adherence to NICE guidelines (as shown in the BSRBR) have not formally been incorporated; it is expected that, were this included, then the ICERs for bDMARDs compared with cDMARDs would increase and disfavour bDMARDs.

Lost productivity has not been included in the model, which could favour bDMARDs if it were included. However, an estimation of any lost productivity gains associated with technologies not funded because of the purchase of bDMARDs would be required to produce a definitive conclusion on the effect on the ICER.

## Chapter 5 Assessment of factors relevant to the NHS and other parties

Beyond potential impact on expenditure there is unlikely to be any major implications for the NHS as the interventions are largely s.c. and self-administered. The implications for expenditure are uncertain as it will be heavily dependent on the guidance produced by NICE.



# Chapter 6 Discussion

## Statement of principal findings

Although there was uncertainty in, and overlap between, the effects of treatment on ACR for interventions for patients in population 1, IFX plus MTX was associated with the biggest increase in response rate and this was likely to be the most effective intervention. Other interventions were less effective and appeared to fall into three groups: intensive cDMARDs and ADA plus MTX; ETN, GOL plus MTX and step-up combination cDMARDs; ADA and cDMARDs.

Although there was uncertainty in, and overlap between, the effects of treatment on EULAR for interventions in populations 2 and 3 in the main trials, ETN plus MTX and TCZ plus MTX were associated with the biggest increase in response rate. Other interventions were less effective and appeared to fall into two groups: (1) TCZ, GOL plus MTX, ADA plus MTX, ABT i.v. plus MTX and grouped biologics; and (2) ETN, IFX plus MTX, ADA and intensive cDMARDs. The inclusion of the additional studies in which patients received prior biologics resulted in broadly the same groupings, although CTZ plus MTX was associated with an even bigger response than ETN plus MTX and TCZ plus MTX.

Although there was uncertainty in, and overlap between, the effects of treatment on ACR for interventions in populations 2 and 3 in the main trials, ETN plus MTX, TCZ and TCZ plus MTX were associated with the biggest increase in response rate. Other interventions were less effective and appeared to fall into two groups: (1) ETN, GOL plus MTX, ABT s.c. plus MTX, ADA plus MTX, IFX plus MTX and ABT i.v. plus MTX; and (2) CTZ plus MTX, intensive cDMARDs and ADA. The inclusion of the additional studies in which patients received prior biologics suggested that CTZ plus MTX and ETN plus MTX resulted in the highest response rates. Other interventions appeared to give rise to broadly similar and slightly smaller response rates except for intensive cDMARDs and ADA which are associated with even smaller response rates.

The Assessment Group believes the ICERs for bDMARDs used in MTX-experienced patients with severe RA is credibly > £40,000 per QALY gained when compared with a cDMARD-alone strategy. These values are higher (£50,000) for moderate RA patients, higher for patients who cannot receive MTX and higher when bDMARDs were used before cDMARDs (£60,000), although this last estimate is likely to be favourable to bDMARDs owing to the assumption of HAQ progression while on intensive cDMARDs.

These estimates are lower if a different assumption, used in previous NICE appraisals regarding HAQ progression on cDMARDs, is adopted; however, the Assessment Group found few data to support this historic assumption.

The analyses have assumed that the discontinuation rule specified by NICE has been strictly adhered to: data from the BSRBR show that this is not the case. If such non-adherence continues the ICERs will be considerably higher than those presented. Analysis of the impact has not been undertaken owing to the possibility of back-calculation of CiC discounts offered through PASs.

## Strengths and limitations of the assessment

A strength of this report is that a systematic review of RCTs for bDMARDs in bDMARD-naive patients has been conducted. The primary outcome measures are EULAR or ACR response at 6 months and a formal NMA has been conducted to assess relative efficacy. Different analyses have been undertaken to assess the impact of including RCTs with a small proportion on patients with prior bDMARD use, and/or including RCTs when patients may not have received adequate prior MTX treatment.

A major strength of the analyses presented is that the Assessment Group has constructed a EULAR-based model that is much more appropriate to practice in England and Wales than previous ACR-based models. Estimates of ICERs both for EULAR data only and when mapping ACR data to EULAR data indicate that the conclusions were not altered by restricting the selection of RCTs to those that reported EULAR data.

An additional strength is that large observational databases were used to generate data on parameters such as HAQ change conditional on EULAR response and HAQ progression while on cDMARDs. This is preferable to data taken from relatively small RCTs with limited follow-up.

The model has known limitations. The plausible reduced efficacy of treatments when used subsequent to other treatments has not been formally incorporated. It is expected that this omission will favour bDMARDs. Additionally, the effects of non-adherence to NICE guidelines (as shown in the BSRBR) have not formally been incorporated; it is expected that were this included then the ICERs for bDMARDs compared with cDMARDs would increase and disfavour bDMARDs.

Lost productivity has not been included in the model, although the impact of lost productivity in those interventions displaced due to purchasing bDMARDs is unknown.

### Uncertainties

A key uncertainty relating to the cost-effectiveness results is related to the HAQ progression while on cDMARDs. This has been shown to have a large influence on the results, particularly for patients with moderate RA and those who cannot receive MTX. The relationship between HAQ and pain can also greatly influence the ICER, as is currently uncertain, with two large observational databases providing different estimated relationships.



# Chapter 7 Conclusions

## Implications for service provision

The implications for service provision are unclear and would be dependent on the final guidance issued by NICE. The majority of interventions are administered subcutaneously by the patient or family member, although it is possible that requirements for infusions or for district nurse time are affected conditional on the final guidance.

## Suggested research priorities

In order to provide a more accurate estimate of the cost-effectiveness of bDMARDs the following research priorities are suggested by the Assessment Group. These aim to establish:

- the evaluation of the long-term HAQ trajectory while on cDMARDs
- the relationship between HAQ and utility
- the relationship between HAQ and hospital costs consumed
- the relationship between HAQ and pain
- the relative efficacy of bDMARDs assessed through head-to-head RCTs, although it is acknowledged that this is unlikely to occur owing to the large-scale, costly RCTs that would be required
- the relative efficacy of bDMARDs when used after a previous bDMARD and/or RTX compared with bDMARD naïve
- the relative efficacy of cDMARDs when used after a bDMARD and/or RTX compared with bDMARD naïve
- whether or not bDMARDs could be stopped once a patient has achieved a stated target (e.g. remission).



# Acknowledgements

The authors wish to thank the BSRBR for providing access to their data and expert advice on how to use it, in particular Rebecca Davies, Xuejuan Fan, Kath Watson and Kimme Hyrich; Sam Norton for providing data and expert analyses from the ERAS data set; the VARA database for providing access to their data, and Kaleb Michaid for performing analyses on those data. The authors wish to thank Alan Brennan, Louise Preston and Colin Angus for advice and help throughout the project.

The authors would also like to thank Gill Rooney and Andrea Shippam for providing administrative support, help in preparing and formatting the report. Gill Rooney also assisted with digitising curves from published papers.

## Contributions of authors

**Matt Stevenson** led the project and was involved in all aspects of the project.

**Rachel Archer** led the systematic review along with **Emma Simpson** and **Emma Everson-Hock**.

**Jon Tosh** constructed the mathematical model and undertook the review of economic evaluations.

**John Stevens** undertook the NMA.

**Monica Hernandez-Alava**, along with **Allan Wailoo**, formulated statistical models based on these data.

**Suzy Paisley** and **Kath Dickinson** formulated and ran the search strategies.

**David Scott** and **Adam Young** provided clinical advice.

**Allan Wailoo** provided advice throughout the project, liaised with registry holders, commented on elements of the manufacturer submissions and provided a detailed account of the utility mapping models.

## About the School of Health and Related Research

The SCHARR is one of the nine departments that constitute the Faculty of Medicine, Dentistry and Health at the University of Sheffield. SCHARR specialises in health services and public health research, and the application of health economics and decision science to the development of health services and the improvement of public health.

The SCHARR Technology Assessment Group synthesises research on the clinical effectiveness and cost-effectiveness of health-care interventions for the National Institute for Health Research HTA programme on behalf of a range of policy-makers, including NICE. SCHARR Technology Assessment Group is part of a wider collaboration of a number of units from other regions including Health Economics Research Unit and Health Services Research Unit, University of Aberdeen; Southampton HTA Centre, University of Southampton; Liverpool Reviews and Implementation Group, University of Liverpool; Peninsular Technology Assessment Group, University of Exeter; the NHS Centre for Reviews and Dissemination, University of York; Warwick Evidence, University of Warwick; the BMJ Technology Assessment Group, BMJ Evidence Centre; and Kleijnen Systematic Reviews Ltd.

## Data sharing statement

Data can be obtained from the corresponding author subject to them being non-confidential.



## References

1. Scott DL, Steer S. The course of established rheumatoid arthritis. *Best Pract Res Clin Rheumatol* 2007;**21**:943–67. <http://dx.doi.org/10.1016/j.berh.2007.05.006>
2. Pincus T, Fuchs HA, Callahan LF, Nance EP Jr, Kaye JJ. Early radiographic joint space narrowing and erosion and later malalignment in rheumatoid arthritis: a longitudinal analysis. *J Rheumatol* 1998;**25**:636–40.
3. Drossaers-Bakker KW, Kroon HM, Zwinderman AH, Breedveld FC, Hazes JM. Radiographic damage of large joints in long-term rheumatoid arthritis and its relation to function. *Rheumatology* 2000;**39**:998–1003. <http://dx.doi.org/10.1093/rheumatology/39.9.998>
4. Allaire S, Wolfe F, Niu J, LaValley MP, Zhang B, Reisine S. Current risk factors for work disability associated with rheumatoid arthritis: recent data from a US national cohort. *Arthritis Rheum* 2009;**61**:321–8. <http://dx.doi.org/10.1002/art.24281>
5. Naz SM, Symmons DP. Mortality in established rheumatoid arthritis. *Best Pract Res Clin Rheumatol* 2007;**21**:871–83. <http://dx.doi.org/10.1016/j.berh.2007.05.003>
6. Dadoun S, Zeboulon-Ktorza N, Combescure C, Elhai M, Rozenberg S, Gossec L, *et al*. Mortality in rheumatoid arthritis over the last fifty years: systematic review and meta-analysis. *Joint Bone Spine* 2013;**80**:29–33. <http://dx.doi.org/10.1016/j.jbspin.2012.02.005>
7. Meune C, Touze E, Trinquart L, Allanore Y. Trends in cardiovascular mortality in patients with rheumatoid arthritis over 50 years: a systematic review and meta-analysis of cohort studies. *Rheumatology* 2009;**48**:1309–13. <http://dx.doi.org/10.1093/rheumatology/kep252>
8. Arnett FC, Edworthy SM, Bloch DA, McShane DJ, Fries JF, Cooper NS, *et al*. The American Rheumatism Association 1987 revised criteria for the classification of rheumatoid arthritis. *Arthritis Rheum* 1988;**31**:315–24. <http://dx.doi.org/10.1002/art.1780310302>
9. National Collaborating Centre for Chronic Conditions (UK). *Rheumatoid Arthritis: National Clinical Guideline for Management and Treatment in Adults*. London: Royal College of Physicians; 2009.
10. Combe B, Landewe R, Lukas C, Bolosiu HD, Breedveld F, Dougados M, *et al*. EULAR recommendations for the management of early arthritis: report of a task force of the European Standing Committee for International Clinical Studies Including Therapeutics (ESCSIT). *Ann Rheum Dis* 2007;**66**:34–45. <http://dx.doi.org/10.1136/ard.2005.044354>
11. Aletaha D, Neogi T, Silman AJ, Funovits J, Felson DT, Bingham CO III, *et al*. 2010 rheumatoid arthritis classification criteria: an American College of Rheumatology/European League Against Rheumatism collaborative initiative. *Ann Rheum Dis* 2010;**69**:1580–8. <http://dx.doi.org/10.1136/ard.2010.138461>
12. Felson DT, Anderson JJ, Boers M, Bombardier C, Furst D, Goldsmith C, *et al*. American College of Rheumatology preliminary definition of improvement in rheumatoid arthritis. *Arthritis Rheum* 1995;**38**:727–35. <http://dx.doi.org/10.1002/art.1780380602>
13. van Gestel AM, Prevoo ML, van't Hof MA, van Rijswijk MH, van de Putte LB, van Riel PL. Development and validation of the European League Against Rheumatism response criteria for rheumatoid arthritis. Comparison with the preliminary American College of Rheumatology and the World Health Organization/International League Against Rheumatism Criteria. *Arthritis Rheum* 1996;**39**:34–40. <http://dx.doi.org/10.1002/art.1780390105>
14. Felson DT. Assessing the efficacy and safety of rheumatic disease treatments: obstacles and proposed solutions. *Arthritis Rheum* 2003;**48**:1781–7. <http://dx.doi.org/10.1002/art.11087>

15. Prevoo M, van't Hof M, Kuper H, Van Leeuwen M, van de Putte L, van Riel P. Modified disease activity scores that include twenty-eight-joint counts. Development and validation in a prospective longitudinal study of patients with rheumatoid arthritis. *Arthritis Rheum* 1995;**38**:44–8. <http://dx.doi.org/10.1002/art.1780380107>
16. van Gestel AM, Anderson JJ, van Riel PL, Boers M, Haagsma CJ, Rich B, *et al*. ACR and EULAR improvement criteria have comparable validity in rheumatoid arthritis trials. American College of Rheumatology European League of Associations for Rheumatology. *J Rheumatol* 1999;**26**:705–11.
17. Bruce B, Fries JF. The Health Assessment Questionnaire (HAQ). *Clin Exp Rheumatol* 2005;**23**:S14–18.
18. Symmons D, Turner G, Webb R, Asten P, Barrett EM, Lunt M, *et al*. The prevalence of rheumatoid arthritis in the United Kingdom: new estimates for a new century. *Rheumatology* 2002;**41**:793–800. <http://dx.doi.org/10.1093/rheumatology/41.7.793>
19. Symmons DP, Barrett EM, Bankhead CR, Scott DG, Silman AJ. The incidence of rheumatoid arthritis in the United Kingdom: results from the Norfolk Arthritis Register. *Br J Rheumatol* 1994;**33**:735–9. <http://dx.doi.org/10.1093/rheumatology/33.8.735>
20. Alamanos Y, Drosos AA. Epidemiology of adult rheumatoid arthritis. *Autoimmun Rev* 2005;**4**:130–6. <http://dx.doi.org/10.1016/j.autrev.2004.09.002>
21. Lugmani R, Hennell S, Estrach C, Birrell F, Bosworth A, Davenport G, *et al*. British Society for Rheumatology and British Health Professionals in Rheumatology Guideline for the management of rheumatoid arthritis (the first 2 years). *Rheumatology* 2006;**45**:1167–9. <http://dx.doi.org/10.1093/rheumatology/kel215a>
22. National Institute for Health and Care Excellence. *Adalimumab, Etanercept and Infliximab for the Treatment of Rheumatoid Arthritis*; 2007. URL: [www.nice.org.uk/guidance/TA130](http://www.nice.org.uk/guidance/TA130) (accessed 30 July 2013).
23. National Institute for Health and Care Excellence. *Certolizumab Pegol for the Treatment of Rheumatoid Arthritis*; 2010. URL: [www.nice.org.uk/guidance/TA186](http://www.nice.org.uk/guidance/TA186) (accessed 2 August 2013).
24. National Institute for Health and Care Excellence. *Golimumab for the Treatment of Rheumatoid Arthritis after the Failure of Previous Disease-Modifying Anti-Rheumatic Drugs*; 2011. URL: [www.nice.org.uk/guidance/TA225](http://www.nice.org.uk/guidance/TA225) (accessed 30 July 2013).
25. National Institute for Health and Care Excellence. *Rheumatoid Arthritis (Methotrexate-Naïve) – Golimumab (Terminated Appraisal): Guidance*; 2011. URL: [www.nice.org.uk/guidance/TA224](http://www.nice.org.uk/guidance/TA224) (accessed 30 July 2013).
26. National Institute for Health and Care Excellence. *Tocilizumab for the Treatment of Rheumatoid Arthritis (Rapid Review of Technology Appraisal Guidance 198)*. TA247; 2012. URL: [www.nice.org.uk/guidance/ta247](http://www.nice.org.uk/guidance/ta247) (accessed 31 July 2013).
27. National Institute for Health and Care Excellence. *Abatacept for Treating Rheumatoid Arthritis After the Failure of Conventional Disease-Modifying Anti-Rheumatic Drugs (Rapid Review of Technology Appraisal Guidance 234)*; 2013. URL: [www.nice.org.uk/guidance/TA280](http://www.nice.org.uk/guidance/TA280) (accessed 2 August 2013).
28. National Institute for Health and Care Excellence. *Adalimumab, Etanercept, Infliximab, Rituximab and Abatacept for the Treatment of Rheumatoid Arthritis After the Failure of a TNF Inhibitor*; 2010. URL: [www.nice.org.uk/guidance/ta195](http://www.nice.org.uk/guidance/ta195) (accessed 2 August 2013).

29. School of Health and Related Research, University of Sheffield. *NICE Protocol – Adalimumab, Etanercept, Infliximab, Certolizumab Pegol, Golimumab, Tocilizumab and Abatacept for the Treatment of Rheumatoid Arthritis not Previously Treated with Disease – Modifying Anti-Rheumatic Drugs and After the Failure of Conventional Disease-Modifying Anti-Rheumatic Drugs Only (Review of Technology Appraisal Guidance 130, 186, 224, 234 and a Part Review of Technology Appraisal Guidance 225 and 247)*. Sheffield: University of Sheffield; 2012.
30. Joint Formulary Committee. *British National Formulary*. 64 ed. London: BMJ Group and Pharmaceutical Press; 2012.
31. Haynes RB, McKibbin KA, Wilczynski NL, Walter SD, Were SR, Hedges Team. Optimal search strategies for retrieving scientifically strong studies of treatment from MEDLINE: analytical survey. *BMJ* 2005;**330**:1179. <http://dx.doi.org/10.1136/bmj.38446.498542.8F>
32. Montori VM, Wilczynski NL, Morgan D, Haynes RB. Optimal search strategies for retrieving systematic reviews from MEDLINE: analytical survey. *BMJ* 2005;**330**:68 <http://dx.doi.org/10.1136/bmj.38336.804167.47>
33. Wong SS, Wilczynski NL, Haynes RB. Optimal CINAHL search strategies for identifying therapy studies and review articles. *J Nurs Scholarsh* 2006;**38**:194–9. <http://dx.doi.org/10.1111/j.1547-5069.2006.00100.x>
34. Wilczynski NL, Haynes RB. EMBASE search strategies achieved high sensitivity and specificity for retrieving methodologically sound systematic reviews. *J Clin Epidemiol* 2007;**60**:29–33. <http://dx.doi.org/10.1016/j.jclinepi.2006.04.001>
35. Wong SS, Wilczynski NL, Haynes RB. Developing optimal search strategies for detecting clinically sound treatment studies in EMBASE. *J Med Libr Assoc* 2006;**94**:41–7.
36. Lefebvre C, Manheimer E, Glanville J. Chapter 6: Searching for Studies. In Higgins JPT, Green S, editors. *Cochrane Handbook for Systematic Reviews of Interventions*. Version 5.1.0 (updated March 2011). URL: [www.cochrane-handbook.org](http://www.cochrane-handbook.org) (accessed 10 August 2011).
37. Golder S, McIntosh HM, Duffy S, Glanville J. Developing efficient search strategies to identify reports of adverse effects in MEDLINE and EMBASE. *Health Info Libr J* 2006;**23**:3–12. <http://dx.doi.org/10.1111/j.1471-1842.2006.00634.x>
38. National Institute for Health and Care Excellence. *Abatacept for the Treatment of Rheumatoid Arthritis After the Failure of Conventional Disease Modifying Anti-Rheumatic Drugs*. TA234; 2011. URL: [www.nice.org.uk/guidance/ta234](http://www.nice.org.uk/guidance/ta234) (accessed 5 July 2013).
39. Information Services, Canadian Agency for Drugs and Technologies in Health (CADTH). *Grey Matters: A Practical Search Tool for Evidence-Based Medicine*. Ottawa, ON: CADTH; 2013.
40. National Institute for Health and Care Excellence. *Adalimumab, Etanercept, Infliximab, Certolizumab Pegol, Golimumab, Abatacept and Tocilizumab for the Treatment of Rheumatoid Arthritis (Review of TA Guidance 130, 186, 224, 234 and Part Review of TA Guidance 225 and 247) Final scope*. 2012. URL: [www.nice.org.uk/guidance/TA375/documents/rheumatoid-arthritis-adalimumab-etanercept-infliximab-certolizumab-pegol-golimumab-abatacept-and-tocilizumab-review-final-scope-2](http://www.nice.org.uk/guidance/TA375/documents/rheumatoid-arthritis-adalimumab-etanercept-infliximab-certolizumab-pegol-golimumab-abatacept-and-tocilizumab-review-final-scope-2) (accessed 5 July 2013).
41. Electronic Medicines Compendium. *Summary of Product Characteristics – Cimzia (Certolizumab)*; 2013. URL: [www.medicines.org.uk/emc/medicine/22323/SPC/Cimzia+200+mg+solution+for+injection/](http://www.medicines.org.uk/emc/medicine/22323/SPC/Cimzia+200+mg+solution+for+injection/) (accessed 5 July 2013).
42. Electronic Medicines Compendium. *Summary of Product Characteristics – Enbrel (Etanercept)*; 2012. URL: [www.medicines.org.uk/emc/searchresults.aspx?term=Enbrel&searchtype=QuickSearch](http://www.medicines.org.uk/emc/searchresults.aspx?term=Enbrel&searchtype=QuickSearch) (accessed 5 July 2013).

43. Electronic Medicines Compendium. *Summary of Product Characteristics – HUMIRA (Adalimumab)*; 2013. URL: [www.medicines.org.uk/emc/medicine/21201/SPC/Humira+Pre-filled+Pen%2c+Pre-filled+Syringe+and+Vial/](http://www.medicines.org.uk/emc/medicine/21201/SPC/Humira+Pre-filled+Pen%2c+Pre-filled+Syringe+and+Vial/) (accessed 5 July 2013).
44. Electronic Medicines Compendium. *Summary of Product Characteristics – Orenzia® (Abatacept)*; 2012. URL: [www.medicines.org.uk/emc/medicine/27216/SPC/ORENCIA+125+mg+solution+for+injection+\(pre-filled+syringe\)/](http://www.medicines.org.uk/emc/medicine/27216/SPC/ORENCIA+125+mg+solution+for+injection+(pre-filled+syringe)/) (accessed 5 July 2013).
45. Electronic Medicines Compendium. *Summary of Product Characteristics – Remicade (Infliximab)*; 2013. URL: [www.medicines.org.uk/emc/medicine/3236/SPC/Remicade+100mg+powder+for+concentrate+for+solution+for+infusion/](http://www.medicines.org.uk/emc/medicine/3236/SPC/Remicade+100mg+powder+for+concentrate+for+solution+for+infusion/) (accessed 5 July 2013).
46. Electronic Medicines Compendium. *Summary of Product Characteristics – Simponi (Golimumab)*; 2013. URL: [www.medicines.org.uk/emc/medicine/23766/SPC/Simponi+50+mg+solution+for+injection/](http://www.medicines.org.uk/emc/medicine/23766/SPC/Simponi+50+mg+solution+for+injection/) (accessed 5 July 2013).
47. Electronic Medicines Compendium. *Summary of Product Characteristics. RoActemra (Tocilizumab)*; 2013. URL: [www.medicines.org.uk/emc/medicine/22311/SPC/RoActemra+20mg+ml+Concentrate+for+Solution+for+Infusion/](http://www.medicines.org.uk/emc/medicine/22311/SPC/RoActemra+20mg+ml+Concentrate+for+Solution+for+Infusion/) (accessed 5 July 2013).
48. Centre for Reviews and Dissemination. *Systematic Reviews: CRD's Guidance for Undertaking Systematic Reviews in Health Care*. York: University of York; 2009.
49. Higgins JPT, Green S, editors. *Cochrane Handbook for Systematic Reviews of Interventions*. Version 5.1.0 (updated March 2011). The Cochrane Collaboration; 2011. URL: <http://handbook.cochrane.org/> (accessed 2 August 2013).
50. Karsh J, Keystone EC, Haraoui B, Thorne JC, Pope JE, Bykerk VP, et al. Canadian recommendations for clinical trials of pharmacologic interventions in rheumatoid arthritis: inclusion criteria and study design. *J Rheumatol* 2011;**38**:2095–104. <http://dx.doi.org/10.3899/jrheum.110188>
51. Thorlund K, Druyts E, Avina-Zubieta JA, Wu P, Mills EJ. Why the findings of published multiple treatment comparison meta-analyses of biologic treatments for rheumatoid arthritis are different: an overview of recurrent methodological shortcomings. *Ann Rheum Dis* 2012;**72**:1524–35. <http://dx.doi.org/10.1136/annrheumdis-2012-201574>
52. Dias S, Welton N, Sutton A, Ades A. *NICE DSU Technical Support Document 2: A Generalised Linear Modelling Framework for Pairwise and Network Meta-Analysis of Randomised Controlled Trials*. London: NICE; 2011.
53. Moreland LW, O'Dell JR, Paulus HE, Curtis JR, Bathon JM, Clair EW, et al. A randomised comparative effectiveness study of oral triple therapy versus etanercept plus methotrexate in early aggressive rheumatoid arthritis: the treatment of early aggressive rheumatoid arthritis trial. *Arthritis Rheum* 2012;**64**:2824–35. <http://dx.doi.org/10.1002/art.34498>
54. Klareskog L, van der Heijde D, de Jager JP, Gough A, Kalden J, Malaise M, et al. Therapeutic effect of the combination of etanercept and methotrexate compared with each treatment alone in patients with rheumatoid arthritis: double-blind randomised controlled trial. *Lancet* 2004;**363**:675–81. [http://dx.doi.org/10.1016/S0140-6736\(04\)15640-7](http://dx.doi.org/10.1016/S0140-6736(04)15640-7)
55. Jones G, Sebba A, Gu J, Lowenstein MB, Calvo A, Gomez-Reino JJ, et al. Comparison of tocilizumab monotherapy versus methotrexate monotherapy in patients with moderate to severe rheumatoid arthritis: the AMBITION study. *Ann Rheum Dis* 2010;**69**:88–96. <http://dx.doi.org/10.1136/ard.2008.105197>
56. Abe T, Takeuchi T, Miyasaka N, Hashimoto H, Kondo H, Ichikawa Y, et al. A multicenter, double-blind, randomised, placebo controlled trial of infliximab combined with low dose methotrexate in Japanese patients with rheumatoid arthritis. *J Rheumatol* 2006;**33**:37–44.



57. Dougados M, Kissel K, Sheeran T, Tak PP, Conaghan PG, Mola EM, *et al.* Adding tocilizumab or switching to tocilizumab monotherapy in methotrexate inadequate responders: 24-week symptomatic and structural results of a 2-year randomised controlled strategy trial in rheumatoid arthritis (ACT-RAY). *Ann Rheum Dis* 2013;**72**:43–50. <http://dx.doi.org/10.1136/annrheumdis-2011-201282>
58. Gabay C, Emery P, van Vollenhoven R, Dikranian A, Alten R, Pavelka K, *et al.* Tocilizumab monotherapy versus adalimumab monotherapy for treatment of rheumatoid arthritis (ADACTA): a randomised, double-blind, controlled phase 4 trial. *Lancet* 2013;**381**:1541–50. [http://dx.doi.org/10.1016/S0140-6736\(13\)60250-0](http://dx.doi.org/10.1016/S0140-6736(13)60250-0)
59. van Riel PL, Taggart AJ, Sany J, Gaubitz M, Nab HW, Pedersen R, *et al.* Efficacy and safety of combination etanercept and methotrexate versus etanercept alone in patients with rheumatoid arthritis with an inadequate response to methotrexate: the ADORE study. *Ann Rheum Dis* 2006;**65**:1478–83. <http://dx.doi.org/10.1136/ard.2005.043299>
60. van Riel PL, Freundlich B, MacPeck D, Pedersen R, Foehl JR, Singh A. Patient-reported health outcomes in a trial of etanercept monotherapy versus combination therapy with etanercept and methotrexate for rheumatoid arthritis: the ADORE trial. *Ann Rheum Dis* 2008;**67**:1104–10. <http://dx.doi.org/10.1136/ard.2006.068585>
61. Russell AS, Wallenstein GV, Li T, Martin MC, MacLean R, Blaisdell B, *et al.* Abatacept improves both the physical and mental health of patients with rheumatoid arthritis who have inadequate response to methotrexate treatment. *Ann Rheum Dis* 2007;**66**:189–94. <http://dx.doi.org/10.1136/ard.2006.057018>
62. Kremer JM, Genant HK, Moreland LW, Russell AS, Emery P, Abud-Mendoza C, *et al.* Effects of abatacept in patients with methotrexate-resistant active rheumatoid arthritis: a randomised trial. *Ann Intern Med* 2006;**144**:865–76. <http://dx.doi.org/10.7326/0003-4819-144-12-200606200-00003>
63. Kremer J, Russell AS, Westhovens R, Teng J, Rosenblatt L, Emery P. Sustained and clinically meaningful improvements in both day-and night-time aspects of HRQoL are observed with abatacept treatment in patients with rheumatoid arthritis (RA) and previous inadequate response to MTX: 5-year data from the AIM trial. *Arthritis Rheum* 2010;**62**:1836.
64. Kremer JM, Genant HK, Moreland LW, Russell AS, Emery P, Abud-Mendoza C, *et al.* Results of a two-year followup study of patients with rheumatoid arthritis who received a combination of abatacept and methotrexate. *Arthritis Rheum* 2008;**58**:953–63. <http://dx.doi.org/10.1002/art.23397>
65. Kremer JM, Russell AS, Emery P, Abud-Mendoza C, Szechinski J, Westhovens R, *et al.* Long-term safety, efficacy and inhibition of radiographic progression with abatacept treatment in patients with rheumatoid arthritis and an inadequate response to methotrexate: 3-year results from the AIM trial. *Ann Rheum Dis* 2011;**70**:1826–30. <http://dx.doi.org/10.1136/ard.2010.139345>
66. Fleischmann R, Schiff MH, Weinblatt ME, Maldonado MA, Massarotti EM, Yazici Y. Effects of subcutaneous abatacept or adalimumab on remission and associated changes in physical function and radiographic outcomes: one year results from the ample (abatacept versus adalimumab comparison in biologic-naive RA subjects with background methotrexate) trial. *Arthritis Rheum* 2012;**64**:S577.
67. Kim H-Y, Hsu P-N, Barba M, Sulaiman W, Robertson D, Vlahos B, *et al.* Randomised comparison of etanercept with usual therapy in an Asian population with active rheumatoid arthritis: the APPEAL trial. *Int J Rheum Dis* 2012;**15**:188–96. <http://dx.doi.org/10.1111/j.1756-185X.2011.01680.x>

68. Bae SC, Gun SC, Mok CC, Khandker R, Nab HW, Koenig AS, *et al.* Improved health outcomes with Etanercept versus usual DMARD therapy in an Asian population with established rheumatoid arthritis. *BMC Musculoskelet Disord* 2013;**14**:13. <http://dx.doi.org/10.1186/1471-2474-14-13>
69. Weinblatt ME, Keystone EC, Furst DE, Moreland LW, Weisman MH, Birbara CA, *et al.* Adalimumab, a fully human anti-tumour necrosis factor alpha monoclonal antibody, for the treatment of rheumatoid arthritis in patients taking concomitant methotrexate: the ARMADA trial. *Arthritis Rheum* 2003;**48**:35–45. <http://dx.doi.org/10.1002/art.10697>
70. Weinblatt ME, Keystone EC, Furst DE, Kavanaugh AF, Chartash EK, Segurado OG. Long term efficacy and safety of adalimumab plus methotrexate in patients with rheumatoid arthritis: ARMADA 4 year extended study. *Ann Rheum Dis* 2006;**65**:753–9. <http://dx.doi.org/10.1136/ard.2005.044404>
71. St Clair EW, van der Heijde DMFM, Smolen JS, Maini RN, Bathon JM, Emery P, *et al.* Combination of infliximab and methotrexate therapy for early rheumatoid arthritis: a randomised, controlled trial. *Arthritis Rheum* 2004;**50**:3432–43. <http://dx.doi.org/10.1002/art.20568>
72. Conaghan P, Durez P, Alten RE, Burmester GR, Tak PP, Klareskog L, *et al.* Impact of intravenous abatacept on synovitis, osteitis and structural damage in patients with rheumatoid arthritis and an inadequate response to methotrexate: the ASSET randomised controlled trial. *Ann Rheum Dis* 2013;**72**:1287–94. <http://dx.doi.org/10.1136/annrheumdis-2012-201611>
73. Weinblatt M, Combe B, Covucci A, Aranda R, Becker JC, Keystone E. Safety of the selective costimulation modulator abatacept in rheumatoid arthritis patients receiving background biologic and nonbiologic disease-modifying antirheumatic drugs: a one-year randomised, placebo-controlled study. *Arthritis Rheum* 2006;**54**:2807–16. <http://dx.doi.org/10.1002/art.22070>
74. Schiff M, Keiserman M, Coddling C, Songcharoen S, Berman A, Nayiager S, *et al.* Efficacy and safety of abatacept or infliximab vs placebo in ATTEST: a phase III, multi-centre, randomised, double-blind, placebo-controlled study in patients with rheumatoid arthritis and an inadequate response to methotrexate. *Ann Rheum Dis* 2008;**67**:1096–103. <http://dx.doi.org/10.1136/ard.2007.080002>
75. Maini R, St Clair EW, Breedveld F, Furst D, Kalden J, Weisman M, *et al.* Infliximab (chimeric anti-tumour necrosis factor alpha monoclonal antibody) versus placebo in rheumatoid arthritis patients receiving concomitant methotrexate: a randomised phase III trial. *Lancet* 1999;**354**:1932–9. [http://dx.doi.org/10.1016/S0140-6736\(99\)05246-0](http://dx.doi.org/10.1016/S0140-6736(99)05246-0)
76. van Vollenhoven RF, Kinnman N, Vincent E, Wax S, Bathon J. Atacicept in patients with rheumatoid arthritis and an inadequate response to methotrexate: results of a phase II, randomised, placebo-controlled trial. *Arthritis Rheum* 2011;**63**:1782–92. <http://dx.doi.org/10.1002/art.30372>
77. Bejarano V, Quinn M, Conaghan PG, Reece R, Keenan A-M, Walker D, *et al.* Effect of the early use of the anti-tumour necrosis factor adalimumab on the prevention of job loss in patients with early rheumatoid arthritis. *Arthrit Care Res* 2008;**59**:1467–74. <http://dx.doi.org/10.1002/art.24106>
78. Goekoop-Ruiterman YP, de Vries-Bouwstra JK, Allaart CF, van ZD, Kerstens PJ, Hazes JM, *et al.* Clinical and radiographic outcomes of four different treatment strategies in patients with early rheumatoid arthritis (the BeST study): a randomised, controlled trial. *Arthritis Rheum* 2008;**52**:3381–90. <http://dx.doi.org/10.1002/art.21405>
79. Smolen J, Emery P, Ferraccioli G. Efficacy and safety of certolizumab pegol after incomplete response to DMARDS in RA patients with low moderate disease activity: results from certain, a phase IIIb study. *Ann Rheum Dis* 2011;**70**:S259. <http://dx.doi.org/10.1136/annrheumdis-2013-204632>

80. Miyasaka N. Clinical investigation in highly disease-affected rheumatoid arthritis patients in Japan with adalimumab applying standard and general evaluation: the CHANGE study. *Mod Rheumatol* 2008;**18**:252–62. <http://dx.doi.org/10.3109/s10165-008-0045-0>
81. Emery P, Breedveld FC, Hall S, Durez P, Chang DJ, Robertson D, *et al.* Comparison of methotrexate monotherapy with a combination of methotrexate and etanercept in active, early, moderate to severe rheumatoid arthritis (COMET): a randomised, double-blind, parallel treatment trial. *Lancet* 2008;**372**:375–82. [http://dx.doi.org/10.1016/S0140-6736\(08\)61000-4](http://dx.doi.org/10.1016/S0140-6736(08)61000-4)
82. Emery P, Breedveld F, van der Heijde D, Ferraccioli G, Dougados M, Robertson D, *et al.* Two-year clinical and radiographic results with combination etanercept-methotrexate therapy versus monotherapy in early rheumatoid arthritis: a two-year, double-blind, randomised study. *Arthritis Rheum* 2010;**62**:674–82. <http://dx.doi.org/10.1002/art.27268>
83. Kekow J, Moots RJ, Emery P, Durez P, Koenig A, Singh A, *et al.* Patient-reported outcomes improve with etanercept plus methotrexate in active early rheumatoid arthritis and the improvement is strongly associated with remission: the COMET trial. *Ann Rheum Dis* 2010;**69**:222–5. [Erratum appears in *Ann Rheum Dis* 2011;**70**:1519.] <http://dx.doi.org/10.1136/ard.2008.102509>
84. Keystone EC, Kavanaugh AF, Sharp JT, Tannenbaum H, Hua Y, Teoh LS, *et al.* Radiographic, clinical, and functional outcomes of treatment with adalimumab (a human anti-tumour necrosis factor monoclonal antibody) in patients with active rheumatoid arthritis receiving concomitant methotrexate therapy: a randomised, placebo-controlled, 52-week trial. *Arthritis Rheum* 2004;**50**:1400–11. <http://dx.doi.org/10.1002/art.20217>
85. deFilippis L, Caliri A, Anghelone S, Scibilia G, Lo Gullo R, Bagnato G. Improving outcomes in tumour necrosis factor a treatment: comparison of the efficacy of the tumour necrosis factor a blocking agents etanercept and infliximab in patients with active rheumatoid arthritis. *Panminerva Med* 2006;**48**:129–35.
86. Durez P, Nzesuseu TA, Lauwerys BR, Manicourt DH, Verschueren P, Westhovens R, *et al.* A randomised comparative study of the short term clinical and biological effects of intravenous pulse methylprednisolone and infliximab in patients with active rheumatoid arthritis despite methotrexate treatment. *Ann Rheum Dis* 2004;**63**:1069–74. <http://dx.doi.org/10.1136/ard.2003.012914>
87. Bathon JM, Martin RW, Fleischmann RM, Tesser JR, Schiff MH, Keystone EC, *et al.* A comparison of etanercept and methotrexate in patients with early rheumatoid arthritis. *N Engl J Med* 2000;**343**:1586–93. <http://dx.doi.org/10.1056/NEJM200011303432201>
88. Combe B, Codreanu C, Fiocco U, Gaubitz M, Geusens PP, Kvien TK, *et al.* Etanercept and sulfasalazine, alone and combined, in patients with active rheumatoid arthritis despite receiving sulfasalazine: a double-blind comparison. *Ann Rheum Dis* 2006;**65**:1357–62. <http://dx.doi.org/10.1136/ard.2005.049650>
89. Combe B, Codreanu C, Fiocco U, Gaubitz M, Geusens PP, Kvien TK, *et al.* Efficacy, safety and patient-reported outcomes of combination etanercept and sulfasalazine versus etanercept alone in patients with rheumatoid arthritis: a double-blind randomised 2-year study. *Ann Rheum Dis* 2009;**68**:1146–52. <http://dx.doi.org/10.1136/ard.2007.087106>
90. Emery P, Fleischmann RM, Moreland LW, Hsia EC, Strusberg I, Durez P, *et al.* Golimumab, a human anti-tumour necrosis factor alpha monoclonal antibody, injected subcutaneously every four weeks in methotrexate-naive patients with active rheumatoid arthritis: twenty-four-week results of a phase III, multicenter, randomised, double-blind, placebo-controlled study of golimumab before methotrexate as first-line therapy for early-onset rheumatoid arthritis. *Arthritis Rheum* 2009;**60**:2272–83. <http://dx.doi.org/10.1002/art.24638>

91. Tanaka Y, Harigai M, Takeuchi T, Yamanaka H, Ishiguro N, Yamamoto K, *et al.* Golimumab in combination with methotrexate in Japanese patients with active rheumatoid arthritis: results of the GO-FORTH study. *Ann Rheum Dis* 2012;**71**:817–24. <http://dx.doi.org/10.1136/ard.2011.200317>
92. Keystone E, Genovese MC, Klareskog L, Hsia EC, Hall S, Miranda PC, *et al.* Golimumab in patients with active rheumatoid arthritis despite methotrexate therapy: 52-week results of the GO-FORWARD study. *Ann Rheum Dis* 2010;**69**:1129–35. <http://dx.doi.org/10.1136/ard.2009.116319>
93. Soubrier M, Puechal X, Sibilia J, Mariette X, Meyer O, Combe B, *et al.* Evaluation of two strategies (initial methotrexate monotherapy vs its combination with adalimumab) in management of early active rheumatoid arthritis: data from the GUEPARD trial. *Rheumatology* 2009;**48**:1429–34. <http://dx.doi.org/10.1093/rheumatology/kep261>
94. Detert J, Bastian H, Listing J, Weis A, Wassenberg S, Liebhaber A, *et al.* Induction therapy with adalimumab plus methotrexate for 24 weeks followed by methotrexate monotherapy up to week 48 versus methotrexate therapy alone for DMARD-naïve patients with early rheumatoid arthritis: HIT HARD, an investigator-initiated study. *Ann Rheum Dis* 2013;**72**:844–50. <http://dx.doi.org/10.1136/annrheumdis-2012-201612>
95. Nam JL, Villeneuve E, Conaghan PG, Hensor E, Keen HI, Amarasena R, *et al.* A preliminary report of remission induction with two therapeutic strategies with infliximab or high dose intravenous steroids for the treatment of rheumatoid arthritis. *Arthritis Rheum* 2011;**63**(Suppl. 10):463.
96. Keystone EC, Wang MM, Layton M, Hollis S, McInnes IB, Study Team. Clinical evaluation of the efficacy of the P2X7 purinergic receptor antagonist AZD9056 on the signs and symptoms of rheumatoid arthritis in patients with active disease despite treatment with methotrexate or sulphasalazine. *Ann Rheum Dis* 2012;**71**:1630–5. [Erratum appears in *Ann Rheum Dis* 2012;**71**:2064.] <http://dx.doi.org/10.1136/annrheumdis-2011-143578>
97. Kameda H, Ueki Y, Saito K, Nagaoka S, Hidaka T, Atsumi T, *et al.* Etanercept (ETN) with methotrexate (MTX) is better than ETN monotherapy in patients with active rheumatoid arthritis despite MTX therapy: a randomised trial. *Mod Rheumatol* 2010;**20**:531–8. <http://dx.doi.org/10.3109/s10165-010-0324-4>
98. Kay J, Matteson EL, Dasgupta B, Nash P, Durez P, Hall S, *et al.* Golimumab in patients with active rheumatoid arthritis despite treatment with methotrexate: a randomised, double-blind, placebo-controlled, dose-ranging study. *Arthritis Rheum* 2008;**58**:964–75. <http://dx.doi.org/10.1002/art.23383>
99. Kim H-Y, Lee S-K, Song YW, Yoo D-H, Koh E-M, Yoo B, *et al.* A randomised, double-blind, placebo-controlled, phase III study of the human anti-tumour necrosis factor antibody adalimumab administered as subcutaneous injections in Korean rheumatoid arthritis patients treated with methotrexate. *Int J Rheum Dis* 2007;**10**:9–16.
100. Kume K, Amano K, Yamada S, Hatta K, Ohta H, Kuwaba N. Tocilizumab monotherapy reduces arterial stiffness as effectively as etanercept or adalimumab monotherapy in rheumatoid arthritis: an open-label randomised controlled trial. *J Rheumatol* 2011;**38**:2169–71. <http://dx.doi.org/10.3899/jrheum.110340>
101. Lan J-L, Chou S-J, Chen D-Y, Chen Y-H, Hsieh T-Y, Young J. A comparative study of etanercept plus methotrexate and methotrexate alone in Taiwanese patients with active rheumatoid arthritis: a 12-week, double-blind, randomised, placebo-controlled study. *J Formos Med Assoc* 2004;**103**:618–23.

102. Machado D, Guzman R, Xavier R, Simon J, Ferdousi T, Pedersen R, *et al.* Combination Etanercept and Methotrexate Therapy Provides Better Outcomes Than Standard DMARD and Methotrexate Therapy in Rheumatoid Arthritis: Results From a Study in the Latin America Region. Presented at XVII Congress of Pan American League of Associations of Rheumatology (PANLAR); Punta Cana, Dominican Republic; 17–21 April 2012.
103. McInnes I, Lee JS, Wu W, Giles JT, Bathon JM, Salmon JE, *et al.* MEASURE: a translational, randomised, placebo (PBO)-controlled study to evaluate the effects of tocilizumab (TCZ) on parameters of lipids and inflammation. *Ann Rheum Dis* 2011;**70**:S73.
104. Moreland LW, Schiff MH, Baumgartner SW, Tindall EA, Fleischmann RM, Bulpitt KJ, *et al.* Etanercept therapy in rheumatoid arthritis: a randomised, controlled trial. *Ann Intern Med* 1999;**130**:478–86. <http://dx.doi.org/10.7326/0003-4819-130-6-199903160-00004>
105. Mathias SD, Colwell HH, Miller DP, Moreland LW, Buatti M, Wanke L. Health-related quality of life and functional status of patients with rheumatoid arthritis randomly assigned to receive etanercept or placebo. *Clin Ther* 2000;**22**:128–39. [http://dx.doi.org/10.1016/S0149-2918\(00\)87984-9](http://dx.doi.org/10.1016/S0149-2918(00)87984-9)
106. Nishimoto N, Yoshizaki K, Miyasaka N, Yamamoto K, Kawai S, Takeuchi T, *et al.* Treatment of rheumatoid arthritis with humanised anti-interleukin-6 receptor antibody: a multicenter, double-blind, placebo-controlled trial. *Arthritis Rheum* 2004;**50**:1761–9. <http://dx.doi.org/10.1002/art.20303>
107. Hørslev-Petersen K. Adalimumab added to a treat-to-target strategy with methotrexate and intra-articular triamcinolone in early rheumatoid arthritis increased remission rates, function and quality of life. The OPERA study: an investigator-initiated, randomised, double-blind, parallel-group, placebo-controlled trial. *Ann Rheum Dis* 2014;**73**:654–61. <http://dx.doi.org/10.1136/annrheumdis-2012-202735>
108. Kavanaugh A, Fleischmann RM, Emery P, Kupper H, Redden L, Guertte B, *et al.* Clinical, functional and radiographic consequences of achieving stable low disease activity and remission with adalimumab plus methotrexate or methotrexate alone in early rheumatoid arthritis: 26-week results from the randomised, controlled OPTIMA study. *Ann Rheum Dis* 2013;**72**:64–71. <http://dx.doi.org/10.1136/annrheumdis-2011-201247>
109. Breedveld FC, Weisman MH, Kavanaugh AF, Cohen SB, Pavelka K, van Vollenhoven R, *et al.* The PREMIER study: a multicenter, randomised, double-blind clinical trial of combination therapy with adalimumab plus methotrexate versus methotrexate alone or adalimumab alone in patients with early, aggressive rheumatoid arthritis who had not had previous methotrexate treatment. *Arthritis Rheum* 2006;**54**:26–37. <http://dx.doi.org/10.1002/art.21519>
110. Quinn MA, Conaghan PG, O'Connor PJ, Karim Z, Greenstein A, Brown A, *et al.* Very early treatment with infliximab in addition to methotrexate in early, poor-prognosis rheumatoid arthritis reduces magnetic resonance imaging evidence of synovitis and damage, with sustained benefit after infliximab withdrawal: results from a twelve-month randomised, double-blind, placebo-controlled trial. *Arthritis Rheum* 2005;**52**:27–35. <http://dx.doi.org/10.1002/art.20712>
111. O'Dell JR, Mikuls TR, Taylor T, Ahluwalia V, Brophy M, Warren S, *et al.* Rheumatoid arthritis comparison of active therapies in methotrexate suboptimal responders: validation of the strategy of conventional disease modifying anti-rheumatic drugs before biologicals. *Arthritis Rheum* 2012;**64**:S1297.
112. O'Dell JR, Mikuls TR, Taylor TH, Ahluwalia V, Brophy M, Warren SR, *et al.* Therapies for active rheumatoid arthritis after methotrexate failure. *N Engl J Med* 2013;**369**:307–18. <http://dx.doi.org/10.1056/NEJMoa1303006>

113. Weinblatt ME, Fleischmann R, van Vollenhoven R, Emery P, Huizinga TWJ, Goldermann R, *et al.* Certolizumab pegol in patients with active rheumatoid arthritis aligned with NICE guidance for anti-TNF therapy: post-HOC analyses of the realistic phase IIIB randomised controlled study. *Rheumatology* 2012;**51**(Suppl. 3):abstract 200.
114. Jobanputra P, Maggs F, Deeming A, Carruthers D, Rankin E, Jordan AC, *et al.* A randomised efficacy and discontinuation study of etanercept versus adalimumab (RED SEA) for rheumatoid arthritis: a pragmatic, unblinded, non-inferiority study of first TNF inhibitor use: outcomes over 2 years. *BMJ Open* 2012;**2**:e001395. <http://dx.doi.org/10.1136/bmjopen-2012-001395>
115. Nishimoto N, Hashimoto J, Miyasaka N, Yamamoto K, Kawai S, Takeuchi T, *et al.* Study of active controlled monotherapy used for rheumatoid arthritis, an IL-6 inhibitor (SAMURAI): evidence of clinical and radiographic benefit from an X ray reader-blinded randomised controlled trial of tocilizumab. *Ann Rheum Dis* 2007;**66**:1162–7. <http://dx.doi.org/10.1136/ard.2006.068064>
116. Nishimoto N, Miyasaka N, Yamamoto K, Kawai S, Takeuchi T, Azuma J, *et al.* Study of active controlled tocilizumab monotherapy for rheumatoid arthritis patients with an inadequate response to methotrexate (SATORI): significant reduction in disease activity and serum vascular endothelial growth factor by IL-6 receptor inhibition therapy. *Mod Rheumatol* 2009;**19**:12–19. <http://dx.doi.org/10.3109/s10165-008-0125-1>
117. Furst DE, Schiff MH, Fleischmann RM, Strand V, Birbara CA, Compagnone D, *et al.* Adalimumab, a fully human anti-tumour necrosis factor-alpha monoclonal antibody, and concomitant standard antirheumatic therapy for the treatment of rheumatoid arthritis: results of star (safety trial of adalimumab in rheumatoid arthritis). *J Rheumatol* 2003;**30**:2563–71.
118. Westhovens R, Yocum D, Han J, Berman A, Strusberg I, Geusens P, *et al.* The safety of infliximab, combined with background treatments, among patients with rheumatoid arthritis and various comorbidities: a large, randomised, placebo-controlled trial. *Arthritis Rheum* 2006;**54**:1075–86. <http://dx.doi.org/10.1002/art.21734>
119. van Vollenhoven RF, Ernestam S, Geborek P, Petersson IF, Coster L, Waltbrand E, *et al.* Addition of infliximab compared with addition of sulfasalazine and hydroxychloroquine to methotrexate in patients with early rheumatoid arthritis (Swefot trial): 1-year results of a randomised trial. *Lancet* 2009;**374**:459–66. [http://dx.doi.org/10.1016/S0140-6736\(09\)60944-2](http://dx.doi.org/10.1016/S0140-6736(09)60944-2)
120. Durez P, Malghem J, Toukap AN, Depresseux G, Lauwerys BR, Westhovens R, *et al.* Treatment of early rheumatoid arthritis: a randomised magnetic resonance imaging study comparing the effects of methotrexate alone, methotrexate in combination with infliximab, and methotrexate in combination with intravenous pulse methylprednisolone. *Arthritis Rheum* 2007;**56**:3919–27. <http://dx.doi.org/10.1002/art.23055>
121. Genovese MC, McKay JD, Nasonov EL, Mysler EF, da Silva NA, Alecock E, *et al.* Interleukin-6 receptor inhibition with tocilizumab reduces disease activity in rheumatoid arthritis with inadequate response to disease-modifying antirheumatic drugs: the tocilizumab in combination with traditional disease-modifying antirheumatic drug therapy study. *Arthritis Rheum* 2008;**58**:2968–80. <http://dx.doi.org/10.1002/art.23940>
122. Van De Putte LBA, Atkins C, Malaise M, Sany J, Russell AS, Van Riel PLCM, *et al.* Efficacy and safety of adalimumab as monotherapy in patients with rheumatoid arthritis for whom previous disease modifying antirheumatic drug treatment has failed. *Ann Rheum Dis* 2004;**63**:508–16. <http://dx.doi.org/10.1136/ard.2003.013052>
123. Chen YF, Jobanputra P, Barton P, Jowett S, Bryan S, Clark W, *et al.* A systematic review of the effectiveness of adalimumab, etanercept and infliximab for the treatment of rheumatoid arthritis in adults and an economic evaluation of their cost-effectiveness. *Health Technol Assess* 2006;**10**(42). <http://dx.doi.org/10.3310/hta10420>

124. Weinblatt ME, Kremer JM, Bankhurst AD, Bulpitt KJ, Fleischmann RM, Fox RI, *et al.* A trial of etanercept, a recombinant tumour necrosis factor receptor: Fc fusion protein, in patients with rheumatoid arthritis receiving methotrexate. *N Engl J Med* 1999;**340**:253–9. <http://dx.doi.org/10.1056/NEJM199901283400401>
125. Wong M, Oakley SP, Young L, Jiang BY, Wierzbicki A, Panayi G, *et al.* Infliximab improves vascular stiffness in patients with rheumatoid arthritis. *Ann Rheum Dis* 2009;**68**:1277–84. <http://dx.doi.org/10.1136/ard.2007.086157>
126. Zhang F-C, Hou Y, Huang F, Wu D-H, Bao C-D, Ni L-Q, *et al.* Infliximab versus placebo in rheumatoid arthritis patients receiving concomitant methotrexate: a preliminary study from China. *Int J Rheum Dis* 2006;**9**:127–30. <http://dx.doi.org/10.1111/j.1479-8077.2006.00186.x>
127. Genovese MC, Covarrubias A, Leon G, Mysler E, Keiserman M, Valente R, *et al.* Subcutaneous abatacept versus intravenous abatacept: a phase IIIb noninferiority study in patients with an inadequate response to methotrexate. *Arthritis Rheum* 2011;**63**:2854–64. <http://dx.doi.org/10.1002/art.30463>
128. Jones G. The AMBITION trial: tocilizumab monotherapy for rheumatoid arthritis. *Expert Rev Clin Immunol* 2010;**6**:189–95. <http://dx.doi.org/10.1586/eci.10.2>
129. Yamamoto K, Takeuchi T, Yamanaka H, Ishiguro N, Tanaka Y, Eguchi K, *et al.* *Efficacy and Safety of Certolizumab Pegol Plus Methotrexate in Japanese Rheumatoid Arthritis Patients with an Inadequate Response to Methotrexate.* Arthritis and Rheumatism Conference: Annual Scientific Meeting of the American College of Rheumatology and Association of Rheumatology Health Professionals, October 2011, Chicago, IL, USA.
130. Kremer JM, Blanco R, Brzosko M, Burgos-Vargas R, Halland A-M, Vernon E, *et al.* Tocilizumab inhibits structural joint damage in rheumatoid arthritis patients with inadequate responses to methotrexate: results from the double-blind treatment phase of a randomised placebo-controlled trial of tocilizumab safety and prevention of structural joint damage at one year. *Arthritis Rheum* 2011;**63**:609–21. <http://dx.doi.org/10.1002/art.30158>
131. Kremer JM, Dougados M, Emery P, Durez P, Sibia J, Shergy W, *et al.* Treatment of rheumatoid arthritis with the selective costimulation modulator abatacept: twelve-month results of a phase IIb, double-blind, randomised, placebo-controlled trial. *Arthritis Rheum* 2005;**52**:2263–71. <http://dx.doi.org/10.1002/art.21201>
132. Smolen JS, Beaulieu A, Rubbert-Roth A, Ramos-Remus C, Rovensky J, Alecock E, *et al.* Effect of interleukin-6 receptor inhibition with tocilizumab in patients with rheumatoid arthritis (OPTION study): a double-blind, placebo-controlled, randomised trial. *Lancet* 2008;**371**:987–97. [http://dx.doi.org/10.1016/S0140-6736\(08\)60453-5](http://dx.doi.org/10.1016/S0140-6736(08)60453-5)
133. van Vollenhoven RF, Fleischmann R, Cohen S, Lee EB, Meijide JAG, Wagner S, *et al.* Tofacitinib or adalimumab versus placebo in rheumatoid arthritis. *N Engl J Med* 2012;**367**:508–19. <http://dx.doi.org/10.1056/NEJMoa1112072>
134. Kang Y, Park W, Park Y, Choe J, Bae S-C. Efficacy and safety of certolizumab pegol (CZP) with concomitant methotrexate (MTX) in Korean rheumatoid arthritis (RA) patients (PTS) with an inadequate response to MTX. *Ann Rheum Dis* 2012;**71**:666. <http://dx.doi.org/10.1136/annrheumdis-2012-eular.501>
135. Keystone E, van der Heijde D, Mason J, Landewe R, van Vollenhoven R, Combe B, *et al.* Certolizumab pegol plus methotrexate is significantly more effective than placebo plus methotrexate in active rheumatoid arthritis: findings of a fifty-two-week, phase III, multicenter, randomised, double-blind, placebo-controlled, parallel-group study. *Arthritis Rheum* 2008;**58**:3319–29. <http://dx.doi.org/10.1002/art.23964>

136. Smolen J, Landewe RB, Mease P, Brzezicki J, Mason D, Lijntens K, *et al.* Efficacy and safety of certolizumab pegol plus methotrexate in active rheumatoid arthritis: the RAPID 2 study. A randomised controlled trial. *Ann Rheum Dis* 2009;**68**:797–804. <http://dx.doi.org/10.1136/ard.2008.101659>
137. Kremer JM, Cohen S, Wilkinson BE, Connell CA, French JL, Gomez-Reino J, *et al.* A phase IIb dose-ranging study of the oral JAK inhibitor tofacitinib (CP-690,550) versus placebo in combination with background methotrexate in patients with active rheumatoid arthritis and an inadequate response to methotrexate alone. *Arthritis Rheum* 2012;**64**:970–81. <http://dx.doi.org/10.1002/art.33419>
138. van der Heijde D, Tanaka Y, Fleischmann R, Keystone E, Kremer J, Zerbini C, *et al.* Tofacitinib (CP-690,550) in patients with rheumatoid arthritis receiving methotrexate: twelve-month data from a twenty-four month phase III randomised radiographic study. *Arthritis Rheum* 2013;**65**:559–70. <http://dx.doi.org/10.1002/art.37816>
139. Bathon JM, Genovese MC. The Early Rheumatoid Arthritis (ERA) trial comparing the efficacy and safety of etanercept and methotrexate. *Clin Exp Rheumatol* 2003;**21**:S195–7.
140. Kameda H, Kanbe K, Sato E, Ueki Y, Saito K, Nagaoka S, *et al.* Continuation of methotrexate resulted in better clinical and radiographic outcomes than discontinuation upon starting etanercept in patients with rheumatoid arthritis: 52-week results from the JESMR study. *J Rheumatol* 2011;**38**:1585–92. <http://dx.doi.org/10.3899/jrheum.110014>
141. Scott DL, Ibrahim F, Farewell V, O’Keeffe AG, Ma M, Walker D, *et al.* Randomised controlled trial of tumour-necrosis-factor inhibitors against combination intensive therapy with conventional disease modifying anti-rheumatic drugs in established rheumatoid arthritis: the TACIT trial. *Health Technol Assess* 2013;**18**(66). <http://dx.doi.org/10.3310/hta18660>
142. Smolen J, Fleischmann R, Guerette B. Adalimumab plus methotrexate vs. methotrexate monotherapy for early rheumatoid arthritis: 26-week results (first phase) from the 78-week optima study. *Ann Rheum Dis* 2010;**69**:102. <http://dx.doi.org/10.1136/annrheumdis-2011-201247>
143. Fleischmann R, Emery P. Long-term efficacy and safety of golimumab, a human anti-TNF alpha monoclonal antibody, in methotrexate-naïve rheumatoid arthritis patients: results from the go-before study. *Ann Rheum Dis* 2010;**69**:681.
144. Weinblatt ME, Schiff M, Valente R, van der Heijde D, Citera G, Zhao C, *et al.* Head-to-head comparison of subcutaneous abatacept versus adalimumab for rheumatoid arthritis. *Arthritis Rheum* 2013;**65**:28–38. <http://dx.doi.org/10.1002/art.37711>
145. AstraZeneca. *A Randomised, Double-Blind (with Open Comparator Etanercept Limb), Placebo-Controlled, Phase IIb, Multicentre Study to Evaluate the Efficacy of 4 Doses of AZD9056 Administered for 6 Months on the Signs and Symptoms of Rheumatoid Arthritis in Patients with Active Disease Receiving Background Methotrexate or Sulphasalazine*. Clinical Study Report Synopsis. Drug substance AZD9056 hydrochloride. Study code D1520C00001. Edition 1; 2009. URL: [www.astrazenecaclinicaltrials.com/\\_mshost800325/content/clinical-trials/resources/pdf/10775953](http://www.astrazenecaclinicaltrials.com/_mshost800325/content/clinical-trials/resources/pdf/10775953) (accessed 8 August 2013).
146. Lipsky PE, van der Heijde DMFM, St Clair EW, Furst DE, Breedveld FC, Kalden JR, *et al.* Infliximab and methotrexate in the treatment of rheumatoid arthritis. *N Engl J Med* 2000;**343**:1594–602. <http://dx.doi.org/10.1056/NEJM200011303432202>
147. van Vollenhoven RF, Geborek P, Forslind K, Albertsson K, Ernestam S, Petersson IF, *et al.* Conventional combination treatment versus biological treatment in methotrexate-refractory early rheumatoid arthritis: 2 year follow-up of the randomised, non-blinded, parallel-group Swefot trial. *Lancet* 2012;**379**:1712–20. [http://dx.doi.org/10.1016/S0140-6736\(12\)60027-0](http://dx.doi.org/10.1016/S0140-6736(12)60027-0)



148. van der Kooij SM, de Vries-Bouwstra JK, Goekoop-Ruiterman YP, Ewals JA, Han KH, Hazes JM, *et al.* Patient-reported outcomes in a randomised trial comparing four different treatment strategies in recent-onset rheumatoid arthritis. *Arthritis Rheum* 2009;**61**:4–12. <http://dx.doi.org/10.1002/art.24367>
149. Boini S, Guillemin F. Radiographic scoring methods as outcome measures in rheumatoid arthritis: properties and advantages. *Ann Rheum Dis* 2001;**60**:817–27.
150. Peterfy C, Haraoui B, Durez P, Patra K, Kupper H. *Decreased Incidence of Synovitis, Osteitis, and Erosion in Early RA Patients Treated with Adalimumab Plus Methotrexate Compared to Those With Methotrexate Alone: High-Field MRI Analysis from OPTIMA*. Arthritis and Rheumatism Conference: American College of Rheumatology/Association of Rheumatology Health Professionals Annual Scientific Meeting 10, Philadelphia, PA, 2010.
151. Ostergaard M, Emery P, Conaghan PG, Fleischmann R, Hsia EC, Xu W, *et al.* Significant improvement in synovitis, osteitis, and bone erosion following golimumab and methotrexate combination therapy as compared with methotrexate alone: a magnetic resonance imaging study of 318 methotrexate-naïve rheumatoid arthritis patients. *Arthritis Rheum* 2011;**63**:3712–22. <http://dx.doi.org/10.1002/art.30592>
152. *Tocilizumab (RoActemra) for the Treatment of Rheumatoid Arthritis*. Roche MTA Submission. 2013.
153. Conaghan PG, Emery P, Ostergaard M, Keystone EC, Genovese MC, Hsia EC, *et al.* Assessment by MRI of inflammation and damage in rheumatoid arthritis patients with methotrexate inadequate response receiving golimumab: results of the GO-FORWARD trial. *Ann Rheum Dis* 2011;**70**:1968–74. <http://dx.doi.org/10.1136/ard.2010.146068>
154. Emery P, Kavanaugh AF, Smolen J, Cifaldi MA, Chaves L, Guerette B, *et al.* Combination Therapy With Adalimumab Methotrexate Significantly Improved Work Ability, Physical Function, Fatigue, and Other Patient-Reported Outcomes in Early Rheumatoid Arthritis: Results From a 26-Week Analysis. Arthritis and Rheumatism Conference: Annual Scientific Meeting of the American College of Rheumatology and Association of Rheumatology Health Professionals, Chicago, IL, 2011.
155. Strand V, Rentz AM, Cifaldi MA, Chen N, Roy S, Revicki D. Health-related quality of life outcomes of adalimumab for patients with early rheumatoid arthritis: results from a randomised multicenter study. *J Rheumatol* 2012;**39**:63–72. <http://dx.doi.org/10.3899/jrheum.101161>
156. Multiple Technology Appraisal. ID537. *Certolizumab Pegol for the Treatment of Rheumatoid Arthritis that has Previously Been Treated with Conventional Disease-Modifying Anti-Rheumatic Drugs*. UCB Pharma Submission. 2013.
157. Kosinski M, Kujawski SC, Martin R, Wanke LA, Buatti MC, Ware J, *et al.* Health-related quality of life in early rheumatoid arthritis: impact of disease and treatment response. *Am J Manag Care* 2002;**8**:231–40.
158. Allaart CF, Breedveld FC, Dijkmans BAC. Treatment of recent-onset rheumatoid arthritis: lessons from the BeSt study. *J Rheumatol* 2007;**34**:S25–33.
159. National Institute for Health and Care Excellence. *Adalimumab, Etanercept, Infliximab, Certolizumab, Golimumab, Abatacept, and Tocilizumab for the Treatment of Rheumatoid Arthritis (Review of TA Guidance 130, 186, 224, 234, and Part Review of TA Guidance 225 and 247) [ID537]*. Manufacturer submission of evidence: Infliximab (Remicade®). 2013.
160. Kremer JM, Weinblatt ME, Bankhurst AD, Bulpitt KJ, Fleischmann RM, Jackson CG, *et al.* Etanercept added to background methotrexate therapy in patients with rheumatoid arthritis: continued observations. *Arthritis Rheum* 2003;**48**:1493–9. <http://dx.doi.org/10.1002/art.11142>

161. Graudal N, Jurgens G. Similar effects of disease-modifying antirheumatic drugs, glucocorticoids, and biologic agents on radiographic progression in rheumatoid arthritis: meta-analysis of 70 randomised placebo-controlled or drug-controlled studies, including 112 comparisons. *Arthritis Rheum* 2010;**62**:2852–63. <http://dx.doi.org/10.1002/art.27592>
162. Singh JA, Beg S, Lopez-Olivo MA. Tocilizumab for rheumatoid arthritis. *Cochrane Database Syst Rev* 2010;**7**:CD008331. <http://dx.doi.org/10.1002/14651858.cd008331>
163. Singh JA, Noorbaloochi S, Singh G. Golimumab for rheumatoid arthritis. *Cochrane Database Syst Rev* 2010;**1**:CD008341. <http://dx.doi.org/10.1002/14651858.cd008341>
164. Ruiz Garcia V, Jobanputra P, Burls A, Cabello JB, Galvez Munoz JG, Saiz Cuenca ES, *et al.* Certolizumab pegol (CDP870) for rheumatoid arthritis in adults. *Cochrane Database Syst Rev* 2011;**2**:CD007649. <http://dx.doi.org/10.1002/14651858.cd007649.pub2>
165. Singh JA, Wells GA, Christensen R, Tanjong GE, Maxwell L, Macdonald JK, *et al.* Adverse effects of biologics: a network meta-analysis and Cochrane overview. *Cochrane Database Syst Rev* 2011;**2**:CD008794. <http://dx.doi.org/10.1002/14651858.cd008794.pub2>
166. Blumenauer B, Judd M, Wells G, Burls A, Cranney A, Hochberg M, *et al.* Infliximab for the treatment of rheumatoid arthritis. *Cochrane Database Syst Rev* 2002;**3**:CD003785. <http://dx.doi.org/10.1002/14651858.cd003785>
167. Navarro-Sarabia F, Ariza-Ariza R, Hernandez-Cruz B, Villanueva I. Adalimumab for treating rheumatoid arthritis. *Cochrane Database Syst Rev* 2005;**3**:CD005113. <http://dx.doi.org/10.1002/14651858.cd005113.pub2>
168. Blumenauer B, Judd M, Cranney A, Burls A, Coyle D, Hochberg M, *et al.* Etanercept for the treatment of rheumatoid arthritis. *Cochrane Database Syst Rev* 2003;**4**:CD004525. <http://dx.doi.org/10.1002/14651858.cd004525>
169. Singh JA, Christensen R, Wells GA, Suarez-Almazor ME, Buchbinder R, Lopez-Olivo MA, *et al.* Biologics for rheumatoid arthritis: an overview of Cochrane reviews. *Cochrane Database Syst Rev* 2009;**4**:CD007848. <http://dx.doi.org/10.1002/14651858.cd007848>
170. Connock M, Tubeuf S, Malotki K, Uthman A, Round J, Bayliss S, *et al.* Certolizumab pegol (CIMZIA (R)) for the treatment of rheumatoid arthritis. *Health Technol Assess* 2010;**14**(Suppl. 2). <http://dx.doi.org/10.3310/hta14suppl2/01>
171. Malotki K, Barton P, Tsourapas A, Uthman AO, Liu Z, Routh K, *et al.* Adalimumab, etanercept, infliximab, rituximab and abatacept for the treatment of rheumatoid arthritis after the failure of a tumour necrosis factor inhibitor: a systematic review and economic evaluation. *Health Technol Assess* 2011;**15**(14). <http://dx.doi.org/10.3310/hta15140>
172. Jobanputra P, Barton P, Bryan S, Burls A. The effectiveness of infliximab and etanercept for the treatment of rheumatoid arthritis: a systematic review and economic evaluation. *Health Technol Assess* 2002;**6**(21). <http://dx.doi.org/10.3310/hta6210>
173. National Institute for Health and Care Excellence. *Adalimumab, Etanercept, Infliximab, Certolizumab Pegol, Golimumab, Tocilizumab and Abatacept for the Treatment of Rheumatoid Arthritis Not Previously Treated with Disease-Modifying Anti-Rheumatic Drugs and After the Failure of Conventional Disease-Modifying Anti-Rheumatic Drugs Only*. Submission by AbbVie. 2013.
174. National Institute for Health and Care Excellence. *Adalimumab, Etanercept, Infliximab, Certolizumab, Golimumab, Abatacept, and Tocilizumab for the Treatment of Rheumatoid Arthritis (Review of TA Guidance 130, 186, 224, 234, and Part Review of TA Guidance 225 and 247) [ID537]*. Manufacturer submission of evidence: Golimumab (Simponi®). 2013.

175. Zink A, Strangfeld A, Schneider M, Herzer P, Hierse F, Stoyanova-Scholz M, *et al.* Effectiveness of tumour necrosis factor inhibitors in rheumatoid arthritis in an observational cohort study: comparison of patients according to their eligibility for major randomised clinical trials. *Arthritis Rheum* 2006;**54**:3399–407. <http://dx.doi.org/10.1002/art.22193>
176. Pincus T, Sokka T. Should contemporary rheumatoid arthritis clinical trials be more like standard patient care and vice versa? *Ann Rheum Dis* 2004;**63**:32–9. <http://dx.doi.org/10.1136/ard.2004.028415>
177. Drummond MF, Sculpher MJ, Torrance GW, O'Brien BJ, Stoddart GL. *Methods for the Economic Evaluation of Health Care Programmes*. 3rd edn. Oxford: Oxford University Press; 2005.
178. Bansback NJ, Brennan A, Ghatnekar O. Cost-effectiveness of adalimumab in the treatment of patients with moderate to severe rheumatoid arthritis in Sweden. *Ann Rheum Dis* 2005;**64**:995–1002. <http://dx.doi.org/10.1136/ard.2004.027565>
179. Barbieri M, Wong JB, Drummond M. The cost-effectiveness of infliximab for severe treatment-resistant rheumatoid arthritis in the UK. *Pharmacoeconomics* 2005;**23**:2005. <http://dx.doi.org/10.2165/00019053-200523060-00007>
180. Barton P, Jobanputra P, Wilson J, Bryan S, Burls A. The use of modelling to evaluate new drugs for patients with a chronic condition: the case of antibodies against tumour necrosis factor in rheumatoid arthritis. *Health Technol Assess* 2004;**8**(11). <http://dx.doi.org/10.3310/hta8110>
181. Benucci M, Gobbi FL, Sabadini L, Saviola G, Baiardi P, Manfredi M. The economic burden of biological therapy in rheumatoid arthritis in clinical practice: cost-effectiveness analysis of subcutaneous anti-TNF alpha treatment in Italian patients. *Int J Immunopathol Pharmacol* 2009;**22**:1147–52.
182. Brennan A, Bansback N, Reynolds A, Conway P. Modelling the cost-effectiveness of etanercept in adults with rheumatoid arthritis in the UK. *Rheumatology* 2004;**43**:62–72. <http://dx.doi.org/10.1093/rheumatology/keg451>
183. Brennan A, Bansback N, Nixon R, Madan J, Harrison M, Watson K, *et al.* Modelling the cost-effectiveness of TNF-alpha antagonists in the management of rheumatoid arthritis: results from the British Society for Rheumatology Biologics Registry. *Rheumatology* 2007;**46**:1345–54. <http://dx.doi.org/10.1093/rheumatology/kem115>
184. Chiou C-F, Choi J, Reyes CM. Cost-effectiveness analysis of biological treatments for rheumatoid arthritis. *Expert Rev Pharmacoecon Outcomes Res* 2004;**4**:307–15. <http://dx.doi.org/10.1586/14737167.4.3.307>
185. Choi HK, Seeger JD, Kuntz KM. A cost-effectiveness analysis of treatment options for methotrexate-naïve rheumatoid arthritis. *J Rheumatol* 2002;**29**:1156–65.
186. Coyle D, Judd M, Blumenauer B, Cranney A, Maetzel A, Tugwell P, *et al.* *Infliximab and Etanercept in Patients With Rheumatoid Arthritis: A Systematic Review and Economic Evaluation*. Ottawa, ON: Canadian Coordinating Office for Health Technology Assessment (CCOHTA); 2006.
187. Davies A, Cifaldi MA, Segurado OG, Weisman MH. Cost-effectiveness of sequential therapy with tumour necrosis factor antagonists in early rheumatoid arthritis. *J Rheumatol* 2009;**36**:16–26. <http://dx.doi.org/10.3899/jrheum.080257>
188. Diamantopoulos A, Benucci M, Capri S, Berger W, Wintfeld N, Giuliani G, *et al.* Economic evaluation of tocilizumab combination in the treatment of moderate-to-severe rheumatoid arthritis in Italy. *J Med Econ* 2012;**15**:576–85. <http://dx.doi.org/10.3111/13696998.2012.665110>

189. Finckh A, Bansback N, Marra CA, Anis AH, Michaud K, Lubin S, *et al.* Treatment of very early rheumatoid arthritis with symptomatic therapy, disease-modifying antirheumatic drugs, or biologic agents a cost-effectiveness analysis. *Ann Intern Med* 2009;**151**:612–21. <http://dx.doi.org/10.7326/0003-4819-151-9-200911030-00006>
190. Kobelt G, Jonsson L, Young A, Eberhardt K. The cost-effectiveness of infliximab (Remicade®) in the treatment of rheumatoid arthritis in Sweden and the United Kingdom based on the ATTRACT study. *Rheumatology* 2003;**42**:326–35. <http://dx.doi.org/10.1093/rheumatology/keg107>
191. Kobelt G, Eberhardt K, Geborek P. TNF inhibitors in the treatment of rheumatoid arthritis in clinical practice: costs and outcomes in a follow up study of patients with RA treated with etanercept or infliximab in southern Sweden. *Ann Rheum Dis* 2004;**63**:4–10. <http://dx.doi.org/10.1136/ard.2003.010629>
192. Kobelt G, Lindgren P, Singh A, Klareskog L. Cost-effectiveness of etanercept (enbrel) in combination with methotrexate in the treatment of active rheumatoid arthritis based on the TEMPO trial. *Ann Rheum Dis* 2005;**64**:1174–9. <http://dx.doi.org/10.1136/ard.2004.032789>
193. Kobelt G, Lekander I, Lang A, Raffener B, Botsios C, Geborek P. Cost-effectiveness of etanercept treatment in early active rheumatoid arthritis followed by dose adjustment. *Int J Technol Assess Health Care* 2011;**27**:193–200. <http://dx.doi.org/10.1017/S0266462311000195>
194. Lekander I, Borgstrom F, Svarvar P, Ljung T, Carli C, van Vollenhoven RF. Cost-effectiveness of real-world infliximab use in patients with rheumatoid arthritis in Sweden. *Int J Technol Assess Health Care* 2010;**26**:54–61. <http://dx.doi.org/10.1017/S0266462309990596>
195. Marra CA, Marion SA, Guh DP, Najafzadeh M, Wolfe F, Esdaile JM, *et al.* Not all 'quality-adjusted life-years' are equal. *J Clin Epidemiol* 2007;**60**:616–24. <http://dx.doi.org/10.1016/j.jclinepi.2006.09.006>
196. Nuijten MJC, Engelfriet P, Duijn K, Bruijn G, Wierz D, Koopmanschap M. A cost-cost study comparing etanercept with infliximab in rheumatoid arthritis. *Pharmacoeconomics* 2001;**19**:1051–64. <http://dx.doi.org/10.2165/00019053-200119100-00006>
197. Rubio-Terrés C, Dominguez-Gil A. Pharmacoeconomic analysis of the treatment of rheumatoid arthritis with leflunomide in comparison with the combination of infliximab and methotrexate. *J Med Econ* 2001;**4**:2001. <http://dx.doi.org/10.3111/200104019034>
198. Soini EJ, Hallinen TA, Puolakka K, Vihervaara V, Kauppi MJ. Cost-effectiveness of adalimumab, etanercept, and tocilizumab as first-line treatments for moderate-to-severe rheumatoid arthritis. *J Med Econ* 2012;**15**:340–51. <http://dx.doi.org/10.3111/13696998.2011.649327>
199. Spalding JR, Hay J. Cost-effectiveness of tumour necrosis factor-alpha inhibitors as first-line agents in rheumatoid arthritis. *Pharmacoeconomics* 2006;**24**:1221–32. <http://dx.doi.org/10.2165/00019053-200624120-00006>
200. Tanno M, Nakamura I, Ito K, Tanaka H, Ohta H, Kobayashi M, *et al.* Modelling and cost-effectiveness analysis of etanercept in adults with rheumatoid arthritis in Japan: a preliminary analysis. *Mod Rheumatol* 2006;**16**:77–84. <http://dx.doi.org/10.3109/s10165-006-0461-y>
201. van den Hout WB, Goekoop-Ruiterman YP, Allaart CF, de Vries-Bouwstra JK, Hazes JM, Kerstens PJ, *et al.* Cost-utility analysis of treatment strategies in patients with recent-onset rheumatoid arthritis. *Arthritis Rheum* 2009;**61**:291–9. <http://dx.doi.org/10.1002/art.24169>
202. Vera-Llonch M, Massarotti E, Wolfe F, Shadick N, Westhovens R, Sofrygin O, *et al.* Cost-effectiveness of abatacept in patients with moderately to severely active rheumatoid arthritis and inadequate response to methotrexate. *Rheumatology* 2008;**47**:535–41. <http://dx.doi.org/10.1093/rheumatology/ken007>

203. Wailoo AJ, Bansback N, Brennan A, Michaud K, Nixon RM, Wolfe F. Biologic drugs for rheumatoid arthritis in the Medicare program: a cost-effectiveness analysis. *Arthritis Rheum* 2008;**58**:939–46. <http://dx.doi.org/10.1002/art.23374>
204. Welsing PMJ, Severens JL, Hartman M, Van Riel PLCM, Laan RFJM. Modelling the 5-year cost-effectiveness of treatment strategies including tumour necrosis factor-blocking agents and leflunomide for treating rheumatoid arthritis in the Netherlands. *Arthritis Rheum* 2004;**51**:964–73. <http://dx.doi.org/10.1002/art.20843>
205. Wong JB, Singh G, Kavanaugh A. Estimating the cost-effectiveness of 54 weeks of infliximab for rheumatoid arthritis. *Am J Med* 2002;**113**:400–8. [http://dx.doi.org/10.1016/S0002-9343\(02\)01243-3](http://dx.doi.org/10.1016/S0002-9343(02)01243-3)
206. National Institute for Health and Care Excellence. *The Clinical Effectiveness and Cost Effectiveness of Etanercept and Infliximab for Rheumatoid Arthritis and Juvenile Poly-Articular Idiopathic Arthritis (TA36)*. 2002. URL: [www.nice.org.uk/guidance/ta36](http://www.nice.org.uk/guidance/ta36) (accessed 5 July 2013).
207. National Institute for Health and Care Excellence. *Adalimumab, Etanercept and Infliximab for the Treatment of Rheumatoid Arthritis*. URL: [www.nice.org.uk/guidance/ta130](http://www.nice.org.uk/guidance/ta130) (accessed 3 August 2013).
208. National Institute for Health and Care Excellence. *Adalimumab, Etanercept, Infliximab, Certolizumab Pegol, Golimumab, Tocilizumab and Abatacept for the Treatment of Rheumatoid Arthritis Not Previously Treated with Disease-Modifying Anti-Rheumatic Drugs and After the Failure of Conventional Disease-Modifying Anti-Rheumatic Drugs Only (Review of Technology Appraisal Guidance 130, 186, 224, 234 and a Part Review of Technology Appraisal Guidance 225 and 247)*. Bristol-Myers Squibb submission of evidence to NICE. 2013.
209. National Institute for Health and Care Excellence. *Etanercept for the Treatment of Rheumatoid Arthritis. (Review of TA Guidance 130, 186, 224, 234 and Part Review of TA Guidance 225 and 247). Multiple Technology Appraisal (MTA)*. Pfizer submission. 2013.
210. Drummond M, Jefferson T. Guidelines for authors and peer reviewers of economic submissions to the BMJ. *BMJ* 1996;**313**:275–83. <http://dx.doi.org/10.1136/bmj.313.7052.275>
211. Eddy D. Technology Assessment: The Role of Mathematical Modelling. In Mosteller F, editor. *Assessing Medical Technologies*. Washington, DC: National Academy Press; 1985. pp. 144–60.
212. Gabriel S, Drummond M, Maetzel A, Boers M, Coyle D, Welch V, *et al*. Omeract 6 economics working group report: a proposal for a reference case for economic evaluation in rheumatoid arthritis. *J Rheumatol* 2003;**30**:886–90.
213. Maetzel A, Tugwell P, Boers M, Guillemin F, Coyle D, Drummond M, *et al*. Economic evaluation of programs or interventions in the management of rheumatoid arthritis: defining a consensus-based reference case. *J Rheumatol* 2003;**30**:891–6.
214. Hyrich K, Symmons D, Watson K, Silman A, BSRBR Control Centre Consortium, British Society for Rheumatology Biologics Register. Baseline comorbidity levels in biologic and standard DMARD treated patients with rheumatoid arthritis: results from a national patient register. *Ann Rheum Dis* 2006;**65**:895–8. <http://dx.doi.org/10.1136/ard.2005.043158>
215. Burmester GR, Mariette X, Montecucco C, Monteagudo-Saez I, Malaise M, Tzioufas AG, *et al*. Adalimumab alone and in combination with disease-modifying antirheumatic drugs for the treatment of rheumatoid arthritis in clinical practice: the Research in Active Rheumatoid Arthritis (ReAct) trial. *Ann Rheum Dis* 2007;**66**:732–9. <http://dx.doi.org/10.1136/ard.2006.066761>

216. Keystone EC, Genovese MC, Klareskog L, Hsia EC, Hall ST, Miranda PC, *et al.* Golimumab, a human antibody to tumour necrosis factor (alpha) given by monthly subcutaneous injections, in active rheumatoid arthritis despite methotrexate therapy: the GO-FORWARD study. *Ann Rheum Dis* 2009;**68**:789–96. [Erratum appears in *Ann Rheum Dis* 2011;**70**:238.] <http://dx.doi.org/10.1136/ard.2008.099010>
217. Smolen JS, Nash P, Durez P, Hall S, Ilivanova E, Irazoque-Palazuelos F, *et al.* Maintenance, reduction, or withdrawal of etanercept after treatment with etanercept and methotrexate in patients with moderate rheumatoid arthritis (PRESERVE): a randomised controlled trial. *Lancet* 2013;**381**:918–29. [http://dx.doi.org/10.1016/S0140-6736\(12\)61811-X](http://dx.doi.org/10.1016/S0140-6736(12)61811-X)
218. Fleischmann R, Vencovsky J, van Vollenhoven RF, Borenstein D, Box J, Coteur G, *et al.* Efficacy and safety of certolizumab pegol monotherapy every 4 weeks in patients with rheumatoid arthritis failing previous disease-modifying antirheumatic therapy: the FAST4WARD study. *Ann Rheum Dis* 2009;**68**:805–11. <http://dx.doi.org/10.1136/ard.2008.099291>
219. *Monthly Index of Medical Specialties*. January 2013. URL: [www.mims.co.uk](http://www.mims.co.uk) (accessed 1 February 2013).
220. National Institute for Health and Care Excellence. *Guide to the Methods of Technology Appraisal 2008*. NICE Methods Guide 2008. URL: [www.nice.org.uk/media/B52/A7/TAMethodsGuideUpdatedJune2008.pdf](http://www.nice.org.uk/media/B52/A7/TAMethodsGuideUpdatedJune2008.pdf) (accessed 20 July 2013).
221. Joint Formulary Committee. *British National Formulary*. 64 ed. London: BMJ Group and Pharmaceutical Press; 2012.
222. Joint Formulary Committee. *British National Formulary* (online). URL: [www.medicinescomplete.com/mc/bnf/current/index.htm](http://www.medicinescomplete.com/mc/bnf/current/index.htm) (accessed 1 April 2013).
223. Electronic Medicines Compendium. *Tocilizumab Summary of Product Characteristics*. 2011. URL: [www.medicines.org.uk/EMC/browsedocuments.aspx](http://www.medicines.org.uk/EMC/browsedocuments.aspx) (accessed February 2013).
224. NHS. *National Schedule of Reference Costs Year: 2010–11 NHS Trusts and PCTS Combined HRG Data*. 2013. URL: <https://data.gov.uk/dataset/nhs-reference-costs-2010-11> (accessed 30 July 2013).
225. National Institute for Health and Care Excellence. *Costing Template for Infliximab for the Treatment of Adults With Psoriasis (Guidance TA134)*. 2008. URL: [www.nice.org.uk/guidance/ta134/resources](http://www.nice.org.uk/guidance/ta134/resources) (accessed 31 July 2013).
226. Bradford Teaching Hospitals NHS Trust. *Shared Care Guidelines and Monitoring Protocols for Rheumatology Patients on Disease Modifying Drugs (Including Biologic Therapies)*. Bradford: Bradford Teaching Hospitals NHS Trust & Bradford and Airedale teaching Primary Care Trust; 2010.
227. National Institute for Health and Care Excellence. *Costing Template: Tuberculosis: Clinical Diagnosis and Management of Tuberculosis and Measures for its Prevention and Control; Clinical Guideline 33*. 2013. URL: [www.nice.org.uk/guidance/cg117/resources](http://www.nice.org.uk/guidance/cg117/resources) (accessed 31 July 2013).
228. Curtis L. *Unit Costs of Health and Social Care 2011*. Canterbury: Personal Social Services Research Unit, University of Kent; 2011.
229. Chakravarty K, McDonald H, Pullar T, Taggart A, Chalmers R, Oliver S, *et al.* BSR/BHPR guideline for disease-modifying anti-rheumatic drug (DMARD) therapy in consultation with the British Association of Dermatologists. *Rheumatology* 2008;**47**:924–5. <http://dx.doi.org/10.1093/rheumatology/kei216a>
230. Department of Health. *NHS Trusts and PCTs Combined Reference Cost Schedules 2010–11*. Department of Health; 2012. URL: <https://data.gov.uk/dataset/nhs-reference-costs-2010-11/resource/91f6f5fd-c185-4bf0-8e56-718a4d769b24> (accessed 31 July 2013).

231. Roche. *Achieving Clinical Excellence in the Treatment of Moderate to Severe Rheumatoid Arthritis. RoActemra® (Tocilizumab) NICE STA Submission*. Manufacturer's submission TA198. 2009.
232. Curtis L. *Unit Costs of Health and Social Care 2012*. Canterbury: Personal Social Services Research Unit, University of Kent; 2012.
233. Curtis L. *Unit Costs of Health and Social Care 2010*. Canterbury: Personal Social Services Research Unit, University of Kent; 2010.
234. Department of Health. *NHS Reference Costs 2009–2010*. 2011. URL: [www.dh.gov.uk/en/Publicationsandstatistics/Publications/PublicationsPolicyAndGuidance/DH\\_123459](http://www.dh.gov.uk/en/Publicationsandstatistics/Publications/PublicationsPolicyAndGuidance/DH_123459) (accessed 1 April 2013).
235. Harland D, Gibbons C, Diamantopoulos A, Pang H, Huertas D, Dejonckheere F. Tocilizumab in patients where methotrexate is considered inappropriate – a cost-utility model for the UK. *Value Health* 2012;**15**:A277–575. <http://dx.doi.org/10.1016/j.jval.2012.08.1403>
236. Gabay C, Emery P, van Vollenhoven R, Dikranian A, Alten R, Klearman M, *et al*. Tocilizumab (TCZ) monotherapy is superior to adalimumab (ADA) monotherapy in reducing disease activity in patients with rheumatoid arthritis (RA): 24-week data from the phase 4 ADACTA trial. *Ann Rheum Dis* 2012;**71**:S152. <http://dx.doi.org/10.1136/annrheumdis-2012-eular.1963>
237. UCB Pharma. *Certolizumab Pegol (CIMZIA®) for the Treatment of Rheumatoid Arthritis*. Manufacturer's submission for TA186. 2009.
238. Schering-Plough Ltd. *Golimumab for the Treatment of Rheumatoid Arthritis after Failure of Previous Disease-Modifying Antirheumatic Drugs*. Manufacturer's submission to NICE. 2010.
239. Strand V, Burmester GR, Ogale S, Devenport J, John A, Emery P. Improvements in health-related quality of life after treatment with tocilizumab in patients with rheumatoid arthritis refractory to tumour necrosis factor inhibitors: results from the 24-week randomised controlled radiate study. *Rheumatology* 2012;**51**:1860–9. <http://dx.doi.org/10.1093/rheumatology/kes131>
240. Smolen JS, Kay J, Doyle MK, Landewe R, Matteson EL, Wollenhaupt J, *et al*. Golimumab in patients with active rheumatoid arthritis after treatment with tumour necrosis factor alpha inhibitors (GO-AFTER study): a multicentre, randomised, double-blind, placebo-controlled, phase III trial. *Lancet* 2009;**374**:210–21. [http://dx.doi.org/10.1016/S0140-6736\(09\)60506-7](http://dx.doi.org/10.1016/S0140-6736(09)60506-7)
241. Hurst NP, Kind P, Ruta D, Hunter M, Stubbings A. Measuring health-related quality of life in rheumatoid arthritis: validity, responsiveness and reliability of EuroQol (EQ-5D). *Rheumatology* 1997;**36**:551–9. <http://dx.doi.org/10.1093/rheumatology/36.5.551>
242. van der Heijde D, Landewe R, van Vollenhoven R, Fatenejad S, Klareskog L. Level of radiographic damage and radiographic progression are determinants of physical function: a longitudinal analysis of the TEMPO trial. *Ann Rheum Dis* 2008;**67**:1267–70. <http://dx.doi.org/10.1136/ard.2007.081331>
243. Munro R, Hampson R, McEntegart A, Thompson E, Modhok R, Capell H. Improved functional outcome in patients with early RA treated with intramuscular gold: results of a five year prospective study. *Ann Rheum Dis* 1998;**57**:88–93. <http://dx.doi.org/10.1136/ard.57.2.88>
244. Scott DL, Pugner K, Kaarela K, Doyle DV, Woolf A, Holmes J, *et al*. The links between joint damage and disability in rheumatoid arthritis. *Rheumatology* 2000;**39**:122–32. <http://dx.doi.org/10.1093/rheumatology/39.2.122>
245. Edwards CJ, Arden NK, Fisher D, Saperia JC, Reading I, van Staa TP, *et al*. The changing use of disease-modifying anti-rheumatic drugs in individuals with rheumatoid arthritis from the United Kingdom General Practice Research Database. *Rheumatology* 2005;**44**:1394–8. <http://dx.doi.org/10.1093/rheumatology/kei024>

246. Hoyle M, Henley W. Improved curve fits to summary survival data: application to economic evaluation of health technologies. *BMC Med Res Methodol* 2011;**11**:139. <http://dx.doi.org/10.1186/1471-2288-11-139>
247. Tierney J, Stewart L, Ghersi D, Burdett S, Sydes M. Practical methods for incorporating summary time-to-event data into meta-analysis. *Trials* 2007;**8**:16. <http://dx.doi.org/10.1186/1745-6215-8-16>
248. National Collaborating Centre for Chronic Conditions. *National Clinical Guideline for Rheumatoid Arthritis*. London: Royal College of Physicians; 2008.
249. Soliman MM, Ashcroft DM, Watson KD, Lunt M, Symmons DPM, Hyrich KL. Impact of concomitant use of DMARDs on the persistence with anti-TNF therapies in patients with rheumatoid arthritis: results from the British Society for Rheumatology Biologics Register. *Ann Rheum Dis* 2011;**70**:583–9. <http://dx.doi.org/10.1136/ard.2010.139774>
250. Hetland ML, Christensen IJ, Tarp U, Dreyer L, Hansen A, Hansen IT, *et al*. Direct comparison of treatment responses, remission rates, and drug adherence in patients with rheumatoid arthritis treated with adalimumab, etanercept, or infliximab: results from eight years of surveillance of clinical practice in the nationwide Danish DANBIO registry. *Arthritis Rheum* 2010;**62**:22–32. <http://dx.doi.org/10.1002/art.27227>
251. Du Pan SM, Dehler S, Ciurea A, Ziswiler HR, Gabay C, Finckh A. Comparison of drug retention rates and causes of drug discontinuation between anti-tumour necrosis factor agents in rheumatoid arthritis. *Arthritis Rheum* 2009;**61**:560–8. <http://dx.doi.org/10.1002/art.24463>
252. Keystone EC, Cohen SB, Emery P, Kremer JM, Dougados M, Loveless JE, *et al*. Multiple courses of rituximab produce sustained clinical and radiographic efficacy and safety in patients with rheumatoid arthritis and an inadequate response to 1 or more tumour necrosis factor inhibitors: 5-year data from the REFLEX Study. *J Rheumatol* 2012;**39**:2238–46. <http://dx.doi.org/10.3899/jrheum.120573>
253. Smolen JS, Kay J, Landewe RBM, Matteson EL, Gaylis N, Wollenhaupt J, *et al*. Golimumab in patients with active rheumatoid arthritis who have previous experience with tumour necrosis factor inhibitors: results of a long-term extension of the randomised, double-blind, placebo-controlled GO-AFTER study through week 160. *Ann Rheum Dis* 2012;**71**:1671–9. <http://dx.doi.org/10.1136/annrheumdis-2011-200956>
254. Emery P, Keystone E, Tony HP, Cantagrel A, van Vollenhoven R, Sanchez A, *et al*. IL-6 receptor inhibition with tocilizumab improves treatment outcomes in patients with rheumatoid arthritis refractory to anti-tumour necrosis factor biologicals: results from a 24-week multicentre randomised placebo-controlled trial. *Ann Rheum Dis* 2008;**67**:1516–23. <http://dx.doi.org/10.1136/ard.2008.092932>
255. Akaike H. A new look at the statistical model identification. *IEEE Trans Autom Control* 1974;**19**:732. <http://dx.doi.org/10.1109/TAC.1974.1100705>
256. Hjarndem E, Ostergaard M, Podenphant J, Tarp U, Andersen LS, Bing J, *et al*. Do rheumatoid arthritis patients in clinical practice benefit from switching from infliximab to a second tumour necrosis factor alpha inhibitor? *Ann Rheum Dis* 2007;**66**:1184–9. <http://dx.doi.org/10.1136/ard.2006.054742>
257. Guyot P, Ades A, Ouwens M, Welton N. Enhanced secondary analysis of survival data: reconstructing the data from published Kaplan–Meier survival curves. *BMC Med Res Methodol* 2012;**12**:9. <http://dx.doi.org/10.1186/1471-2288-12-9>
258. Trueman D, Livings C, Mildred M. PRM81 Methods of obtaining evidence from published survival data for use in decision analytic models. *Value Health* 2012;**15**:A475. <http://dx.doi.org/10.1016/j.jval.2012.08.1544>



259. Anderson J, Wells G, Verhoeven AC, Felson DT. Factors predicting response to treatment in rheumatoid arthritis: the importance of disease duration. *Arthritis Rheum* 2000;**43**:22–9. [http://dx.doi.org/10.1002/1529-0131\(200001\)43:1<22::AID-ANR4>3.0.CO;2-9](http://dx.doi.org/10.1002/1529-0131(200001)43:1<22::AID-ANR4>3.0.CO;2-9)
260. Wiles NJ, Symmons D. *Resource Use Within the Norfolk Arthritis Register (NOAR) Cohort During the First Five Years of Disease. Report for Roche*. London: NICE; 2005.
261. Department of Health. *National Schedule of Reference Costs Year: 2010–11 – NHS Trusts and PCTs Combined HRG Data*. 2013. URL: [www.gov.uk/government/publications/2010-11-reference-costs-publication](http://www.gov.uk/government/publications/2010-11-reference-costs-publication) (accessed 2 August 2013).
262. Kobelt G, Jonsson L, Lindgren P, Young A, Eberhardt K. Modelling the progression of rheumatoid arthritis: a two-country model to estimate costs and consequences of rheumatoid arthritis. *Arthritis Rheum* 2002;**46**:2310–19. <http://dx.doi.org/10.1002/art.10471>
263. Young A, Dixey J, Cox N, Davies P, Devlin J, Emery P, *et al*. How does functional disability in early rheumatoid arthritis (RA) affect patients and their lives? Results of 5 years of follow-up in 732 patients from the Early RA Study (ERAS). *Rheumatology* 2000;**39**:603–11. <http://dx.doi.org/10.1093/rheumatology/39.6.603>
264. Kobelt G, Eberhardt K, Jonsson L, Jonsson B. Economic consequences of the progression of rheumatoid arthritis in Sweden. *Arthritis Rheum* 1999;**42**:347–56. [http://dx.doi.org/10.1002/1529-0131\(199902\)42:2<347::AID-ANR18>3.0.CO;2-P](http://dx.doi.org/10.1002/1529-0131(199902)42:2<347::AID-ANR18>3.0.CO;2-P)
265. Kobelt G, Lindgren P, Lindroth Y, Jacobson L, Eberhardt K. Modelling the effect of function and disease activity on costs and quality of life in rheumatoid arthritis. *Rheumatology* 2005;**44**:1169–75. <http://dx.doi.org/10.1093/rheumatology/keh703>
266. Ducournau P, Keilhorn A, Wintfield N. *Comparison of Linear and Non-Linear Utility Mapping Between HAQ and EQ-5D Using Pooled Data from the Tolicizumab Trials OPTION and LITHE*. Poster 258; 2009.
267. Dolan P. Modelling Valuations for EuroQol Health States. *Med Care* 1997;**35**:1095–108. <http://dx.doi.org/10.1097/00005650-199711000-00002>
268. Russell AS, Conner-Spady B, Mintz A, Maksymowycz WP. The responsiveness of generic health status measures as assessed in patients with rheumatoid arthritis receiving infliximab. *J Rheumatol* 2003;**30**:941–7.
269. Wolfe F, Hawley D. Measurement of the quality of life in rheumatic disorders using the EuroQol. *Rheumatology* 1997;**36**:786–93. <http://dx.doi.org/10.1093/rheumatology/36.7.786>
270. Conner-Spady B, Suarez-Almazor ME. Variation in the estimation of quality-adjusted life-years by different preference-based instruments. *Med Care* 2003;**41**:791–801. <http://dx.doi.org/10.1097/00005650-200307000-00003>
271. Marra C, Woolcott J, Kopec J, Shojania K, Offer R, Brazier J. A comparison of generic, indirect utility measures (the HUI2, HUI3, SF-6D, and the EQ5D) and disease specific instruments (the RAQoL and the HAQ) in rheumatoid arthritis. *Soc Sci Med* 2005;**60**:1571–82. <http://dx.doi.org/10.1016/j.socscimed.2004.08.034>
272. Boggs R, Sengupta N, Ashraf T. Estimating health utility from a physical function assessment in rheumatoid arthritis (RA) patients treated with adalimumab. *Value Health* 2002;**5**:452. [http://dx.doi.org/10.1016/S1098-3015\(10\)61216-8](http://dx.doi.org/10.1016/S1098-3015(10)61216-8)
273. National Institute for Health and Care Excellence. *Guide to the Methods of Technology Appraisals*. 2008. URL: [www.nice.org.uk/media/B52/A7/TAMethodsGuideUpdatedJune2008.pdf](http://www.nice.org.uk/media/B52/A7/TAMethodsGuideUpdatedJune2008.pdf) (accessed 2 August 2013).

274. National Institute for Health and Care Excellence. *Guide to the Methods of Technology Appraisals*. 2013. URL: [www.nice.org.uk/article/pmg9/chapter/foreword](http://www.nice.org.uk/article/pmg9/chapter/foreword) (accessed 2 August 2013).
275. Bansback N, Marra C, Tsuchiya A, Anis A, Guh D, Hammond T, *et al*. Using the health assessment questionnaire to estimate preference-based single indices in patients with rheumatoid arthritis. *Arthritis Rheum* 2007;**57**:963–71. <http://dx.doi.org/10.1002/art.22885>
276. Hernandez-Alava M, Wailoo AJ, Ara R. Tails from the Peak District: adjusted limited dependent variable mixture models of EQ-5D questionnaire health state utility values. *Value Health* 2012;**15**:550–61. <http://dx.doi.org/10.1016/j.jval.2011.12.014>
277. Bansback N, Young A, Brennan A, Dixey J. A prognostic model for functional outcome in early rheumatoid arthritis. *J Rheumatol* 2006;**33**:1503–10.
278. Galloway JB, Hyrich KL, Mercer LK, Dixon WG, Fu B, Ustianowski AP, *et al*. Anti-TNF therapy is associated with an increased risk of serious infections in patients with rheumatoid arthritis especially in the first 6 months of treatment: Updated results from the British Society for Rheumatology Biologics Register with special emphasis on risks in the elderly. *Rheumatology* 2011;**50**:124–31. <http://dx.doi.org/10.1093/rheumatology/keq242>
279. Oppong R, Kaambwa B, Nuttall J, Hood K, Smith R, Coast J. The impact of using different tariffs to value EQ-5D health state descriptions: an example from a study of acute cough/lower respiratory tract infections in seven countries. *Eur J Health Econ* 2011;**14**:197–209. <http://dx.doi.org/10.1007/s10198-011-0360-9>
280. Dixon W, Symmons D, Lunt M, Watson K, Hyrich K, Silman A. Serious infection following anti-tumour necrosis factor alpha therapy in patients with rheumatoid arthritis: lessons from interpreting data from observational studies. *Arthritis Rheum* 2007;**56**:2896–904. <http://dx.doi.org/10.1002/art.22808>
281. Singh JA, Wells GA, Christensen R, Tanjong GE, Maxwell L, Macdonald JK, *et al*. Adverse effects of biologics: a network meta-analysis and Cochrane overview. *Cochrane Database Syst Rev* 2012;**2**:CD008794. <http://dx.doi.org/10.1136/annrheumdis-2012-eular.3407>
282. Wolfe F, Mitchell D, Sibley J, Fries J, Bloch D, Williams C, *et al*. The mortality of rheumatoid arthritis. *Arthritis Rheum* 1994;**37**:481–94. <http://dx.doi.org/10.1002/art.1780370408>
283. Office for National Statistics. *Interim Life Tables: 2008–2010*. URL: [www.ons.gov.uk/ons/rel/lifetables/interim-life-tables/2008-2010/index.html](http://www.ons.gov.uk/ons/rel/lifetables/interim-life-tables/2008-2010/index.html) (accessed 30 January 2013).
284. Lindgren P, Geborek P, Kobelt G. Modelling the cost-effectiveness of treatment of rheumatoid arthritis with rituximab using registry data from Southern Sweden. *Int J Technol Assess Health Care* 2009;**25**:181–9. <http://dx.doi.org/10.1017/S0266462309090230>
285. Merkesdal S, Kirchoff T, Wolka D, Ladinek G, Kielhorn A, Rubbert-Roth A. Cost-effectiveness analysis of rituximab treatment in patients in Germany with rheumatoid arthritis after etanercept-failure. *Eur J Health Econ* 2010;**11**:95–104. <http://dx.doi.org/10.1007/s10198-009-0205-y>
286. Bristol-Myers Squibb. *Abatacept for the Treatment of Rheumatoid Arthritis After the Failure of Conventional Disease-Modifying Anti-Rheumatic Drugs*. Manufacturer's submission to NICE. 2010.
287. Wu B, Wilson A, Wang FF, Wang SL, Wallace DJ, Weisman MH, *et al*. Cost-effectiveness of different treatment strategies in the treatment of patients with moderate to severe rheumatoid arthritis in China. *PLOS ONE* 2012;**7**:e47373. <http://dx.doi.org/10.1371/journal.pone.0047373>

288. Pincus T, Furer V, Keystone E, Yazici Y, Bergman MJ, Luijckens K. RAPID3 (Routine Assessment of Patient Index Data 3) severity categories and response criteria: Similar results to DAS28 (Disease Activity Score) and CDAI (Clinical Disease Activity Index) in the RAPID 1 (Rheumatoid Arthritis Prevention of Structural Damage) clinical trial of certolizumab pegol. *Arthritis Rheum* 2011;**63**:1142–9. <http://dx.doi.org/10.1002/acr.20481>
289. Yelin E, Trupin L, Wong B, Rush S. The impact of functional status and change in functional status on mortality over 18 years among persons with rheumatoid arthritis. *J Rheumatol* 2002;**29**:1851–7.
290. Office for National Statistics. *Interim Life Tables, United Kingdom, 1980–82 to 2008–10*. 2010. URL: [www.ons.gov.uk/ons/publications/re-reference-tables.html?edition=tcm%3A77-223324](http://www.ons.gov.uk/ons/publications/re-reference-tables.html?edition=tcm%3A77-223324) (accessed 1 April 2013).
291. Deighton C, Hyrich K, Ding T, Ledingham J, Lunt M, Kiely P, *et al*. BSR and BHPR rheumatoid arthritis guidelines on eligibility criteria for the first biological therapy. *Rheumatology* 2010;**49**:1197–9. <http://dx.doi.org/10.1093/rheumatology/keq006a>
292. Norton S, Sacker A, Dixey D, Done J, Williams P, Young A. Trajectories of functional limitation in early rheumatoid arthritis and their association with mortality. *Rheumatology* 2013;**52**:2016–24. <http://dx.doi.org/10.1093/rheumatology/ket253>
293. Norton S, Fu B, Verstappen S, Symmons D, Lunt M, Davies R, *et al*. *Common Trajectories of HAQ Disability Progression Over 15-years in the Early Rheumatoid Arthritis Study and the Norfolk Arthritis Register*. Poster. Berlin: EULAR; 2012.
294. Grigor C, Capell H, Stirling A, McMahon AD, Lock P, Vallance R, *et al*. Effect of a treatment strategy of tight control for rheumatoid arthritis (the TICORA study): a single-blind randomised controlled trial. *Lancet* 2004;**364**:263–9. [http://dx.doi.org/10.1016/S0140-6736\(04\)16676-2](http://dx.doi.org/10.1016/S0140-6736(04)16676-2)
295. Department of Health. *NHS Reference Costs: Financial Year 2011 to 2012*. URL: [www.gov.uk/government/publications/nhs-reference-costs-financial-year-2011-to-2012](http://www.gov.uk/government/publications/nhs-reference-costs-financial-year-2011-to-2012) (accessed 1 April 2013).
296. Bollen K, Curran P. Autoregressive latent trajectory (ALT) models. A synthesis of two traditions. *Sociol Method Res* 2004;**32**:336–83. <http://dx.doi.org/10.1177/0049124103260222>
297. Satorra A, Bentler PM. A scaled difference chi-square test statistic for moment structure analysis. *Psychometrika* 2001;**66**:507–14. <http://dx.doi.org/10.1007/BF02296192>
298. Norton S, Verstappen SMM, Symmons DP, Lunt M, Davies R, Scott DL, *et al*. Common trajectories of HAQ disability progression over 15-years in the early rheumatoid arthritis study and the Norfolk arthritis register. *Ann Rheum Dis* 2012;**71**:S508. <http://dx.doi.org/10.1136/annrheumdis-2012-eular.3060>
299. Hernandez-Alava M, Wailoo A, Wolfe F, Michaud K. A comparison of direct and indirect methods for the estimation of health utilities from clinical outcomes. *Med Decis Making* 2013;**34**:919–30. <http://dx.doi.org/10.1177/0272989X13500720>
300. Plant MJ, O'Sullivan MM, Lewis PA, Camilleri JP, Coles EC, Jessop JD. What factors influence functional ability in patients with rheumatoid arthritis. Do they alter over time? *Rheumatology* 2005;**44**:1181–5. <http://dx.doi.org/10.1093/rheumatology/keh707>
301. Symmons D, Tricker K, Roberts C, Davies L, Dawes P, Scott D. The British Rheumatoid Outcome Study Group (BROSG) randomised controlled trial to compare the effectiveness and cost-effectiveness of aggressive versus symptomatic therapy in established rheumatoid arthritis. *Health Technol Assess* 2005;**9**(34). <http://dx.doi.org/10.3310/hta9340>

302. McWilliams DF, Kiely P, Young A, Walsh D. Baseline factors predicting change from the initial DMARD treatment during the first 2 years of rheumatoid arthritis: experience in the ERAN inception cohort. *BMC Musculoskelet Disord* 2013;**14**:153. <http://dx.doi.org/10.1186/1471-2474-14-153>
303. Bansback N, Fu EHY, Sun H, Guh D, Zhang W, Lacaille D, *et al*. Impact of Biologics on Healthcare Utilisation in Patients with Rheumatoid Arthritis: An Instrumental Variable Approach. Canadian Rheumatology Meeting 2013. Poster presentation. CRA Annual Scientific Meeting and the AHPA Annual Meeting. Ottawa, Ontario, 13–16 February 2013.
304. Hernandez-Alava M, Wailoo A, Wolfe F, Michaud K. The relationship between EQ-5D, HAQ and pain in patients with rheumatoid arthritis. *Rheumatology* 2013;**52**:944–50. <http://dx.doi.org/10.1093/rheumatology/kes400>
305. Brazier JE, Yang YL, Tsuchiya A, Rowen DL. A review of studies mapping (or cross walking) non-preference based measures of health to generic preference-based measures. *Eur J Health Econ* 2010;**11**:215–25. <http://dx.doi.org/10.1007/s10198-009-0168-z>
306. Hawthorne G, Buchbinder R, Defina J. *Functional Status and Health Related Quality of Life Assessment in Patients with Rheumatoid Arthritis (Working Paper 116)*. Melbourne, VIC; Monash University Centre for Health Program Evaluation; 2000.
307. Bansback NJ, Ara R, Barkham N, Brennan A, Fraser AD, Conway P, *et al*. Estimating the cost and health status consequences of treatment with TNF antagonists in patients with psoriatic arthritis. *Rheumatology* 2006;**45**:1029–38. <http://dx.doi.org/10.1093/rheumatology/kel147>
308. Michaud K, Vera-Llonch M, Oster G. Mortality risk by functional status and health-related quality of life in patients with rheumatoid arthritis. *J Rheumatol* 2012;**39**:54–9. <http://dx.doi.org/10.3899/jrheum.110491>
309. O'Hagan A, Stevenson M, Madan J. Monte Carlo probabilistic sensitivity analysis for patient level simulation models: efficient estimation of mean and variance using ANOVA. *Health Econ* 2007;**16**:1009–23. <http://dx.doi.org/10.1002/hec.1199>
310. Heijde D, Breedveld FC, Kavanaugh A, Keystone EC, Landewé R, Patra K, *et al*. Disease activity, physical function, and radiographic progression after longterm therapy with adalimumab plus methotrexate: 5-year results of PREMIER. *J Rheumatol* 2010;**37**:2237–46. <http://dx.doi.org/10.3899/jrheum.100208>
311. Emery P, Genovese MC, van Vollenhoven R, Sharp JT, Patra K, Sasso EH. Less radiographic progression with adalimumab plus methotrexate versus methotrexate monotherapy across the spectrum of clinical response in early rheumatoid arthritis. *J Rheumatol* 2009;**36**:1429–41. <http://dx.doi.org/10.3899/jrheum.081018>
312. Haugeberg G, Conaghan PG, Quinn M, Emery P. Bone loss in patients with active early rheumatoid arthritis: infliximab and methotrexate compared with methotrexate treatment alone. Explorative analysis from a 12-month randomised, double-blind, placebo-controlled study. *Ann Rheum Dis* 2009;**68**:1898–1901. <http://dx.doi.org/10.1136/ard.2008.106484>
313. Bejarano V, Conaghan PG, Quinn MA, Saleem B, Emery P. Benefits 8 years after a remission induction regime with an infliximab and methotrexate combination in early rheumatoid arthritis. *Rheumatology* 2010;**49**:1971–4. <http://dx.doi.org/10.1093/rheumatology/keq194>
314. Fleischmann R, Weinblatt ME, Schiff MH, Khanna D, Furst D, Maldonado MA. Changes in patient reported outcomes in response to subcutaneous abatacept or adalimumab in rheumatoid arthritis: results from the ample (abatacept versus adalimumab comparison in biologic naive RA subjects with background methotrexate) trial. *Arthritis Rheum* 2012;**64**:S578.

315. Emery P, Smolen JS, Samborski W, Berenbaum F, Davies O, Ambrugeat J, *et al.* Efficacy and safety of certolizumab pegol after incomplete response to DMARDs in rheumatoid arthritis patients with low moderate disease activity: results from CERTAIN, a Phase IIIB study. *Rheumatology* 2012;**51**(Suppl. 3):Abstract 218.
316. Kameda H, Kurasawa T, Nagasawa H, Amano K, Takeuchi T. The addition of another disease-modifying anti-rheumatic drug, bucillamine, to methotrexate in place of infliximab improves the rate of infliximab-free sustained remission. *Int J Rheum Dis* 2010;**13**:107. <http://dx.doi.org/10.3109/14397595.2013.844886>
317. Hidaka T, Suzuki K, Matsuki Y, Takamizawa-Matsumoto M, Kataharada K, Ishizuka T, *et al.* Filtration leukocytapheresis therapy in rheumatoid arthritis: a randomised, double-blind, placebo-controlled trial. *Arthritis Rheum* 1999;**42**:431–7. [http://dx.doi.org/10.1002/1529-0131\(199904\)42:3<431::AID-ANR6>3.0.CO;2-2](http://dx.doi.org/10.1002/1529-0131(199904)42:3<431::AID-ANR6>3.0.CO;2-2)
318. Kremer JM, Westhovens R, Leon M, Di GE, Alten R, Steinfeld S, *et al.* Treatment of rheumatoid arthritis by selective inhibition of T-cell activation with fusion protein CTLA4Ig. *N Engl J Med* 2003;**349**:1907–15. <http://dx.doi.org/10.1056/NEJMoa035075>
319. Jobanputra P, Maggs F, Deeming A, Carruthers D, Rankin E, Jordan A, *et al.* Randomized efficacy and discontinuation study of etanercept versus adalimumab (red sea): a pragmatic, open-label, non-inferiority study of first TNF inhibitor use in rheumatoid arthritis: 1-year data. *Rheumatology* 2012;**51**(Suppl. 3):Abstract 178.
320. Genovese MC, Han C, Keystone EC, Hsia EC, Buchanan J, Gathany T, *et al.* Effect of golimumab on patient-reported outcomes in rheumatoid arthritis: results from the GO-FORWARD study. *J Rheumatol* 2012;**39**:1185–91. <http://dx.doi.org/10.3899/jrheum.111195>
321. Genovese MC, Bathon JM, Martin RW, Fleischmann RM, Tesser JR, Schiff MH, *et al.* Etanercept versus methotrexate in patients with early rheumatoid arthritis: two-year radiographic and clinical outcomes. *Arthritis Rheum* 2002;**46**:1443–50. <http://dx.doi.org/10.1002/art.10308>
322. Nishimoto N, Takagi N. Assessment of the validity of the 28-joint disease activity score using erythrocyte sedimentation rate (DAS28-ESR) as a disease activity index of rheumatoid arthritis in the efficacy evaluation of 24-week treatment with tocilizumab: subanalysis of the SATORI study. *Mod Rheumatol* 2010;**20**:539–47. <http://dx.doi.org/10.3109/s10165-010-0328-0>
323. van der Heide D. How to read radiographs according to the Sharp/van der Heijde method. *Rheumatology* 2000;**27**:261–3.
324. Maini RN, Breedveld FC, Kalden JR, Smolen JS, Furst D, Weisman MH, *et al.* Sustained improvement over two years in physical function, structural damage, and signs and symptoms among patients with rheumatoid arthritis treated with and methotrexate. *Arthritis Rheum* 2004;**50**:1051–65. <http://dx.doi.org/10.1002/art.20159>
325. Nishimoto N, Miyasaka N, Yamamoto K, Kawai S, Takeuchi T, Azuma J. Long-term safety and efficacy of tocilizumab, an anti-IL-6 receptor monoclonal antibody, in monotherapy, in patients with rheumatoid arthritis (the STREAM study): evidence of safety and efficacy in a 5-year extension study. *Ann Rheum Dis* 2009;**68**:1580–4. <http://dx.doi.org/10.1136/ard.2008.092866>



# Appendix 1 Search strategies

## Search strategies for systematic review of clinical effectiveness

### Stage 1 clinical effectiveness searches

Stage 1 searches identified trials and systematic reviews using, where appropriate, high precision search filters. Searches were undertaken in December 2012. MEDLINE and EMBASE searches were updated in May 2013. In addition to the searches detailed below, evidence was sought through hand-searching, citation and grey literature searching and through consultation of clinical trials registers. Further details are given in the main report.

#### MEDLINE(R) In-Process & Other Non-Indexed Citations and MEDLINE(R) (via Ovid)

Date range searched: 1948 to July 2013.

Search undertaken December 2012, updated May 2013.

1. exp Arthritis, Rheumatoid/
2. rheumatoid arthritis.tw
3. 1 or 2
4. randomized controlled trial.pt
5. randomized controlled trial.mp
6. 4 or 5
7. 3 and 6

#### MEDLINE(R) In-Process & Other Non-Indexed Citations and MEDLINE(R) (via Ovid)

Date range searched: 1948 to July 2013.

Search undertaken December 2012, updated May 2013.

1. exp Arthritis, Rheumatoid/
2. rheumatoid arthritis.tw
3. 1 or 2
4. medline.tw
5. systematic review.tw
6. meta analysis.pt
7. 4 or 5 or 6
8. 3 and 7

#### EMBASE (via Ovid)

Date range searched: 1980 to July 2013.

Search undertaken December 2012, updated May 2013.

1. exp rheumatoid arthritis/
2. rheumatoid arthritis.tw
3. 1 or 2
4. double blind:.mp
5. placebo:.tw
6. blind:.tw
7. 4 or 5 or 6
8. 3 and 7

**EMBASE (via Ovid)**

Date range searched: 1980 to July 2013.

Search undertaken December 2012, updated May 2013.

1. exp rheumatoid arthritis/
2. rheumatoid arthritis.tw.
3. 1 or 2
4. meta-analysis.tw.
5. systematic review.tw.
6. 4 or 5
7. 3 and 6

**Cochrane Database of Systematic Reviews (Wiley Online Library) (1996 to May 2013); Cochrane Central Register of Controlled Trials (via Wiley Online Library) (1898 to May 2013)**

Search undertaken December 2012.

"rheumatoid arthritis" OR explode Arthritis, Rheumatoid

**Cumulative Index to Nursing and Allied Health Literature (via EBSCOhost)**

Date range searched: 1982 to April 2013.

Search undertaken December 2012.

1. Explode Rheumatoid Arthritis (MH)
2. Rheumatoid arthritis (TX)
3. 1 or 2
4. Randomized (TX)
5. Treatment outcomes (MH)
6. Clinical trial (PT)
7. 4 or 5 or 6
8. 3 and 7

**Web of Science (via ISI Web of Knowledge)**

Date range searched: 1900 to present.

Search undertaken December 2012.

Rheumatoid arthritis (topic) AND (randomi?ed NEAR trial\*) (topic)

**Web of Science (via ISI Web of Knowledge)**

Date range searched: 1900 to present.

Search undertaken December 2012.

Rheumatoid arthritis (topic) AND (systematic review\* OR meta-analys?s) (topic)



## Centre for Reviews and Dissemination Database of Abstracts of Reviews of Effectiveness and Health Technology Assessment

Date range searched: 1995 to 2013.

Search undertaken December 2012.

Rheumatoid arthritis (all fields)

### *Stage 2 clinical effectiveness searches*

Stage 2 searches identified trials using high sensitivity search filters. Searches were undertaken in April 2013.

### **MEDLINE(R) In-Process & Other Non-Indexed Citations and MEDLINE(R) (via Ovid)**

Date range searched: 1948 to July 2013.

Search undertaken April 2013.

1. adalimumab.af.
2. humira.af.
3. d 2e7.af.
4. d2e7.af.
5. 331731-18-1.rn.
6. etanercept.af.
7. enbrel.af.
8. 185243-69-0.rn.
9. infliximab.af.
10. remicade.af.
11. 170277-31-3.rn.
12. ta650.af.
13. ta 650.af.
14. certolizumab pegol.af.
15. cimzia.af.
16. cdp870.af.
17. 428863-50-7.rn.
18. 1132819-27-2.rn.
19. czp.af.
20. abatacept.af.
21. orenzia.af.
22. 213252-14-3.af.
23. 332348-12-6.af.
24. bms188667.af.
25. bms 188667.af.
26. ctla4ig.af.
27. ctla 4ig.af.
28. golimumab.af.
29. cnto148.af.
30. cnto 148.af.
31. simponi.af.
32. 476181-74-5.af.
33. tocilizumab.af.
34. atlizumab.af.
35. actemra.af.
36. roactemra.af.

37. 375823-41-9.af.
38. tofacitinib.af.
39. xeljanz.af.
40. tasocitinib.af.
41. cp690550.af.
42. cp 690550.af.
43. 540737-29-9.af.
44. rituximab.af.
45. rituxan.af.
46. mabthera.af.
47. 174722-31-7.rn.
48. 1 or 2 or 3 or 4 or 5 or 6 or 7 or 8 or 9 or 10 or 11 or 12 or 13 or 14 or 15 or 16 or 17 or 18 or 19 or 20 or 21 or 22 or 23 or 24 or 25 or 26 or 27 or 28 or 29 or 30 or 31 or 32 or 33 or 34 or 35 or 36 or 37 or 38 or 39 or 40 or 41 or 42 or 43 or 44 or 45 or 46 or 47
49. rheumatoid arthritis.tw.
50. exp Arthritis, Rheumatoid/
51. 49 or 50
52. 48 and 51
53. randomized controlled trial.pt.
54. controlled clinical trial.pt.
55. randomized.ab.
56. placebo.ab.
57. drug therapy.fs.
58. randomly.ab.
59. trial.ab.
60. groups.ab.
61. 53 or 54 or 55 or 56 or 57 or 58 or 59 or 60
62. exp animals/ not humans.sh.
63. 61 not 62
64. 52 and 63

### MEDLINE(R) In-Process & Other Non-Indexed Citations and MEDLINE(R) (via Ovid)

Date range searched: 1948 to July 2013.

Search undertaken April 2013.

1. atacicept.af.
2. 845264-92-8.rn.
3. unii-k3d9a0icq3.af.
4. unii-k3d9a0icq3.af.
5. taci-fc5.af.
6. tacifc5.af.
7. taci-ig.af.
8. taciig.af.
9. 1 or 2 or 3 or 4 or 5 or 6 or 7 or 8
10. rheumatoid arthritis.tw.
11. exp Arthritis, Rheumatoid/
12. 10 or 11
13. 9 and 12
14. randomized controlled trial.pt.
15. controlled clinical trial.pt.
16. randomized.ab.
17. placebo.ab.

18. drug therapy.fs.
19. randomly.ab.
20. trial.ab.
21. groups.ab.
22. 14 or 15 or 16 or 17 or 18 or 19 or 20 or 21
23. exp animals/ not humans.sh.
24. 22 not 23
25. 13 and 24

### EMBASE (via Ovid)

Date range searched: 1980 to July 2013.

Search undertaken April 2013.

1. adalimumab.af.
2. humira.af.
3. d 2e7.af.
4. d2e7.af.
5. 331731-18-1.af.
6. etanercept.af.
7. enbrel.af.
8. 185243-69-0.af.
9. infliximab.af.
10. remicade.af.
11. 170277-31-3.af.
12. ta650.af.
13. ta 650.af.
14. certolizumab pegol.af.
15. cimzia.af.
16. cdp870.af.
17. cdp 870.af.
18. 428863-50-7.af.
19. 1132819-27-2.af.
20. czp.af.
21. abatacept.af.
22. orenzia.af.
23. 213252-14-3.af.
24. 332348-12-6.af.
25. bms188667.af.
26. bms 188667.af.
27. ctla4ig.af.
28. ctla 4ig.af.
29. golimumab.af.
30. cnto148.af.
31. cnto 148.af.
32. simponi.af.
33. 476181-74-5.af.
34. tocilizumab.af.
35. atlizumab.af.
36. actemra.af.
37. roactemra.af.
38. 375823-41-9.af.
39. tofacitinib.af.

40. xeljanz.af.
41. tasocitinib.af.
42. cp690550.af.
43. cp 690550.af.
44. 540737-29-9.af.
45. rituximab.af.
46. rituxan.af.
47. mabthera.af.
48. 174722-31-7.af.
49. 1 or 2 or 3 or 4 or 5 or 6 or 7 or 8 or 9 or 10 or 11 or 12 or 13 or 14 or 15 or 16 or 17 or 18 or 19 or 20 or 21 or 22 or 23 or 24 or 25 or 26 or 27 or 28 or 29 or 30 or 31 or 32 or 33 or 34 or 35 or 36 or 37 or 38 or 39 or 40 or 41 or 42 or 43 or 44 or 45 or 46 or 47 or 48
50. exp rheumatoid arthritis/
51. rheumatoid arthritis.tw.
52. 50 or 51
53. 49 and 52
54. random\$.tw.
55. clinical trial\$.mp.
56. exp health care quality/
57. 54 or 55 or 56
58. 53 and 57

#### EMBASE (via Ovid)

Date range searched: 1980 to July 2013.

Search undertaken April 2013.

1. atacicept.af.
2. 845264 92 8.af.
3. unii-k3d9a0icq3.af.
4. uniik3d9a0icq3.af.
5. taci-fc5.af.
6. tacifc5.af.
7. taci-ig.af.
8. taciig.af.
9. 1 or 2 or 3 or 4 or 5 or 6 or 7 or 8
10. exp rheumatoid arthritis/
11. rheumatoid arthritis.tw.
12. 10 or 11
13. 9 and 12
14. random\$.tw.
15. clinical trial\$.mp.
16. exp health care quality/
17. 14 or 15 or 16
18. 13 and 17

### Stage 3 clinical effectiveness searches

Stage 3 searches identified studies of adverse events. Searches were undertaken in July 2013. In addition to the searches detailed below evidence was sought through consultation of the National Library of Medicine (NLM) TOXLINE resource and through the website of the US Food and Drug Administration (FDA) and the European Medicines Agency (EMA).

#### MEDLINE(R) In-Process & Other Non-Indexed Citations and MEDLINE(R) (via Ovid)

Date range searched: 1948 to July 2013.

Search undertaken July 2013.

1. adalimumab.af.
2. humira.af.
3. d 2e7.af.
4. d2e7.af.
5. 331731-18-1.rn.
6. etanercept.af.
7. enbrel.af.
8. 185243-69-0.rn.
9. infliximab.af.
10. remicade.af.
11. 170277-31-3.rn.
12. ta650.af.
13. ta 650.af.
14. certolizumab pegol.af.
15. cimzia.af.
16. cdp870.af.
17. 428863-50-7.rn.
18. 1132819-27-2.rn.
19. czp.af.
20. abatacept.af.
21. orenzia.af.
22. 213252-14-3.af.
23. 332348-12-6.af.
24. bms188667.af.
25. bms 188667.af.
26. ctla4ig.af.
27. ctla 4ig.af.
28. golimumab.af.
29. cnto148.af.
30. cnto 148.af.
31. simponi.af.
32. 476181-74-5.af.
33. tocilizumab.af.
34. atlizumab.af.
35. actemra.af.
36. roactemra.af.
37. 375823-41-9.af.
38. tofacitinib.af.
39. xeljanz.af.
40. tasocitinib.af.
41. cp690550.af.
42. cp 690550.af.

43. 540737-29-9.af.
44. rituximab.af.
45. rituxan.af.
46. mabthera.af.
47. 174722-31-7.rn.
48. atacicept.af.
49. 845264-92-8.rn.
50. unii-k3d9a0icq3.af.
51. uniiik3d9a0icq3.af.
52. taci-fc5.af.
53. tacifc5.af.
54. taci-ig.af.
55. taciig.af.
56. 1 or 2 or 3 or 4 or 5 or 6 or 7 or 8 or 9 or 10 or 11 or 12 or 13 or 14 or 15 or 16 or 17 or 18 or 19 or 20 or 21 or 22 or 23 or 24 or 25 or 26 or 27 or 28 or 29 or 30 or 31 or 32 or 33 or 34 or 35 or 36 or 37 or 38 or 39 or 40 or 41 or 42 or 43 or 44 or 45 or 46 or 47 or 48 or 49 or 50 or 51 or 52 or 53 or 54 or 55
57. rheumatoid arthritis.tw.
58. exp Arthritis, Rheumatoid/
59. 57 or 58
60. 56 and 59
61. (ae or co or de).fs.
62. (safe or safety or side effect\* or undesirable effect\* or treatment emergent or tolerability or toxicity or adrs or (adverse adj2 (effect or effects or reaction or reactions or event or events or outcome or outcomes))).tw.
63. 61 or 62
64. 60 and 63

### EMBASE (via Ovid)

Date range searched: 1980 to July 2013.

Search undertaken July 2013.

1. adalimumab.af.
2. humira.af.
3. d 2e7.af.
4. d2e7.af.
5. 331731-18-1.af.
6. etanercept.af.
7. enbrel.af.
8. 185243-69-0.af.
9. infliximab.af.
10. remicade.af.
11. 170277-31-3.af.
12. ta650.af.
13. ta 650.af.
14. certolizumab pegol.af.
15. cimzia.af.
16. cdp870.af.
17. cdp 870.af.
18. 428863-50-7.af.
19. 1132819-27-2.af.
20. czp.af.

21. abatacept.af.
22. orenica.af.
23. 213252-14-3.af.
24. 332348-12-6.af.
25. bms188667.af.
26. bms 188667.af.
27. ctla4ig.af.
28. ctla 4ig.af.
29. golimumab.af.
30. cnto148.af.
31. cnto 148.af.
32. simponi.af.
33. 476181-74-5.af.
34. tocilizumab.af.
35. atlizumab.af.
36. actemra.af.
37. roactemra.af.
38. 375823-41-9.af.
39. tofacitinib.af.
40. xeljanz.af.
41. tasocitinib.af.
42. cp690550.af.
43. cp 690550.af.
44. 540737-29-9.af.
45. rituximab.af.
46. rituxan.af.
47. mabthera.af.
48. 174722-31-7.af.
49. atacicept.af.
50. 845264 92 8.af.
51. unii-k3d9a0icq3.af.
52. uniik3d9a0icq3.af.
53. taci-fc5.af.
54. tacifc5.af.
55. taci-ig.af.
56. taciig.af.
57. 1 or 2 or 3 or 4 or 5 or 6 or 7 or 8 or 9 or 10 or 11 or 12 or 13 or 14 or 15 or 16 or 17 or 18 or 19 or 20 or 21 or 22 or 23 or 24 or 25 or 26 or 27 or 28 or 29 or 30 or 31 or 32 or 33 or 34 or 35 or 36 or 37 or 38 or 39 or 40 or 41 or 42 or 43 or 44 or 45 or 46 or 47 or 48 or 49 or 50 or 51 or 52 or 53 or 54 or 55 or 56
58. exp rheumatoid arthritis/
59. rheumatoid arthritis.tw.
60. 58 or 59
61. 57 and 60
62. (safe or safety or side effect\* or undesirable effect\* or treatment emergent or tolerability or toxicity or adrs or (adverse adj2 (effect or effects or reaction or reactions or event or events or outcome or outcomes))).tw.
63. 61 and 62





## Appendix 2 Quality assessment summary of findings

TABLE 333 Quality assessment: summary of findings

Trial name/ study	Intervention	Population	NMA (Y/N)	Was the method used to generate the allocation to treatment groups adequate? (Y/N/U)	Was the allocation of treatment concealed adequately? (Y/N/U)	Were the treatment groups comparable at baseline? (Y/N/U/N/A)	Were patients and study personnel blinded to treatment? (Y/N/U)	Were participants analysed in their allocated treatment groups? (Y/N/U)	Were all randomised patients included in efficacy analyses? (Y/N/U/ mITT/N/A)	Were all randomised patients included in safety analyses? (Y/N/U/ mITT/N/A)	Were at least 80% of participants originally randomised included in the final analysis? (Y/N/U)	Free of evidence of selective reporting of outcomes? (Y/N/U)
Abe <i>et al.</i> , 2006 <sup>56</sup>	IFX	2/3	N	U	Y	Y	Y	U	mITT	mITT	Y	U
ACT-RAY <sup>57</sup>	TCZ	2/3	Y	Y	Y	Y	Y	Y	mITT	mITT	Y	N
ADACTA <sup>58</sup>	ADA, TCZ	2/3	Y	Y	Y	Y	Y	Y	mITT	mITT	Y	N
ADORE <sup>59</sup>	ETN	2/3	N	U	U	N	Y	Y	mITT	mITT	Y	U
AIM <sup>61</sup>	ABT	2/3	Y	Y	Y	Y	Y	Y	mITT	mITT	Y	Y
AMPLE <sup>66</sup>	ADA, ABT	2/3	Y	U	Y	N	Y	Y	mITT	mITT	Y	Y
APPEAL <sup>68</sup>	ETN	2/3	N	U	U	N	Y	Y	mITT	mITT	Y	N
ARMADA <sup>69</sup>	ADA	2/3	Y	U	Y	Y	Y	Y	Y	Y	Y	U
ASPIRE <sup>71</sup>	IFX	1	N	Y	Y	Y	Y	Y	N	mITT	Y	U
ASSET <sup>72</sup>	ABT	2/3	N	Y	N	Y	Y	Y	mITT	mITT	Y	N
ASSURE <sup>73</sup>	ABT	2/3	N	U	Y	Y	Y	Y	mITT	mITT	Y	N
ATTEST <sup>74</sup>	IFX, ABT	2/3	Y	U	Y	Y	Y	Y	mITT	mITT	U	N
ATTRACT <sup>75</sup>	IFX	2/3	Y	Y	N	Y	Y	Y	U	Y	Y	U
AUGUST II <sup>76</sup>	ADA	2/3	Y	Y	Y	N	Y	Y	Y	Y	Y	Y
Bejarano <i>et al.</i> , 2008 <sup>77</sup>	ADA	1	N	Y	Y	Y	Y	Y	Y	Y	Y	N
BeST <sup>78</sup>	IFX	1	Y	N	Y	N	Y	Y	U	U	Y	U

Trial name/ study	Intervention	Population	NMA (Y/N)	Was the method used to generate the allocation sequence to treatment groups adequate? (Y/N/U)	Was the allocation of treatment groups concealed adequately? (Y/N/U)	Were the treatment groups comparable at baseline? (Y/N/U/N/A)	Were patients and study personnel blinded to treatment? (Y/N/U)	Were participants analysed in their allocated treatment groups? (Y/N/U)	Were all randomised patients included in efficacy analyses? (Y/N/U/ mITT/N/A)	Were all randomised patients included in safety analyses? (Y/N/U/ mITT/N/A)	Were at least 80% of participants originally randomised included in the final analysis? (Y/N/U)	Free of evidence of selective reporting of outcomes? (Y/N/U)
CERTAIN <sup>79</sup>	CTZ	2/3	Y	U	U	U	Y	Y	U	U	Y	Y
CHANGE <sup>80</sup>	ADA	2/3	Y	U	U	Y	Y	Y	Y	Y	Y	U
COMET <sup>81</sup>	ETN	1	N	Y	Y	Y	Y	Y	mITT	mITT	Y	Y
DE019 <sup>84</sup>	ADA	2/3	Y	U	Y	Y	Y	Y	Y	Y	Y	Y
deFilippis <i>et al.</i> , 2006 <sup>85</sup>	ETN, IFX	2/3	Y	U	U	Y	N	Y	N	N	Y	U
Durez <i>et al.</i> , 2004 <sup>86</sup>	IFX	2/3	N	U	U	N	N	Y	U	U	U	U
Durez <i>et al.</i> , 2007 <sup>120</sup>	IFX	1	Y	U	U	N	U	U	U	U	Y	Y
ERA <sup>139</sup>	ETN	1	Y	U	U	Y	Y	Y	mITT	mITT	Y	U
ETN study 309 <sup>89</sup>	ETN	2/3	Y	U	U	Y	Y	Y	mITT	mITT	Y	Y
GO-BEFORE <sup>90</sup>	GOL	1	Y	Y	Y	Y	Y	Y	Y	mITT	Y	N
GO-FORTH <sup>91</sup>	GOL	2/3	Y	U	Y	Y	Y	Y	mITT	mITT	Y	Y
GO- FORWARD <sup>92</sup>	GOL	2/3	Y	Y	Y	Y	Y	Y	Y	mITT	Y	N
GUEPARD <sup>93</sup>	ADA	1	N	U	Y	N	Y	Y	mITT	Y	Y	U
HIT HARD <sup>94</sup>	ADA	1	Y	U	N	Y	Y	Y	mITT	mITT	Y	U
IDEA <sup>95</sup>	IFX	1	N	U	U	U	U	U	U	N/A	U	U
CREATE II <sup>96</sup>	ETN	2/3	Y	U	Y	Y	N	Y	Y	Y	Y	N

continued

TABLE 333 Quality assessment: summary of findings (continued)

Trial name/ study	Intervention	Population	NMA (Y/N)	Was the method used to generate the allocation sequence to treatment groups adequate? (Y/N/U)	Was the allocation of treatment adequately concealed? (Y/N/U)	Were the treatment groups comparable at baseline? (Y/N/U/N/A)	Were patients and study personnel blinded to treatment? (Y/N/U)	Were participants analysed in their allocated treatment groups? (Y/N/U)	Were all randomised patients included in efficacy analyses? (Y/N/U/ mITT/N/A)	Were all randomised patients included in safety analyses? (Y/N/U/ mITT/N/A)	Were at least 80% of participants originally included in the final analysis? (Y/N/U)	Free of evidence of selective reporting of outcomes? (Y/N/U)
JESMR <sup>140</sup>	ETN	2/3	Y	U	U	N	N	Y	mITT	mITT	Y	Y
Kay <i>et al.</i> , 2008 <sup>98</sup>	GOL	2/3	N	U	U	N	Y	Y	Y	mITT	Y	N
Kim <i>et al.</i> , 2007 <sup>99</sup>	ADA	2/3	Y	U	Y	Y	Y	Y	mITT	Y	Y	U
Kume <i>et al.</i> , 2011 <sup>100</sup>	ADA, ETN	1	N	U	Y	Y	N	Y	N	N/A	Y	N
Lan <i>et al.</i> , 2004 <sup>101</sup>	ETN	2/3	N	U	Y	Y	Y	Y	mITT	mITT	Y	U
LARA <sup>102</sup>	ETN	2/3	Y	U	Y	N	N	Y	mITT	Y	Y	U
MEASURE <sup>103</sup>	TCZ	2/3	N	U	U	Y	Y	U	U	N/A	U	U
Moreland <i>et al.</i> , 1999 <sup>104</sup>	ETN	2/3	Y	Y	Y	Y	Y	Y	mITT	mITT	Y	U
Nishimoto <i>et al.</i> , 2004 <sup>106</sup>	TCZ	2/3	N	U	Y	Y	Y	Y	Y	Y	Y	U
OPERA <sup>107</sup>	ADA	1	N	Y	Y	Y	Y	Y	mITT	mITT	Y	U
OPTIMA <sup>108</sup>	ADA	1	Y	Y	Y	Y	Y	Y	mITT	mITT	Y	Y
PREMIER <sup>109</sup>	ADA	1	Y	U	N	Y	Y	Y	mITT	mITT	Y	U
Quinn <i>et al.</i> , 2005 <sup>110</sup>	IFX	1	N	U	Y	Y	Y	Y	U	U	Y	U
RACAT <sup>111</sup>	ETN	2/3	Y	Y	Y	Y	Y	Y	N	N	Y	Y
REALISTIC <sup>113</sup>	CTZ	2/3	N	Y	Y	U	Y	Y	Y	mITT	Y	N

Trial name/ study	Intervention	Population	NMA (Y/N)	Was the method used to generate the allocation sequence to treatment groups adequate? (Y/N/U)	Was the allocation of treatment concealed adequately? (Y/N/U)	Were the treatment groups comparable at baseline? (Y/N/U/N/A)	Were patients and study personnel blinded to treatment? (Y/N/U)	Were participants analysed in their allocated treatment groups? (Y/N/U)	Were all randomised patients included in efficacy analyses? (Y/N/U/ mITT/N/A)	Were all randomised patients included in safety analyses? (Y/N/U/ mITT/N/A)	Were at least 80% of participants originally randomised included in the final analysis? (Y/N/U)	Free of evidence of selective reporting of outcomes? (Y/N/U)
RED-SEA <sup>114</sup>	ADA, ETN	2/3	N	Y	N	Y	Y	Y	mITT	mITT	Y	Y
SAMURAI <sup>115</sup>	TCZ	2/3	Y	U	Y	N	Y	Y	mITT	mITT	Y	U
SATORI <sup>116</sup>	TCZ	2/3	Y	Y	Y	Y	Y	Y	mITT	mITT	Y	N
STAR <sup>117</sup>	ADA	2/3	Y	U	Y	Y	Y	Y	mITT	mITT	Y	U
START <sup>118</sup>	IFX	2/3	Y	U	U	Y	Y	Y	mITT	N	Y	U
Swefot <sup>119</sup>	IFX	2/3	Y	Y	Y	N	Y	Y	Y	Y	Y	N
AiC information has been removed	AiC information has been removed	AiC information has been removed	AiC information has been removed	AiC information has been removed	AiC information has been removed	AiC information has been removed	AiC information has been removed	AiC information has been removed	AiC information has been removed	AiC information has been removed	AiC information has been removed	AiC information has been removed
TOWARD <sup>121</sup>	TCZ	2/3	Y	U	U	Y	Y	Y	mITT	mITT	Y	U
Van De Putte et al., 2004 <sup>122</sup>	ADA	2/3	Y	Y	Y	Y	Y	Y	Y	Y	Y	U
Wajdula 2000 (reported in Chen et al., 2006 <sup>123</sup> )	ETN	2/3	N	U	U	Y	U	U	U	U	Y	U
Weinblatt et al., 1999 <sup>124</sup>	ETN	2/3	Y	U	U	Y	Y	Y	Y	Y	Y	U

continued

TABLE 333 Quality assessment: summary of findings (continued)

Trial name/ study	Intervention	Population (Y/N)	NMA (Y/N)	Was the method used to generate the allocation treatment groups adequate? (Y/N/U)	Was the allocation of treatment concealed adequately? (Y/N/U)	Were the treatment groups comparable at baseline? (Y/N/U/N/A)	Were patients and study personnel blinded to treatment? (Y/N/U)	Were participants analysed in their allocated treatment groups? (Y/N/U)	Were all randomised patients included in efficacy analyses? (Y/N/U/ mITT/N/A)	Were all randomised patients included in safety analyses? (Y/N/U/ mITT/N/A)	Were at least 80% of participants originally included in the final analysis? (Y/N/U)	Free of evidence of selective reporting of outcomes? (Y/N/U)
Wong <i>et al.</i> , 2009 <sup>25</sup>	IFX	2/3	N	U	U	Y	Y	Y	U	N/A	U	U
Zhang <i>et al.</i> , 2006 <sup>26</sup>	IFX	2/3	N	U	U	N	Y	U	U	U	U	U

AIM, Abatacept in Inadequate responders to Methotrexate; ASPIRE, Active controlled Study of Patients receiving Infliximab for the treatment of Rheumatoid arthritis of Early onset; ASSET, Abatacept Systemic SclErosis Trial; ASSURE, Abatacept Study of Safety in Use with other RA Therapies; CHANGE, Clinical investigation in Highly disease-affected rheumatoid Arthritis patients in Japan with Adalimumab applying standard and General Evaluation study; CREATE Ib, A 6-month Randomised, Double-blind, Open Arm Comparator, Phase Ib, With AZD9056, in Patients With Rheumatoid Arthritis (RA); ERA, Early Rheumatoid Arthritis (etanercept); HIT HARD, High Induction Therapy with Anti-Rheumatic Drugs (adalimumab and methotrexate); IDEA, Remission induction comparing infliximab and high-dose intravenous steroid, followed by treat-to-target: a double-blind, randomised, controlled trial in new-onset, treatment-naïve, rheumatoid arthritis; MEASURE, secukinumab in ankylosing spondylitis; mITT, modified intention to treat; N, no; N/A, not applicable; OPTIMA, OPTimal protocol for treatment Initiation with Methotrexate and Adalimumab; REALISTIC, RA Evaluation In Subjects receiving TNF Inhibitor Certolizumab pegol; SATORI, Study of Active controlled Tocilizumab for Rheumatoid arthritis patients with an Inadequate response to methotrexate; STAR, Safety Trial of Adalimumab in Rheumatoid arthritis; U, unclear; Y, yes.

**Notes**  
 ABT i.v. = ABT ≈10 mg/kg intravenously on weeks 0, 2 and 4, and every 4 weeks thereafter.  
 ABT s.c. = ABT 125 mg once per week subcutaneously, following an optional i.v. loading dose of ≈10 mg/kg based on weight range.  
 ADA = ADA 40 mg every other week subcutaneously.  
 CTZ = s.c. CTZ 400 mg at weeks 1, 2 and 4, then 200 mg every other week.  
 ETN = ETN 25 mg twice a week subcutaneously.  
 GOL = GOL 50 mg every 4 weeks subcutaneously.  
 IFX = IFX 3 mg/kg intravenously at weeks 0, 2, 6 and every 8 weeks thereafter (with dose escalation permitted after week 12 if lack of response).  
 TCZ = TCZ 8 mg/kg intravenously every 4 weeks.

## Appendix 3 Excluded studies

**TABLE 334** Table of excluded studies with rationale for exclusion

Study	Rationale for exclusion
<p>ADJUST</p> <p>Emery P, Durez P, Dougados M, Legerton CW, Becker JC, Vratsanos G, <i>et al.</i> Impact of T-cell costimulation modulation in patients with undifferentiated inflammatory arthritis or very early rheumatoid arthritis: a clinical and imaging study of abatacept (the ADJUST trial). <i>Ann Rheum Dis</i> 2010;<b>69</b>:510–16. [Erratum published in <i>Ann Rheum Dis</i> 2011;<b>70</b>:1519]</p>	Population: DMARD naive but moderate–severe (ABT)
<p>AGREE</p> <p>Westhovens R, Robles M, Ximenes AC, Nayiager S, Wollenhaupt J, Durez P, <i>et al.</i> Clinical efficacy and safety of abatacept in methotrexate-naive patients with early rheumatoid arthritis and poor prognostic factors. <i>Ann Rheum Dis</i> 2009;<b>68</b>:1870–7</p>	Population: MTX naive (not licensed for this population) (ABT)
<p>ALLOW</p> <p>Kaine J, Gladstein G, Strusberg I, Robles M, Louw I, Gujrathi S, <i>et al.</i> Evaluation of abatacept administered subcutaneously in adults with active rheumatoid arthritis: impact of withdrawal and reintroduction on immunogenicity, efficacy and safety (Phase IIIb ALLOW study). <i>Ann Rheum Dis</i> 2012;<b>71</b>:38–44</p>	Population: prior biologics (open-label run-in phase) (ABT)
<p>ARRIVE</p> <p>Schiff M, Pritchard C, Huffstutter JE, Rodriguez-Valverde V, Durez P, Zhou X, <i>et al.</i> The 6-month safety and efficacy of abatacept in patients with rheumatoid arthritis who underwent a washout after anti-tumour necrosis factor therapy or were directly switched to abatacept: the ARRIVE trial. <i>Ann Rheum Dis</i> 2009;<b>68</b>:1708–14</p>	Population: previous use of antiTNF therapy in all (ABT)
<p>ATTAIN</p> <p>Genovese MC, Becker J-C, Schiff M, Luggen M, Sherrer Y, Kremer J, <i>et al.</i> Abatacept for rheumatoid arthritis refractory to tumour necrosis factor alpha inhibition. <i>N Engl J Med</i> 2005;<b>353</b>:1114–23</p>	Population: previous use of antiTNF therapy in all (ABT)
<p>ATTUNE</p> <p>Keystone EC, Kremer JM, Russell A, Box J, Abud-Mendoza C, Elizondo MG, <i>et al.</i> Abatacept in subjects who switch from intravenous to subcutaneous therapy: results from the phase IIIb ATTUNE study. <i>Ann Rheum Dis</i> 2012;<b>71</b>:857–61</p>	Study design: not a RCT. LTE of AIM <sup>61–65</sup> and ATTAIN trials (ABT)
<p>TAMARA</p> <p>Burmester GR, Feist E, Kellner H, Braun J, Iking-Konert C, Rubbert-Roth A. Effectiveness and safety of the interleukin 6-receptor antagonist tocilizumab after 4 and 24 weeks in patients with active rheumatoid arthritis: the first phase IIIb real-life study (TAMARA). <i>Ann Rheum Dis</i> 2011;<b>70</b>:755–9</p>	Not a RCT (single-arm study) (TCZ)
<p>ACT-SURE</p> <p>Bykerk VP, Ostor AJ, Alvaro-Gracia J, Pavelka K, Ivorra JA, Graninger W, <i>et al.</i> Tocilizumab in patients with active rheumatoid arthritis and inadequate responses to DMARDs and/or TNF inhibitors: a large, open-label study close to clinical practice. <i>Ann Rheum Dis</i> 2012;<b>71</b>:1950–4</p>	Not a RCT (TCZ)
<p>C87014</p> <p>Choy E, McKenna F, Vencovsky J, Valente R, Goel N, Vanlunen B, <i>et al.</i> Certolizumab pegol plus MTX administered every 4 weeks is effective in patients with RA who are partial responders to MTX. <i>Rheumatology</i> 2012;<b>51</b>:1226–34</p>	Intervention (not licensed dose) (CTZ)

continued

TABLE 334 Table of excluded studies with rationale for exclusion (continued)

Study	Rationale for exclusion
CanACT	Not a RCT (ADA)
Haraoui B, Cividino A, Stewart J, Guerette B, Keystone EC. Safety and effectiveness of adalimumab in a clinical setting that reflects Canadian standard of care for the treatment of rheumatoid arthritis (RA): results from the CanACT study. <i>BMC Musculoskelet Disord</i> 2011; <b>12</b> :261	
Chen HA, Lin KC, Chen CH, Liao HT, Wang HP, Chang HN, <i>et al.</i> The effect of etanercept on anti-cyclic citrullinated peptide antibodies and rheumatoid factor in patients with rheumatoid arthritis. <i>Ann Rheum Dis</i> 2006; <b>65</b> :35–9	Study investigating serum levels of anticyclic citrullinated peptide antibodies and rheumatoid factor: excluded outcomes (ETN)
Chen D-Y, Chou S-J, Hsieh T-Y, Chen Y-H, Chen H-H, Hsieh C-W, <i>et al.</i> Randomised, double-blind, placebo-controlled, comparative study of human anti-TNF antibody adalimumab in combination with methotrexate and methotrexate alone in Taiwanese patients with active rheumatoid arthritis. <i>J Formos Med Assoc</i> 2009; <b>108</b> :310–19	Participants on MTX, unclear if had inadequate response, 12-week study, <i>n</i> = 47 (ADA)
Choy EH, Hazleman B, Smith M, Moss K, Lisi L, Scott DG, <i>et al.</i> Efficacy of a novel PEGylated humanised anti-TNF fragment (CDP870) in patients with rheumatoid arthritis: a phase II double-blinded, randomised, dose-escalating trial. <i>Rheumatology</i> 2002; <b>41</b> :1133–7	Intervention: not licensed dose (CTZ)
Choy EH, Isenberg DA, Garrood T, Farrow S, Ioannou Y, Bird H, <i>et al.</i> Therapeutic benefit of blocking interleukin-6 activity with an anti-interleukin-6 receptor monoclonal antibody in rheumatoid arthritis: a randomised, double-blind, placebo-controlled, dose-escalation trial. <i>Arthritis Rheum</i> 2002; <b>46</b> :3143–50	Not in line with licensed indications
DART	Not a RCT (ADA, ETN, IFX)
Moots RJ, Haraoui B, Matucci-Cerinic M, Van Riel PLCM, Kekow J, Schaefferbeke T, <i>et al.</i> Differences in biologic dose-escalation, non-biologic and steroid intensification among three anti-TNF agents: evidence from clinical practice. <i>Clin Exp Rheumatol</i> 2011; <b>29</b> :26–34	
Doseflex	Population: prior biologics (open-label run-in) (CTZ)
Furst D, Shaikh S, Greenwald M, Bennett B, Staelens F. Evaluation of two dosing regimens of certolizumab pegol for maintenance of clinical response in patients with active rheumatoid arthritis: primary results from doseflex, a phase IIIB study. <i>Ann Rheum Dis</i> 2012; <b>71</b> :513	
Elliott MJ, Maini RN, Feldmann M, Kalden JR, Antoni C, Smolen JS, <i>et al.</i> Randomised double-blind comparison of chimeric monoclonal antibody to tumour necrosis factor alpha (cA2) versus placebo in rheumatoid arthritis. <i>Lancet</i> 1994; <b>344</b> :1105–10	Not in line with licensed indications (IFX)
RADIATE	Biologic-experienced population (outside appraisal scope) (TCZ)
Emery P, Keystone E, Tony HP, Cantagrel A, van Vollenhoven R, Sanchez A, <i>et al.</i> IL-6 receptor inhibition with tocilizumab improves treatment outcomes in patients with rheumatoid arthritis refractory to anti-tumour necrosis factor biologics: results from a 24-week multicentre randomised placebo-controlled trial. <i>Ann Rheum Dis</i> 2008; <b>67</b> :1516–23	
FAST4WARD	Intervention: not licensed dose (CTZ)
Fleischmann R, Vencovsky J, van Vollenhoven RF, Borenstein D, Box J, Coteur G, <i>et al.</i> Efficacy and safety of certolizumab pegol monotherapy every 4 weeks in patients with rheumatoid arthritis failing previous disease-modifying antirheumatic therapy: the FAST4WARD study. <i>Ann Rheum Dis</i> 2009; <b>68</b> :805–11	



TABLE 334 Table of excluded studies with rationale for exclusion (continued)

Study	Rationale for exclusion
Fleischmann R, Cutolo M, Genovese MC, Lee EB, Kanik KS, Sadis S, <i>et al.</i> Phase IIb dose-ranging study of the oral JAK inhibitor tofacitinib (CP-690,550) or adalimumab monotherapy versus placebo in patients with active rheumatoid arthritis with an inadequate response to disease-modifying antirheumatic drugs. <i>Arthritis Rheum</i> 2012; <b>64</b> :617–29	Approximately 10% of participants had prior biologics, fewer than 22 weeks of ADA treatment (10 weeks ADA then switch to TOF), so not included as additional evidence
OPPOSITE	Biologic-experienced population (outside appraisal scope) (IFX)
Furst DE, Gaylis N, Bray V, Olech E, Yocum D, Ritter J, <i>et al.</i> Open-label, pilot protocol of patients with rheumatoid arthritis who switch to infliximab after an incomplete response to etanercept: the opposite study. <i>Ann Rheum Dis</i> 2007; <b>66</b> :893–9	
Genovese MC, Sebba A, Rubbert-Roth A, Scali JJ, Alten R, Kremer JM, <i>et al.</i> Long-term safety of tocilizumab in patients with rheumatoid arthritis and a mean treatment duration of 3.7 years. <i>Arthritis Rheum</i> 2012; <b>64</b> :1640	Pooled data excluded
Genovese MC, Cohen S, Moreland L, Lium D, Robbins S, Newmark R, <i>et al.</i> Combination therapy with etanercept and anakinra in the treatment of patients with rheumatoid arthritis who have been treated unsuccessfully with methotrexate. <i>Arthritis Rheum</i> 2004; <b>50</b> :1412–19	Comparators unlicensed as ETN in combination with anakinra
Hall S, Fleischmann R. Tocilizumab inhibits radiological progression and improves physical function in rheumatoid arthritis (RA) patients at 2 years with increasing clinical efficacy over time. <i>Intern Med J</i> 2010; <b>40</b> :13	Insufficient details on data-analyses and no useable pre-withdrawal data (TCZ)
HIKARI (NCT00791921)	Study design: no separate 6-month data for those with concomitant cDMARDs and monotherapy (CTZ)
Yamamoto K, Takeuchi T, Yamanaka H, Ishiguro N, Tanaka Y, Eguchi K, <i>et al.</i> Efficacy and safety of certolizumab pegol without methotrexate co-administration in Japanese patients with active rheumatoid arthritis. Arthritis and Rheumatism Conference: Annual Scientific Meeting of the American College of Rheumatology and Association of Rheumatology Health Professionals, Chicago, IL, 4–9 November 2011	
RESTART	All patients received IFX prior to randomisation to range of IFX doses (not comparable with other trial populations at baseline) (IFX)
Ingham M, Tang L, Decktor D, Bolce R, Wang J. Benefits in patient reported outcomes supporting a 'treat to target' paradigm for infliximab-treated RA patients previously inadequately responsive to prior anti-TNF treatment. <i>Value Health</i> 2012; <b>15</b> :A42–3	
Johnsen AK, Schiff MH, Mease PJ, Moreland LW, Maier AL, Coblyn JS, <i>et al.</i> Comparison of 2 doses of etanercept (50 vs 100 mg) in active rheumatoid arthritis: a randomised double blind study. <i>J Rheumatol</i> 2006; <b>33</b> :659–64	Comparator unlicensed dose (ETN)
Kaufman J, Seel S, Roske A-E. Comparison of tocilizumab and TNF inhibitor therapy in rheumatoid arthritis. <i>Arthritis Rheum</i> 2011; <b>63</b> :S1271	Not a RCT (TCZ)
Kavanaugh A, St Clair EW, McCune WJ, Braakman T, Lipsky P. Chimeric anti-tumour necrosis factor-alpha monoclonal antibody treatment of patients with rheumatoid arthritis receiving methotrexate therapy. <i>J Rheumatol</i> 2000; <b>27</b> :841–50	Not in line with licensed indications (IFX)
Kellner H, Kellner W. Tocilizumab improves in rheumatoid arthritis patients with longstanding but still active disease the clinical disease activity (DAS28) and ameliorates MRI findings within the first three months of therapy. <i>Arthritis Rheum</i> 2011; <b>63</b> :S951	Pre-treatment with biologics (TCZ)
Keystone EC, Schiff MH, Kremer JM, Kafka S, Lovy M, DeVries T, <i>et al.</i> Once-weekly administration of 50 mg etanercept in patients with active rheumatoid arthritis: results of a multicenter, randomised, double-blind, placebo-controlled Trial. <i>Arthritis Rheum</i> 2004; <b>50</b> :353–63	Cannot distinguish results between monotherapy and combination therapy, half of participants in each of three treatment arms given MTX, half not, 8-week RCT stage of 16-week study (ETN)

continued

TABLE 334 Table of excluded studies with rationale for exclusion (continued)

Study	Rationale for exclusion
Khraishi <i>et al.</i> Long-term efficacy of tocilizumab (TCZ) in patients with rheumatoid arthritis (RA). <i>Ann Rheum Dis</i> 2011; <b>70</b> :472	Pooled data excluded (TCZ)
Kume K, Amano K, Yamada S, Hatta K. Tocilizumab improves arterial stiffness compared with abatacept in patients with TNF blockers-resistant active rheumatoid arthritis. An open label randomised controlled trial. <i>Arthritis Rheum</i> 2011; <b>63</b> :S147	All had prior biologics (TCZ)
Kume K, Amano K, Yamada S, Hatta K. Tocilizumab monotherapy improves bone mineral density as well as TNF blockers plus methotrexate with methotrexate-resistant active rheumatoid arthritis: an open-label randomised clinical trial. T-BONE trial. <i>Arthritis Rheum</i> 2011; <b>63</b> :S396	No useable scope outcome data (TCZ)
NEO-RACo	Dosing interval in induction phase not in line with licensed indications (IFX)
Leirisalo-Repo M, Kautiainen H, Laasonen L, Korpela M, Kauppi MJ, Kaipainen-Seppanen O, <i>et al.</i> Infliximab for 6 months added on combination therapy in early rheumatoid arthritis: 2-year results from an investigator-initiated, randomised, double-blind, placebo-controlled study (the NEO-RACo Study). <i>Ann Rheum Dis</i> 2013; <b>72</b> :851–7	
Lim M, Park S-H, Shim S, Baek H, Yoo D-H. A double-blind, placebo-controlled, multicenter trial of tocilizumab in moderate to severe active RA patients with inadequate response to methotrexate in Korean population. <i>Ann Rheum Dis</i> 2012; <b>71</b> :670	Insufficient description of statistical analyses in conference abstract to permit critical appraisal and handling of data (TCZ)
Lisbona MP, Maymo J, Perich J, Almirall M, Perez-Garcia C, Carbonell J. Etanercept reduces synovitis as measured by magnetic resonance imaging in patients with active rheumatoid arthritis after only 6 weeks. <i>J Rheumatol</i> 2008; <b>35</b> :394–7	Treatment of tendosynovitis in RA, mostly excluded outcomes, 6-week study (ETN)
Lisbona MP, Maymo J, Perich J, Almirall M, Carbonell J. Rapid reduction in tenosynovitis of the wrist and fingers evaluated by MRI in patients with rheumatoid arthritis after treatment with etanercept. <i>Ann Rheum Dis</i> 2010; <b>69</b> :1117–1122	
Lorenz HM, Antoni C, Valerius T, Repp R, Grunke M, Schwerdtner N, <i>et al.</i> In vivo blockade of TNF-alpha by intravenous infusion of a chimeric monoclonal TNF-alpha antibody in patients with rheumatoid arthritis. Short term cellular and molecular effects. <i>J Immunol</i> 1996; <b>156</b> :1646–53	Not in line with licensed indications (IFX)
Lorenz HM, Grunke M, Hieronymus T, Antoni C, Nusslein H, Schaible TF, <i>et al.</i> In vivo blockade of tumour necrosis factor-alpha in patients with rheumatoid arthritis: longterm effects after repeated infusion of chimeric monoclonal antibody cA2. <i>J Rheumatol</i> 2000; <b>27</b> :304–10	Not in line with licensed indications (IFX)
Maini RN, Breedveld FC, Kalden JR, Smolen JS, Davis D, Macfarlane JD, <i>et al.</i> Therapeutic efficacy of multiple intravenous infusions of anti-tumour necrosis factor monoclonal antibody combined with low-dose weekly methotrexate in rheumatoid arthritis. <i>Arthritis Rheum</i> 1998; <b>41</b> :1552–63	Not in line with licensed indications (IFX)
CHARISMA	Low levels of prior biologics and no ACR–EULAR response data at weeks 22–30 for NMA (week 16 data only) (TCZ)
Maini RN, Taylor PC, Szechinski J, Pavelka K, Broll J, Balint G, <i>et al.</i> Double-blind randomised controlled clinical trial of the interleukin-6 receptor antagonist, tocilizumab, in European patients with rheumatoid arthritis who had an incomplete response to methotrexate. <i>Arthritis Rheum</i> 2006; <b>54</b> :2817–29	
Nakashima Y, Kondo M, Harada H, Horiuchi T, Ishinishi T, Jojima H, <i>et al.</i> Clinical evaluation of tocilizumab for patients with active rheumatoid arthritis refractory to anti-TNF biologics: tocilizumab in combination with methotrexate. <i>Mod Rheumatol</i> 2010; <b>20</b> :343–52	Not a RCT (TCZ)
Marcora SM, Chester KR, Mittal G, Lemmey AB, Maddison PJ. Randomised phase 2 trial of anti-tumour necrosis factor therapy for cachexia in patients with early rheumatoid arthritis. <i>Am J Clin Nutr</i> 2006; <b>84</b> :1463–72	Treatment of cachexia (ETN)
Markatseli TE, Alamanos Y, Saougou I, Voulgari PV, Drosos AA. Survival of TNF-alpha antagonists in rheumatoid arthritis: a long-term study. <i>Clin Exp Rheumatol</i> 2012; <b>30</b> :31–8	Not a RCT (TNF inhibitors)

TABLE 334 Table of excluded studies with rationale for exclusion (continued)

Study	Rationale for exclusion
Moreland LW, Baumgartner SW, Schiff MH, Tindall EA, Fleischmann RM, Weaver AL, <i>et al.</i> Treatment of rheumatoid arthritis with a recombinant human tumour necrosis factor receptor (p75)-Fc fusion protein. <i>N Engl J Med</i> 1997; <b>337</b> :141–7	Unlicensed dose (ETN)
Nishimoto N, Ito K, Takagi N. Safety and efficacy profiles of tocilizumab monotherapy in Japanese patients with rheumatoid arthritis: meta-analysis of six initial trials and five long-term extensions. <i>Mod Rheumatol</i> 2010; <b>20</b> :222–32	Pooled data excluded
Pavelka K, Jarosova K, Suchy D, Senolt L, Chroust K, Dusek L, <i>et al.</i> Increasing the infliximab dose in rheumatoid arthritis patients: a randomised, double blind study failed to confirm its efficacy. <i>Ann Rheum Dis</i> 2009; <b>68</b> :1285–9	All patients received prior biologics (IFX)
Perkins DJ, St Clair EW, Misukonis MA, Weinberg JB. Reduction of NOS2 overexpression in rheumatoid arthritis patients treated with anti-tumour necrosis factor alpha monoclonal antibody (cA2). <i>Arthritis Rheum</i> 1998; <b>41</b> :2205–10	Not in line with licensed indications (IFX)
PRESERVE	All participants on ETN, before randomisation
Smolen JS, Nash P, Durez P, Hall S, Ilivanova E, Irazoque-Palazuelos F, <i>et al.</i> Maintenance, reduction, or withdrawal of etanercept after treatment with etanercept and methotrexate in patients with moderate rheumatoid arthritis (PRESERVE): a randomised controlled trial. <i>Lancet</i> 2013; <b>381</b> :918–29	
PRIZE	All participants on ETN, before randomisation
<i>Etanercept for the Treatment of Rheumatoid Arthritis. (Review of TA Guidance 130, 186, 224, 234 and Part Review of TA Guidance 225 and 247). Multiple Technology Appraisal (MTA). Pfizer Submission. 2013</i>	
ReACT	Not a RCT, prior biologics (ADA)
Bombardieri S, Ruiz AA, Fardellone P, Geusens P, McKenna F, Unnebrink K, <i>et al.</i> Effectiveness of adalimumab for rheumatoid arthritis in patients with a history of TNF-antagonist therapy in clinical practice. <i>Rheumatology</i> 2007; <b>46</b> :1191–99	
Roux CH, Breuil V, Valerio L, Amoretti N, Brocq O, Albert C, <i>et al.</i> Etanercept compared to intraarticular corticosteroid injection in rheumatoid arthritis: double-blind, randomised pilot study. <i>J Rheumatol</i> 2011; <b>38</b> :1009–11	Comparator steroid only (ETN)
Smeets TJ, Kraan MC, van Loon ME, Tak PP. Tumour necrosis factor alpha blockade reduces the synovial cell infiltrate early after initiation of treatment, but apparently not by induction of apoptosis in synovial tissue. <i>Arthritis Rheum</i> 2003; <b>48</b> :2155–62	No scope outcomes
GO-AFTER	Biologic-experienced population (outside appraisal scope) (GOL)
Smolen JS, Kay J, Doyle MK, Landewe R, Matteson EL, Wollenhaupt J, <i>et al.</i> Golimumab in patients with active rheumatoid arthritis after treatment with tumour necrosis factor alpha inhibitors (GO-AFTER study): a multicentre, randomised, double-blind, placebo-controlled, phase III trial. <i>Lancet</i> 2009; <b>374</b> :210–21	
STREAM	Participants did not have to have diagnosis of RA to be eligible for trial, DAS < 3.2 (ADA)
van Eijk IC, Nielen MMJ, van der Horst-Bruinsma I, Tjhuis GJ, Boers M, Dijkmans BAC, <i>et al.</i> Aggressive therapy in patients with early arthritis results in similar outcome compared with conventional care: the STREAM randomised trial. <i>Rheumatology</i> 2012; <b>51</b> :686–94	
Takeuchi T, Matsubara T, Nitobe T, Suematsu E, Ohta S, Honjo S, <i>et al.</i> Phase II dose–response study of abatacept in Japanese patients with active rheumatoid arthritis with an inadequate response to methotrexate. <i>Mod Rheumatol</i> 2013; <b>23</b> :226–35	Population: prior biologics (ABT)
RISING	All patients received IFX prior to randomisation to range of IFX doses (not comparable with other trial populations at baseline) (IFX)
Takeuchi T, Miyasaka N, Inoue K, Abe T, Koike T. Impact of trough serum level on radiographic and clinical response to infliximab plus methotrexate in patients with rheumatoid arthritis: results from the RISING study. <i>Mod Rheumatol</i> 2009; <b>19</b> :478–87	

continued

TABLE 334 Table of excluded studies with rationale for exclusion (continued)

Study	Rationale for exclusion
GO-MONO	Not in line with licensed indications (monotherapy) (GOL)
Takeuchi T, Harigai M, Tanaka Y, Yamanaka H, Ishiguro N, Yamamoto K, <i>et al.</i> Golimumab monotherapy in Japanese patients with active rheumatoid arthritis despite prior treatment with disease-modifying antirheumatic drugs: results of the phase 2/3, multicentre, randomised, double-blind, placebo-controlled GO-MONO study through 24 weeks. <i>Ann Rheum Dis</i> 2013; <b>72</b> :1488–95	
Tam LS, Shang Q, Li EK, Wang S, Li RJ, Lee KL, <i>et al.</i> Infliximab is associated with improvement in arterial stiffness in patients with early rheumatoid arthritis – a randomised trial. <i>J Rheumatol</i> 2012; <b>39</b> :2267–75	Insufficient description of cDMARD treatment history (and no ACR/EULAR data at 22–30 weeks) (IFX)
TAME	Comparator RTX
Greenwald MW, Shergy WJ, Kaine JL, Sweetser MT, Gilder K, Linnik MD. Evaluation of the safety of rituximab in combination with a tumour necrosis factor inhibitor and methotrexate in patients with active rheumatoid arthritis: results from a randomised controlled trial. <i>Arthritis Rheum</i> 2011; <b>63</b> :622–32	
Taylor PC, Steuer A, Gruber J, Cosgrove DO, Blomley MJK, Marsters PA, <i>et al.</i> Comparison of ultrasonographic assessment of synovitis and joint vascularity with radiographic evaluation in a randomised, placebo-controlled study of infliximab therapy in early rheumatoid arthritis. <i>Arthritis Rheum</i> 2004; <b>50</b> :1107–16	Not in line with licensed indications (IFX)
Van De Putte LBA, Rau R, Breedveld FC, Kalden JR, Malaise MG, Van Riel PLCM, <i>et al.</i> Efficacy and safety of the fully human anti-tumour necrosis factor alpha monoclonal antibody adalimumab (D2E7) in DMARD refractory patients with rheumatoid arthritis: a 12 week, phase II study. <i>Ann Rheum Dis</i> 2003; <b>62</b> :1168–77	Unlicensed dose (ADA)
van Vollenhoven R, Ducournau P, Wintfeld N, Berger W, Alten R. Health assessment questionnaire-disability index (HAQ-DI) scores in patients with rheumatoid arthritis (RA) treated with tocilizumab plus conventional anti-rheumatic drugs. <i>Value Health</i> 2009; <b>12</b> :A434	Pooled data excluded (TCZ)
Weinblatt ME, Schiff MH, Ruderman EM, Bingham CO III, Li J, Louie J, <i>et al.</i> Efficacy and safety of etanercept 50 mg twice a week in patients with rheumatoid arthritis who had a suboptimal response to etanercept 50 mg once a week: results of a multicenter, randomised, double-blind, active drug-controlled study. <i>Arthritis Rheum</i> 2008; <b>58</b> :1921–30	Unlicensed dose (ETN), all prior inadequate response to etanercept
ACT-STAR	High proportion of prior biologic use (outside appraisal scope) (TCZ)
Weinblatt ME, Kremer J, Cush J, Rigby W, Teng LL, Devenport J, <i>et al.</i> Tocilizumab as monotherapy or in combination with nonbiologic DMARDs: 24-week results of an open-label, clinical practice study (ACT-STAR). <i>Arthritis Care Res</i> 2013; <b>65</b> :362–71	
Westhovens R, Cole JC, Li T, Martin M, MacLean R, Lin P, <i>et al.</i> Improved health-related quality of life for rheumatoid arthritis patients treated with abatacept who have inadequate response to anti-TNF therapy in a double-blind, placebo-controlled, multicentre randomised clinical trial. <i>Rheumatology</i> 2006; <b>45</b> :1238–46	Population: inadequate response to antiTNF therapy (ABT)
Westhovens R, Houssiau F, Joly J, Everitt DE, Zhu Y, Sisco D, <i>et al.</i> A phase I study assessing the safety, clinical response, and pharmacokinetics of an experimental infliximab formulation for subcutaneous or intramuscular administration in patients with rheumatoid arthritis. <i>J Rheumatol</i> 2006; <b>33</b> :847–53	Not in line with licensed indications (IFX)
GO-FURTHER	Unlicensed dose (i.v. administration) (GOL)
Westhovens R, Weinblatt ME, Han C, Gathany T, Kim L, Mack M, <i>et al.</i> Fatigue is an independent variable predicting physical function and DAS-28 remission for patients with rheumatoid arthritis treated with intravenously administered golimumab: results from a phase 3, placebo controlled clinical trial. <i>Value Health</i> 2012; <b>15</b> :A42	

**TABLE 334** Table of excluded studies with rationale for exclusion (*continued*)

Study	Rationale for exclusion
<p>REACTION</p> <p>Yamanaka H, Tanaka Y, Inoue E, Hoshi D, Momohara S, Hanami K, <i>et al.</i> Efficacy and tolerability of tocilizumab in rheumatoid arthritis patients seen in daily clinical practice in Japan: results from a retrospective study (REACTION study). <i>Mod Rheumatol</i> 2011;<b>21</b>:122–33</p>	Not a RCT (TCZ)
<p>ROSE</p> <p>Yazici Y, Curtis JR, Ince A, Baraf H, Malamet RL, Teng LL, <i>et al.</i> Efficacy of tocilizumab in patients with moderate to severe active rheumatoid arthritis and a previous inadequate response to disease-modifying antirheumatic drugs: the ROSE study. <i>Ann Rheum Dis</i> 2012;<b>71</b>:198–205</p>	High proportion of prior biologic use (outside appraisal scope) (TCZ)
<p>ADJUST, Abatacept study to Determine the effectiveness in preventing the development of rheumatoid arthritis in patients with Undifferentiated inflammatory arthritis and to evaluate Safety and Tolerability; AGREE, Abatacept study to Gauge Remission and joint damage progression in methotrexate (MTX)-naive patients with Early Erosive rheumatoid arthritis; AIM, Abatacept in Inadequate responders to MTX; ALLOW, Evaluation of Abatacept Administered Subcutaneously in Adults With Active Rheumatoid Arthritis: Impact of Withdrawal and Reintroduction on Immunogenicity, Efficacy and Safety; ARRIVE, Abatacept Researched in RA patients with an Inadequate anti-TNF response to Validate Effectiveness; ATAIN, Abatacept Trial in Treatment of Anti-TNF Inadequate Responders; ATTUNE, Abatacept in subjects who switch from intravenous to subcutaneous therapy; CanACT, Canadian standard of care for the treatment of rheumatoid arthritis; CHARISMA, Chugai Humanized Anti-Rheumatic Interleukin Six Monoclonal Antibody; DART, Anti-TNF Drug utilization and dosing patterns Assessment: a Retrospective observational study of subjects Treated for rheumatoid arthritis; Doseflex, dosing flexibility; FAST4WARD, efficacy and Safety of certolizumab pegol – 4 Weekly dose in Rheumatoid arthritis; GO-AFTER, Golimumab After Former anti-tumour necrosis factor alpha Therapy Evaluated in Rheumatoid arthritis; OPPOSITE, Open-label, Pilot Protocol of patients with rheumatoid arthritis who Switch to Infliximab after an incomplete response to Etanercept; PRESERVE, Study Comparing Etanercept in Combination With Methotrexate in Subjects With Rheumatoid Arthritis; PRIZE, Remission Induction with Etanercept Plus Methotrexate in Early Moderate-to-Severe RA; RADIATE, Research on Actemra Determining Efficacy after Anti-TNF failures; ReACT, Research in Active Rheumatoid Arthritis; REACTION, Retrospective Actemra Investigation for Optimal Needs of RA; RISING, impact on radiographic and clinical response to infliximab therapy concomitant with methotrexate in patients with rheumatoid arthritis by trough serum level in a dose-escalating study; ROSE, Rapid Onset and Systemic Efficacy; STREAM, Strategies in Early Arthritis Management; TAMARA, Tocilizumab And DMARDs: Achievements in Rheumatoid Arthritis; TAME, Randomized, Double-Blinded, Placebo-Controlled Study to Evaluate the Tolerability and Safety of Rituximab when given in Combination with Methotrexate and Etanercept or Methotrexate and Adalimumab.</p>	



## Appendix 4 Additional data relating to the included randomised controlled trials

TABLE 335 Trial characteristics: population 1 head-to-head RCT

Trial name/ study	Trial design (RCT, phase, LTE)	Treatment arms for which data extraction performed (number of patients randomised per treatment arm)	MTX dose during study (where applicable) (mg/week)	Concomitant treatments	Duration of RCT phase	Primary outcome	Early withdrawal plan reported?	Geographical location	Funding source	Primary and supplementary publication details [author, year, publication type (e.g. full text, abstract)]
Kume <i>et al.</i> , 2011 <sup>100</sup>	RCT (open label)	ADA monotherapy (n = 22 randomised)	N/A	NR	24 weeks	Change in cardio-ankle vascular index	All patients with worsening disease activity (DAS28-ESR > 5.1 or change from baseline of DAS28-ESR > 1 at week 12 were allowed to leave the group, by clinician's judgement	Japan	NR	Kume <i>et al.</i> , 2011 <sup>100</sup> full text
Kume <i>et al.</i> , 2011 <sup>100</sup>		ETN monotherapy (n = 21 randomised)	N/A	NR						

N/A, not applicable; NR, not reported.  
ETN = ETN 25 mg twice a week subcutaneously.



TABLE 336 Trial characteristics: population 1 biologics vs. DMARD(s) or PBO

Trial name/ study	Trial design (RCT, phase, LTE)	Treatment arms for which data extraction performed (number of patients randomised per treatment arm)	MTX dose during study (where applicable)	Concomitant treatments	Duration of RCT phase	Primary outcome	Early withdrawal plan reported?	Geographical location	Funding source	Primary and supplementary publication details [author, year, publication type (e.g. full text, abstract)]
Bejarano <i>et al.</i> , 2008 <sup>77</sup>	Multicentre, RCT	PBO + MTX (n = 73)	MTX dosage increased from 7.5 mg/week to 25 mg/week by week 12 in the presence of remaining synovitis	Folate was administered according to regionally agreed Guidelines (5 mg six times/week) Stable doses of anti-inflammatory drugs, analgesics and prednisolone (up to 10 mg/day) were maintained in order for study treatment effect to be assessed without confounders. Swollen joints were permitted to be treated during the study with intra-articular injections of MP (up to 80 mg over the course of the study)	56 weeks	Job loss of any cause and/or imminent job loss at or after week 16	Rules for participant withdrawal included job loss, imminent job loss and AEs (at the discretion of the physician). Physicians could withdraw patients due to an unacceptably high disease activity	UK	Abbott Laboratories	Bejarano <i>et al.</i> , 2008 <sup>77</sup> full-text article in peer-reviewed journal
Bejarano <i>et al.</i> , 2008 <sup>77</sup>		ADA + MTX (n = 75)								

continued

TABLE 336 Trial characteristics: population 1 biologics vs. DMARD(s) or PBO (continued)

Trial name/ study	Trial design (RCT, phase, LTE)	Treatment arms for which data extraction performed (number of patients randomised per treatment arm)	MTX dose during study (where applicable)	Concomitant treatments	Duration of RCT phase	Primary outcome	Early withdrawal plan reported?	Geographical location	Funding source	Primary and supplementary publication details [author, year, publication type (e.g. full text, abstract)]
GUEPARD/ Soubrier <i>et al.</i> , 1999 <sup>93</sup>	RCT, prospective, unblinded	Initial MTX for 12 weeks, then step-up therapy in both groups based on DAS28 (n = 32)  Treatment adjusted every 3 months on the basis DAS28  If the patient did not achieve a low disease activity (DAS28 ≤ 3.2), the treating physician adjusted therapy by proceeding to the next step in the allocated treatment group	12 weeks MTX 0.3 mg/kg/week, maximum of 20 mg/week, without escalating dose regimen (then step-up)	Patients were allowed to continue concomitant treatment with corticosteroids initiated before but not after inclusion (maximum daily dose of 10 mg of oral prednisone) and to take NSAIDs and simple analgesics. A single intra-articular steroid injection was allowed during the trial. All patients received folic acid (20 mg 72 hours after MTX therapy)	1 year	The proportion of patients in low disease activity at week 12 for whom antiTNF was not introduced or reintroduced at 1 year	Step-up therapy part of intervention groups	France	Supported by a grant from the French Society of Rheumatology and the ADA treatment was provided free of charge by Abbott France	Soubrier <i>et al.</i> , 1999 <sup>93</sup> full-text article in peer-reviewed journal
		Initial monotherapy started with MTX (0.3 mg/kg/ week, maximum of 20 mg/ week, without escalating dose regimen). In the event of remission (DAS28 < 2.6 for at least 6 months), MTX was tapered (2.5 mg/month) to a maintenance dose of 7.5 mg/week. If disease activity flared after tapering of MTX, the initial dose of MTX was reintroduced. Subsequent steps for patients with an insufficient response at week 12 or thereafter were MTX and ADA (40 mg every other week), MTX and ADA (40 mg/ week), MTX and ETN (25 mg twice a week) and MTX and LEF								

Trial name/ study	Trial design (RCT, phase, LTE)	Treatment arms for which data extraction performed (number of patients randomised per treatment arm)	MTX dose during study (where applicable)	Concomitant treatments	Duration of RCT phase	Primary outcome	Early withdrawal plan reported?	Geographical location	Funding source	Primary and supplementary publication details [author, year, publication type (e.g. full text, abstract)]
GUEPARD <sup>83</sup>		Initial ADA +MTX  ADA 40 mg s.c. every other week 12 weeks, then step-up therapy in both groups based on DAS28 (n = 33)  Treatment adjusted every 3 months on the basis DAS28  If the patient did not achieve a low disease activity (DAS28 < 3.2), the treating physician adjusted therapy by proceeding to the next step in the allocated treatment group  If the DAS28 was < 3.2 at week 12, ADA was stopped. In the event of remission (DAS28 < 2.6 for at least 6 months), MTX was tapered (2.5 mg/ month) to a maintenance dose of 7.5 mg/week. If disease activity flared after tapering of MTX, the initial dose of MTX was reintroduced. In the event of relapse, patients restarted ADA 40 mg every other week for 12 weeks. If the DAS28 was > 3.2 after 12 weeks, ADA was stopped. In the event of	12 weeks MTX 0.3 mg/kg/week, maximum of 20 mg/week, without escalating dose regimen (then step-up)							

continued

TABLE 336 Trial characteristics: population 1 biologics vs. DMARD(s) or PBO (continued)

Trial name/ study	Trial design (RCT, phase, LTE)	Treatment arms for which data extraction performed (number of patients randomised per treatment arm)	MTX dose during study (where applicable)	Concomitant treatments	Duration of RCT phase	Primary outcome	Early withdrawal plan reported?	Geographical location	Funding source	Primary and supplementary publication details [author, year, publication type (e.g. full text, abstract)]
HIT HARD <sup>9A</sup>	RCT	inefficacy (DAS28 > 3.2 after 12 weeks of treatment), ADA was increased (40 mg/week) for 12 weeks. After 12 weeks of effective therapy, ADA was decreased (40 mg every other week) for 12 weeks and stopped if successful. In the event of failure on ADA 40 mg/week, ETN (25 mg twice a week) was initiated for 12 weeks. If effective, ETN was stopped and started again for 12 weeks if relapse occurred. If ETN failed, LEF was initiated. If the treatment was unsuccessful after the initial 12 weeks, the same regimen was applied according to the protocol indicated above	15 mg/week	Folic acid 10 mg/week, stable dose of ≤ 10 mg/day prednisone or equivalent permitted	24 weeks	DAS28 at week 48	No	Germany	German Federal Ministry of Education and Research (ADA provided by Abbott under unconditional scientific grant)	Detert <i>et al.</i> , 2013 <sup>9A</sup> full-text paper
HIT HARD <sup>9A</sup>		ADA + PBO (n = 87 randomised)	N/A							

Trial name/ study	Trial design (RCT, phase, LTE)	Treatment arms for which data extraction performed (number of patients randomised per treatment arm)	MTX dose during study (where applicable)	Concomitant treatments	Duration of RCT phase	Primary outcome	Early withdrawal plan reported?	Geographical location	Funding source	Primary and supplementary publication details [author, year, publication type (e.g. full text, abstract)]	
OPERA/Horslev- Petersen 2013 <sup>107</sup>	RCT	MTX + PBO + steroid (n = 91 randomised)	Dose escalated from 7.5 mg/week at baseline to 15 mg/week at 1 month and 20 mg/week after 2 months (or highest tolerated dose)	Folic acid (5–10 mg/week) and oral calcium with vitamin D (1000 mg calcium + 800 IU vitamin D daily). Alendronate (70 mg/week) initiated at baseline and mild analgesics (but not NSAIDs, muscle relaxants or other analgesics) were permitted	12 months	Proportion of patients in each group that had achieved low disease activity (DAS28-CRP <3) at 12 months	Treatment escalation – HCQ or SSZ given at 3 months if DAS28-CRP ≥ 3.2 and ≥ 1 swollen joint or 4 mg of triamcinolone had been given monthly for 3 consecutive months. If low disease activity not achieved by 6 months patient treated as a non-responder, excluded and open-label biologics (not ADA) prescribed	Denmark	Abbott Laboratories, Denmark (who also provided free ADA and PBO). Triamcinolone supplied by Meda Pharmaceuticals, Denmark	Horslev-Petersen 2013 <sup>107</sup> full-text paper	
OPERA/Horslev- Petersen 2013 <sup>107</sup>		ADA + MTX + steroid (n = 89 randomised)									
OPTIMA <sup>108</sup>	RCT (Phase IV)	MTX + PBO (n = 517 randomised)	Titrated to 20 mg/week by week 8	NSAIDs (79%), corticosteroids (46%)	26 weeks	Composite of DAS28(CRP) <3.2 at week 78 and no radiographic progression from baseline to week 78	No	North and South America, Europe, Africa, New Zealand and Australia	Abbott Laboratories	Kavanaugh <i>et al.</i> , 2013 <sup>108</sup> full-text paper  Peterfy <i>et al.</i> , 2010 <sup>150</sup> abstract  Emery <i>et al.</i> , 2011 <sup>154</sup> abstract  Smolen <i>et al.</i> , 2010 <sup>142</sup> abstract	

continued

TABLE 336 Trial characteristics: population 1 biologics vs. DMARD(s) or PBO (continued)

Trial name/ study	Trial design (RCT, phase, LTE)	Treatment arms for which data extraction performed (number of patients randomised per treatment arm)	MTX dose during study (where applicable)	Concomitant treatments	Duration of RCT phase	Primary outcome	Early withdrawal plan reported?	Geographical location	Funding source	Primary and supplementary publication details [author, year, publication type (e.g. full text, abstract)]
OPTIMA <sup>108</sup>		ADA + MTX (n = 515 randomised)		NSAIDs (78%) corticosteroids (41%)						
PREMIER <sup>109</sup>	RCT	MTX + PBO (n = 257 randomised)	7.5 mg/week for first 4 weeks, increased to 15 mg/week at weeks 4–8 if tolerated and to 20 mg/week at week 9	Folic acid, 5–10 mg/ week	2 years	ACR50 response and mean change from baseline in modified total Sharp score	Dose escalation (frequency) of ADA or PBO for those not achieving ACR20 response at week 16 or later	Australia, Europe and North America	Abbott Laboratories	Breedveld <i>et al.</i> , 2006 <sup>109</sup> full-text paper  Heijde <i>et al.</i> , 2010 <sup>310</sup> full-text paper  Emery <i>et al.</i> , 2009 <sup>311</sup> full-text paper  Strand <i>et al.</i> , 2012 <sup>155</sup> full-text paper
PREMIER <sup>109</sup>		ADA monotherapy + PBO step-up week 16 (n = 274 randomised)	N/A							
PREMIER <sup>109</sup>		ADA + MTX step-up week 16 (n = 268 randomised)	7.5 mg/week for first 4 weeks, increased to 15 mg/week at weeks 4–8 if tolerated and to 20 mg/week at week 9							

Trial name/ study	Trial design (RCT, phase, LTE)	Treatment arms for which data extraction performed (number of patients randomised per treatment arm)	MTX dose during study (where applicable)	Concomitant treatments	Duration of RCT phase	Primary outcome	Early withdrawal plan reported?	Geographical location	Funding source	Primary and supplementary publication details [author, year, publication type (e.g. full text, abstract)]
COMET <sup>91-83</sup> Emery <i>et al.</i> , 2010, <sup>82</sup> Kekow <i>et al.</i> , 2010 <sup>83</sup> (NCT00195494)	Prospective double-blind multicentre RCT	MTX + PBO ( <i>n</i> = 268) First period comprised two randomised groups: (a) MTX monotherapy in year 1 followed by combination (ETN + MTX) treatment in year 2 ( <i>n</i> = 90 at start of period 2) (b) MTX monotherapy in year 1 followed by continued MTX monotherapy in year 2 ( <i>n</i> = 99 at start of period 2)	Starting at 7.5 mg once a week. In patients with tender or swollen joints, the dose was titrated up over 8 weeks to a maximum of 20 mg a week	Stable doses of oral corticosteroids ( $\leq$ 10 mg per day of prednisone or an equivalent agent) or a single NSAID were permitted if started at least 4 weeks before baseline and kept constant throughout the study	52 weeks	Copriary end points were the proportion of patients achieving remission (DAS28 < 2.6) at week 52 and the change in van der Heijde modified total Sharp score (modified total Sharp score; joint erosion score plus JSN score) from baseline to week 52	NR	Europe, Latin America, Asia and Australia	Wyeth Research	Emery <i>et al.</i> 2008 <sup>81</sup> full-text article in peer-reviewed journal
COMET <sup>91-83</sup>		ETN + MTX ( <i>n</i> = 274) First period comprised two randomised groups: (a) combination ETM + MTX treatment in year 1 followed by continued combination treatment in year 2 ( <i>n</i> = 111 at start of period 2) (b) combination treatment in year 1 followed by ETN alone in year 2 ( <i>n</i> = 111 at start of period 2)	Starting at 7.5 mg once a week. In patients with tender or swollen joints, the dose was titrated up over 8 weeks to a maximum of 20 mg a week							

continued

TABLE 336 Trial characteristics: population 1 biologics vs. DMARD(s) or PBO (continued)

Trial name/ study	Trial design (RCT, phase, LTE)	Treatment arms for which data extraction performed (number of patients randomised per treatment arm)	MTX dose during study (where applicable)	Concomitant treatments	Duration of RCT phase	Primary outcome	Early withdrawal plan reported?	Geographical location	Funding source	Primary and supplementary publication details [author, year, publication type (e.g. full text, abstract)]
ERA <sup>139</sup>	RCT	MTX + PBO (n = 217 randomised)	Initial dose of 7.5 mg/week escalated to 15 mg/week at week 4 and 20 mg/week at week 8. One 5-mg reduction permitted	Folic acid (1 mg/day)	12 months	Overall response during the first 6 months	No	NR	Immunex	Bathon <i>et al.</i> , 2000 <sup>87</sup> full-text paper
ERA/Bathon and Genovese, 2003 <sup>139</sup> multicentre		ETN + PBO (n = 207 randomised)								Bathon and Genovese, 2003 <sup>139</sup> full-text paper
GO-BEFORE <sup>90</sup> (EudraCT database no. 2004-003295-10)	RCT (Phase III, double blind)	PBO + MTX (n = 160)	19.1 mg/week (SD = 2.7 mg/ week) (week 23)	NSAIDs, other analgesics for RA and oral corticosteroids (≤ 10 mg of prednisone/ day or equivalent) permitted if doses stable for ≥ 2 weeks before initiation of study agent and during treatment	52 weeks	Co-primary end points: ACR50 response at week 24	No	Multicentre, multinational (90 sites across Europe/ Australia/New Zealand (n = 34), Asia (n = 25), North American (n = 2) and Latin America (n = 10))	Centocor Research and Development and Schering- Plough Research Institute)	Emery <i>et al.</i> , 2009 <sup>90</sup> full publication
GO-BEFORE <sup>90</sup>		GOL 50 mg s.c. every 4 weeks + MTX (n = 159)	19.2 mg/week (SD = 2.35 mg/ week) (week 23)			Change from baseline in modified Sharp/van der Heijde score at week 52				



Trial name/ study	Trial design (RCT, phase, LTE)	Treatment arms for which data extraction performed (number of patients randomised per treatment arm)	MTX dose during study (where applicable)	Concomitant treatments	Duration of RCT phase	Primary outcome	Early withdrawal plan reported?	Geographical location	Funding source	Primary and supplementary publication details [author, year, publication type (e.g. full text, abstract)]
ASPIRE <sup>71</sup>	RCT (Phase III, double blind)	PBO+ MTX (n = 298 randomised)	MTX started at 7.5 mg/week and increased (2.5 mg/week every 1–2 weeks) to 15 mg/week by week 4 and 20 mg/week by week 8. MTX dose could be adjusted in case of intolerance	Oral corticosteroids (≤ 10 mg/day of prednisone or equivalent) and NSAIDs maintained at baseline doses. Other DMARDs not allowed during study	54 weeks	For radiographic progression of joint damage: change from baseline to week 54 in van der Heijde modification of total Sharp score  For physical function: change from baseline in HAQ scores averaged over weeks 30–54	No	Multicentre, multinational (122 sites in North America and Europe)	Centocor	St Clair <i>et al.</i> 2004, <sup>71</sup> full publication
ASPIRE <sup>71</sup>		IFX i.v. 3 mg/kg at weeks 0, 2 and 6 and every 8 weeks thereafter + MTX (n = 373 randomised)								
BeST <sup>78</sup>	RCT (phase NR, open label)	Sequential monotherapy (n = 126 randomised)	DAS-steered step-up strategies for all four treatment groups	Concomitant treatment with NSAIDs and intra-articular injections with corticosteroids permitted	3 years	HAQ and modified Sharp/van der Heijde score	No (DAS-steered step-up strategies for all four treatment groups)	Multicentre, the Netherlands	Dutch College of Health Insurances; Schering- Plough	Goekoop- Ruiterman <i>et al.</i> 2008 <sup>78</sup> full publication
BeST <sup>78</sup>		Step-up combination therapy (n = 121 randomised)								
BeST <sup>78</sup>		Initial combination therapy with prednisone (n = 133 randomised)								
BeST <sup>78</sup>		Initial combination therapy with IFX (n = 128 randomised)								

continued

TABLE 336 Trial characteristics: population 1 biologics vs. DMARD(s) or PBO (continued)

Trial name/ study	Trial design (RCT, phase, LTE)	Treatment arms for which data extraction performed (number of patients randomised per treatment arm)	MTX dose during study (where applicable)	Concomitant treatments	Duration of RCT phase	Primary outcome	Early withdrawal plan reported?	Geographical location	Funding source	Primary and supplementary publication details [author, year, publication type (e.g. full text, abstract)]
Durez <i>et al.</i> , 2007 <sup>120</sup> (NCT00396747)	RCT (Phase IV, single blind)	MTX (n = 14 randomised)	All patients received MTX at dosage ranging from 7.5 mg/ week (baseline) to 20 mg/week (week 14)	Patients receiving NSAIDs required to be receiving stable doses (remaining unchanged during study), i.e. steroids not permitted. Introduction of oral glucocorticosteroids of other DMARDs not permitted	12 months	Evaluation of magnetic resonance imaging scores over time	No	Belgium	Schering- Plough	Durez <i>et al.</i> , 2007 <sup>120</sup> full publication
Durez <i>et al.</i> , 2007 <sup>120</sup>		MTX + i.v. methylprednisolone 1 g at weeks 0, 2 and 6 and then every 8 weeks thereafter (n = 15 randomised)								
Durez <i>et al.</i> , 2007 <sup>120</sup>		IFX 3 mg/kg i.v. at weeks 0, 2, 6, 14, 22, 30, 38 and 46 + MTX (n = 15 randomised)								
IDEA <sup>95</sup>	RCT (phase NR, double blind to week 26)	Methylprednisolone 250 mg i.v. at week 0, PBO i.v. at weeks 2, 6, 14 and 22 + MTX  Numbers randomised NR (n = 112 patients included across both groups)	IFX 3 mg/kg at weeks 0, 2, 6, 14, 22 + MTX 10 mg weekly increasing to 20 mg by week 6 with IFX dose modification depending on DAS44 from week 26		78 weeks	NR	Step-up from week 26 if DAS > 2.4. Other biologics permitted from week 26 (no further details) (data extracted to week 26)	Multicentre (no further details)	NR	Nam <i>et al.</i> , 2011 <sup>95</sup> conference abstract

Trial name/ study	Trial design (RCT, phase, LTE)	Treatment arms for which data extraction performed (number of patients randomised per treatment arm)	MTX dose during study (where applicable)	Concomitant treatments	Duration of RCT phase	Primary outcome	Early withdrawal plan reported?	Geographical location	Funding source	Primary and supplementary publication details [author, year, publication type (e.g. full text, abstract)]
IDEA <sup>95</sup>		IFX 3 mg/kg i.v. at weeks 0, 2, 6, 14 and 22 + MTX (IFX dose modifications permitted according to DAS44 from week 26)								
		Numbers randomised NR (n = 112 patients included across both groups)								
Quinn <i>et al.</i> , 2005 <sup>110</sup>	RCT	MTX + PBO (n = 10 randomised)	7.5 mg/week with escalation up to 15 mg/ week by week 14. Increments up to 25 mg/ week titrated against evidence of active disease	Folic acid 5 mg twice a week	54 weeks	Comparison of magnetic resonance imaging- measured synovitis at week 14 between groups	No	NR	Arthritis Research Campaign	Quinn <i>et al.</i> , 2005 <sup>110</sup> full-text paper  Haugeberg <i>et al.</i> , 2009 <sup>312</sup> full-text paper  Bejarano <i>et al.</i> , 2010, <sup>313</sup> full-text paper 2008 <sup>77</sup>
Quinn <i>et al.</i> , 2005 <sup>110</sup>		IFX 3 mg/kg + MTX (n = 10 randomised)								
<p>ASPIRE, Active controlled Study of Patients receiving Infliximab for the treatment of Rheumatoid arthritis of Early onset; DAS44, Disease Activity Score 44 joints; ERA, Early Rheumatoid Arthritis (etanercept); EudraCT, European Union Drug Regulating Authorities Clinical Trials; HIT HARD, High Induction Therapy with Anti-Rheumatic Drugs (adalimumab and methotrexate); IDEA, Remission induction comparing infliximab and high-dose intravenous steroid, followed by treat-to-target: a double-blind, randomised, controlled trial in new-onset, treatment-naïve, rheumatoid arthritis; JSN, joint space narrowing; N/A, not applicable; NCT, clinicaltrials.gov reference number; NR, not reported; OPTIMA, OPTimal protocol for treatment initiation with Methotrexate and Adalimumab.            ADA = ADA 40 mg every other week subcutaneously.            ETN = ETN 25 mg twice a week subcutaneously.            TCZ = TCZ 8 mg/kg intravenously every 4 weeks.</p>										

TABLE 337 Trial characteristics: populations 2 and 3 head-to-head RCTs

Trial name/study (NCT/sponsor number)	Trial design (RCT, phase, LTE)	Treatment arms for which data extraction performed (number of patients randomised per treatment arm)	MTX dose during study (where applicable)	Concomitant treatments	Duration of RCT phase	Primary outcome	Early withdrawal plan reported?	Geographical location	Funding source	Primary and supplementary publication details (author, year, publication type (e.g. full, abstract))
ATTEST <sup>74</sup> (NCT00095147)	RCT (Phase III, double blind)	PBO + MTX (with blinded crossover to ABT at day 198) (n = 110 randomised)	No MTX dose adjustments permitted except due to AEs  MTX dose could be altered (to <25 mg/week) between days 198–365	Permitted days 1–197: oral corticosteroids (≤ 10 mg/day of prednisone or equivalent) (stable ≥ 25/28 days prior to randomisation), and/or stable NSAIDs and analgesics. Days 198–365 dose of oral corticosteroids could be modified (≤ 10 mg/day of prednisone or equivalent), HCQ, SSZ, GLD or AZA also permitted	PBO-controlled phase to day 197	DAS28-ESR ABT vs. PBO at 6 months (not powered with superiority or non-inferiority design to compare two active arms)	No	Multinational, multicentre (86 sites)	Bristol-Myers Squibb, USA	Schiff <i>et al.</i> , 2008 <sup>74</sup> full publication
ATTEST <sup>74</sup>		IFX 3 mg/kg i.v. administered on days 1 (i.e. week 0), 15 (i.e. week 2), 43 (i.e. week 6) and 85 (i.e. week 12) and every 56 days (i.e. 8 weeks) thereafter (NB: licensed dose 3 mg/kg i.v. at weeks 0, 2, 6 and every 8 weeks thereafter, adjustments in dosage and frequency of administration permitted after week 12 in license) + MTX (n = 165 randomised)								

Trial name/study (NCT/sponsor number)	Trial design (RCT, phase, LTE)	Treatment arms for which data extraction performed (number of patients randomised per treatment arm)	MTX dose during study (where applicable)	Concomitant treatments	Duration of RCT phase	Primary outcome	Early withdrawal plan reported?	Geographical location	Funding source	Primary and supplementary publication details (author, year, publication type (e.g. full, abstract))
ATTEST <sup>74</sup>		ABT dosed according to weight: patients weighing <60 kg, 60–100 kg or > 100 kg received 500 mg, 750 mg or 1000 mg of ABT respectively. ABT administered i.v. on days 1, 15 and 29 and every 28 days thereafter, up to and including day 337 + MTX (n = 156 randomised)								
AMPLE <sup>66</sup>	RCT (non-inferiority)	ABT s.c. + MTX (n = 318)	15–25 mg/week (or ≥ 7.5 mg/week in patients intolerant to higher doses)	Prednisone (mean dose 6.6 mg/day) Corticosteroids (50.9%) SFZ (3.1%) HCQ (13.2%)	2 years (first 12 months' data just published)	ACR20 response at 1 year	No	North and South America	Bristol-Myers Squibb	Weinblatt <i>et al.</i> , 2013 <sup>144</sup> full-text paper Fleischmann <i>et al.</i> , 2012 <sup>14</sup>
AMPLE <sup>144</sup>		ADA + MTX (n = 328)	15–25 mg/week (or ≥ 7.5 mg/week in patients intolerant to higher doses) 17.3 (6.16) mg/week at baseline	Prednisone (mean dose 6.4 mg/day) Corticosteroids (50.3%) SFZ (3.4%) HCQ (10.7%)						

continued



Trial name/study (NCT/sponsor number)	Trial design (RCT, phase, LTE)	Treatment arms for which data extraction performed (number of patients randomised per treatment arm)	MTX dose during study (where applicable)	Concomitant treatments	Duration of RCT phase	Primary outcome	Early withdrawal plan reported?	Geographical location	Funding source	Primary and supplementary publication details [author, year, publication type (e.g. full, abstract)]
ADACTA <sup>58</sup> (NCT0119859)	RCT (Phase IV, double blind)	TCZ 8 mg/kg i.v. every 4 weeks + s.c. PBO ADA (n = 163 randomised)	N/A	All DMARDs washed out before baseline (all ≥ 2 weeks, LEF ≥ 12 weeks or after standard washout)	24 weeks	Mean change from baseline in DAS28 at 24 weeks	Yes	Multicentre, multinational	Roche	Gabay <i>et al.</i> , 2013 <sup>58</sup> full publication
ADACTA <sup>58</sup>		ADA + PBO (n = 163 randomised)	N/A							
deFillippis <i>et al.</i> , 2006 <sup>35</sup>	RCT	ETN + MTX (n = 16)	Between 10 mg/week and 12.5 mg/week	Prednisone (maximum dosage 10 mg/day)	54 weeks	ACR20, ACR50, ACR70 and HAQ improvement	No	Sicily	NR	deFillippis <i>et al.</i> , 2006 <sup>35</sup> full-text paper
deFillippis <i>et al.</i> , 2006 <sup>35</sup>		IFX + MTX (n = 16)	Between 10 mg/week and 12.5 mg/week							

ETN50, etanercept 50 mg once a week subcutaneous; N/A, not applicable; NCT, clinicaltrials.gov reference number; NR, not reported.  
 ABT i.v. = BT ≈10 mg/kg intravenously on weeks 0, 2 and 4, and every 4 weeks thereafter.  
 ABT s.c. = ABT 125 mg once per week subcutaneous, following an optional i.v. loading dose of ≈10 mg/kg based on weight range.  
 ADA = ADA 40 mg every other week subcutaneous.  
 ETN = ETN 25 mg twice a week subcutaneous.  
 IFX = IFX 3 mg/kg intravenously at weeks 0, 2, 6 and every 8 weeks thereafter (with dose escalation permitted after week 12 if lack of response).  
 TCZ = TCZ 8 mg/kg intravenously every 4 weeks.

TABLE 338 Trial characteristics: populations 2 and 3 biologics vs. DMARD(s) or PBO

Trial name/study (NCT/sponsor number)	Trial design (RCT, phase, LTE)	Treatment arms for which data extraction performed (number of patients randomised per treatment arm)	MTX dose during study (where applicable)	Concomitant treatments	Duration of RCT phase	Primary outcome	Early withdrawal plan reported?	Geographical location	Funding source	Primary and supplementary publication details (author, year, publication type (e.g. full, abstract))
AIM <sup>61,62</sup> (NCT00048568)	Randomised, double-blind, PBO-controlled trial  Confirmatory Phase III	MTX + PBO (n = 219)	15.7 (SD 3.5) mg/week	Patients were permitted to continue taking oral corticosteroids, provided that the prescribed dose was reduced to the equivalent of 10 mg of prednisone daily for 28 days	12 months	Health-related quality of life	NR	USA and Europe (including UK)	Bristol-Myers Squibb	Russell <i>et al.</i> , 2007 <sup>61</sup>  Kremer <i>et al.</i> , 2006 <sup>62</sup>
AIM <sup>61</sup>		ABT i.v. + MTX (n = 433)	16.1 (SD 3.6) mg/week							
ASSET <sup>72</sup>	RCT (Phase IIIb)	PBO + MTX (n = 23 randomised)	10–25 mg/week, mean dose at baseline 17.3 (SD 4.2) mg/week	MTX (100%), oral and/or injectable corticosteroids (60.9%), low-dose oral corticosteroids (52.2%), NSAIDs (87.0%)	4 months	Reduction in wrist synovitis score from mean magnetic resonance imaging scores at baseline and month 4	No	Europe	Bristol-Myers Squibb	Conaghan <i>et al.</i> , 2013 <sup>72</sup> full-text paper
ASSET <sup>72</sup>		ABT i.v. (≈10 mg/kg) + MTX (n = 27 randomised)	10–25 mg/week, mean dose at baseline 16.9 (SD 4.6) mg/week	MTX (100%), oral and/or injectable corticosteroids (70.4%), low-dose oral corticosteroids (59.3%), NSAIDs (81.5%)						
ASSURE <sup>73</sup>	RCT	PBO + cDMARDs (n = 482 treated)	NR	MTX, HCQ, chloroquine, SSZ, LEF, GLD, AZA (ETN, IFX, ADA)	1 year	Safety	No	NR	Bristol-Myers Squibb	Weinblatt <i>et al.</i> , 2006 <sup>73</sup> full-text paper
ASSURE <sup>73</sup>		ABT + cDMARDs (n = 959 treated)	NR	MTX, HCQ, chloroquine, SSZ, LEF, GLD, AZA (ETN, IFX, ADA)						



Trial name/study (NCT/sponsor number)	Trial design (RCT, phase, LTE)	Treatment arms for which data extraction performed (number of patients randomised per treatment arm)	MTX dose during study (where applicable)	Concomitant treatments	Duration of RCT phase	Primary outcome	Early withdrawal plan reported?	Geographical location	Funding source	Primary and supplementary publication details (author, year, publication type (e.g. full, abstract))
AUGUST II <sup>76</sup> (NCT00595413)	Phase II, randomised, PBO-controlled trial	MTX + PBO (n = 76)	NR	Allowed steroids unless prednisone dosage > 10 mg/day (or equivalent) or change in steroid or NSAID dosing regimen ≤ 28 days before study day 1	25 weeks	Proportion of patients with 20% improvement in disease severity according to the ACR criteria, as assessed using the CRP level (ACR20-CRP)	NR	Europe and USA	Merck Serono, Geneva, Switzerland and EMD Serono, Rockland, MA, which are affiliates of Merck KGaA, Darmstadt, Germany	van Vollenhoven <i>et al.</i> , 2011 <sup>76</sup> full-text article in peer-reviewed journal
AUGUST II <sup>76</sup>		ADA + MTX (n = 79)	NR							
CHANGE/ Miyasaka, 2008 <sup>80</sup>	Phase II/III, multicenter, double-blind, PBO-controlled trial	PBO (n = 87)	N/A	Steroids allowed	24 weeks	ACR20 response rate at week 24	Patients who experienced an increase in disease activity or who had less than 10% reduction in tender joint counts and swollen joint counts compared with baseline after at least 8 weeks of treatment stopped study therapy with ADA/PBO and were switched to an open-label rescue treatment that could include higher doses of steroids, NSAIDs, or cDMARDs	Japan	Abbott, Osaka, Japan, and Eisai, Tokyo, Japan	Miyasaka, 2008 <sup>80</sup> full-text article in peer-reviewed journal
CHANGE <sup>80</sup>		ADA monotherapy (n = 91)	N/A							

continued

TABLE 338 Trial characteristics: populations 2 and 3 biologics vs. DMARD(s) or PBO (continued)

Trial name/study (NCT/sponsor number)	Trial design (RCT, phase, LTE)	Treatment arms for which data extraction performed (number of patients randomised per treatment arm)	MTX dose during study (where applicable)	Concomitant treatments	Duration of RCT phase	Primary outcome	Early withdrawal plan reported?	Geographical location	Funding source	Primary and supplementary publication details (author, year, publication type (e.g. full, abstract))
DE019/Keystone <i>et al.</i> , 2004 <sup>84</sup> (NCT00195702)	Phase III, multicenter, double-blind, PBO-controlled study	MTX + PBO (n = 200)	16.7 (4.1) mg/week	Doses and routes of administration of concomitant RA therapies, such as MTX, corticosteroids and NSAIDs were kept constant throughout the study  Oral corticosteroids, if used previously, were allowed at a maximum prednisone-dose equivalent of 10 mg/day	52 weeks	Radiographic progression at week 52 (total Sharp score by a modified method), clinical response at week 24 (improvements of at least 20% in the ACR core criteria) and physical function at week 52 (disability index of the HAQ)	At week 16 or thereafter, patients who were not achieving an ACR20 response (improvements of at least 20% in the ACR core criteria) were allowed to receive 'rescue' treatment with a traditional DMARD at the discretion of their treating physician	USA and Canada	Abbott Laboratories, Abbott Park, IL	Keystone <i>et al.</i> , 2004 <sup>84</sup> full-text article in peer-reviewed journal
DE019 <sup>84</sup>		ADA + MTX (n = 207)	16.7 (SD 4.5) weekly dose mg/kg							

Trial name/study (NCT/sponsor number)	Trial design (RCT, phase, LTE)	Treatment arms for which data extraction performed (number of patients randomised per treatment arm)	MTX dose during study (where applicable)	Concomitant treatments	Duration of RCT phase	Primary outcome	Early withdrawal plan reported?	Geographical location	Funding source	Primary and supplementary publication details (author, year, publication type (eg, full, abstract))
STAR <sup>117</sup> 2003 <sup>117</sup>	Randomised, double-blind, PBO-controlled trial	PBO + cDMARDs (n = 318)	Number of traditional DMARDs: 0 DMARDs, n = 48 (15.1%) 1 DMARD, n = 172 (54.1%) 2 DMARDs, n = 84 (26.4%) 3+ DMARDs, n = 14 (4.4%) Mean number of DMARDs 1.2	Patients continued to receive their baseline doses of standard antirheumatic therapy, which could include traditional DMARD, low-dose corticosteroids (prednisone equivalent dose ≤ 10 mg/day), NSAID, and/or analgesics. Treatment with traditional DMARDs permitted during the study included chloroquine, HCQ, LEF, MTX, parenteral GLD, oral GLD, SSZ, or any combination of these. Doses of traditional DMARDs, corticosteroids, NSAID, and/or analgesics must have been stable for at least 28 days before screening	24 weeks	Frequencies of AEs, serious AEs, severe or life-threatening AEs, AEs leading to withdrawal, or infection, or serious infection	NR	USA	Abbott Laboratories, Abbott Park, IL	Furst <i>et al.</i> , 2003 <sup>117</sup> full-text article in peer-reviewed journal
STAR <sup>117</sup>		ADA + cDMARDs (n = 318)	Number of traditional DMARDs: 0 DMARDs, n = 57 (17.9%) 1 DMARD, n = 184 (57.9%) 2 DMARDs, n = 66 (20.8%) 3+ DMARDs, n = 11 (3.5%) Mean number of DMARDs 1.1							

continued

TABLE 338 Trial characteristics: populations 2 and 3 biologics vs. DMARD(s) or PBO (continued)

Trial name/study (NCT/sponsor number)	Trial design (RCT, phase, LTE)	Treatment arms for which data extraction performed (number of patients randomised per treatment arm)	MTX dose during study (where applicable)	Concomitant treatments	Duration of RCT phase	Primary outcome	Early withdrawal plan reported?	Geographical location	Funding source	Primary and supplementary publication details (author, year, publication type (e.g. full, abstract))
Van De Putte <i>et al.</i> , 2004 <sup>122</sup>	RCT (Phase III, double blind)	PBO s.c. (n = 110 randomised)	NR	Use of NSAIDs and oral corticosteroids before study permitted at stable doses (up to 10 mg/day of prednisolone or equivalent). Analgesics permitted (not within 12 hours of study visits)	26 weeks	ACR20 response at week 26	Yes (ADA or PBO patients with increased inflammatory synovitis or < 10% improvement in tender joint counts and swollen joint counts after > 8 weeks treatment could enter rescue arm, during which study drug could be discontinued and doses of NSAIDs/corticosteroids increased/other DMARDs initiated at physician's discretion)	Multicentre, multinational (Europe, Canada, Australia)	Abbott	Van De Putte <i>et al.</i> , 2004 <sup>122</sup> full publication
Van De Putte <i>et al.</i> , 2004 <sup>122</sup>		ADA monotherapy (n = 113 randomised)	NR							
ARMADA <sup>69,70</sup>	Randomised, double-blind, PBO-controlled trial Phase II/III	MTX + PBO (n = 62)	16.5 (SD 5.0) mg/week	Salicylates, NSAIDs and corticosteroids (maximum daily dose of 10 mg of oral prednisone or equivalent) Folic acid or leucovorin was permitted	24 week	ACR criteria for 20% improvement (ACR20) at 24 weeks	Patients who failed to meet or to maintain an ACR20 response but had received study drug (ADA or PBO) for at least 16 weeks were eligible to remain in the study or to roll over to an open-label continuation study with ADA	USA and Canada	Abbott Laboratories and Knoll Pharmaceuticals	Weinblatt <i>et al.</i> , 2003 <sup>69</sup> full-text article in peer-reviewed journal
ARMADA <sup>69</sup>		ADA + MTX (n = 67)	16.4 (SD 4.1) mg/week							

Trial name/study (NCT/sponsor number)	Trial design (RCT, phase, LTE)	Treatment arms for which data extraction performed (number of patients randomised per treatment arm)	MTX dose during study (where applicable)	Concomitant treatments	Duration of RCT phase	Primary outcome	Early withdrawal plan reported?	Geographical location	Funding source	Primary and supplementary publication details (author, year, publication type (e.g. full, abstract))
Kim <i>et al.</i> , 2007 <sup>99</sup>	Phase III, randomised, double-blind, PBO-controlled study	MTX + PBO rescue week 18 (n = 65)	16.3 (3.4) mg/week	NR	24 weeks	20% improvement in the ACR response criteria (ACR20) at week 24	Beginning at week 18, patients with non-response could discontinue their double-blind study medication and switch to rescue therapy with open-label ADA 40 mg s.c. every other week	Republic of Korea	Abbott Laboratories, Abbott Park, IL	Kim <i>et al.</i> , 2007 <sup>99</sup> full-text article in peer-reviewed journal
Kim <i>et al.</i> , 2007 <sup>99</sup>		ADA + MTX (n = 63)	16.6 (3.3) mg/week							
CERTAIN <sup>79</sup> (NCT00674362)	RCT (Phase IIb)	PBO + cDMARDs (n = 98 randomised)	N/A	Existing cDMARDs	52 weeks	% patients in Clinical Disease Activity Index remission at weeks 20 and 24 (≤ 2.8)	Patients in Clinical Disease Activity Index remission at weeks 20 and 24 stopped CTZ and were monitored to week 52	NR	UCB	Smolen <i>et al.</i> , 2011 <sup>79</sup> abstract Emery <i>et al.</i> , 2012 <sup>79,15</sup> abstract
CERTAIN <sup>79</sup>		CTZ 400 mg at weeks 0, 2 and 4 then 200 mg every 2 weeks + DIMARDs (n = 96 randomised)	N/A	Existing cDMARDs						
REALISTIC <sup>113</sup>	RCT (Phase III)	PBO + existing cDMARDs	N/A	MTX, LEF, SSZ, chloroquine, HCQ, AZA, GLD, steroids, NSAIDs	12 weeks	ACR20 at 12 weeks	N/A (12-week study)	USA, Canada and Europe	UCB	Weinblatt <i>et al.</i> , 2012 <sup>113</sup> abstract
REALISTIC <sup>113</sup>		CTZ 400 mg weeks 0, 2, 4 then 200 mg every 2 weeks + existing cDMARDs		MTX, LEF, SSZ, chloroquine, HCQ, AZA, GLD, steroids, NSAIDs						

continued

**TABLE 338** Trial characteristics: populations 2 and 3 biologics vs. DMARD(s) or PBO (continued)

Trial name/study number (NCT/sponsor number)	Trial design (RCT, phase, LTE)	Treatment arms for which data extraction performed (number of patients randomised per treatment arm)	MTX dose during study (where applicable)	Concomitant treatments	Duration of RCT phase	Primary outcome	Early withdrawal plan reported?	Geographical location	Funding source	Primary and supplementary publication details (author, year, publication type (e.g. full, abstract))
ADORE <sup>59,60</sup>	Prospective, 16 week, randomised, open-label, parallel group, outpatient study	ETN monotherapy (n = 160) (n = 159 received treatment and provided data)	N/A	NSAIDs and corticosteroids allowed	16 weeks	The primary efficacy measure was the proportion of evaluable patients in each treatment group who achieved an improvement of > 1.2 units in DAS28 from baseline to week 16	NR	60 centres in eight countries (Denmark, Finland, France, Germany, the Netherlands, Turkey, UK and Spain)	Wyeth Research	van Riel et al., 2006 <sup>59</sup> full-text article in peer-reviewed journal  van Riel et al., 2008 <sup>60</sup> full-text article in peer-reviewed journal
ADORE <sup>59</sup>		ETN + MTX (n = 155)	MTX ( $\geq$ 12.5 mg/week orally or by injection)							
CREATE IIb <sup>96</sup> [D1520C00001; NCT00520572 (Phase IIa and IIb trials)]	Phase IIb study was a randomised, double-blind, PBO controlled, parallel-group multicentre trial (with an open-label ETN treatment group) to evaluate the efficacy of four doses of AZD9056 administered for 6 months on background MTX or sulphasalazine	DMARD + PBO (n = 65)	Median 15 mg/week  Patients were required to have received MTX for $\geq$ 6 months (the dose must have been stable between 5 and 25 mg/week for $\geq$ 6 weeks) or sulphasalazine for $\geq$ 16 weeks (at a stable dose of 0.5–3 g/day for $\geq$ 6 weeks) prior to randomisation	Concurrent treatment with stable doses of NSAIDs and/or prednisone (maximum 10 mg daily) was allowed throughout the study	6 months	The proportion of patients meeting ACR 20% response criteria (ACR20) at 6 months (based on 28 joint counts)	NR	Canada and UK	AstraZeneca	Keystone et al., 2012 <sup>96</sup> full-text article in peer-reviewed journal

Trial name/study (NCT/sponsor number)	Trial design (RCT, phase, LTE)	Treatment arms for which data extraction performed (number of patients randomised per treatment arm)	MTX dose during study (where applicable)	Concomitant treatments	Duration of RCT phase	Primary outcome	Early withdrawal plan reported?	Geographical location	Funding source	Primary and supplementary publication details (author, year, publication type (eg, full, abstract))
CREATE IIb <sup>96</sup>		ETN50 + DMARD (n = 64)  Note either MTX across both arms (89.8%) or SSZ (9.7%) used as DMARD (not both)								
ETN study 309 <sup>89</sup>	Randomised, double-blind, controlled trial	SSZ + PBO (n = 50)	SSZ dose (g/day), mean (SD) 2.1 (0.4)	Patients were permitted stable doses of oral corticosteroids (10 mg/day of prednisone or equivalent), one NSAID, simple analgesics with no anti-inflammatory action or daily doses of aspirin (300 mg) during the study	2 years	Percentage of patients achieving > 20% improvement as assessed by the ACR20 response at week 24	NR	Europe (including UK), Australia, USA	Wyeth Research, Collegeville, PA	Combe et al., 2006 <sup>88</sup> full-text article in peer-reviewed journal  Combe et al., 2009 <sup>88</sup> full-text article in peer-reviewed journal
ETN study 309 <sup>89</sup>		ETN + PBO (n = 103)	N/A							
ETN study 309 <sup>89</sup>		ETN + SSZ (n = 101)	SSZ dose (g/day), mean (SD) 2.1 (0.5)							
JESMR <sup>140</sup>	RCT (Phase IV)	ETN monotherapy (n = 74 randomised)	7.0 (1.4) mg/week	Folic acid (37.7%), corticosteroids (46.4%)	52 weeks	Good EULAR response and ACR50 response at week 24	No	Japan	Japanese Ministry of Health, Labour and Welfare	Kameda et al., 2010 <sup>116</sup> full-text paper  Kameda et al., 2011 <sup>140</sup> full-text paper
JESMR <sup>140</sup>		ETN + MTX 6–8 mg/week (n = 77 randomised)	7.4 (1.1) mg/week	Folic acid (52.1%), corticosteroids (60.3%)						
Lan et al., 2004 <sup>101</sup>	RCT, double blind	PBO + MTX (n = 29)	12.5–20 mg/week	NSAIDs, aspirin and corticosteroids were allowed	12 weeks	Reduction of tender and swollen joint counts by 20% (ACR20), 50%, 70% at 12 weeks	NR	Taiwan	Wyeth-Ayerst Ltd, Taiwan branch	Lan et al., 2004 <sup>101</sup> full-text article in peer-reviewed journal

continued

TABLE 338 Trial characteristics: populations 2 and 3 biologics vs. DMARD(s) or PBO (continued)

Trial name/study (NCT/sponsor number)	Trial design (RCT, phase, LTE)	Treatment arms for which data extraction performed (number of patients randomised per treatment arm)	MTX dose during study (where applicable)	Concomitant treatments	Duration of RCT phase	Primary outcome	Early withdrawal plan reported?	Geographical location	Funding source	Primary and supplementary publication details (author, year, publication type (e.g. full, abstract))
Lan <i>et al.</i> , 2004 <sup>101</sup>		ETN + MTX (n = 29)								
LARA <sup>102</sup> (NCT00848354)	Randomised, open-label, active-comparator study	MTX + DMARD (n = 142)	14.4 (3.9) mg/week	NR	24 weeks	Proportion of subjects achieving ACR50 criteria at week 24	NR	Latin American region (Argentina, Chile, Colombia, Mexico, Panama)	Wyeth	Machado <i>et al.</i> , 2012 <sup>102</sup> conference abstract
LARA <sup>102</sup>	Phase IV	ETN50 + MTX (n = 281)	14.1 (3.8) mg/week							
Moreland <i>et al.</i> , 1999, <sup>104</sup> Mathias <i>et al.</i> , 2000 <sup>105</sup>	Confirmatory, Phase III, randomised, double-blind, PBO-controlled trial	PBO (n = 80)	N/A	Corticosteroids and NSAIDs allowed	6 months	20% and 50% improvement ACR, at 3 months and 6 months	NR	USA	Immunex Corp, Seattle, WA	Moreland <i>et al.</i> , 1999 <sup>104</sup> full-text article in peer-reviewed journal Mathias <i>et al.</i> , 2000 <sup>105</sup> full-text article in peer-reviewed journal
Moreland <i>et al.</i> , 1999, <sup>104</sup> Mathias <i>et al.</i> , 2000 <sup>105</sup>		ETN + PBO (n = 78)	N/A							



Trial name/study (NCT/sponsor number)	Trial design (RCT, phase, LTE)	Treatment arms for which data extraction performed (number of patients randomised per treatment arm)	MTX dose during study (where applicable)	Concomitant treatments	Duration of RCT phase	Primary outcome	Early withdrawal plan reported?	Geographical location	Funding source	Primary and supplementary publication details (author, year, publication type (e.g. full, abstract))
RACAT, <sup>11</sup> O'Dell <i>et al.</i> , 2013 <sup>12</sup> (NCT00405275)	Randomised, double-blind, PBO-controlled, non-inferiority trial	MTX + SSZ + HCQ (n = 178) Potential to switch groups at week 24	19.5 (5.0) mg/week	Participants continued to receive non-steroidal anti-inflammatory agents and prednisone (≤ 10 mg/day) at stable doses	48 weeks	The originally proposed primary outcome was the difference in the proportion of participants who had a DAS28 of ≤ 3.2 at week 48. In response to unexpectedly low enrolment, the protocol was amended in October 2008 to change the primary outcome from a binary outcome to a continuous outcome in order to increase the power of the study	Part of study design – if the score on the DAS28 decreased (indicating improvement) by 1.2 or more by 24 weeks, the initial therapy was continued. If the score on the DAS28 decreased by < 1.2, the participant was switched to the alternative regimen	USA and Canada	Supported by the Cooperative Studies Program, Department of Veterans Affairs Office of Research and Development and the Canadian Institutes for Health Research and by an interagency agreement with the National Institutes of Health–American Recovery and Reinvestment Act	O'Dell <i>et al.</i> , 2013 <sup>12</sup> full-text article in peer-reviewed journal O'Dell <i>et al.</i> , 2012 <sup>11</sup> conference abstract
RACAT <sup>11</sup>		ETN50 + MTX (n = 175) Potential to switch groups at week 24	19.7 (4.5) mg/week							
Wajidula 2000 (reported in Chen <i>et al.</i> , 2006 <sup>123</sup> ) European Etanercept Investigators Group protocol 088TA1–300-EU Wajidula 2000 (reported in Chen <i>et al.</i> , 2006 <sup>123</sup> )	RCT, multicentre, double blind	PBO (n = 105) ETN (n = 111)			12 weeks	Change from baseline in the number of swollen and painful joints at 3 months	N/A (12-week study)	Europe, multicentre		Information taken from a published HTA report that had access to manufacturer trial reports Chen <i>et al.</i> , 2006 <sup>123</sup>

continued

TABLE 338 Trial characteristics: populations 2 and 3 biologics vs. DMARD(s) or PBO (continued)

Trial name/study (NCT/sponsor number)	Trial design (RCT, phase, LTE)	Treatment arms for which data extraction performed (number of patients randomised per treatment arm)	MTX dose during study (where applicable)	Concomitant treatments	Duration of RCT phase	Primary outcome	Early withdrawal plan reported?	Geographical location	Funding source	Primary and supplementary publication details (author, year, publication type (e.g. full, abstract))
Weinblatt <i>et al.</i> , 1999 <sup>24</sup>	RCT, double blind	MTX + PBO (n = 30)	Stable dose 12.5–25 mg/week	NSAIDs and corticosteroids allowed	24 weeks	ACR criteria for a 20% improvement in measures of disease activity (ACR20) at 24 weeks	Condition not described; patients who received intra-articular injections of corticosteroids during the study were counted as having or not having a response according to their overall evaluation	Multicentre, USA	Supported by Immunex	Weinblatt <i>et al.</i> , 1999 <sup>24</sup> full-text article in peer-reviewed journal  Kremer <i>et al.</i> , 2003 <sup>60</sup> full-text article in peer-reviewed journal
Weinblatt <i>et al.</i> , 1999 <sup>24</sup>		ETN + MTX (n = 59)								
APPEAL <sup>67,68</sup>	Open-label, active-comparator, parallel-design, multicentre RCT	MTX + DMARD (SSZ, HCQ or LEF) (n = 103)	6.9 (8.5) mg/week	NSAIDs or corticosteroids were allowed, but not multiple NSAIDs, and any increase in dosage of baseline NSAID or corticosteroid	16 weeks	ACR response area under the curve over 16 weeks	NR	Asia – Pacific region	Wyeth	Kim <i>et al.</i> , 2012 <sup>67</sup> full-text article in peer-reviewed journal  Bae <i>et al.</i> , 2013 <sup>68</sup> full-text article in peer-reviewed journal
APPEAL <sup>68</sup>		ETN + MTX (n = 197)	6.5 (7.3) mg/week							
GO-FORTH <sup>91</sup>	RCT (Phase II/III)	PBO every 4 weeks + MTX 6–8 mg/week (n = 90 randomised)	NR	Concurrent NSAIDs, analgesic and oral corticosteroids (≤10 mg of prednisolone/day or equivalent) allowed with stable doses ≥ 2 weeks prior to and during the study	24 weeks	ACR20 response at week 14	Patients with <20% improvement from baseline in tender joint counts and swollen joint counts at week 14 could enter double-blind early escape where the dose was increased (or added in PBO arm)	Japan	Centocor Research & Development Inc., Janssen Pharmaceuticals K.K. and Mitsubishi Tanabe Pharmaceutical Corporation	Tanaka <i>et al.</i> , 2012 <sup>91</sup> full-text paper
GO-FORTH <sup>91</sup>		GOL 50 mg s.c. every 4 weeks + MTX 6–8 mg/week (n = 89 randomised)	NR							

Trial name/study (NCT/sponsor number)	Trial design (RCT, phase, LTE)	Treatment arms for which data extraction performed (number of patients randomised per treatment arm)	MTX dose during study (where applicable)	Concomitant treatments	Duration of RCT phase	Primary outcome	Early withdrawal plan reported?	Geographical location	Funding source	Primary and supplementary publication details (author, year, publication type (e.g. full, abstract))
GO-FORWARD <sup>92</sup> (NCT00264550)	RCT (Phase III, double blind)	PBO s.c. every 4 weeks + MTX (n = 133 randomised)	Mean (SD) 17.0 (2.75) mg/week Median 15.0 (IQR 15.0–20.0)	Patients receiving NSAIDs or other analgesics for RA required to have been taking stable dose for at least 2 weeks before first dose of study agent  Patients receiving oral corticosteroids required to have been taking stable dose equivalent to 10 mg/day or less of prednisone for at least 2 weeks before first dose of study drug	Double-blind, PBO-controlled phase to week 24 and open-label extension up to 5 years	Two co primary end points: proportion of patients achieving ACR20 response at week 14 and improvement from baseline in HAQ-DI score at week 24	Yes	Multinational, multicentre (60 sites over 12 countries)	Centocor	Keystone <i>et al.</i> , 2009 <sup>216</sup> full publication, results to week 24  Keystone <i>et al.</i> , 2010 <sup>92</sup> full publication, results to week 52
GO-FORWARD <sup>92</sup>		GOL 50 mg s.c. every 4 weeks + MTX (n = 89 randomised)	Mean (SD) 17.4 (3.00) mg/week Median 15.0 (IQR 15.0–20.0) mg/week							
Kay <i>et al.</i> , 2008 <sup>98</sup> (NCT00207714)	RCT (Phase II, double blind)	PBO s.c. + MTX (n = 35 randomised)	All patients continued to receive stable doses of MTX (at least 10 mg/week) through end of study	Oral corticosteroids permitted at stable pre-study dosage not exceeding equivalent 10 mg prednisone per day  Commercially available NSAIDs permitted at stable pre-study dose  Folic acid at stable dosage of at least 5 mg every week for at least 4 weeks before first study drug dose	52 weeks	Proportion of patients meeting ACR 20% improvement criteria (achieving an ACR20 response) at week 16	Yes	Multicentre [40 study sites, geographical location(s) not stated]	Centocor	Kay <i>et al.</i> , 2008 <sup>98</sup> full publication

continued

TABLE 338 Trial characteristics: populations 2 and 3 biologics vs. DMARD(s) or PBO (continued)

Trial name/study (NCT/sponsor number)	Trial design (RCT, phase, LTE)	Treatment arms for which data extraction performed (number of patients randomised per treatment arm)	MTX dose during study (where applicable)	Concomitant treatments	Duration of RCT phase	Primary outcome	Early withdrawal plan reported?	Geographical location	Funding source	Primary and supplementary publication details (author, year, publication type (e.g. full, abstract))
Kay <i>et al.</i> , 2008 <sup>98</sup>		GOL 50 mg s.c. every 4 weeks + MTX (n = 35 randomised)								
Abe <i>et al.</i> , 2006 <sup>56</sup>	RCT (phase NR, double blind)	PBO + MTX (n randomised NR, 47 patients received one or more infusions)	7.4 (SD = 2.2) mg/week	Patients taking NSAIDs, folic acid or corticosteroids (10 mg/day or less of prednisolone equivalent) required to have received stable dose for at least 4 weeks before study entry	14 weeks	ACR20 response at week 14	No	Multicentre, Japan	NR	Abe <i>et al.</i> , 2006 <sup>56</sup> full publication
Abe <i>et al.</i> , 2006 <sup>56</sup>		IFX 3 mg/kg i.v. at weeks 0, 2 and 6 + MTX (n randomised NR, 49 patients received one or more infusions)	7.1 (SD = 1.9) mg/week							
ATTRACT <sup>75</sup>	RCT (Phase III, double blind)	PBO i.v. + MTX (n = 88 randomised)	Median 15 (IQR 12.5–17.5) mg/week	Patients receiving oral corticosteroids (10 mg/kg or less of prednisone equivalent) or NSAIDs required to have stable dose for at least 4 weeks before screening (and must not have received either drug for at least 4 weeks before screening)	54-week PBO-controlled RCT with LTE to 102 weeks	ACR20 response at week 30 without requiring a surgical joint procedure, initiation of new antirheumatic drugs or increased in antirheumatic drugs	No	Multicentre, multinational	Centocor	Maini <i>et al.</i> , 1999 <sup>75</sup> full publication
				Patients received baseline dose of MTX or corticosteroids during study		ACR20 response at week 30				

Trial name/study (NCT/sponsor number)	Trial design (RCT, phase, LTE)	Treatment arms for which data extraction performed (number of patients randomised per treatment arm)	MTX dose during study (where applicable)	Concomitant treatments	Duration of RCT phase	Primary outcome	Early withdrawal plan reported?	Geographical location	Funding source	Primary and supplementary publication details (author, year, publication type (e.g. full, abstract))
ATTRACT <sup>75</sup>		IFX 3 mg/kg i.v. at weeks 0, 2 and 6 and every 8 weeks thereafter + MTX (n = 86 randomised)	Median 15 (IQR 12.5–17.5) mg/week							
Durez <i>et al.</i> , 2004 <sup>86</sup>	RCT (Phase NR, open label)	Single i.v. infusion of 1 g of MP (sodium hemisuccinate) at week 0 + MTX (n = 14 randomised)	Median 12.5 (range 10–15) mg/week	Oral glucocorticoid doses remained unaltered during study. Intra-articular steroids not permitted. Introduction of new NSAID or DMARD not permitted	14 weeks	NR	No	Belgium	Schering-Plough	Durez <i>et al.</i> , 2004 <sup>86</sup> full publication
Durez <i>et al.</i> , 2004 <sup>86</sup>		IFX 3 mg/kg at weeks 0, 2 and 6 + MTX (n = 12 randomised)	Median 15 (range 10–15) mg/week							
START <sup>118</sup>	RCT	PBO + MTX (n = 363 randomised)	Median 15.0 (IQR 10–15) mg/week	MTX only (70.0%), MTX + one DMARD (25.3%), MTX + two DMARDs (4.4%), NSAIDs (39.4%), corticosteroids (59.2%), narcotics/opioid analgesics (6.1%)	1 year (22 weeks before dose escalation commenced)	Occurrence of a serious infection within 22 weeks of initiating therapy	No, but dose escalation from 22 weeks if <20% improvement in swollen joint counts and tender joint counts or ≥50% discontinuation in improvement in combined swollen joint counts and tender joint counts	NR	Centocor Research and Development Inc.	Westhovens <i>et al.</i> , 2006 <sup>118</sup> full-text paper
START <sup>118</sup>		IFX 3 mg/kg + MTX (n = 360 randomised)	Median 15.0 (IQR 10–18) mg/week	MTX only (70.8%), MTX + one DMARD (24.4%), MTX + two DMARDs (4.7%), NSAIDs (43.3%), corticosteroids (59.2%), narcotics/opioid analgesics (5.8%)						

continued

TABLE 338 Trial characteristics: populations 2 and 3 biologics vs. DMARD(s) or PBO (continued)

Trial name/study (NCT/sponsor number)	Trial design (RCT, phase, LTE)	Treatment arms for which data extraction performed (number of patients randomised per treatment arm)	MTX dose during study (where applicable)	Concomitant treatments	Duration of RCT phase	Primary outcome	Early withdrawal plan reported?	Geographical location	Funding source	Primary and supplementary publication details [author, year, publication type (e.g. full, abstract)]
Swefot <sup>119</sup> (WHO database number CT20080004)	RCT (Phase NR, open label)	SSZ (1000 mg twice daily orally) + HCQ (400 mg daily orally) + MTX (with optional increase to SSZ 1500 mg twice daily if ineffective and cDMARD adjustment in event of toxicity with potential switch to CYC (five switched to CYC, included in primary analyses) (n = 130)	Up to 20 mg/week	If patients were receiving glucocorticoids, dose was required to be stable for at least 4 weeks at no more than 10 mg daily of prednisolone (or equivalent)	2 years	EULAR good response at 12 months	Dose adjustments permitted (see left)	Multicentre (15 rheumatology units), Sweden	Swedish Rheumatism Association Schering-Plough	van Vollenhoven <i>et al.</i> , 2009 <sup>119</sup> van Vollenhoven <i>et al.</i> , 2012 <sup>147</sup> full publication
Swefot <sup>119</sup>		IFX 3 mg/kg i.v. at weeks 0, 2, 6 and every 8 weeks thereafter with optional increase to IFX every 6 weeks thereafter (in event of toxicity, optional switch to ETN 50 mg weekly) (five switched to ETN, included in primary analyses) + MTX (n = 128)								
Wong <i>et al.</i> , 2009 <sup>125</sup>	RCT (Phase NR, double blind)	PBO + MTX (with crossover to open-label IFX at week 24) (n = 9)	NR	All antirheumatic medications kept stable for at least 4 weeks before and during study (unless dose alterations were clinically indicated)	56 weeks	Vascular ultrasound assessments at weeks 24 and 56	Yes (PBO patients could escape to open-label IFX at week 16)	UK	Centocor Pty Ltd Arthritis Foundation of Australia	Wong <i>et al.</i> , 2009 <sup>125</sup> full publication
Wong <i>et al.</i> , 2009 <sup>125</sup>		IFX 3 mg/kg at weeks 0, 2, 6 and 8 weeks thereafter + MTX (n = 17)								

Trial name/study (NCT/sponsor number)	Trial design (RCT, phase, LTE)	Treatment arms for which data extraction performed (number of patients randomised per treatment arm)	MTX dose during study (where applicable)	Concomitant treatments	Duration of RCT phase	Primary outcome	Early withdrawal plan reported?	Geographical location	Funding source	Primary and supplementary publication details [author, year, publication type (e.g. full, abstract)]
Zhang <i>et al.</i> , 2006 <sup>26</sup>	RCT (Phase NR, double blind)	PBO i.v. + MTX (n=86)	Stable dose of MTX continued during study	Glucocorticosteroid dose required to be stable for 4 weeks before screening and dosage not permitted to exceed 10 mg/day of prednisone or equivalent	18 weeks	NR	No	Multicentre (five centres), China		Zhang <i>et al.</i> , 2006 <sup>26</sup> full publication
Zhang <i>et al.</i> , 2006 <sup>26</sup>		IFX 3 mg/kg i.v. at weeks 0, 2, 6 and 14 + MTX (n = 87)								
ACT-RA <sup>57</sup> (NCT00810199)	RCT (Phase III, double blind)	TCZ 8 mg/kg i.v. every 4 weeks + oral PBO (n = 277 randomised)	Patients received mean weekly doses of MTX/PBO ranging from: TCZ 8 mg/kg i.v. every 4 weeks + oral PBO = 15.8–16.3 mg/week; TCZ 8 mg/kg i.v. every 4 weeks + MTX = 15.2–15.9 mg/week	Oral corticosteroids ( $\leq 10$ mg/day of prednisone or equivalent) and NSAIDs permitted if doses had been stable for at least 25 of 28 days before start of study agent	2 years	% patients in remission according to DAS28-ESR (DAS28 < 2.6) at week 24	No	NR	Roche	Douados <i>et al.</i> , 2013 <sup>57</sup> full publication
ACT-RA <sup>57</sup>		TCZ 8 mg/kg i.v. every 4 weeks + MTX (n = 276)								
MEASURE <sup>103</sup>	RCT (Phase NR, double blind)	PBO + MTX (n = 69 randomised)	NR	NR	24 weeks double-blind phase of 2-year study	NR	Yes (27 patients in PBO arm entered early escape treatment with open-label TCZ at week 16)	UK, USA, Canada	Lead author: grant/research support from Roche	McInnes <i>et al.</i> , 2011 <sup>103</sup> conference abstract
MEASURE <sup>103</sup>		TCZ 8 mg/kg i.v. every 4 weeks + MTX (n = 69 randomised)	NR							

continued

TABLE 338 Trial characteristics: populations 2 and 3 biologics vs. DMARD(s) or PBO (continued)

Trial name/study (NCT/sponsor number)	Trial design (RCT, phase, LTE)	Treatment arms for which data extraction performed (number of patients randomised per treatment arm)	MTX dose during study (where applicable)	Concomitant treatments	Duration of RCT phase	Primary outcome	Early withdrawal plan reported?	Geographical location	Funding source	Primary and supplementary publication details [author, year, publication type (e.g. full, abstract)]
Nishimoto <i>et al.</i> , 2004 <sup>106</sup>	RCT (phase NR, double blind)	PBO i.v. every 4 weeks (n = 53 randomised)	N/A	Stable prednisolone ( $\leq 10$ mg/day) and NSAIDs permitted at stable doses  No parenteral and/or intra-articular corticosteroids permitted during 4-week washout period before initiation of study agent and during study period	3 months	ACR20 at week 12	No	Multicentre, Japan	Chugai Pharmaceutical, Japan	Nishimoto <i>et al.</i> , 2004 <sup>106</sup> full publication
Nishimoto <i>et al.</i> , 2004		TCZ 8 mg/kg i.v. every 4 weeks (n = 55 randomised)	N/A							
SAMURAI <sup>115</sup>	Multicentre, X-ray reader-blinded, randomised, controlled trial Phase III	cDMARDs disease activity (n = 145)	8.0 ( $\pm 2.1$ ) mg/week 123 patients (85%) received MTX; 81 (56%) received a combination of MTX and DMARDs; 42 (29%) received MTX monotherapy and 20 (14%) received DMARDs and/or immunosuppressants other than MTX, besides corticosteroids	For the conventional DMARD group, the dose, type and combination of DMARDs and/or immunosuppressants, except for antiTNF agents and LEF, could be varied according to disease activity at the discretion of the treating physician	52 weeks	Progression of structural joint damage	NR	Japan	Chugai Pharmaceutical, Tokyo, Japan	Nishimoto <i>et al.</i> , 2007 <sup>115</sup> full-text article in peer-reviewed journal



Trial name/study (NCT/sponsor number)	Trial design (RCT, phase, LTE)	Treatment arms for which data extraction performed (number of patients randomised per treatment arm)	MTX dose during study (where applicable)	Concomitant treatments	Duration of RCT phase	Primary outcome	Early withdrawal plan reported?	Geographical location	Funding source	Primary and supplementary publication details (author, year, publication type (e.g. full, abstract))
SAMURA <sup>15</sup>		TCZ i.v. (n = 157)	N/A	Both groups – oral corticosteroids (10 mg of prednisolone per day) were allowed, but the dosage could not be increased during the study  Use of one NSAID, including switching to another NSAID, was allowed						
SATOR <sup>16</sup> (NCT00144521)	RCT (Phase III, double blind)	PBO + MTX (n = 64)	8 mg/week (maximum permitted dose in Japan)	Oral corticosteroids permitted at ≤ 10 mg/day of prednisolone (as worded) (dose increase not permitted)  Intra-articular corticosteroid injections (one joint maximum at one treatment) and hyaluronate preparations permitted  Use of one NSAID permitted (switching to another NSAID allowed)  DMARDs, i.v. or i.m. corticosteroids, plasmapheresis and surgical treatment not allowed	Double-blind controlled phase to week 24	ACR20 response at week 24	No	Single country, multicentre (25 sites across Japan)	Chugai Pharmaceutical, Japan	Nishimoto <i>et al.</i> , 2009 <sup>16</sup> full publication

continued

TABLE 338 Trial characteristics: populations 2 and 3 biologics vs. DMARD(s) or PBO (continued)

Trial name/study number (NCT/sponsor number)	Trial design (RCT, phase, LTE)	Treatment arms for which data extraction performed (number of patients randomised per treatment arm)	MTX dose during study (where applicable)	Concomitant treatments	Duration of RCT phase	Primary outcome	Early withdrawal plan reported?	Geographical location	Funding source	Primary and supplementary publication details (author, year, publication type (e.g. full, abstract))
SATOR <sup>116</sup>		TCZ 8 mg/kg i.v. every 4 weeks + PBO capsules (n = 61)								
TOWARD <sup>171</sup>	RCT (Phase III, double blind)	PBO i.v. every 4 weeks + stable cDMARDs (n = 415 randomised)	14.7 mg/week	Oral glucocorticoids ( $\leq 10$ mg/day of prednisone or equivalent) and NSAIDs/COX-2 inhibitors permitted if doses stable for $\geq 6$ weeks	24 weeks	ACR20 at week 24	Yes (early escape at week 16 for patients failing to achieve $> 20\%$ improvement in both swollen joint counts and tender joint counts consisting of adjustment of background DMARD dosage and/or a different DMARD and/or intra-articular/oral glucocorticoids)	Multinational (18 countries), multicentre	Roche	Genovese <i>et al.</i> , 2008 <sup>171</sup> full publication

Trial name/study (NCT/sponsor number)	Trial design (RCT, phase, LTE)	Treatment arms for which data extraction performed (number of patients randomised per treatment arm)	MTX dose during study (where applicable)	Concomitant treatments	Duration of RCT phase	Primary outcome	Early withdrawal plan reported?	Geographical location	Funding source	Primary and supplementary publication details (author, year, publication type (e.g. full, abstract))
TOWARD <sup>21</sup>		TCZ 8 mg/kg i.v. every 4 weeks + stable DIMARDS (n=805 randomised)	15.0 mg/week							
AiC information has been removed	AiC information has been removed	AiC information has been removed	AiC information has been removed	AiC information has been removed	AiC information has been removed	AiC information has been removed	AiC information has been removed	AiC information has been removed	AiC information has been removed	AiC information has been removed
AiC information has been removed		AiC information has been removed	AiC information has been removed	AiC information has been removed	AiC information has been removed					
<p>ADORE, Add Enbrel or Replace MTX; AIM, Abatacept in Inadequate responders to Methotrexate; ARMADA, Anti-TNF Research Study Program of the Monoclonal Antibody Adalimumab [D2E7] in Rheumatoid Arthritis; ASSET, Abatacept Systemic SclErosis Trial; ASSURE, Abatacept Study of Safety in Use with other RA Therapies; CHANGE, Clinical investigation in Highly disease-affected rheumatoid Arthritis patients in Japan with Adalimumab applying staNdar and General Evaluation study; COX-2, cyclooxygenase-2; CREATE IIb, A 6-month Randomised, Double-blind, Open Arm Comparator, Phase IIb, With AZD9056, in Patients With Rheumatoid Arthritis (RA); ETN309, Etanercept Study 309; ETN50, etanercept 50 mg once a week subcutaneously; i.m. intramuscular; IQR, interquartile range; MEASURE, secukinumab in ankylosing spondylitis; N/A, not applicable; NCT, clinicaltrials.gov reference number; NR, not reported; REALISTIC, RA Evaluation in Subjects receiving TNF Inhibitor Certolizumab pegol; SATORI, Study of Active controlled Tocilizumab for Rheumatoid arthritis patients with an Inadequate response to methotrexate; STAR, Safety Trial of Adalimumab in Rheumatoid arthritis; WHO, World Health Organization.</p> <p>ABT i.v. = BT ≈10 mg/kg intravenously on weeks 0, 2 and 4, and every 4 weeks thereafter.</p> <p>ABT s.c. = ABT 125 mg once per week subcutaneously, following an optional i.v. loading dose of ≈10 mg/kg based on weight range.</p> <p>ADA = ADA 40 mg every other week subcutaneously.</p> <p>CTZ = s.c. CTZ 400 mg at weeks 1, 2 and 4, then 200 mg every other week.</p> <p>ETN = ETN 25 mg twice a week subcutaneously.</p> <p>GOL = GOL 50 mg every 4 weeks subcutaneously.</p> <p>IFX = IFX 3 mg/kg intravenously at weeks 0, 2, 6 and every 8 weeks thereafter (with dose escalation permitted after week 12 if lack of response).</p> <p>TCZ = TCZ 8 mg/kg intravenously every 4 weeks.</p>										

TABLE 339 Trial characteristics: RCTs (ineligible for systematic review) used as additional evidence in NMA sensitivity analyses

Trial name/study (NCT/sponsor number)	Treatment arms for which data extraction performed (number of patients randomised per treatment arm)	MTX dose during study (where applicable)	Concomitant treatments	Duration of RCT phase	Primary outcome	Early withdrawal plan reported?	Geographical location	Funding source	Primary and supplementary publication details [author, year, publication type (e.g. full, abstract)]
ACQUIRE <sup>127</sup>	ABT s.c. + PBO i.v. + MTX (n = 736)	≥ 15 mg/week [mean at baseline 16.3 (SD 3.6) mg/week]	Corticosteroids (oral and/or injectable): 72.1%, mean (SD) dose 4.8 (4.5) mg/day	6 months	ACR20 (% patients achieving response) at 6 months	No	NR	Bristol-Myers Squibb	Genovese et al., 2011 <sup>127</sup> full-text paper
ACQUIRE <sup>127</sup>	ABT i.v. + PBO s.c. + MTX (n = 721)	≥ 15 mg/week [mean at baseline 16.5 (SD 3.8) mg/week]	Corticosteroids (oral and/or injectable): 74.6%, mean (SD) dose 5.2 (6.9) mg/day						
NCT00254293 <sup>131</sup>	PBO + MTX (n = 119 randomised)	10–30 mg/week, mean 15.8 (SD 4.1) mg/week	Addition of another DMARD (HCQ, SSZ, GLD, AZA) and/or adjustment in corticosteroids equivalent to ≤ 10 mg/day of prednisone were permitted. Use of the above not reported	12 months	ACR20 response at 6 months	No	Multicentre	Bristol-Myers Squibb	Kremer et al., 2005 <sup>131</sup> full-text paper Kremer et al., 2003 <sup>118</sup> full-text paper
NCT00254293 <sup>131</sup>	ABT i.v. (≈ 10 mg/kg) + MTX (n = 115 randomised)	10–30 mg/week, mean 15.0 (SD 4.4) mg/week							

Trial name/study (NCT/sponsor number)	Treatment arms for which data extraction performed (number of patients randomised per treatment arm)	MTX dose during study (where applicable)	Concomitant treatments	Duration of RCT phase	Primary outcome	Early withdrawal plan reported?	Geographical location	Funding source	Primary and supplementary publication details [author, year, publication type (e.g. full, abstract)]
ORAL STANDARD <sup>133</sup> (NCT00853385)	MTX + PBO (n = 108)	7.5–25 mg of MTX weekly, all groups applicable)	Glucocorticoids and lipid-lowering medication allowed	12 months	20% improvement at month 6 in ACR20; the change from baseline to month 3 in the score on the HAQ-DI (which ranges from 0 to 3, with higher scores indicating greater disability); and the percentage of patients at month 6 who had a DAS28 based on the ESR	Patients in the PBO group who did not have a 20% reduction in the number of swollen and tender joints after 3 months (considered as not having had a response) were randomly assigned to either 5 mg or 10 mg of TOF	Europe, USA, Korea, Latin America	Supported by Pfizer	van Vollenhoven <i>et al.</i> , 2012 <sup>133</sup> full-text article in peer-reviewed journal
ORAL STANDARD <sup>133</sup>	TOF5 + MTX (n = 204)								
ORAL STANDARD <sup>133</sup>	TOF10 + MTX (n = 201)								
ORAL STANDARD <sup>133</sup>	ADA + MTX (n = 204)								
JRAPID/Yamamoto <i>et al.</i> , 2011 <sup>129</sup> (NCT00791999)	PBO + MTX every 2 weeks (n = 77 patients randomised)	NR	MTX	24 weeks	ACR20 response at week 12	Early escape at week 16 for patients who failed to achieve ACR20 response at both weeks 12 and 14	Japan, multicentre	NR	Yamamoto <i>et al.</i> , 2011 <sup>129</sup> conference abstract
JRAPID <sup>129</sup>	CTZ 200 mg + MTX every 2 weeks (n = 82 patients randomised)	NR	MTX						

continued

TABLE 339 Trial characteristics: RCTs (ineligible for systematic review) used as additional evidence in MMA sensitivity analyses (continued)

Trial name/study (NCT/sponsor number)	Treatment arms for which data extraction performed (number of patients randomised per treatment arm)	MTX dose during study (where applicable)	Concomitant treatments	Duration of RCT phase	Primary outcome	Early withdrawal plan reported?	Geographical location	Funding source	Primary and supplementary publication details [author, year, publication type (e.g. full, abstract)]
RA0025 <sup>134</sup>	PBO + MTX (n = 40 randomised)	10–20 mg/week	MTX	24 weeks	ACR20 response at week 24	Patients with no ACR20 response at both weeks 12 and 14 were withdrawn	Korea	NR	Kang et al., 2012 <sup>134</sup> abstract
RA0025 <sup>134</sup>	CTZ 400 mg at weeks 0, 2 and 4 then 200 mg every 2 weeks + MTX (n = 81 randomised)	10–20 mg/week	MTX						
RAPID1 <sup>135</sup>	PBO + MTX (n = 199 randomised)	13.4 mg/week	MTX, oral corticosteroids ( $\leq 10$ mg/day of prednisone or equivalent with stable dose from 4 weeks prior to baseline), NSAIDs/COX-2 inhibitors and analgesics	52 weeks	ACR20 response rate at week 24 and mean change from baseline in modified total Sharp score at week 52	Early escape at week 16 for patients who failed to achieve ACR20 response at both weeks 12 and 14	NR	UCB	Keystone et al., 2008 <sup>135</sup> full-text paper
RAPID1 <sup>135</sup>	CTZ 400 mg at weeks 0, 2 and 4 then 200 mg every 2 weeks + MTX (n = 393 randomised)	13.6 mg/week							
RAPID2 <sup>136</sup>	PBO + MTX (n = 127 randomised)	12.2 mg/week	MTX	24 weeks	ACR20 response at week 24	Early escape at week 16 for patients who failed to achieve ACR20 response at both weeks 12 and 14	International	UCB	Smolen et al., 2009 <sup>136</sup> full-text paper

Trial name/study (NCT/sponsor number)	Treatment arms for which data extracted (number of patients randomised per treatment arm)	MTX dose during study (where applicable)	Concomitant treatments	Duration of RCT phase	Primary outcome	Early withdrawal plan reported?	Geographical location	Funding source	Primary and supplementary publication details (author, year, publication type (e.g. full, abstract))
RAPID2 <sup>136</sup>	CTZ 400 mg at weeks 0, 2 and 4 then 200 mg every 2 weeks + MTX (n = 246 randomised)	12.5 mg/week	MTX						
TEAR <sup>52</sup> (SA mixed population) (NCT00259610)	MTX monotherapy (ST) (n = 124) ST = step-up from MTX to triple DMARD therapy (MTX + SSZ plus HCQ)	MTX, which was escalated to a dosage of 20 mg/week or to a lower dosage if treatment resulted in no active tender/painful or swollen joints by week 12	For those receiving corticosteroids, the dosage (up to 10 mg/day of prednisone) had to be stable for at least 2 weeks prior to screening; for those receiving NSAIDs, the dosage had to be stable for at least 1 week prior to screening folic acid at a dosage of 1 mg per day	102 weeks	An observed-group analysis of DAS28-ESR values from week 48 to week 102	Step-up therapy part of study design	USA	Supported by Amgen through a grant to the University of Alabama at Birmingham, AL. The study drugs were provided by Amgen (ETN and PBO), Barr Pharmaceuticals (MTX) and Pharmacia (SZ and PBO). The initial phases of the study were supported by the National Institute for Health (planning grant 1-R34-AR-055122 from the National Institute of Arthritis and Musculoskeletal and Skin Diseases	Moreland <i>et al.</i> , 2012, <sup>53</sup> full-text article in peer-reviewed journal

continued

TABLE 339 Trial characteristics: RCTs (ineligible for systematic review) used as additional evidence in NMA sensitivity analyses (continued)

Trial name/study (NCT/sponsor number)	Treatment arms for which data extraction performed (number of patients randomised per treatment arm)	MTX dose during study (where applicable)	Concomitant treatments	Duration of RCT phase	Primary outcome	Early withdrawal plan reported?	Geographical location	Funding source	Primary and supplementary publication details [author, year, publication type (e.g. full, abstract)]
TEAR <sup>53</sup> (SA mixed population)	MTX monotherapy (SE) (n = 255) SU = step-up from MTX to MTX + ETN								
TEAR <sup>53</sup> (SA mixed population)	MTX + SSZ + HCQ (n = 132)								
TEAR <sup>53</sup> (SA mixed population)	ETN50 + MTX (n = 244)								
TEMPO <sup>54</sup>	MTX monotherapy (n = 228)	MTX dose [median 10 (IQR 7.5–15.0) mg/week]	NSAIDs and corticosteroids allowed 5-mg folic acid supplement twice a week	52 weeks	Numeric index of the ACR response area under the curve (AUC) over the first 24 weeks	NR	Europe, Australia, USA	Wyeth Research	Klaretskog et al., 2004 <sup>54</sup> full-text article in peer-reviewed journal
TEMPO <sup>54</sup>	ETN monotherapy (n = 223)	MTX dose [median 10 (IQR 7.5–13.8) mg/week]							
TEMPO <sup>54</sup>	ETN + MTX (n = 231)	MTX dose [median 10 (IQR 7.5–15.0) mg/week]							
AMBITION <sup>55</sup> (NCT00109408)	MTX alone (n = 284 randomised)	7.5–20 mg/week	Oral glucocorticoids ( $\leq 10$ mg/day of prednisone or equivalent) and NSAIDs permitted if dose stable for $\geq 6$ weeks	24 weeks	ACR20 at week 24	No	Multicentre, multinational	Roche	Jones et al., 2010 <sup>55</sup> full publication



Trial name/study (NCT/sponsor number)	Treatment arms for which data extraction performed (number of patients randomised per treatment arm)	MTX dose during study (where applicable)	Concomitant treatments	Duration of RCT phase	Primary outcome	Early withdrawal plan reported?	Geographical location	Funding source	Primary and supplementary publication details [author, year, publication type (e.g. full, abstract)]
AMBITION <sup>55</sup>	TCZ 8 mg/kg i.v. every 4 weeks (n = 288 randomised)	N/A							
LITHE <sup>30</sup> (NCT00106535)	PBO i.v. every 4 weeks + MTX (n = 393 randomised)	Patients received stable dose of MTX 10–25 mg/week Mean 15.0 (SD 4.2) mg/week	Oral corticosteroids ( $\leq 10$ mg/day prednisone or equivalent) and NSAIDs permitted if doses had been stable for $\geq 6$ weeks before study entry	52 weeks	Co-primary end points at week 52: change from baseline in total Genant-modified Sharp score and area under the curve for change from baseline in HAQ-DI	Yes Rescue therapy at week 16 for patients not achieving $\geq 20\%$ improvement in tender joint count and swollen joint count. PBO group received TCZ 4 mg/kg + steroids. TCZ 8 mg/kg group received TCZ 8 mg/kg + steroids. If $< 20\%$ improvement persisted after three doses of blinded first-step rescue therapy, patients received second-step rescue of TCZ 8 mg/kg. If still no response, treatment discontinued	Multicentre, multinational (14 countries)	Roche	Kremer <i>et al.</i> , 2011 <sup>30</sup> full publication
LITHE <sup>30</sup>	TCZ 8 mg/kg i.v. every 4 weeks + MTX (n = 398 randomised)	Mean 15.4 (SD 10.6) mg/week							

continued

TABLE 339 Trial characteristics: RCTs (ineligible for systematic review) used as additional evidence in MMA sensitivity analyses (continued)

Trial name/study (NCT/sponsor number)	Treatment arms for which data extraction performed (number of patients randomised per treatment arm)	MTX dose during study (where applicable)	Concomitant treatments	Duration of RCT phase	Primary outcome	Early withdrawal plan reported?	Geographical location	Funding source	Primary and supplementary publication details (author, year, publication type (e.g. full, abstract))
OPTION <sup>32</sup>	PBO i.v. every 4 weeks + MTX (n = 204 randomised)	14.8 (4.2) mg/week	Oral glucocorticoids ( $\leq 10$ mg/day of prednisone or equivalent) and NSAIDs permitted if doses stable for $\geq 6$ weeks before study entry	24 weeks	ACR20 at week 24	Yes	Multicentre (73 centres), multinational (17 countries)	Roche, Chugai Pharmaceutical	Smolen <i>et al.</i> , 2008 <sup>32</sup> full publication
OPTION <sup>32</sup>	TCZ 8 mg/kg i.v. every 4 weeks + MTX (n = 205 randomised)	14.5 (4.4) mg/week				Patients not achieving $\geq 20\%$ improvement in both swollen joint count and tender joint count by week 16 eligible for rescue therapy with TCZ 8 mg/kg and steroids if necessary or increase in oral corticosteroid dose (maximum 10 mg/day)			

ACQUIRE, subcutaneous abatacept versus intravenous abatacept; COX-2, cyclooxygenase 2; ETN50, etanercept 50 mg once a week subcutaneous; IQR, interquartile range; N/A, not applicable; NCT, clinicaltrials.gov reference number; NCT00254293, Study to Assess Steady-State Trough Concentrations, Safety, and Immunogenicity of Abatacept After Subcutaneous (SC) Administration to Subjects With Rheumatoid Arthritis (RA); NR, not reported; ORAL, Tofacitinib or Adalimumab versus Placebo in Rheumatoid Arthritis; SA, sensitivity analysis; TOF5, tofacitinib 5 mg; TOF10, tofacitinib 10 mg.

ABT i.v. = BT  $\approx 10$  mg/kg intravenously on weeks 0, 2 and 4, and every 4 weeks thereafter.

ABT s.c. = ABT 125 mg once per week subcutaneously, following an optional i.v. loading dose of  $\approx 10$  mg/kg based on weight range.

ADA = ADA 40 mg every other week subcutaneously.

CTZ = s.c. CTZ 400 mg at weeks 1, 2 and 4, then 200 mg every other week.

ETN = ETN 25 mg twice a week subcutaneously.

TCZ = TCZ 8 mg/kg intravenously every 4 weeks.

**TABLE 340** Population characteristics additional information: population 1 head-to-head trial

Trial name/study	Treatment arms for which data extraction performed	Ethnicity (where reported)	Rheumatoid factor (% positive)	Prior DMARD treatment history (brief description, including definition of active RA despite previous treatment, where relevant)	% receiving NSAIDs at baseline	% receiving steroids at baseline
Kume <i>et al.</i> , 2011 <sup>100</sup>	ADA monotherapy	NR	85.8	No prior treatment with MTX or biologics. Dosage of all DMARDs had to be stable for ≥ 8 weeks prior to enrolment	NR	NR
Kume <i>et al.</i> , 2011 <sup>100</sup>	ETN monotherapy	NR	88.6	No prior treatment with MTX or biologics. Dosage of all DMARDs had to be stable for ≥ 8 weeks prior to enrolment	NR	NR
NR, not reported. ADA = ADA 40 mg every other week subcutaneously. ETN = ETN 25 mg twice a week subcutaneously. IFX = IFX 3 mg/kg intravenously at weeks 0, 2, 6 and every 8 weeks thereafter (with dose escalation permitted after week 12 if lack of response).						

TABLE 341 Population characteristics additional information: population 1 biologic vs. DMARD(s) or PBO

Trial name/study	Treatment arms for which data extraction performed	Ethnicity (where reported)	Rheumatoid factor (% positive)	Prior DMARD treatment history (brief description, including definition of active RA despite previous treatment, where relevant)	% receiving NSAIDs at baseline	% receiving steroids at baseline
Bejarano <i>et al.</i> , 2008 <sup>77</sup>	PBO + MTX (n = 73)	NR	95	MTX naive; mean 0.2 prior cDMARDs	NR	NR
Bejarano <i>et al.</i> , 2008 <sup>77</sup>	ADA + MTX (n = 75)	NR	96	MTX naive; mean 0.2 prior cDMARDs	NR	NR
GUEPARD <sup>93</sup>	Initial MTX 12 weeks, then step-up therapy in both groups based on DAS28 (n = 32)	NR	77.4	MTX naive; no prior biologics	NR	31.3
GUEPARD <sup>93</sup>	Initial ADA + MTX 12 weeks, then step-up therapy in both groups based on DAS28 (n = 33)	NR	70.0	MTX naive; no prior biologics	NR	30.3
HIT HARD <sup>94</sup>	MTX + PBO	NR	69.4	Required to be DMARD naive, mean number of prior DMARDs was 0	NR	NR
HIT HARD <sup>94</sup>	ADA + PBO	NR	63.2	Required to be DMARD naive, mean number of prior DMARDs was 0	NR	NR
OPERA <sup>107</sup>	MTX + PBO + steroid	NR	74	Active RA by ACR (1987) revised criteria. Excluded if had glucocorticoids within the last 4 weeks or previous DMARD therapy	NR	NR
OPERA <sup>107</sup>	ADA + MTX + steroid	NR	70	Active RA by ACR (1987) revised criteria. Excluded if had glucocorticoids within the last 4 weeks or previous DMARD therapy	NR	NR
OPTIMA <sup>108</sup>	MTX + PBO	90% white	89	Patients were excluded if they had received prior MTX, more than two synthetic DMARDs or biologics	79	46
OPTIMA <sup>108</sup>	ADA + MTX	89% white	87	Patients were excluded if they had received prior MTX, more than two synthetic DMARDs or biologics	78	41

Trial name/study	Treatment arms for which data extraction performed	Ethnicity (where reported)	Rheumatoid factor (% positive)	Prior DMARD treatment history (brief description, including definition of active RA despite previous treatment, where relevant)	% receiving NSAIDs at baseline	% receiving steroids at baseline
PREMIER <sup>109</sup>	MTX + PBO	94.4% white	84.0	Required to be MTX naive (and no previous treatment with cyclophosphamide, CYC, AZA or more than two other DMARDs). 31.5% had prior DMARD experience	N/A	35.4
PREMIER <sup>109</sup>	ADA monotherapy + PBO step up week 16	93.5% white	83.5	Required to be MTX naive (and no previous treatment with cyclophosphamide, CYC, AZA or more than two other DMARDs). 33.2% had prior DMARD experience	N/A	36.5
PREMIER <sup>109</sup>	ADA + MTX step-up week 16	93.6% white	85.1	Required to be MTX naive (and no previous treatment with cyclophosphamide, CYC, AZA or more than two other DMARDs). 32.5% had prior DMARD experience	N/A	35.8
COMET <sup>81-83</sup>	MTX + PBO (n = 268)	White 88%	NR	MTX naive; % having prior cDMARDs = 24%	76	50
COMET <sup>81</sup>	ETN + MTX (n = 274)	White 87%	NR	MTX naive; % having prior cDMARDs = 18%	72	49
ERA/Bathon and Genovese, 2003 <sup>139</sup> (multicentre)	MTX + PBO	88% Caucasian	89	Required to be MTX naive. 46% of patients had prior DMARDs, mean number of DMARDs = 0.6 (SD 0.7)	80	41
ERA/Bathon and Genovese, 2003 <sup>139</sup> (multicentre)	ETN + PBO	86% Caucasian	87	Required to be MTX naive. 40% of patients had prior DMARDs, mean number of DMARDs = 0.5 (SD 0.7)	86	39

continued

TABLE 341 Population characteristics additional information: population 1 biologic vs. DMARD(s) or PBO (continued)

Trial name/study	Treatment arms for which data extraction performed	Ethnicity (where reported)	Rheumatoid factor (% positive)	Prior DMARD treatment history (brief description, including definition of active RA despite previous treatment, where relevant)	% receiving NSAIDs at baseline	% receiving steroids at baseline
GO-BEFORE <sup>90</sup>	PBO + MTX	White = 71.3%; black = 3.8%; Asian = 15.6%; other (no further details) = 9.4%	NR	MTX-naive patients. Patients had not received more than three weekly doses of oral MTX as RA treatment. Patients who had previously received IFX, ETN, ADA, RTX, natalizumab or cytotoxic agents excluded. Patients receiving anakinra could participate 4 weeks after receiving last dose. Patients receiving alefacept or efalizumab could participate 3 months after last dose	95.6	68.1
				Previous DMARDs = 83/160 (51.9%)		
				HCQ = 26/160 (16.3%)		
				SSZ = 51/160 (31.9)		
				LEF = 12/160 (7.5%)		
				Other DMARDs (no further details) = 26 (16.3%)		
				Anakinra = 0/0 (0.0%)		
				Immunosuppressive agents = 3/160 (1.9%)		
				Previous DMARDs = 80/159 (50.3%)	98.1	69.8
				HCQ = 33/159 (20.8%)		
				SSZ = 36/159 (22.6%)		
				LEF = 13/159 (8.2%)		
				Other DMARDs (no further details) = 29/159 (18.2%)		
				Anakinra = 0 (0.0%)		
				Immunosuppressive agents = 2/159 (1.3%)		
GO-BEFORE <sup>90</sup>	GOL + MTX	White = 74.8%; black = 0.6%; Asian = 18.9%; other (no further details) = 5.7%	NR			

Trial name/study	Treatment arms for which data extraction performed	Ethnicity (where reported)	Rheumatoid factor (% positive)	Prior DMARD treatment history (brief description, including definition of active RA despite previous treatment, where relevant)	% receiving NSAIDs at baseline	% receiving steroids at baseline
ASPIRE <sup>71</sup>	PBO + MTX	NR	71	Patients had persistent synovitis $\geq 3$ months and $\leq 3$ years, $\geq 10$ swollen joints, and $\geq 12$ tender joints  All patients were MTX naive. 65–71% were DMARD naive  Patients were excluded if any prior treatment with MTX (had to be three or fewer pre-study doses), had received other DMARDs within 4 weeks of entry (or LEF within past 6 months), or had been treated with IFX, ETN, ADA or other antiTNF agent	82	38
ASPIRE <sup>71</sup>	IFX i.v. 3 mg/kg at weeks 0, 2 and 6 and every 8 weeks thereafter + MTX	NR	71	65% DMARD naive 71% DMARD naive	85	37
BeST <sup>78</sup>	Sequential monotherapy (DAS steered)	NR	67	Patients had active disease with $\geq 6$ of 66 swollen joints, $\geq 6$ of 68 tender joints and ESR $\geq 28$ mm/hour or global health score of $\geq 20$ mm (0–100 VAS)  Exclusion criteria included previous treatment with DMARDs other than antimalarials. (HCQ and chloroquine = antimalarials)	NR	NR
BeST <sup>78</sup>	Step-up combination therapy (DAS steered)	NR	64	Previous antimalarial therapy = 7% Previous antimalarial therapy = 11%	NR	NR
BeST <sup>78</sup>	Initial combination therapy with prednisone (DAS steered)	NR	65	Previous antimalarial therapy = 8%	NR	NR
BeST <sup>78</sup>	Initial combination therapy with IFX (DAS steered)	NR	64	Previous antimalarial therapy = 9%	NR	NR

continued

TABLE 341 Population characteristics additional information: population 1 biologic vs. DMARD(s) or PBO (continued)

Trial name/study	Treatment arms for which data extraction performed	Ethnicity (where reported)	Rheumatoid factor (% positive)	Prior DMARD treatment history (brief description, including definition of active RA despite previous treatment, where relevant)	% receiving NSAIDs at baseline	% receiving steroids at baseline
Durez <i>et al.</i> , 2007 <sup>20</sup>	MTX	NR	64	MTX-naïve population. Patients had not been previously treated with MTX. Exclusion criteria included previous treatment with two or more DMARDs (no further details), MTX or i.v. MP	NR	NR
Durez <i>et al.</i> , 2007 <sup>20</sup>	MTX + i.v. MP	NR	100		NR	NR
Durez <i>et al.</i> , 2007 <sup>20</sup>	IFX 3 mg/kg i.v. at weeks 0, 2, 6, 14, 22, 30, 38, 46 + MTX	NR	67		NR	NR
IDEA <sup>95</sup>	MP 250 mg i.v. at week 0, PBO i.v. at weeks 2, 6, 14, 22 + MTX	NR	NR	Patients described as DMARD naïve (no further details)	NR	NR
IDEA <sup>95</sup>	IFX 3 mg/kg i.v. at weeks 0, 2, 6, 14, 22 + MTX (IFX dose modifications permitted according to DAS44 from week 26)	NR	NR		NR	NR
Quinn <i>et al.</i> , 2005 <sup>10</sup>	MTX + PBO	NR	60	No prior treatment with DMARDs or oral corticosteroids	NR	NR
Quinn <i>et al.</i> , 2005 <sup>10</sup>	IFX + MTX	NR	70	No prior treatment with DMARDs or oral corticosteroids	NR	NR

ASPIRE: Active controlled Study of Patients receiving Infliximab for the treatment of Rheumatoid arthritis of Early onset; DAS44, Disease Activity Score 44 joints; ERA, Early Rheumatoid Arthritis (etanercept); HIT HARD, High Induction Therapy with Anti-Rheumatic Drugs (adalimumab and methotrexate); IDEA, Remission induction comparing infliximab and high-dose intravenous steroid, followed by treat-to-target: a double-blind, randomised, controlled trial in new-onset, treatment-naïve, rheumatoid arthritis; N/A, not applicable; NR, not reported; OPTIMA, OPTimal protocol for treatment Initiation with Methotrexate and Adalimumab.  
 ADA = ADA 40 mg every other week subcutaneously.  
 ETN = ETN 25 mg twice a week subcutaneously.  
 GOL = GOL 50 mg every 4 weeks subcutaneously.  
 IFX = IFX 3 mg/kg intravenously at weeks 0, 2, 6 and every 8 weeks thereafter (with dose escalation permitted after week 12 if lack of response).



TABLE 342 Population characteristics additional information Population 2 Head to head trials

Trial name/study	Treatment arms for which data extraction performed	Ethnicity (where reported)	Rheumatoid factor (% positive)	Prior DMARD treatment history (brief description, including definition of active RA despite previous treatment, where relevant)	% receiving NSAIDs at baseline	% receiving steroids at baseline
ATTEST <sup>7a</sup>	PBO + MTX	76.4% Caucasian	77.3	MTX $\geq$ 15 mg/week for $\geq$ 3 months (stable for $\geq$ 28 days) and washed out all DMARDs (at least 28 days prior) except for MTX. No prior ABT or antiTNF therapy permitted	84.5	70.0
ATTEST <sup>7a</sup> (NCT00095147)	IFX 3 mg/kg i.v. administered on days 1 (i.e. week 0), 15 (i.e. week 2), 43 (i.e. week 6) and 85 (i.e. week 12) and every 56 days (i.e. 8 weeks) thereafter (NB: licensed dose 3 mg/kg i.v. at weeks 0, 2, 6 and every 8 weeks thereafter, adjustments in dosage and frequency of administration permitted after week 12 in license) + MTX	80.6% Caucasian	84.8	MTX = 110/110 (100%) Dose, mg/week = 16.6 (SD 3.7) Duration, months = 23.7 (SD 25.6) MTX = 164/165 (99.4%) Dose, mg/week = 16.3 (SD 3.6) Duration, months = 23.6 (SD 26.8)	86.1	71.5
ATTEST <sup>7a</sup> (NCT00095147)	ABT dosed according to weight: patients weighing < 60 kg, 60–100 kg, or > 100 kg received 500 mg, 750 mg or 1000 mg of ABT respectively. ABT administered i.v. on days 1, 15 and 29 and every 28 days thereafter, up to and including day 337 (156 randomised) + MTX	80.8% Caucasian	87.2	MTX = 156/156 (100%) Dose, mg/week = 16.5 (SD 3.7) Duration, months = 18.3 (SD 20.0)	85.3	75.6

continued

TABLE 342 Population characteristics additional information Population 2 Head to head trials (continued)

Trial name/study	Treatment arms for which data extraction performed	Ethnicity (where reported)	Rheumatoid factor (% positive)	Prior DMARD treatment history (brief description, including definition of active RA despite previous treatment, where relevant)	% receiving NSAIDs at baseline	% receiving steroids at baseline
AMPLE <sup>66</sup>	ABT s.c.	80.8% Caucasian	75.5	Inadequate response to MTX, no prior bDMARDs. Concomitant medication included SSZ (3.1%) and HCQ (13.2%)	NR	50.9
AMPLE <sup>66</sup>	ADA	78.0% Caucasian	77.4	Inadequate response to MTX, no prior bDMARDs. Concomitant medication included SSZ (3.4%) and HCQ (10.7%)	NR	50.3
RED-SEA <sup>114</sup>	ADA + cDMARDs (n = 60)	NR	91.7	100% prior MTX	58.3%	On oral prednisolone 33.3%
RED-SEA <sup>114</sup>	ETN50 + cDMARDs (n = 60)	NR	85	100% prior MTX	43.3%	On oral prednisolone 45%
ADACTA <sup>58</sup>	TCZ + PBO	NR	75	Patients with RA of at least 6 months duration and DAS28 > 5.1 who were MTX intolerant or for whom continued treatment with MTX was considered ineffective or inappropriate Mean number of previous DMARDs = 2.0 (SD 1.1) Stopped taking MTX < 2 months before baseline = 99/163 (61%)	NR	55
ADACTA <sup>58</sup>	ADA + PBO	NR	73	Mean number of previous DMARDs = 2.0 (SD 1.1) Stopped taking MTX < 2 months before baseline = 102/162 (63%)	NR	57

Trial name/study	Treatment arms for which data extraction performed	Ethnicity (where reported)	Rheumatoid factor (% positive)	Prior DMARD treatment history (brief description, including definition of active RA despite previous treatment, where relevant)	% receiving NSAIDs at baseline	% receiving steroids at baseline
deFilippis <i>et al.</i> , 2006 <sup>85</sup>	ETN + MTX	NR	NR	Non-responder to DMARDs for > 6 months (no further detail reported). All receiving a stable dose of concomitant MTX in 3 months before entering the study	NR	NR
deFilippis <i>et al.</i> , 2006 <sup>85</sup>	IFX + MTX	NR	NR	Non-responder to DMARDs for > 6 months (no further detail reported). All receiving a stable dose of concomitant MTX in 3 months before entering the study	NR	NR

NR, not reported.  
 ABT i.v. = BT ≈10 mg/kg intravenously on weeks 0, 2 and 4, and every 4 weeks thereafter.  
 ABT s.c. = ABT 125 mg once per week subcutaneously, following an optional i.v. loading dose of ≈10 mg/kg based on weight range.  
 ADA = ADA 40 mg every other week subcutaneously.  
 CTZ = s.c. CTZ 400 mg at weeks 1, 2 and 4, then 200 mg every other week.  
 ETN = ETN 25 mg twice a week subcutaneously.  
 IFX = IFX 3 mg/kg intravenously at weeks 0, 2, 6 and every 8 weeks thereafter (with dose escalation permitted after week 12 if lack of response).  
 TCZ = TCZ 8 mg/kg intravenously every 4 weeks.

TABLE 343 Population characteristics additional information: population 2 biologic vs. DMARD(s) or PBO

Trial name/study	Treatment arms for which data extraction performed	Ethnicity (where reported)	Rheumatoid factor (% positive)	Prior DMARD treatment history (brief description, including definition of active RA despite previous treatment, where relevant)	% receiving NSAIDs at baseline	% receiving steroids at baseline
AIM <sup>61,62</sup>	MTX + PBO n = 219	88.1% white	78.5	100% prior MTX; 8.7% prior cDMARDs other than MTX	82.6	68.5
AIM <sup>61</sup>	ABT i.v. + MTX (n = 433)	87.5% white	81.8	100% prior MTX; 12.2% prior cDMARDs other than MTX	85.5	72.1
ASSET <sup>72</sup>	PBO + MTX	82.6% Caucasian	82.6	Non-response to MTX ( $\geq$ 15 mg/week or a maximum tolerated dose of $\geq$ 10 mg/week for $\geq$ 3 months prior to day 1)	87.0	60.9
ASSET <sup>72</sup>	ABT i.v. ( $\approx$ 10 mg/kg) + MTX	96.3% Caucasian	55.6	Non-response to MTX ( $\geq$ 15 mg/week or a maximum tolerated dose of $\geq$ 10 mg/week for $\geq$ 3 months prior to day 1)	81.5	70.4
ASSURE <sup>73</sup>	PBO + cDMARDs	83.3% white	NR	Active disease (functional classes I, II, III, IV ACR) despite one or more biologic and/or NBT, stable dose for $\geq$ 28 days before trial (split analyses, only nonbiologic extracted)	NR	73.7 (concomitant)
ASSURE <sup>73</sup>	ABT + cDMARDs	83.9% white	NR	Active disease (functional classes I, II, III, IV ACR) despite one or more biologic and/or NBT, stable dose for $\geq$ 28 days before trial (split analyses, only nonbiologic extracted)	NR	71.6 (concomitant)
AUGUST II <sup>76</sup>	MTX + PBO (n = 76)		83	100% prior MTX	NR	59
AUGUST II <sup>76</sup>	ADA + MTX (n = 79)		81	100% prior MTX	NR	66
CHANGE <sup>80</sup>	PBO (n = 87)	NR	86.2	87.2% prior MTX (91.5% two or more DMARDs across all arms)	NR	NR
CHANGE <sup>80</sup>	ADA monotherapy (n = 91)	NR	90.8	87.2% prior MTX	NR	NR
DE019 <sup>84</sup>	MTX + PBO (n = 200)	83.0% white	89.5	100% prior MTX; mean 2.4 prior cDMARDs including MTX	NR	49.5
DE019 <sup>84</sup>	ADA + MTX (n = 207)	83.6% white	81.6	100% prior MTX; mean 2.4 prior cDMARDs including MTX	NR	Across two ADA arms, 44.9%
STAR <sup>117</sup>	PBO + cDMARDs (n = 318)	85.8% white	62.3	Mean 1.2 prior cDMARDs	63.8	54.4

Trial name/study	Treatment arms for which data extraction performed	Ethnicity (where reported)	Rheumatoid factor (% positive)	Prior DMARD treatment history (brief description, including definition of active RA despite previous treatment, where relevant)	% receiving NSAIDs at baseline	% receiving steroids at baseline
STAR <sup>117</sup>	ADA + cDMARDs (n = 318)	89.0% white	63.4	Mean 112 prior cDMARDs	62.3	50.9
Van De Putte <i>et al.</i> , 2004 <sup>122</sup>	PBO s.c.	NR	81.8	Previous treatment with at least one DMARD had failed, with patients having active RA defined as $\geq 12$ tender joints (0–68 scale), $\geq 10$ swollen joints (0–66 scale), and either ESR $\geq 28$ mm/first hour or CRP $\geq 20$ mg/l	83.6	67.3
				Patients excluded if had received investigational small molecule drug or biological agent within 2 months or 6 months before screening respectively		
				4-week washout period required for patients taking cDMARDs at time of recruitment		
Van De Putte <i>et al.</i> , 2004 <sup>122</sup>	ADA monotherapy	NR	79.6	Number of cDMARDs = 3.6 (SD 1.8)	82.3	68.1
ARMADA <sup>69,70</sup>	MTX + PBO (n = 62)	NR	Rheumatoid factor, IU/litre mean = 321.2 (SD 518.2)	100% prior MTX; mean 3.0 prior cDMARDs including MTX	NR	58.1
ARMADA <sup>69</sup>	ADA + MTX (n = 67)	NR	Rheumatoid factor, IU/litre mean = 269.3 (SD 390.0)	100% prior MTX; mean 2.9 prior cDMARDs including MTX	NR	Across all ADA dose arms, 46.4%
Kim <i>et al.</i> , 2007 <sup>99</sup>	MTX + PBO rescue week 18 (n = 65)	NR	82.5	100% prior MTX; 79.3% used two or three cDMARDs	NR	NR
Kim <i>et al.</i> , 2007 <sup>99</sup>	ADA + MTX (n = 63)	NR	76.9	100% prior MTX; 86.2% used two or three cDMARDs	NR	NR
CERTAIN <sup>79</sup>	PBO + cDMARDs	NR	67.3	Inclusion criteria of using cDMARD therapy for $\geq 6$ months (and < 10 years). No prior antiTNF use. (AIC information has been removed)	NR	NR

continued

TABLE 343 Population characteristics additional information: population 2 biologic vs. DMARD(s) or PBO (continued)

Trial name/study	Treatment arms for which data extraction performed	Ethnicity (where reported)	Rheumatoid factor (% positive)	Prior DMARD treatment history (brief description, including definition of active RA despite previous treatment, where relevant)	% receiving NSAIDs at baseline	% receiving steroids at baseline
CERTAIN <sup>79</sup>	CTZ 400 mg at weeks 0, 2 and 4 then 200 mg every 2 weeks + DMARDs	NR	74.0	Inclusion criteria of using cDMARD therapy for ≥ 6 months (and < 10 years). No prior antiTNF use. (AIC information has been removed)	NR	NR
REALISTIC <sup>113</sup>	PBO + existing cDMARDs	NR	NR overall trial population, 76.5	Inadequate response to one or more DMARDs. Post-hoc analysis of those with DAS28 > 5.1 at baseline, two or more prior cDMARDs and antiTNF naive	NR	NR
REALISTIC <sup>113</sup>	CTZ 400 mg at weeks 0, 2, 4 then 200 mg every 2 weeks + existing cDMARDs	NR	NR overall trial population, 73.9	Inadequate response to one or more DMARD. Post-hoc analysis of those with DAS28 > 5.1 at baseline, two or more prior cDMARDs and antiTNF naive	NR	NR
ADORE <sup>59,60</sup>	ETN monotherapy (n = 159)	White 158 (99.4%); black 0 (0%); Asian 1 (0.6%)	70.9	100% prior MTX; mean 2.2 other prior DMARDs	74.2	51.6
ADORE <sup>59</sup>	ETN + MTX (n = 155)	White 153 (98.7%); black 2 (1.3%); Asian 0 (0%)	69.5	100% prior MTX; mean 2.3 other prior DMARDs	81.3	56.8
CREATE IIb <sup>96</sup>	DMARD + PBO (n = 65)	NR	81.5	100% prior MTX or SSZ	NR	NR
CREATE IIb <sup>96</sup>	ETN50 + DMARD (n = 64)	NR	85.9	100% prior MTX or SSZ	NR	NR
ETN Study 309/Combe et al., 2006, <sup>88</sup> Combe et al., 2009 <sup>89</sup>	SSZ + PBO (n = 50)	NR	NR	100% prior SSZ; 58% prior cDMARDs other than SSZ	NR	40
ETN Study 309/Combe et al., 2006, <sup>88</sup> Combe et al., 2009 <sup>89</sup>	ETN + PBO (n = 103)	NR	NR	100% prior SSZ; 69.9% prior cDMARDs other than SSZ	NR	59.2
ETN Study 309/Combe et al., 2006, <sup>88</sup> Combe et al., 2009 <sup>89</sup>	ETN + SSZ (n = 101)	NR	NR	100% prior SSZ; 58.4% prior cDMARDs other than SSZ	NR	44.6

Trial name/study	Treatment arms for which data extraction performed	Ethnicity (where reported)	Rheumatoid factor (% positive)	Prior DMARD treatment history (brief description, including definition of active RA despite previous treatment, where relevant)	% receiving NSAIDs at baseline	% receiving steroids at baseline
JESMR <sup>140</sup>	ETN 25 mg every 2 weeks monotherapy	NR	91.5	Non-response to MTX (6–8 mg/week). No prior biologics	NR	46.4
JESMR <sup>140</sup>	ETN 25 mg every 2 weeks + MTX 6–8 mg/week	NR	86.7	Non-response to MTX (6–8 mg/week). No prior biologics	NR	60.3
Lan <i>et al.</i> , 2004 <sup>101</sup>	PBO + MTX (n = 29)	NR	NR	100% prior MTX	NR	NR
Lan <i>et al.</i> , 2004 <sup>101</sup>	ETN + MTX (n = 29)	NR	NR	100% prior MTX	NR	NR
LARA <sup>102</sup>	MTX + DMARD (n = 142)	White, 65 (45.8%) Mestizos, 34 (23.9%) African-Latin American, 23 (16.2%) Other, 20 (14.1%)	83.8	100% prior MTX	NR	NR
LARA <sup>102</sup>	ETN50 + MTX (n = 281)	White, 134 (47.7%) Mestizos, n (%) 60 (21.4%) African-Latin American, 39 (13.9%) Other, 48 (17.1%)	86.1	100% prior MTX	NR	NR
Moreland <i>et al.</i> , 1999 <sup>104</sup>	PBO (n = 80)	89% white	79	90% prior MTX; mean three prior cDMARDs including MTX	84	58
Moreland <i>et al.</i> , 1999 <sup>104</sup>	ETN + PBO (n = 78)	94% white	79	87% prior MTX; mean 3.3 prior cDMARDs including MTX	67	81
RACAT <sup>111</sup>	MTX + SSZ + HCQ (n = 178)	90.4% white	65.7	100% prior MTX	NR	47.2
RACAT <sup>111</sup>	ETN50 + MTX (n = 175)	83.4% white	67.2	100% prior MTX	NR	49.7

continued

TABLE 343 Population characteristics additional information: population 2 biologic vs. DMARD(s) or PBO (continued)

Trial name/study	Treatment arms for which data extraction performed	Ethnicity (where reported)	Rheumatoid factor (% positive)	Prior DMARD treatment history (brief description, including definition of active RA despite previous treatment, where relevant)	% receiving NSAIDs at baseline	% receiving steroids at baseline
Wajdula 2000 (reported in Chen <i>et al.</i> , 2006 <sup>123</sup> )	PBO (n = 111)			Mean 3.5 prior cDMARDs; failed to respond to at least one DMARD	85	71
Wajdula 2000 (reported in Chen <i>et al.</i> , 2006 <sup>123</sup> )	ETN (n = 105)			Mean 3.6 prior cDMARDs; failed to respond to at least one DMARD	86	70
Weinblatt <i>et al.</i> , 1999 <sup>124</sup>	MTX + PBO, (n = 30)	White 83%	90	100% prior MTX	80	70
Weinblatt <i>et al.</i> , 1999 <sup>124</sup>	ETN 25 mg twice weekly + MTX (n = 59)	White 76%	84	100% prior MTX	75	53
APPEAL <sup>67,68</sup>	MTX + DMARD (SSZ, HCQ or LEF) (n = 103)	NR	NR	100% prior MTX; 30.1% also other cDMARD(s)	NR	NR
APPEAL <sup>68</sup>	ETN 25 mg twice weekly (licensed dose) + MTX (n = 197)	NR	NR	100% prior MTX; 24.4% also other cDMARD(s)	NR	NR
GO-FORTH <sup>91</sup>	PBO every 4 weeks + MTX 6–8 mg/week	NR	NR	All patients had received MTX > 6 mg/week for ≥ 3 months prior to the start of the study. Other prior DMARDs and biologics not reported	NR	NR
GO-FORTH <sup>91</sup>	GOL 50 mg s.c. every 4 weeks + MTX 6–8 mg/week	NR	NR	All patients had received MTX > 6 mg/week for ≥ 3 months prior to the start of the study. Other prior DMARDs and biologics not reported	NR	NR



Trial name/study	Treatment arms for which data extraction performed	Ethnicity (where reported)	Rheumatoid factor (% positive)	Prior DMARD treatment history (brief description, including definition of active RA despite previous treatment, where relevant)	% receiving NSAIDs at baseline	% receiving steroids at baseline
GO-FORWARD <sup>92</sup>	PBO s.c. every 4 weeks + MTX	NR	81.2	<p>Patients had to have been on stable MTX dose of 15 mg/week or greater but 25 mg/week or less during the 4-week period immediately preceding screening. Must have tolerated at least 15 mg/week for at least 3 months before screening. Patients had active RA defined as <math>\geq 4</math> of 66 swollen joints, <math>\geq 4</math> of 68 tender joints and at least two of following criteria: CRP <math>\geq 1.5</math> mg/dl or ESR <math>\geq 28</math> mm/hour</p> <p>Median MTX dose (mg/week) = 15.0 (IQR 15.0–20.0)</p> <p>Duration of previous MTX use (years):</p> <ul style="list-style-type: none"> <li>&lt; 1 = 33 (24.8%)</li> <li><math>\geq 1</math> to &lt; 3 = 30 (22.6%)</li> <li><math>\geq 3</math> = 68 (51.1%)</li> </ul> <p>Patients with previous use of DMARD other than MTX = 94 (70.7%)</p> <p>(Any previous use of any antiTNF agent, RTX, natalizumab or cytotoxic agents excluded patients from trial participation. In addition, patients should not have taken anakinra; DMARDs other than MTX; or i.v., i.m. or intra-articular corticosteroids within 4 weeks before first dose of study drug or alefacept or efalizumab within 3 months of first dose of study drug)</p>	85.7	65.4

continued

TABLE 343 Population characteristics additional information: population 2 biologic vs. DMARD(s) or PBO (continued)

Trial name/study	Treatment arms for which data extraction performed	Ethnicity (where reported)	Rheumatoid factor (% positive)	Prior DMARD treatment history (brief description, including definition of active RA despite previous treatment, where relevant)	% receiving NSAIDs at baseline	% receiving steroids at baseline
GO-FORWARD <sup>92</sup>	GOL 50 mg s.c. every 4 weeks + MTX	NR	86.5 (77/89)	Median MTX dose (mg/week) = 15.0 (IQR 15.0–20.0)	86.5	75.3
				Duration of previous MTX use (years): < 1 = 20 (22.5%) ≥ 1 to < 3 = 32 (36.0%) ≥ 3 = 37 (41.6%)		
Kay et al., 2008 <sup>98</sup> (NCT00207714)	PBO s.c. + MTX	NR	NR	Patients with previous use of DMARD other than MTX = 70 (78.7%) All patients treated with MTX at dosage of at least 10 mg/week for ≥ 3 months and at stable dosage for ≥ 4 weeks before receiving first dose of study drug Patients had active RA defined as ≥ 6 swollen joints, ≥ 6 tender joints and at least two of the following three criteria: CRP ≥ 1.5 mg/dl, ESR ≥ 28 mm/hour or morning stiffness of ≥ 30 minutes	NR	NR
Kay et al., 2008 <sup>98</sup>	GOL 50 mg s.c. every 4 weeks + MTX	NR	NR		NR	NR

Trial name/study	Treatment arms for which data extraction performed	Ethnicity (where reported)	Rheumatoid factor (% positive)	Prior DMARD treatment history (brief description, including definition of active RA despite previous treatment, where relevant)	% receiving NSAIDs at baseline	% receiving steroids at baseline
Abe <i>et al.</i> , 2006 <sup>56</sup>	PBO + MTX	Japanese patients	NR	Eligible patients had received MTX treatment for more than 3 months, with a stable MTX dosage at 6 mg/week or more during the last 4 weeks  Patients had active RA defined as $\geq 6$ of 68 tender joints, $\geq 6$ of 66 swollen joints, and at least two of the following: morning stiffness $\geq 45$ minutes, ESR $\geq 28$ mm/hour, or CRP $\geq 2$ mg/dl. Patients not permitted to use DMARD, immunosuppressive drugs other than MTX, or intra-articular, i.m., i.v. or epidural corticosteroids	95.7	89.4
Abe <i>et al.</i> , 2006 <sup>56</sup>	IFX 3 mg/kg i.v. at weeks 0, 2 and 6 + MTX		NR		89.8	85.7
ATTRACT <sup>75</sup>	PBO i.v. + MTX	White 78/88 (89)	77	Patients had been receiving MTX for at least 3 months with no break in treatment of more than 2 weeks during that period. MTX dose required to have been stable at $\geq 12.5$ mg/week for at least 4 weeks before screening  Patients were excluded if they had used a DMARD other than MTX or received intra-articular/IM/IV corticosteroids in 4 weeks before screening; received any other agent to reduce TNF	72	64
ATTRACT <sup>75</sup>	IFX 3 mg/kg i.v. at weeks 0, 2 and 6 and every 8 weeks thereafter + MTX	White 80/86 (93%)	84	Mean number (SD) of previous DMARDs (excluding MTX) = 2.5 (1.4) Mean number of previous DMARDs (excluding MTX) = 2.8 (SD 1.5)	79	63

continued

TABLE 343 Population characteristics additional information: population 2 biologic vs. DMARD(s) or PBO (continued)

Trial name/study	Treatment arms for which data extraction performed	Ethnicity (where reported)	Rheumatoid factor (% positive)	Prior DMARD treatment history (brief description, including definition of active RA despite previous treatment, where relevant)	% receiving NSAIDs at baseline	% receiving steroids at baseline
Durez <i>et al.</i> , 2004 <sup>86</sup>	Single i.v. infusion of MP (sodium hemisuccinate) at week 0 + MTX	NR	87	Eligible patients had received 15 mg/week MTX treatment (10 mg when tolerance poor)  Previous treatment with i.v. MP pulse and/or anti-TNF agents excluded patients from participation	NR	NR
Durez <i>et al.</i> , 2004 <sup>86</sup>	IFX 3 mg/kg at weeks 0, 2 and 6 + MTX	NR	67	By randomisation, patients had received: MTX (100%), SSZ (85%), GLD salts (79%), HCQ (61%), CYC (58%), D-penicillamine (42%), AZA (30%) and LEF (18%) (authors stated no differences between i.v. MP and IFX arms, no data presented)	NR	NR
START <sup>18</sup>	PBO + MTX	NR	80.7	Previous DMARDs, median 3 (range 1–7)  Previous DMARDs, median 3 (range 2–6)	39.4	59
START <sup>18</sup>	IFX 3 mg/kg + MTX	NR	82.8	All patients had been receiving MTX for at least 6 months prior to randomisation and were permitted to receive stable doses of the following: chloroquine, AZA, penicillamine, oral/i.m. GLD, HCQ, SSZ, LEF, CYC, oral corticosteroids, NSAIDs. No prior biologics allowed  All patients had been receiving MTX for at least 6 months prior to randomisation and were permitted to receive stable doses of the following: chloroquine, AZA, penicillamine, oral/i.m. GLD, HCQ, SSZ, LEF, CYC, oral corticosteroids, NSAIDs. No prior biologics allowed	43.3	59.2

Trial name/study	Treatment arms for which data extraction performed	Ethnicity (where reported)	Rheumatoid factor (% positive)	Prior DMARD treatment history (brief description, including definition of active RA despite previous treatment, where relevant)	% receiving NSAIDs at baseline	% receiving steroids at baseline
Swefot <sup>119</sup>	SSZ (1000 mg twice daily orally) + HCQ (400 mg daily orally) + MTX	NR	65	Patients with early RA (with no previous treatment with DMARDs) were administered MTX (up to 20 mg/week). After 3–4 months, patients who had not achieved low disease activity (having DAS28 > 3), but were able to tolerate MRX were randomised to treatment arms	NR	8
Swefot <sup>119</sup>	IFX 3 mg/kg i.v. at weeks 0, 2, 6 and every 8 weeks thereafter + MTX	NR	69		NR	6
Wong <i>et al.</i> , 2009 <sup>25</sup>	PBO + MTX (with crossover to open-label IFX at week 24)	NR	7/8	Eligible patients had failed on two DMARDs including MTX. All patients had been receiving MTX ( $\leq 25$ mg/week)	NR	NR
Wong <i>et al.</i> , 2009 <sup>25</sup>	IFX 3 mg/kg at weeks 0, 2, 6 and 8 weeks thereafter + MTX	NR	7/16		NR	NR
Zhang <i>et al.</i> , 2006 <sup>126</sup>	PBO i.v. + MTX	Chinese patients	NR	Patients had been treated with MTX for at least 3 months at a stable dose (7.5–20 mg/week) for at least 4 weeks	NR	NR
Zhang <i>et al.</i> , 2006 <sup>126</sup>	IFX 3 mg/kg i.v. at weeks 0, 2, 6 and 14 + MTX		NR	Patients who began treatment with other DMARDs within 4 weeks before screening were ineligible. Treatment with other antiTNF agents within 3 months of study entry was not permitted	NR	NR
				64.0% had previously used drug other than MTX (no other details)		
				55.2% had previously used drug other than MTX (no other details)		

continued

TABLE 343 Population characteristics additional information: population 2 biologic vs. DMARD(s) or PBO (continued)

Trial name/study	Treatment arms for which data extraction performed	Ethnicity (where reported)	Rheumatoid factor (% positive)	Prior DMARD treatment history (brief description, including definition of active RA despite previous treatment, where relevant)	% receiving NSAIDs at baseline	% receiving steroids at baseline
ACT-RAY <sup>57</sup> (NCT00810199)	TCZ 8 mg/kg i.v. every 4 weeks + oral PBO (n = 277 randomised)	NR	NR	Subjects had been receiving MTX for at least 12 weeks with stable dose of at least 15 mg/week for at least 6 weeks before starting study treatment  Patients were excluded if had any previous use of biological agents as well as any cDMARD drug treatment other than MTX during the month (3 months for LEF) preceding baseline visit	NR	49.1
ACT-RAY <sup>57</sup>	TCZ 8 mg/kg i.v. every 4 weeks + MTX	NR	NR	Mean MTX dose, mg/week = 16.2 (SD 4.1)	NR	48.9
MEASURE <sup>103</sup>	PBO + MTX	NR	NR	Number of prior DMARDs (including MTX before study entry), mean = 1.9 (SD 1.0)	NR	NR
MEASURE <sup>103</sup>	TCZ 8 mg/kg i.v. every 4 weeks + MTX	NR	NR	Mean MTX dose, mg/week = 16.0 (SD 4.4)  Number of prior DMARDs (including MTX before study entry), mean = 1.9 (SD 1.1)  Patients were described as MTX inadequate responders	NR	NR

Trial name/study	Treatment arms for which data extraction performed	Ethnicity (where reported)	Rheumatoid factor (% positive)	Prior DMARD treatment history (brief description, including definition of active RA despite previous treatment, where relevant)	% receiving NSAIDs at baseline	% receiving steroids at baseline
Nishimoto <i>et al.</i> , 2004 <sup>106</sup>	PBO i.v. every 4 weeks	NR	NR	Eligible patients had been treated unsuccessfully (due to lack of efficacy) with one or more DMARD or immunosuppressant	NR	NR
Nishimoto <i>et al.</i> , 2004 <sup>106</sup>	TCZ 8 mg/kg i.v. every 4 weeks	NR	NR	Active RA defined as $\geq 6$ swollen joints, $\geq$ tender joints and one of the following two criteria: ESR $\geq 30$ mm/hour or CRP $> 1.0$ mg/dl		
SAMURAI <sup>115</sup>	cDMARDs disease activity (n = 145)	NR	NR	No DMARDs permitted during 4-week washout period before initiation of study agent and during study period		
SAMURAI <sup>115</sup>	TCZ i.v. (n = 157)	NR	NR	Number of failed DMARDs, median = 5 (range 1–10)		
SATORI <sup>116</sup>	PBO i.v. every 4 weeks + MTX	NR	NR	Number of failed DMARDs, median = 5 (range 1–11)	NR	NR
(NCT00144521)				67% prior MTX	NR	NR
				73% prior MTX	NR	NR
				Mean number of failed DMARDs = 3.6 (range 1–8)	NR	NR
				All candidates were treated with MTX 8 mg/week for at least 8 weeks until enrolment. Inadequate response to MTX defined as presence of active disease (as above)		
				Patients not permitted to receive prior anti-TNF agents or LEF (within 12 weeks prior to first dose). Patients not permitted to receive DMARDs other than MTX or immunosuppressants (within 2 weeks prior to first dose)		

continued

TABLE 343 Population characteristics additional information: population 2 biologic vs. DMARD(s) or PBO (continued)

Trial name/study	Treatment arms for which data extraction performed	Ethnicity (where reported)	Rheumatoid factor (% positive)	Prior DMARD treatment history (brief description, including definition of active RA despite previous treatment, where relevant)	% receiving NSAIDs at baseline	% receiving steroids at baseline
SATORI <sup>16</sup>	TCZ 8 mg/kg i.v. every 4 weeks + PBO capsule	NR	NR	Mean number of failed DMARDs = 3.3 (range 1–8)	NR	NR
TOWARD <sup>21</sup>	PBO i.v. every 4 weeks + stable cDMARDs	72% white; 10% Asian; 8% American Indian/ Native Alaskan; 7% black; 3% other	NR	Eligible patients had received stable doses of permitted DMARDs (MTX, chloroquine, HCQ, parenteral GLD, SSZ, AZA, and LEF) for ≥ 8 weeks before study entry  Patients unsuccessfully treated with an antiTNF agent or any cell-depleting therapy were excluded  Medication at baseline (%): MTX = 73.9 Chloroquine/HCQ = 19.8 SSZ = 14.3 LEF = 15.5 Parenteral GLD = 0.7 AZA = 2.2  Number of background DMARDs at baseline (%): One = 75 Two or more = 24 None = 1	77.1	54.6



Trial name/study	Treatment arms for which data extraction performed	Ethnicity (where reported)	Rheumatoid factor (% positive)	Prior DMARD treatment history (brief description, including definition of active RA despite previous treatment, where relevant)	% receiving NSAIDs at baseline	% receiving steroids at baseline
TOWARD <sup>121</sup>	TCZ 8 mg/kg i.v. every 4 weeks + stable DMARDs	72% white; 9% Asian; 10% American Indian/ Native Alaskan; 4% black; 3% other	NR	Medication at baseline (%): MTX = 75.8 Chloroquine/HCQ = 20.6 SSZ = 13.1 LEF = 12.1 Parenteral GLD = 0.2 AZA = 2.2 Number of background DMARDs at baseline (%): One = 77 Two or more = 22 None = 1	71.4	51.2

continued

TABLE 343 Population characteristics additional information: population 2 biologic vs. DMARD(s) or PBO (continued)

Trial name/study	Treatment arms for which data extraction performed	Ethnicity (where reported)	Rheumatoid factor (% positive)	Prior DMARD treatment history (brief description, including definition of active RA despite previous treatment, where relevant)	% receiving NSAIDs at baseline	% receiving steroids at baseline
TACIT <sup>141</sup>	Combination cDMARDs	AiC information has been removed	AiC information has been removed	AiC information has been removed	AiC information has been removed	AiC information has been removed
TACIT <sup>141</sup>	TNF inhibitor + DMARD	AiC information has been removed	AiC information has been removed	AiC information has been removed	AiC information has been removed	AiC information has been removed

AIM, Abatacept in Inadequate responders to Methotrexate; ASSET, Abatacept Systemic SclErosis Trial; ASSURE, Abatacept Study of Safety in Use with other RA Therapies; CHANGE, Clinical investigation in Highly disease-affected rheumatoid arthritis patients in Japan with Adalimumab applying standard and General Evaluation study; CREATE IIb, A 6-month Randomised, Double-blind, Open Arm Comparator, Phase IIb, With AZD9056, in Patients With Rheumatoid Arthritis (RA); ETN50, etanercept 50 mg once a week subcutaneously; i.m. intramuscular; IQR, interquartile range; MEASURE, secukinumab in ankylosing spondylitis; NR, not reported; REALISTIC, RA Evaluation in Subjects receiving TNF Inhibitor Certolizumab pegol; SATORI, Study of Active controlled Tocilizumab for Rheumatoid arthritis patients with an inadequate response to methotrexate; STAR, Safety Trial of Adalimumab in Rheumatoid arthritis.

ABT i.v. = BT ≈10 mg/kg intravenously on weeks 0, 2 and 4, and every 4 weeks thereafter.

ABT s.c. = ABT 125 mg once per week subcutaneously, following an optional i.v. loading dose of ≈10 mg/kg based on weight range.

ADA = ADA 40 mg every other week subcutaneously.

CTZ = s.c. CTZ 400 mg at weeks 1, 2 and 4, then 200 mg every other week.

ETN = ETN 25 mg twice a week subcutaneously.

GOL = GOL 50 mg every 4 weeks subcutaneously.

IFX = IFX 3 mg/kg intravenously at weeks 0, 2, 6 and every 8 weeks thereafter (with dose escalation permitted after week 12 if lack of response).

TCZ = TCZ 8 mg/kg intravenously every 4 weeks.

TABLE 344 Population characteristics: trials providing additional evidence for the NMA

Trial name/study	Treatment arms for which data extraction performed	Mean age (years, SD)	Sex (% female)	Early withdrawal plan reported?	Disease duration (years, SD)	Mean DAS28 at baseline (SD) (ESR or CRP where stated)
ACQUIRE <sup>127</sup>	ABT + PBO + MTX (n = 736)	49.9 (13.2)	84.4	NR	7.6 (8.1)	6.23 (0.85) CRP
ACQUIRE <sup>127</sup>	ABT + PBO + MTX (n = 721)	50.1 (12.6)	80.4		7.7 (7.8)	6.20 (0.8) DAS 28-CRP
NCT00254293 <sup>131</sup>	PBO + MTX (n = 119)	54.7 (NR), range 23–80	66	NR	8.9 (8.3)	5.5 (0.87) CRP
NCT00254293 <sup>131</sup>	ABT i.v. ( $\approx$ 10 mg/kg) + MTX (n = 115)	55.8 (NR), range 17–83	75		9.7 (9.8)	5.5 (0.6) CRP
ORAL STANDARD <sup>133</sup>	MTX + PBO (n = 108)	53.7	75.9	Yes	7.9	6.5 ESR; 5.5 CRP
ORAL STANDARD <sup>133</sup>	TOF5 + MTX (n = 204)	53.0	85.3		7.6	6.6 ESR; 5.4 CRP
ORAL STANDARD <sup>133</sup>	TOF10 + MTX (n = 201)	52.9	83.6		7.4	6.5 ESR; 5.4 CRP
ORAL STANDARD <sup>133</sup>	ADA + MTX (n = 204)	52.5	79.4		8.1	6.4 ESR; 5.3 CRP
JRAPID <sup>129</sup>	MTX + PBO (n = 77)	51.9 (11.1)	85.7	Yes	5.8 (4.1)	6.5 (0.9) ESR
JRAPID <sup>129</sup>	CTZ 200 mg every 2 weeks + MTX (n = 82)	50.6 (11.4)	84.1		5.6 (4.2)	6.2 (0.8) ESR
RA0025 <sup>134</sup>	PBO + MTX (n = 40)	51.6 (11.7)	88.9	Yes	6.5 (4.2)	7.33 (1.09) ESR
RA0025 <sup>134</sup>	CTZ + MTX (n = 81)	50.8 (11.1)	87.5		5.5 (4.6)	7.46 (1.29) ESR
RAPID1 <sup>135</sup>	PBO + MTX (n = 199)	52.2 (11.2)	83.9	Yes	6.2 (4.4)	7.0 (0.9) ESR
RAPID1 <sup>135</sup>	CTZ + MTX (n = 393)	51.4 (11.6)	82.4		6.1 (4.2)	6.9 (0.8) ESR
RAPID2 <sup>136</sup>	PBO + MTX (n = 127)	51.5 (11.8)	84.3	Yes	5.6 (3.9)	6.83 (0.87) ESR
RAPID2 <sup>136</sup>	CTZ + MTX (n = 246)	52.2 (11.1)	83.7		6.1 (4.1)	6.85 (0.84) ESR

continued

TABLE 344 Population characteristics: trials providing additional evidence for the NMA (continued)

Trial name/study	Treatment arms for which data extraction performed	Mean age (years, SD)	Sex (% female)	Early withdrawal plan reported?	Disease duration (years, SD)	Mean DAS28 at baseline (SD) (ESR or CRP where stated)
TEAR <sup>53</sup>	MTX monotherapy (ST) (n = 124)	49.3	70.2	Yes	0.38	5.8 ESR
	ST = step-up from MTX to triple DMARD therapy (MTX + SSZ + HCQ)					
TEAR <sup>53</sup>	MTX monotherapy (SE) (n = 255)	48.6	69		0.24	5.8 ESR
	SE = step-up from MTX to MTX + ETN					
TEAR <sup>53</sup>	MTX + SSZ + HCQ (n = 132)	48.8	76.5		0.34	5.8 ESR
TEAR <sup>53</sup>	ETN50 + MTX (n = 244)	50.7	74.2		0.29	5.8 ESR
TEMPO <sup>54</sup>	MTX monotherapy (n = 228)	53.0	79	NR	6.8 (5.5)	5.5 (1.2)
TEMPO <sup>54</sup>	ETN monotherapy (n = 223)	53.2	77		6.3 (5.1)	5.7 (1.1)
TEMPO <sup>54</sup>	ETN + MTX (n = 231)	52.5	74		6.8 (5.4)	5.5 (1.2)
AMBITION <sup>55</sup>	MTX (n = 284)	50.0 (12.9)	79	NR	6.2 (7.8)	6.8 (0.9)
(ITT baseline covariate data presented)	(Note that data are presented for the whole trial population as data for the MTX-experienced subgroup was not reported)					
AMBITION <sup>55</sup>	TCZ monotherapy (n = 288)	50.7 (13.1)	83		6.4 (7.9)	6.8 (1.0)
LITHE <sup>130</sup>	PBO + MTX (n = 393)	51.3 (12.4)	83	Yes	Mean = 9.0 (range 0.5–44.3)	6.5 (1.0)

Trial name/study	Treatment arms for which data extraction performed	Mean age (years, SD)	Sex (% female)	Early withdrawal plan reported?	Disease duration (years, SD)	Mean DAS28 at baseline (SD) (ESR or CRP where stated)
LITHE <sup>130</sup>	TCZ + MTX (n = 398)	53.4 (11.7)	82		Mean = 9.3 (range 0.6–48.8)	6.6 (1.0)
OPTION <sup>132</sup>	PBO + MTX (n = 204)	50.6 (12.1)	78	NR	7.8 (7.2)	6.8 (0.9)
OPTION <sup>132</sup>	TCZ + MTX (n = 205)	50.8 (11.8)	85		7.5 (7.3)	6.8 (0.9)

ACQUIRE, subcutaneous abatacept versus intravenous abatacept; ETN50, etanercept 50 mg once a week subcutaneously; ITT, intention to treat; NCT00254293, Study to Assess Steady-State Trough Concentrations, Safety, and Immunogenicity of Abatacept After Subcutaneous (SC) Administration to Subjects With Rheumatoid Arthritis (RA); NR, not reported; ORAL, Tofacitinib or Adalimumab versus Placebo in Rheumatoid Arthritis; TOF5, tofacitinib 5 mg; TOF10, tofacitinib 10 mg.

ABT i.v. = BT ≈10 mg/kg intravenously on weeks 0, 2 and 4, and every 4 weeks thereafter.

ABT s.c. = ABT 125 mg once per week subcutaneously, following an optional i.v. loading dose of ≈10 mg/kg based on weight range.

ADA = ADA 40 mg every other week subcutaneously.

CTZ = s.c. CTZ 400 mg at weeks 1, 2 and 4, then 200 mg every other week.

ETN = ETN 25 mg twice a week subcutaneously.

TCZ = TCZ 8 mg/kg intravenously every 4 weeks.

Data are shown to the level of accuracy available in the source material.

TABLE 345 Population characteristics additional information: NMA sensitivity analyses trials

Trial name/ author, year	Treatment arms for which data extraction performed	Ethnicity (where reported)	Rheumatoid factor (% positive)	Prior DMARD treatment history (brief description, including definition of active RA despite previous treatment, where relevant)	n (%) receiving NSAIDs at baseline	n (%) receiving steroids at baseline
ACQUIRE <sup>127</sup>	ABT s.c. + PBO i.v. + MTX	74.7% Caucasian	84.8	Inadequate response to $\geq 3$ months of MTX at $\geq 15$ mg/week. Prior biologics in 4.3% of the sample	NR	NR
ACQUIRE <sup>127</sup>	ABT i.v. + PBO s.c. + MTX	74.5% Caucasian	85.9	Inadequate response to $\geq 3$ months of MTX at $\geq 15$ mg/week. Prior biologics in 6.0% of the sample	NR	NR
NCT00254293 <sup>131</sup>	PBO + MTX	87% white	NR	99.2% prior MTX, 21.0% other prior DMARDs, 2.6% prior antiTNF	NR	67.2
NCT00254293 <sup>131</sup>	ABT i.v. ( $\approx 10$ mg/kg) + MTX	87% white	NR	99.1% prior MTX, 16.5% other prior DMARDs, 2.6% prior antiTNF	NR	60.0
ORAL STANDARD <sup>133</sup>	MTX + PBO	Region of origin: North America 28.7%; Latin America 4.7%; Europe 49%; other 18.5%	66.3	100% prior MTX, 54.7% other prior cDMARDs, 8.3% prior TNF inhibitor	NR	66.7
ORAL STANDARD <sup>133</sup>	TOF5 + MTX	Region of origin: North America 24.5%; Latin America 3.9; Europe 53.9%; other 17.6%	66.8	100% prior MTX, 53.4% other prior cDMARDs, 5.9% prior TNF inhibitor	NR	61.8
ORAL STANDARD <sup>133</sup>	TOF10 + MTX	Region of origin: North America 24.9%; Latin America 1.5%; Europe 55.7%; other 17.9%	66.2	100% prior MTX, 57.2% other prior cDMARDs, 7.0% prior TNF inhibitor	NR	64.2
ORAL STANDARD <sup>133</sup>	ADA + MTX	Region of origin: North America 25.5%; Latin America 2.9%; Europe 53.9%; other 17.6%	68.2	100% prior MTX, 55.9% other prior cDMARDs, 7.8% prior TNF inhibitor	NR	61.3
JRAPID/Yamamoto et al., 2011 <sup>129</sup>	MTX + PBO	NR	85.7	Inadequate response to MTX. 19.5% had prior TNF inhibitors	NR	NR
(NCT00791999)						
JRAPID <sup>129</sup>	CTZ 200 mg every 2 weeks + MTX	NR	86.6	Inadequate response to MTX. 13.4% had prior TNF inhibitors	NR	NR

Trial name/ author, year	Treatment arms for which data extraction performed	Ethnicity (where reported)	Rheumatoid factor (% positive)	Prior DMARD treatment history (brief description, including definition of active RA despite previous treatment, where relevant)	n (%) receiving NSAIDs at baseline	n (%) receiving steroids at baseline
RA0025 <sup>134</sup>	PBO + MTX	NR	NR	Inadequate response to MTX. Study MTX dose 10–20 mg (min.–max.). Prior TNF inhibitors in 13.6%	NR	NR
RA0025 <sup>134</sup>	CTZ 400 mg at weeks 0, 2 and 4 then 200 mg every 2 weeks + MTX	NR	NR	Inadequate response to MTX. Study MTX dose 10–20 mg (min.–max.). Prior TNF inhibitors in 17.5%	NR	NR
RAPID1 <sup>135</sup>	PBO + MTX	NR	82.8	Patients were required to receive MTX for ≥ 6 months with a stable dosage of ≥ 10 mg/week for ≥ 2 months prior to baseline. No biologics within 6 months of baseline (or within 3 months for ETN/AKR) and/or no previous biologics that resulted in severe hypersensitivity or anaphylactic reaction, or response failure to anti-TNF agent. Mean (SD) of 1.4 (one previous DMARD). Prior TNF inhibitors in 3.5%	NR	NR
RAPID1 <sup>135</sup>	CTZ 400 mg at weeks 0, 2 and 4 then 200 mg every 2 weeks + MTX	NR	79.6	Patients were required to receive MTX for ≥ 6 months with a stable dosage of ≥ 10 mg/week for ≥ 2 months prior to baseline. No biologics within 6 months of baseline (or within 3 months for ETN/ANA) and/or no previous biologics that resulted in severe hypersensitivity or anaphylactic reaction, or response failure to anti-TNF agent. Mean (SD) of 1.3 (one previous DMARD). Prior TNF inhibitors in 2.8%	NR	NR

continued

TABLE 345 Population characteristics additional information: NMA sensitivity analyses trials (continued)

Trial name/ author, year	Treatment arms for which data extraction performed	Ethnicity (where reported)	Rheumatoid factor (% positive)	Prior DMARD treatment history (brief description, including definition of active RA despite previous treatment, where relevant)	n (%) receiving NSAIDs at baseline	n (%) receiving steroids at baseline
RAPID2 <sup>136</sup>	PBO + MTX	NR	78.2	Patients were required to receive MTX for $\geq 6$ months with a stable dosage of $\geq 10$ mg/week for $\geq 2$ months prior to baseline. No biologics within 6 months of baseline (or within 3 months for ETN/ANA) and/or no previous biologics that resulted in severe hypersensitivity or anaphylactic reaction, or response failure to antiTNF agent. Mean (SD) of 1.2 (one previous DMARD excluding MTX). Prior antiTNF use in 1.6% patients	NR	59.8
RAPID2 <sup>136</sup>	CTZ 400 mg at weeks 0, 2 and 4 then 200 mg every 2 weeks + MTX	NR	77.5	Patients were required to receive MTX for $\geq 6$ months with a stable dosage of $\geq 10$ mg/week for $\geq 2$ months prior to baseline. No biologics within 6 months of baseline (or within 3 months for ETN/ANA) and/or no previous biologics that resulted in severe hypersensitivity or anaphylactic reaction, or response failure to antiTNF agent. Mean (SD) of 1.2 (one previous DMARD excluding MTX). Prior antiTNF use in 1.6% patients	NR	55.3
TEAR <sup>53</sup>	MTX monotherapy (ST) (n = 124)  ST = step-up from MTX to triple DMARD therapy (MTX + SSZ + HCQ)  MTX monotherapy (SE) (n = 255)  SE = step-up from MTX to MTX + ETN	White 85.5%; African American 11.3%; Hispanic 8.1%	87.1	14.5% prior MTX, 0% prior biologics	NR	33.1
TEAR <sup>53</sup>		White 78.4%; African American 11.4%; Hispanic 12.6%	91	20% prior MTX, 0.8% prior biologics	NR	43.5



Trial name/ author, year	Treatment arms for which data extraction performed	Ethnicity (where reported)	Rheumatoid factor (% positive)	Prior DMARD treatment history (brief description, including definition of active RA despite previous treatment, where relevant)	n (%) receiving NSAIDs at baseline	n (%) receiving steroids at baseline
TEAR <sup>53</sup>	MTX + SSZ + HCQ (n = 132)	White 81.1%; African American 8.3%; Hispanic 12.9%	91.7	20.5% prior MTX, 0% prior biologics	NR	43.9
TEAR <sup>53</sup>	ETN50 + MTX (n = 244)	White 77.1%; African American 12.7%; Hispanic 10.7%	88.5	24.6% prior MTX, 0.8% prior biologics	NR	43.0
TEMPO <sup>54</sup>	MTX monotherapy (n = 228)	NR	71	42% prior MTX, mean 2.3 prior cDMARDs including MTX	86	64
TEMPO <sup>54</sup>	ETN monotherapy (n = 223)	NR	75	42% prior MTX, mean 2.3 prior cDMARDs including MTX	88	57
TEMPO <sup>54</sup>	ETN + MTX (n = 231)	NR	76	44% prior MTX, mean 2.3 prior cDMARDs including MTX	88	62
AMBITION <sup>55</sup> (ITT baseline covariate data presented)	MTX alone	NR	NR	Patients excluded if they had been unsuccessfully treated with an antiTNF agent, had received MTX in the 6 months before randomisation or discontinued MTX due to clinically important adverse effects or lack of efficacy. Patients who had temporarily discontinued MTX owing to side effects or desire to become pregnant and those who discontinued antiTNF agents for reasons other than efficacy (e.g. treatment cost, side effects) could participate in study	NR	47
				Patients had active RA defined as $\geq 6$ of 66 swollen joints, $\geq 8$ of 68 tender joints and CRP $\geq 1$ mg/dl or ESR $\geq 28$ mm/hour		
				MTX naive = 67%		
				Number previous DMARDs/antiTNF agents, mean = 1.1 (SD 1.4)		
				Previous use of antiTNF agents = 7.4% (per-protocol)		

continued

TABLE 345 Population characteristics additional information: NMA sensitivity analyses trials (continued)

Trial name/ author, year	Treatment arms for which data extraction performed	Ethnicity (where reported)	Rheumatoid factor (% positive)	Prior DMARD treatment history (brief description, including definition of active RA despite previous treatment, where relevant)	n (%) receiving NSAIDs at baseline	n (%) receiving steroids at baseline
AMBITION <sup>55</sup>	TCZ 8 mg/kg i.v. every 4 weeks	NR	NR	MTX naive = 67%	NR	48
LITHE <sup>130</sup>	PBO i.v. every 4 weeks + MTX	NR	82	Number previous DMARDs/antiTNF agents, mean = 1.2 (SD 1.3)  Previous use of antiTNF agents = 8.3% (per protocol)  Eligible patients who had inadequate responses to MTX [despite receiving MTX for ≥ 12 weeks before baseline (stable dose of 10–25 mg/week for ≥ 8 weeks)], with active RA defined as ≥ 6 swollen joints, ≥ 8 tender joints, and either CRP ≥ 1 mg/dl or ESR ≥ 28 mm/hour, and had ≥ radiographically confirmed joint erosion  All other DMARDs or biological agents were discontinued before study entry (LEF for ≥ 12 weeks, IFX or ADA for ≥ 8 weeks and ETN for ≥ 2 weeks)  Additional exclusion criteria: failure to respond to antiTNF treatment  Number of previous DMARDs/antiTNFs, mean = 1.6 (SD 1.5)  % with past use of DMARDs = 71.2%  % with past use of antiTNF agents = 11.5%	NR	70

Trial name/ author, year	Treatment arms for which data extraction performed	Ethnicity (where reported)	Rheumatoid factor (% positive)	Prior DMARD treatment history (brief description, including definition of active RA despite previous treatment, where relevant)	n (%) receiving NSAIDs at baseline	n (%) receiving steroids at baseline
LITHE <sup>130</sup>	TCZ 8 mg/kg i.v. every 4 weeks + MTX	NR	83	Number of previous DMARDs/antiTNFs, mean = 1.6 (SD 1.4)  % with past use of DMARDs = 75.4%  % with past use of antiTNF agents = 10.8%	NR	62
OPTION <sup>132</sup>	PBO i.v. every 4 weeks + MTX	NR	71	Eligible patients had experienced an inadequate response to MTX, with active RA defined as $\geq 6$ swollen joints, $\geq 8$ tender joints and CRP $\geq 10$ mg/l or ESR $\geq 28$ mm/hour. Patients had received MTX for $\geq 12$ weeks before study entry (with a stable dose of 10–25 mg/week for $\geq 8$ weeks)  All other DMARDs were discontinued prior to study entry (LEF for $\geq 12$ weeks, AKR for $\geq 1$ week, ETN for $\geq 2$ weeks, and IFX or ADA for $\geq 8$ weeks)  Patients excluded if they had previous unsuccessful antiTNF treatment (discontinuations owing to cost or injection discomfort not excluded)	68	54
				Number of previous DMARDs (not including MTX) = 1.7 (SD 1.5)		
				Previous antiTNF treatment = 19/204 (9%)		

continued

TABLE 345 Population characteristics additional information: NMA sensitivity analyses trials (continued)

Trial name/ author, year	Treatment arms for which data extraction performed	Ethnicity (where reported)	Rheumatoid factor (% positive)	Prior DMARD treatment history (brief description, including definition of active RA despite previous treatment, where relevant)	n (%) receiving NSAIDs at baseline	n (%) receiving steroids at baseline
OPTION <sup>132</sup>	TCZ 8 mg/kg i.v. every 4 weeks + MTX	NR	83	Number of previous DMARDs (not including MTX) = 1.5 (SD 1.4)	66	55
Previous antiTNF treatment = 1/205 (5%)						
<p>ACQUIRE, subcutaneous abatacept versus intravenous abatacept; AKR, anakinra; ANA, antinuclear antibody; ETN50, etanercept 50 mg once a week subcutaneously; ITT, intention to treat; max., maximum; min., minimum; NCT00254293, Study to Assess Steady-State Trough Concentrations, Safety, and Immunogenicity of Abatacept After Subcutaneous (SC) Administration to Subjects With Rheumatoid Arthritis (RA); NR, not reported; ORAL, Tofacitinib or Adalimumab versus Placebo in Rheumatoid Arthritis; TOF5, tofacitinib 5 mg; TOF10, tofacitinib 10 mg.</p> <p>ABT i.v. = BT ≈10 mg/kg intravenously on weeks 0, 2 and 4, and every 4 weeks thereafter.</p> <p>ABT s.c. = ABT 125 mg once per week subcutaneously, following an optional i.v. loading dose of ≈10 mg/kg based on weight range.</p> <p>ADA = ADA 40 mg every other week subcutaneously.</p> <p>CTZ = s.c. CTZ 400 mg at weeks 1, 2 and 4, then 200 mg every other week.</p> <p>ETN = ETN 25 mg twice a week subcutaneously.</p> <p>IFX = IFX 3 mg/kg intravenously at weeks 0, 2, 6 and every 8 weeks thereafter (with dose escalation permitted after week 12 if lack of response).</p> <p>TCZ = TCZ 8 mg/kg intravenously every 4 weeks.</p> <p>Data are shown to the level of accuracy available in the source material.</p>						

TABLE 346 Disease Activity Score: population 1 head-to-head trial

Study	Treatment arms for which data extraction performed	Assessment time point	DAS28-ESR or DAS28-CRP where stated	n analysed	Mean DAS28 at baseline (SD)	DAS28 mean change from baseline (SD)
Kume <i>et al.</i> , 2011 <sup>100</sup>	ADA monotherapy	24 weeks	DAS28-ESR	19	5.34 (1.4) (n = 21)	-2.12 (0.38)
Kume <i>et al.</i> , 2011 <sup>100</sup>	ETN monotherapy	24 weeks	DAS28-ESR	20	5.17 (1.5) (n = 21)	-2.84 (0.42)
ADA = ADA 40 mg every other week subcutaneously. ETN = ETN 25 mg twice a week subcutaneously.						

TABLE 347 Disease Activity Score: population 1 biologics vs. DMARD(s) or PBO

Trial name/ study	Treatment arms for which data extraction performed	Assessment time point	DAS28-ESR or DAS28-CRP where stated	<i>n</i> analysed	Mean DAS28 at baseline (SD)	Mean DAS28 at follow-up (SD)	DAS28 mean change from baseline (SD)	% achieving DAS28 remission (defined threshold)
GUEPARD <sup>93</sup>	Initial MTX	Week 12	NR	32	DAS28 (ESR) 6.15 (0.88)	NR	NR	DAS < 2.6, 12.5%
GUEPARD <sup>93</sup>	Initial ADA + MTX	Week 12	NR	33	DAS28 (CRP) 5.85 (0.9) DAS28 (ESR) 6.31 (0.78)	NR	NR	DAS < 2.6, 36.4%
GUEPARD <sup>93</sup>	Initial MTX	Week 52	NR	32	DAS28 (CRP) 5.80 (0.8) NR	NR	NR	DAS < 2.6, 59.4%
GUEPARD <sup>93</sup>	12 weeks, then step-up therapy in both groups based on DAS28 Initial ADA + MTX	Week 52	NR	33	NR	NR	NR	DAS < 2.6, 39.4%
HIT HARD <sup>94,173</sup>	12 weeks, then step-up therapy in both groups based on DAS28 MTX + PBO	24 weeks (study RCT end point)	DAS28-ESR	85	6.3 (0.9)	3.6 (1.4)	-2.7 (NR)	29.5 (< 2.6)
HIT HARD <sup>94</sup>	ADA + MTX	24 weeks (study RCT end point)	DAS28-ESR	87	6.2 (0.8)	3.0 (1.2) <sup>a</sup>	-3.2 (NR)	47.9 <sup>a</sup> (< 2.6)
OPERA <sup>107</sup>	MTX + PBO + steroid	12 months (primary end point and study RCT end point)	DAS28-CRP	91	5.6 (3.8, 7.0) <sup>b</sup>	2.6 (1.7, 4.7) <sup>b</sup>	-3.0 (NR)	49 (< 2.6)
OPERA <sup>107</sup>	ADA + MTX + steroid	12 months (primary end point and study RCT end point)	DAS28-CRP	89	5.5 (3.8, 7.8) <sup>b</sup>	2.0 (1.7, 5.0) <sup>a,b</sup>	-3.5 (NR)	74 <sup>c</sup> (< 2.6)
OPTIMA <sup>108</sup>	MTX + PBO	26 weeks (study RCT end point)	DAS28-CRP	517	6.0 (1.0)	4.1 (n = 505)	-1.9 (NR)	17 (< 2.6)

continued

TABLE 347 Disease Activity Score: population 1 biologics vs. DMARD(s) or PBO (continued)

Trial name/ study	Treatment arms for which data extraction performed	Assessment time point	DAS28-ESR or DAS28-CRP where stated	n analysed	Mean DAS28 at baseline (SD)	Mean DAS28 at follow-up (SD)	DAS28 mean change from baseline (SD)	% achieving DAS28 remission (defined threshold)
OPTIMA <sup>108</sup>	ADA + MTX	26 weeks (study RCT end point)	DAS28-CRP	515	6.0 (1.0)	3.3 <sup>a</sup> (n = 499)	-2.7 (NR)	34 (<2.6) <sup>c</sup>
PREMIER <sup>109</sup>	MTX + PBO	1 year (primary end point)	NR	257	6.3 (0.9)	NR	NR	21 (<2.6)
PREMIER <sup>109</sup>	ADA monotherapy + PBO step-up week 16	1 year (primary end point)	NR	274	6.4 (0.9)	NR	NR	23 (<2.6)
PREMIER <sup>109</sup>	ADA + MTX step-up week 16	1 year (primary end point)	NR	268	6.3 (0.9)	NR	NR	43 (<2.6) <sup>c</sup> (vs. MTX vs. ADA)
PREMIER <sup>109</sup>	MTX + PBO	2 years (study RCT end point)	NR	257	6.3 (0.9)	NR	NR	25 (<2.6)
PREMIER <sup>109</sup>	ADA monotherapy + PBO step-up week 16	2 years (study RCT end point)	NR	274	6.4 (0.9)	NR	NR	25 (<2.6)
PREMIER <sup>109</sup>	ADA + MTX step-up week 16	2 years (study RCT end point)	NR	268	6.3 (0.9)	NR	NR	49 (<2.6) <sup>c</sup> (vs. MTX vs. ADA)
COMET <sup>81</sup>	MTX + PBO (n = 268)	52 weeks	NR	263	6.5 (1.0)	NR	NR	DAS28 < 2.6, 28%
COMET <sup>81</sup>	ETN + MTX (n = 274)	52 weeks	NR	265	6.5 (1.0)	NR	NR	DAS28 < 2.6, 50% <sup>c</sup>
COMET <sup>82</sup>	MTX in year 1, MTX in year 2 n = 99 at start of period 2	2 years	NR	130	NR	NR	NR	22%
COMET <sup>81</sup>	MTX in year 1, ETN + MTX in year 2 n = 90 at start of period 2	2 years	NR	133	NR	NR	NR	36% <sup>a</sup> vs. group given MTX both years
COMET <sup>81</sup>	ETN + MTX in year 1, ETN + MTX in year 2 n = 111 at start of period 2	2 years	NR	131	NR	NR	NR	45% <sup>c</sup> vs. group given MTX both years
COMET <sup>81</sup>	ETN + MTX in year 1, ETN in year 2 n = 111 at start of period 2	2 years	NR	134	NR	NR	NR	37% <sup>a</sup> vs. group given MTX both years

Trial name/ study	Treatment arms for which data extraction performed	Assessment time point	DAS28-ESR or DAS28-CRP where stated	<i>n</i> analysed	Mean DAS28 at baseline (SD)	Mean DAS28 at follow-up (SD)	DAS28 mean change from baseline (SD)	% achieving DAS28 remission (defined threshold)
GO-BEFORE <sup>90</sup>	PBO + MTX	24 weeks	DAS28-ESR	160	DAS28-ESR 6.2 (1.17)	NR	NR	DAS28-ESR 11
GO-BEFORE <sup>90</sup>	GOL 50 mg s.c. every 4 weeks + MTX	24 weeks		159	DAS28-ESR 6.3 (1.1)	NR	NR	25 <sup>c</sup>
GO-BEFORE <sup>143</sup>	PBO + MTX	52 weeks	DAS28-CRP	160	DAS28-ESR 6.2 (1.17)	NR	NR	38.8
GO-BEFORE <sup>90</sup>	GOL 50 mg s.c. every 4 weeks + MTX	52 weeks		159	DAS28-ESR 6.3 (1.1)	NR	NR	45
ASPIRE <sup>71</sup>	PBO i.v. + MTX	54 weeks	NR	235	6.7 (1)	4.6 (1.8)	-2.1 (NR)	Defined as DAS28 <2.6, 15.0%
ASPIRE <sup>71</sup>	IFX i.v. 3 mg/kg at weeks 0, 2 and 6 and every 8 weeks thereafter + MTX	54 weeks	NR	294	6.6 (1)	4.0 (1.8) <sup>c</sup>	-2.6 (NR)	21.2
BeST <sup>78</sup>	Sequential monotherapy (DAS steered)	6 months	DAS44	126	DAS44 4.5 (0.9)	3	-1.5 (NR)	NR
BeST <sup>78</sup>	Step-up combination therapy (DAS steered)	6 months	DAS44	121	DAS44 4.5 (0.8)	3	-1.5 (NR)	NR
BeST <sup>78</sup>	Initial combination therapy with prednisone (DAS steered)	6 months	DAS44	133	DAS44 4.4 (0.9)	2.2	-2.2 (NR)	NR
BeST <sup>78</sup>	Initial combination therapy with IFX (DAS steered)	6 months	DAS44	128	DAS44 4.3 (0.9)	2.2	-2.1 (NR)	NR
Durez <i>et al.</i> , 2007 <sup>120</sup>	MTX	52 weeks (study RCT end point)	DAS28-CRP	14	5.2 (0.8)	3.26 (1.3)	-1.94 (NR)	NR
Durez <i>et al.</i> , 2007 <sup>120</sup>	MTX + i.v. MP	52 weeks (study RCT end point)	DAS28-CRP	15	5.3 (1)	2.77 (1.09)	-2.53 (NR)	NR
Durez <i>et al.</i> , 2007 <sup>120</sup>	IFX 3 mg/kg i.v. at weeks 0, 2, 6, 14, 22, 30, 46 + MTX	52 weeks (study RCT end point)	DAS28-CRP	15	5.3 (1)	2.79 (0.77)	-2.51 (NR)	NR
IDEA <sup>95</sup>	MP 250 mg i.v. at week 0, PBO i.v. at weeks 2, 6, 14, 22 + MTX	26 weeks	NR	56	NR	NR	NR	DAS (assumed DAS44 < 1.6), 44.6%

continued

TABLE 347 Disease Activity Score: population 1 biologics vs. DMARD(s) or PBO (continued)

Trial name/ study	Treatment arms for which data extraction performed	Assessment time point	DAS28-ESR or DAS28-CRP where stated	n analysed	Mean DAS28 at follow-up (SD)	DAS28 mean change from baseline (SD)	% achieving DAS28 remission (defined threshold)
IDEA <sup>95</sup>	IFX 3 mg/kg i.v. at weeks 0, 2, 6, 14, 22 + MTX (IFX dose modifications permitted according to DAS44 from week 26)	26 weeks	NR	54	NR	NR	33.3
Quinn <i>et al.</i> , 2005 <sup>110</sup>	MTX + PBO	14 weeks (primary end point)	Not stated	10	6.0 (4.9–6.8) <sup>d,e</sup>	–1.0 (NR)	NR
Quinn <i>et al.</i> , 2005 <sup>110</sup>	IFX 3 mg/kg + MTX	14 weeks (primary end point)	Not stated	10	2.9 (2.3–3.8) <sup>a,d,e</sup>	–3.3 (NR)	NR
Quinn <i>et al.</i> , 2005 <sup>110</sup>	MTX + PBO	54 weeks (study RCT end point)	Not stated	10	4.6 (3.1–5.1) <sup>d,e</sup>	–2.4 (NR)	NR
Quinn <i>et al.</i> , 2005 <sup>110</sup>	IFX 3 mg/kg + MTX	54 weeks (study RCT end point)	Not stated	10	2.7 (2.0–3.5) <sup>d,e</sup>	–3.5 (NR)	NR

ASPIRE, Active controlled Study of Patients receiving Infliximab for the treatment of Rheumatoid arthritis of Early onset; DAS44, Disease Activity Score 44 joints; HIT HARD, High Induction Therapy with Anti-Rheumatic Drugs (adalimumab and methotrexate); IDEA, Remission induction comparing infliximab and high-dose intravenous steroid, followed by treat-to-target: a double-blind, randomised, controlled trial in new-onset, treatment-naive, rheumatoid arthritis; NR, not reported; OPTIMA, OPTimal protocol for treatment Initiation with Methotrexate and Adalimumab.

ADA = ADA 40 mg every other week subcutaneously.

ETN = ETN 25 mg twice a week subcutaneously.

GOL = GOL 50 mg every 4 weeks subcutaneously.

IFX = IFX 3 mg/kg intravenously at weeks 0, 2, 6 and every 8 weeks thereafter (with dose escalation permitted after week 12 if lack of response).

a  $p < 0.05$ .

b Median (5th, 95th centile range).

c  $p < 0.01$ .

d Median (interquartile range).

e Estimated from graphical data.

Data are shown to the level of accuracy available in the source material.



TABLE 348 Disease Activity Score: populations 2 and 3 head to head

Trial name	Treatment arms for which data extraction performed	Assessment time point	DAS28-ESR or DAS28-CRP where stated	n analysed	Mean DAS28 at baseline (SD)	Mean DAS28 at follow-up (SD)	DAS28 mean change from baseline (SD)	% achieving DAS28 remission (defined threshold)
ATTEST <sup>74</sup>	PBO + MTX	Day 197	DAS28-ESR	110	6.8 (1.0)	5.32 (NR)	-1.48	Defined as DAS28-ESR < 2.6, 2.9%
ATTEST <sup>74</sup>	IFX + MTX	Day 197	DAS28-ESR	165	6.8 (0.9)	4.55 (NR)	-2.25 <sup>a</sup>	12.8
ATTEST <sup>74</sup>	ABT + MTX	Day 197	DAS28-ESR	156	6.9 (1.0)	4.37 (NR)	-2.53 <sup>a</sup>	11.3
AMPLE <sup>66</sup>	ABT s.c.	1 year (primary end point)	DAS28-CRP	318	5.5 (1)	3.188	-2.30 (0.08)	43.3 (< 2.6)
AMPLE <sup>66</sup>	ADA	1 year (primary end point)	DAS28-CRP	328	5.5 (1)	3.188	-2.27 (0.08)	41.9 (< 2.6)
RED-SEA <sup>114</sup>	ADA + cDMARDs (n = 60)	24 weeks	DAS28-CRP	60	5.6 (0.9)	4.16 (NR)	-1.44 (NR)	NR
RED-SEA <sup>114</sup>	ETN50 + cDMARDs (n = 60)	24 weeks	DAS28-CRP	60	5.8 (0.9)	4.04 (NR)	-1.76 (NR)	NR
RED-SEA <sup>114,319</sup>	ADA + cDMARDs (n = 60)	12 months	DAS28-CRP	60	Median 5.8 (5.1–6.1) <sup>b</sup>	4.4 (3.1–5.0) <sup>b</sup>	Median -1.4	NR
RED-SEA <sup>114</sup>	ETN50 + cDMARDs (n = 60)	12 months	DAS28-CRP	60	Median 5.7 (5.0–6.5) <sup>b</sup>	4.6 (3.5–5.6) <sup>b</sup>	Median -1.1	NR
ADACTA <sup>58</sup>	TCZ 8 mg/kg i.v. every 4 weeks + s.c. PBO ADA	24 weeks	DAS28-ESR	163	6.7 (0.9)	3.4 (NR)	-3.3	(DAS28 < 2.6)
ADACTA <sup>58</sup>	ADA 40 mg s.c. every 2 weeks + i.v. PBO TCZ	24 weeks	DAS28-ESR	162	6.8 (0.9)	5.0 (NR)	-1.8 <sup>a</sup>	65/163 (39.9%) 17/162 (10.5%) <sup>b</sup>

ETN50, etanercept 50 mg once a week subcutaneously; NR, not reported.  
 ABT i.v. = BT ≈ 10 mg/kg intravenously on weeks 0, 2 and 4, and every 4 weeks thereafter.  
 ABT s.c. = ABT 125 mg once per week subcutaneously, following an optional i.v. loading dose of ≈ 10 mg/kg based on weight range.  
 ADA = ADA 40 mg every other week subcutaneously.  
 CTZ = s.c. CTZ 400 mg at weeks 1, 2 and 4, then 200 mg every other week.  
 ETN = ETN 25 mg twice a week subcutaneously.  
 IFX = IFX 3 mg/kg intravenously at weeks 0, 2, 6 and every 8 weeks thereafter (with dose escalation permitted after week 12 if lack of response).  
 TCZ = TCZ 8 mg/kg intravenously every 4 weeks.  
 a  $p < 0.01$ .  
 b Median (interquartile range).

TABLE 349 Disease Activity Score: populations 2 and 3 biologic vs. DMARD(s) or PBO

Trial name/ study	Treatment arms for which data extraction performed	Assessment time point	DAS28-ESR or DAS28-CRP where stated	<i>n</i> analysed	Mean DAS28 at baseline (SD)	Mean DAS28 at follow-up (SD)	DAS28 mean change from baseline (SD)	% change from baseline	% achieving DAS28 remission (defined threshold)
AIM <sup>61,62</sup>	MTX + PBO ( <i>n</i> = 219)	12 months	CRP	219	6.4 (0.1) CRP	NR	NR	NR	DAS28 < 3.2, 9.9%
AIM <sup>61</sup>	ABT i.v. + MTX ( <i>n</i> = 433)	12 months	CRP	433	6.4 (0.08) CRP	NR	NR	NR	DAS28 < 2.6, 1.9% DAS28 < 3.2, 42.5%
ASSET <sup>72</sup>	PBO + MTX	4 months (primary end point and study RCT end point)	DAS28-CRP	22	5.3 (0.9)	4.75 (NR)	-0.55 (95% CI -0.95 to -0.16)	NR	DAS28 < 2.6, 23.8% <sup>a</sup> 0.0 (< 2.6)
ASSET <sup>72</sup>	ABT i.v. (≈ 10 mg/kg) + MTX	4 months (primary end point and study RCT end point)	DAS28-CRP	26	5.3 (1)	3.62 (NR)	-1.68 (95% CI -2.15 to -1.2)	NR	15.4 (< 2.6)
Van De Putte <i>et al.</i> , 2004 <sup>122</sup>	PBO s.c.	26 weeks	NR	110	7.1 (0.9)	6.4 (NR)	-0.7 (1.3)	-9.1	NR
Van De Putte <i>et al.</i> , 2004 <sup>122</sup>	ADA 40 mg s.c. every other week monotherapy	26 weeks	NR	113	7.1 (0.8)	5.4 (NR)	-1.7 (1.6)	-23.8 <sup>b</sup>	NR
CERTAIN <sup>79</sup>	PBO + cDMARDs	24 weeks (primary end point and study RCT end point)	DAS28-ESR	98	4.47 (0.3)	4.5	-0.07 (1.20)	NR	5.5 (< 2.6)
CERTAIN <sup>79</sup>	CTZ 400 mg at weeks 0, 2 and 4 then 200 mg every 2 weeks + DMARDs	24 weeks (primary end point and study RCT end point)	DAS28-ESR	96	4.53 (0.4)	3.38	-1.12 (1.06)	NR	26.1 (< 2.6)

Trial name/ study	Treatment arms for which data extraction performed	Assessment time point	DAS28-ESR or DAS28-CRP where stated	n analysed	Mean DAS28 at baseline (SD)	Mean DAS28 at follow-up (SD)	DAS28 mean change from baseline (SD)	% change from baseline	% achieving DAS28 remission (defined threshold)
REALISTIC <sup>113</sup>	PBO + existing cDMARDs	12 weeks	DAS28-CRP	29	NR	NR	-0.80 <sup>c</sup>	NR	NR
REALISTIC <sup>113</sup>	CTZ 400 mg weeks 0, 2, 4 then 200 mg every 2 weeks + existing cDMARDs	12 weeks	DAS28-ESR	134	NR	NR	-0.80 <sup>c</sup> -1.88 <sup>c</sup> -1.94 <sup>c</sup>	NR	NR
ADORE <sup>59,60</sup>	ETN monotherapy (n = 159)	16 weeks	ESR	156	6.2 ESR	4.25 (NR)	1.95	NR	DAS28 (4) <2.6, 14.6% <sup>d</sup>
ADORE <sup>59</sup>	ETN + MTX (n = 155)	16 weeks	ESR	151	6.3 ESR	4.1 (NR)	2.20	NR	DAS28 (3) <2.6, 15.2% <sup>e</sup> DAS28 (4) <2.6, 17.3%
CREATE IIb <sup>96</sup>	DMARD + PBO	24 weeks	NR	65	6.3 (0.76)	5.3 (NR)	-1 (1.2)	NR	DAS28 (3) <2.6, 15.1%
CREATE IIb <sup>96</sup>	ETN50 + DMARD	24 weeks	NR	64	6.4 (0.85)	4.1 (NR)	-2.3 (1.38)	NR	NR
JESMR <sup>140</sup>	ETN 25 mg every 2 weeks monotherapy	24 weeks (primary end point)	Not stated	69	6.1 (95% CI 5.9 to 6.2)	4.1 (95% CI 3.8 to 4.5)	-2.0 (NR)	NR	10.1 (<2.6)
JESMR <sup>140</sup>	ETN 25 mg every 2 weeks + MTX 6-8 mg/week	24 weeks (primary end point)	Not stated	73	6.0 (95% CI 5.8 to 6.2)	3.3 (95% CI 3.0 to 3.5) <sup>b</sup>	-2.7 (NR)	NR	27.4 <sup>a</sup> (<2.6)
JESMR <sup>140</sup>	ETN 25 mg every 2 weeks monotherapy	52 weeks (primary end point)	Not stated	69	6.1 (0.9)	4.2 (1.5)	-1.9 (NR)	NR	18.8 (<2.6)
JESMR <sup>140</sup>	ETN 25 mg every 2 weeks + MTX 6-8 mg/week	52 weeks (primary end point)	Not stated	73	6.0 (1.0)	3.0 (1.0) <sup>b</sup>	3.0 (NR)	NR	35.6 <sup>a</sup> (<2.6)

continued

TABLE 349 Disease Activity Score: populations 2 and 3 biologic vs. DMARD(s) or PBO (continued)

Trial name/ study	Treatment arms for which data extraction performed	Assessment time point	DAS28-ESR or DAS28-CRP where stated	n analysed	Mean DAS28 at baseline (SD)	Mean DAS28 at follow-up (SD)	DAS28 mean change from baseline (SD)	% change from baseline	% achieving DAS28 remission (defined threshold)
LARA <sup>102</sup>	MTX + DMARD	24 weeks	ESR	142	5.9 (0.7)	NR	NR	NR	DAS < 2.6, 5/142 (3.5%)
LARA <sup>102</sup>	ETN50 + MTX	24 weeks		279	5.9 (0.6)	NR	NR	NR	DAS < 3.2, 12.0%
RACAT <sup>111</sup>	MTX + SSZ + HCQ	24 weeks	CRP	157	5.8 (0.9)	4.1 (NR)	-1.79 (1.20)	NR	DAS < 2.6, 70/279 (25.1%) <sup>b</sup>
RACAT <sup>111</sup>	ETN50 + MTX	24 weeks		161	5.9 (0.9)	3.8 (NR)	-2.06 (1.35)	NR	DAS < 3.2, 47.0% <sup>b</sup>
RACAT <sup>111</sup>	MTX + SSZ + HCQ (n = 178) In analysis n = 154 (of whom 39 switched to ETN)	48 weeks	CRP	154	NR	NR	-2.12 (1.28)	NR	DAS28 ≤ 2.6, 12.7%
RACAT <sup>111</sup>	ETN50 + MTX (n = 175) In analysis n = 155 (of whom 41 switched to MTX + SSZ + HCQ)	48 weeks		155	NR	NR	-2.29 (1.30)	NR	DAS28 ≤ 3.2, 24.8%
									DAS28 ≤ 2.6, 21.7% <sup>a</sup>
									DAS28 ≤ 3.2, 34.8% <sup>a</sup>
									DAS28 ≤ 2.6, 20.8%
									DAS28 ≤ 3.2, 37.0%
									DAS28 ≤ 2.6, 25.2%
									DAS28 ≤ 3.2, 41.9%

Trial name/ study	Treatment arms for which data extraction performed	Assessment time point	DAS28-ESR or DAS28-CRP where stated	n analysed	Mean DAS28 at baseline (SD)	Mean DAS28 at follow-up (SD)	DAS28 mean change from baseline (SD)	% change from baseline	% achieving DAS28 remission (defined threshold)
APPEAL <sup>67,68</sup>	MTX + DMARD (SSZ, HCQ or LEF)	16 weeks (primary end point and study RCT end point)	DAS28-ESR	103	6.1 (1.1)	4.4	-1.7 (NR)	27.5	7.8 (<0.26)
			DAS28-CRP		5.34 (1.1)	3.7	-1.64 (NR)	31.0	21.4 (<0.26)
APPEAL <sup>68</sup>	ETN 25 mg twice weekly (licensed dose) + MTX	16 weeks (primary end point and study RCT end point)	DAS28-ESR	197	6.1 (1.1)	3.8 <sup>b</sup>	-2.3 (NR)	38.3 <sup>b</sup>	15.7 (<0.26)
			DAS28-CRP		5.23 (1.1)	3.1 <sup>b</sup>	-2.13 (NR)	40.3 <sup>b</sup>	41.6 <sup>b</sup> (<0.26)
GO-FORTH <sup>91</sup>	PBO every 4 weeks + MTX 6–8 mg/week	14 weeks (primary end point)	DAS28-ESR	88	5.6 (0.99)	5.17 (NR)	-0.43 (1.20)	NR	3.4 (<2.6)
GO-FORTH <sup>91</sup>	GOL 50 mg s.c. every 4 weeks + MTX 6–8 mg/week	14 weeks (primary end point)	DAS28-ESR	86	5.5 (1.18)	3.52 (NR)	-1.98 (1.25) <sup>b</sup>	NR	31.4 <sup>b</sup> (<2.6)
GO-FORTH <sup>91</sup>	PBO every 4 weeks + MTX 6–8 mg/week	24 weeks (study RCT end point)	DAS28-ESR	88	5.6 (0.99)	5.0 (NR)	-0.60 (1.38)	NR	6.8 (<2.6)
GO-FORTH <sup>91</sup>	GOL 50 mg s.c. every 4 weeks + MTX 6–8 mg/week	24 weeks (study RCT end point)	DAS28-ESR	86	5.5 (1.18)	3.45 (NR)	-2.05 (1.23) <sup>b</sup>	NR	34.9 <sup>b</sup> (<2.6)
GO-FORWARD <sup>92</sup>	PBO s.c. every 4 weeks + MTX	14 weeks	DAS28-CRP	133	DAS28-CRP 5.458 (4.672–6.09) <sup>f</sup>	NR	NR	NR	1.5
			DAS28-ESR		DAS28-ESR 6.111 (5.260–6.57) <sup>f</sup>				
GO-FORWARD <sup>92</sup>	GOL 50 mg s.c. every 4 weeks + MTX	14 weeks	DAS28-CRP	89	DAS28-CRP 5.766 (4.628–6.32) <sup>f</sup>	NR	NR	NR	15.7 <sup>b</sup>
			DAS28-ESR		DAS28-ESR 6.105 (5.366–6.940) <sup>f</sup>				

continued

TABLE 349 Disease Activity Score: populations 2 and 3 biologic vs. DMARD(s) or PBO (continued)

Trial name/ study	Treatment arms for which data extraction performed	Assessment time point	DAS28-ESR or DAS28-CRP where stated	n analysed	Mean DAS28 at baseline (SD)	Mean DAS28 at follow-up (SD)	DAS28 mean change from baseline (SD)	% change from baseline	% achieving DAS28 remission (defined threshold)
GO-FORWARD <sup>92</sup>	PBO s.c. every 4 weeks + MTX	24 weeks	DAS28-CRP DAS28-ESR	133	5.458 (4.672–6.09) <sup>f</sup>	NR	NR	NR	6.0
GO-FORWARD <sup>92</sup>	GOL 50 mg s.c. every 4 weeks + MTX	24 weeks	DAS28-CRP DAS28-ESR	89	6.111 (5.260–6.57) <sup>f</sup>	NR	NR	NR	20.2
Kay <i>et al.</i> , 2008 <sup>98</sup>	PBO s.c. + MTX	16 weeks	Both measures reported	35	6.105 (5.366–6.940) <sup>f</sup> DAS28-CRP 5.8 (5.2–6.0) <sup>f</sup>	4.8 <sup>f</sup>	DAS28-CRP –1.0 (1.0) –1.0 (–1.8 to –0.0) <sup>f</sup>	NR	DAS28-CRP 0 (DAS28 < 2.6) DAS28-ESR 0 (DAS28 < 2.6)
Kay <i>et al.</i> , 2008 <sup>98</sup>	GOL 50 mg s.c. every 4 weeks + MTX	16 weeks	Both measures reported	35	DAS28-ESR 6.3 (5.7–7.0) <sup>f</sup> DAS28-CRP 5.9 (5.5–6.9) <sup>f</sup>	3.9 <sup>f</sup>	DAS28-CRP –2.0 (1.3)	NR	DAS28-CRP 11 <sup>a,f</sup> (DAS28 < 2.6) DAS28-ESR 5.7 (DAS28 < 2.6)
START <sup>118</sup>	PBO + MTX	22 weeks (primary end point and study RCT end point)	Not stated	363	NR	4.4 (1.40)	DAS28-ESR 6.4 (5.6–7.3) <sup>f</sup> –2.0 (–2.6, –1.5) <sup>f</sup> DAS28-ESR –2.1 (1.4) –2.2 (–2.8, –1.5) <sup>b</sup>	NR	14 (< 2.6)

Trial name/ study	Treatment arms for which data extraction performed	Assessment time point	DAS28-ESR or DAS28-CRP where stated	n analysed	Mean DAS28 at baseline (SD)	Mean DAS28 at follow-up (SD)	DAS28 mean change from baseline (SD)	% change from baseline	% achieving DAS28 remission (defined threshold)
START <sup>118</sup>	IFX 3 mg/kg + MTX	22 weeks (primary end point and study RCT end point)	Not stated	360	NR	3.5 (1.4) <sup>b</sup>	NR	NR	31 <sup>b</sup> (<2.6)
Wong <i>et al.</i> , 2009 <sup>125</sup>	PBO + MTX (with crossover for PBO group to open-label IFX at week 2)	Week 16	NR	NR	6.4 (0.8)	6.7	0.3 (NR)	NR	NR
Wong <i>et al.</i> , 2009 <sup>125</sup>	IFX 3 mg/kg at weeks 0, 2, 6 and 8 weeks thereafter + MTX	Week 16	NR	NR	6.2 (0.9)	4.4 <sup>b</sup>	-1.8 (NR)	NR	NR
ACT-RAY <sup>57</sup>	TCZ + oral PBO	24 weeks	DAS28-ESR	267	6.36 (1.00)	3.15 (NR)	-3.21 (1.3)	NR	34.8
ACT-RAY <sup>57</sup>	TCZ + MTX	24 weeks	DAS28-ESR	277	6.33 (0.98)	2.9 (NR)	-3.43 (1.3) <sup>a</sup>	NR	40.4% ( $p=0.19$ for absolute difference of 5.65%, 95% CI -2.41% to 13.71%)
ACT-RAY <sup>57</sup>	TCZ + oral PBO	52 weeks	NR	NR	6.36 (1.00)	2.62 (NR)	-3.74	NR	36.6
ACT-RAY <sup>57</sup>	TCZ + MTX	52 weeks	NR	NR	6.33 (0.98)	2.67 (NR)	-3.66	NR	45.5 <sup>a</sup>
MEASURE <sup>03</sup>	PBO + MTX	12 weeks	NR	NR	NR	NR	-0.8	NR	NR
MEASURE <sup>03</sup>	TCZ + MTX	12 weeks	NR	NR	NR	NR	-2.7	NR	NR
SAMURAI <sup>115</sup>	cDMARDs disease activity	24 weeks	NR	145	6.4 (0.9)	5.91 (NR)	-0.49 (NR)	NR	NR
SAMURAI <sup>115</sup>	TCZ monotherapy	24 weeks	NR	157	6.5 (0.8)	2.75 (NR)	-3.75 (NR)	NR	NR
SAMURAI <sup>115</sup>	cDMARDs disease activity	52 weeks	NR	145	6.4 (0.9)	NR	NR	NR	DAS28 < 2.6, 3%
SAMURAI <sup>115</sup>	TCZ monotherapy	52 weeks	NR	157	6.5 (0.8)	NR	NR	NR	DAS28 < 2.6, 59% <sup>b</sup>
SATORI <sup>116</sup>	PBO i.v. every 4 weeks + MTX	24 weeks	NR	64	6.2 (0.9)	5.13 (NR)	-1.07 (NR)	NR	NR
SATORI <sup>116</sup>	TCZ 8 mg/kg i.v. every 4 weeks + PBO capsules	24 weeks	NR	61	6.1 (0.9)	2.86 (NR)	-3.24 (NR)	NR	NR

continued

**TABLE 349** Disease Activity Score: populations 2 and 3 biologic vs. DMARD(s) or PBO (continued)

Trial name/ study	Treatment arms for which data extraction performed	Assessment time point	DAS28-ESR or DAS28-CRP where stated	n analysed	Mean DAS28 at baseline (SD)	Mean DAS28 at follow-up (SD)	DAS28 mean change from baseline (SD)	% change from baseline	% achieving DAS28 remission (defined threshold)
TOWARD <sup>21</sup>	PBO i.v. every 4 weeks + stable cDMARDs (n = 415 randomised)	24 weeks	NR	413	6.6 (1.0)	5.44 (NR)	-1.16	NR	DAS28 < 2.6, 3%
TOWARD <sup>21</sup>	TCZ 8 mg/kg i.v. every 4 weeks + stable DMARDs (n = 805 randomised)	24 weeks	NR	803	6.7 (1.0)	3.53 (NR)	-3.17 <sup>b</sup>	NR	30% <sup>b</sup>
(AiC information has been removed)	(AiC information has been removed)	(AiC information has been removed)	(AiC information has been removed)	(AiC information has been removed)	(AiC information has been removed)	(AiC information has been removed)	(AiC information has been removed)	(AiC information has been removed)	(AiC information has been removed)
(AiC information has been removed)	(AiC information has been removed)	(AiC information has been removed)	(AiC information has been removed)	(AiC information has been removed)	(AiC information has been removed)	(AiC information has been removed)	(AiC information has been removed)	(AiC information has been removed)	(AiC information has been removed)

AIM, Abatacept in Inadequate responders to Methotrexate; CREATE IIb, A 6-month Randomised, Double-blind, Open Arm Comparator, Phase IIb, With AZD9056, in Patients With Rheumatoid Arthritis (RA); ASSET, Abatacept Systemic Sclerosis Trial; ETN50, etanercept 50 mg once a week subcutaneously; MEASURE, secukinumab in ankylosing spondylitis; NR, not reported; REALISTIC, RA Evaluation in Subjects receiving TNF Inhibitor Certolizumab pegol; SATORI, Study of Active controlled Tocilizumab for Rheumatoid arthritis patients with an Inadequate response to methotrexate.  
 ABT i.v. = BT ≈10 mg/kg intravenously on weeks 0, 2 and 4, and every 4 weeks thereafter.  
 ABT s.c. = ABT 125 mg once per week subcutaneously, following an optional i.v. loading dose of ≈10 mg/kg based on weight range.  
 ADA = ADA 40 mg every other week subcutaneously.  
 CTZ = s.c. CTZ 400 mg at weeks 1, 2 and 4, then 200 mg every other week.  
 ETN = ETN 25 mg twice a week subcutaneously.  
 GOL = GOL 50 mg every 4 weeks subcutaneously.  
 IFX = IFX 3 mg/kg intravenously at weeks 0, 2, 6 and every 8 weeks thereafter (with dose escalation permitted after week 12 if lack of response).  
 TCZ = TCZ 8 mg/kg intravenously every 4 weeks.  
 a *p* < 0.05.  
 b *p* < 0.01.  
 c Least square.  
 d The DAS28 (4) score is a function of ESR, the patient's Visual Analogue Scale of General Health (GH VAS), and the number of tender and swollen joints assessed using the 28-joint count method.  
 e DAS28 (3) score, is a function of ESR, tender joint count and swollen joint count, but not GH VAS.  
 f Median (interquartile range).  
 Data are shown to the level of accuracy available in the source material.



TABLE 350 Health Assessment Questionnaire Disability Index: population 1 trials

Trial name/ study	Treatment arms for which data extraction performed	Assessment time point	n analysed	Mean HAQ-DI score at baseline (range 0–3) (SD)	Mean HAQ-DI score at follow-up (range 0–3) (SD)	HAQ-DI mean change from baseline (SD)	% change from baseline
Bejarano <i>et al.</i> , 2008 <sup>77</sup>	MTX + PBO	Week 56	73	1.3 (0.6)	0.9 (NR)	-0.4 (0.7)	
Bejarano <i>et al.</i> , 2008 <sup>77</sup>	ADA + MTX	Week 56	75	1.3 (0.6)	0.6 (NR)	-0.7 (0.6)	
GUEPARD <sup>93</sup>	Initial MTX	Week 12	32	1.41 (0.74)	0.9 (NR)	-0.51 (95% CI -0.30 to -0.72)	NR
GUEPARD <sup>93</sup>	Initial ADA + MTX	Week 12	33	1.69 (0.59)	0.87 (NR)	-0.82 (95% CI -0.52 to -1.11)	NR
GUEPARD <sup>93</sup>	Initial MTX	Week 52	32	NR	NR	-0.93 (95% CI -0.69 to -1.17)	NR
GUEPARD <sup>93</sup>	12 weeks, then step-up therapy in both groups based on DAS28	Week 52	33	NR	NR	-1.02 (95% CI -0.81 to -1.24)	NR
HIT HARD <sup>94</sup>	MTX + PBO	24 weeks (study RCT end point)	85	1.3 (0.6)	0.72 (0.6)	-0.58 (NR)	NR
HIT HARD <sup>94</sup>	ADA + MTX	24 weeks (study RCT end point)	87	1.4 (0.6)	0.49 (0.6)	-0.91 (NR)	NR
OPERA <sup>107</sup>	MTX + PBO + steroid	12 months (primary end point and study RCT end point)	91	1.00 (0.25, 2.31) <sup>a</sup>	0.13 (0, 1.5) <sup>a</sup>	-0.63 (-0.82, 0.38) <sup>a</sup>	NR
OPERA <sup>107</sup>	ADA + MTX + steroid	12 months (primary end point and study RCT end point)	89	1.13 (0.17, 2.58) <sup>a</sup>	0.25 (0, 1.44) <sup>a</sup>	-0.88 (-2.46, 0.13) <sup>a</sup>	NR
OPTIMA <sup>108</sup>	MTX + PBO	26 weeks (study RCT end point)	517	1.6 (0.65)	0.9	-0.66 (0.73) (n = 512)	NR

continued

TABLE 350 Health Assessment Questionnaire Disability Index: population 1 trials (continued)

Trial name/ study	Treatment arms for which data extraction performed	Assessment time point	n analysed	Mean HAQ-DI score at baseline (range 0–3) (SD)	Mean HAQ-DI score at follow-up (range 0–3) (SD)	HAQ-DI mean change from baseline (SD)	% change from baseline
OPTIMA <sup>108</sup>	ADA + MTX	26 weeks (study RCT end point)	515	1.61 (0.69)	0.7	-0.89 (0.74) (n = 512)	NR
PREMIER <sup>109</sup>	MTX + PBO	1 year (primary end point)	256	1.5 (0.7)	0.7 (0.6)	-0.8 (0.6)	NR
PREMIER <sup>109</sup>	ADA monotherapy + PBO step-up week 16	1 year (primary end point)	272	1.6 (0.6)	0.8 (0.6)	-0.8 (0.7)	NR
PREMIER <sup>109</sup>	ADA + MTX step-up week 16	1 year (primary end point)	266	1.5 (0.6)	0.5 (0.5)	-1.1 (0.6)	NR
PREMIER <sup>109</sup>	MTX + PBO	2 years (study RCT end point)	256	1.5 (0.7)	0.5 (0.6)	-0.9 (0.6)	NR
PREMIER <sup>109</sup>	ADA monotherapy + PBO step-up week 16	2 years (study RCT end point)	272	1.6 (0.6)	0.6 (0.6)	-0.9 (0.6)	NR
PREMIER <sup>109</sup>	ADA + MTX step-up week 16	2 years (study RCT end point)	266	1.5 (0.6)	0.3 (0.5)	-1.0 (0.7)	NR
COMET <sup>81</sup>	MTX + PBO	Week 52	263	1.64 (0.65)	0.92 (0.74)	-0.72	NR
COMET <sup>81</sup>	ETN + MTX	Week 52	265	1.70 (0.68)	0.68 (0.71)	-1.02 <sup>b</sup>	NR
COMET <sup>82</sup>	MTX in year 1, MTX in year 2 n = 99 at start of period 2	From week 52 to week 104	99	NR	NR	Non-significant change from baseline	NR
COMET <sup>81</sup>	MTX in year 1, ETN + MTX in year 2 n = 90 at start of period 2	From week 52 to week 104	90	NR	NR	0.17 (0.42) <sup>b</sup>	NR
COMET <sup>81-83</sup>	ETN + MTX in year 1, ETN + MTX in year 2 n = 111 at start of period 2	From week 52 to week 104	111	NR	NR	Non-significant change from baseline	NR

Trial name/ study	Treatment arms for which data extraction performed	Assessment time point	n analysed	Mean HAQ-DI score at baseline (range 0–3) (SD)	Mean HAQ-DI score at follow-up (range 0–3) (SD)	HAQ-DI mean change from baseline (SD)	% change from baseline
COMET <sup>81</sup>	ETN + MTX in year 1, ETN in year 2  n = 111 at start of period 2	From week 52 to week 104	111	NR	NR	Non-significant change from baseline	NR
ERA/Bathon and Genovese, 2003 <sup>139</sup> (multicentre)	MTX + PBO	12 months (study RCT end point)	217	NR	NR	–0.76 (SE 0.05)	NR
ERA/Bathon and Genovese, 2003 <sup>139</sup> (multicentre)	ETN 25 mg every 2 weeks + PBO	12 months (study RCT end point)	207	NR	NR	–0.73 (SE 0.05)	NR
GO-BEFORE <sup>90</sup>	PBO + MTX	24 weeks	160	1.5 (0.64)	NR	NR	36.95
GO-BEFORE <sup>90</sup>	GOL 50 mg s.c. every 4 weeks + MTX	24 weeks	159	1.5 (0.66)	NR	NR	43.65
Kume <i>et al.</i> , 2011 <sup>100</sup>	ADA	6 months	22	NR	NR	–0.69 (0.11)	NR
Kume <i>et al.</i> , 2011 <sup>100</sup>	ETN	6 months	21	NR	NR	–0.68 (0.09)	NR

ERA, Early Rheumatoid Arthritis (etanercept); HIT HARD, High Induction Therapy with Anti-Rheumatic Drugs (adalimumab and methotrexate); NR, not reported; OPTIMA, OPTimal protocol for treatment Initiation with Methotrexate and Adalimumab.  
 ADA = ADA 40 mg every other week subcutaneously.  
 ETN = ETN 25 mg twice a week subcutaneously.  
 GOL = GOL 50 mg every 4 weeks subcutaneously.  
 a Median (5th, 95th centile range).  
 b  $p < 0.01$ .  
 Data are shown to the level of accuracy available in the source material.

TABLE 351 Health Assessment Questionnaire Disability Index: populations 2 and 3 head-to-head trials

Trial name/ study	Treatment arms for which data extraction performed	Assessment time point	<i>n</i> analysed	Mean HAQ-DI score at baseline (range 0–3) (SD)	Mean HAQ-DI score at follow-up (range 0–3) (SD)	HAQ-DI mean change from baseline (SD)	% change from baseline
ATTEST <sup>74</sup>	PBO + MTX	Day 197	110	1.8 (0.7)	NR	NR	% achieving ≥ 0.3 improvement from baseline = 40.9
ATTEST <sup>74</sup>	IFX + MTX	Day 197	165	1.7 (0.7)	NR	NR	% achieving ≥ 0.3 improvement from baseline = 58.8 <sup>a</sup> (vs. PBO+MTX)
ATTEST <sup>74</sup>	ABT + MTX	Day 197	156	1.8 (0.6)	NR	NR	% achieving ≥ 0.3 improvement from baseline = 61.5 <sup>a</sup> (vs. PBO+MTX)
AMPLE <sup>66</sup>	ABT s.c.	1 year (primary end point)	318	1.5 (0.7)	NR	NR	41.7
AMPLE <sup>144</sup>	ADA	1 year (primary end point)	328	1.5 (0.7)	NR	NR	38.7
ADACTA <sup>58</sup>	TCZ 8 mg/kg i.v. every 4 weeks + s.c. PBO ADA	24 weeks	163	1.6 (0.6)	0.9 (NR)	-0.7	NR
ADACTA <sup>58</sup>	ADA 40 mg s.c. every 2 weeks + i.v. PBO TCZ	24 weeks	162	1.7 (0.6)	1.2 (NR)	-0.5	NR
deFilippis <i>et al.</i> , 2006 <sup>85</sup>	ETN + MTX	22 weeks	16	1.89 (0.65)	NR	NR	-17.5

Trial name/ study	Treatment arms for which data extraction performed	Assessment time point	<i>n</i> analysed	Mean HAQ-DI score at baseline (range 0–3) (SD)	Mean HAQ-DI score at follow-up (range 0–3) (SD)	HAQ-DI mean change from baseline (SD)	% change from baseline
deFlippis <i>et al.</i> , 2006 <sup>85</sup>	IFX + MTX	22 weeks	16	1.67 (0.68)	NR	NR	-16.2
deFlippis <i>et al.</i> , 2006 <sup>85</sup>	ETN + MTX	54 weeks	16	1.89 (0.65)	NR	NR	-32.3
deFlippis <i>et al.</i> , 2006 <sup>85</sup>	IFX + MTX	54 weeks	16	1.67 (0.68)	NR	NR	-21.6

NR, not reported.  
 ABT i.v. = BT ≈10 mg/kg intravenously on weeks 0, 2 and 4, and every 4 weeks thereafter.  
 ABT s.c. = ABT 125 mg once per week subcutaneously, following an optional i.v. loading dose of ≈10 mg/kg based on weight range.  
 ADA = ADA 40 mg every other week subcutaneously.  
 ETN = ETN 25 mg twice a week subcutaneously.  
 IFX = IFX 3 mg/kg intravenously at weeks 0, 2, 6 and every 8 weeks thereafter (with dose escalation permitted after week 12 if lack of response).  
 TCZ = TCZ 8 mg/kg intravenously every 4 weeks.  
 a *p* < 0.01.  
 Data are shown to the level of accuracy available in the source material.

**TABLE 352** Health Assessment Questionnaire Disability Index: populations 2 and 3 vs. DMARD(s) or PBO

Trial name/ author, year	Treatment arms for which data extraction performed	Assessment time point	n analysed	Mean HAQ-DI score at baseline (range 0–3) (SD)	Mean HAQ-DI score at follow-up (range 0–3) (SD)	HAQ-DI mean change from baseline (SD)	% change from baseline
AIM <sup>61,62</sup>	MTX + PBO	12 months	219	1.7 (0.6)	(Estimate from graph 1.3)	Adjusted -0.50 (0.05)	NR
AIM <sup>61</sup>	ABT i.v. + MTX	12 months	433	1.7 (0.7)	(Estimate from graph 1.05)	Adjusted -0.68 (0.03)	NR
ASSURE <sup>73</sup>	PBO + cDMARDs	1 year (primary end point and study RCT end point)	413	1.5 (0.7) (n = 418)	1.24 (NR)	-0.26	9
ASSURE <sup>73</sup>	ABT + cDMARDs	1 year (primary end point and study RCT end point)	845	1.5 (0.6) (n = 856)	1.03 (NR)	-0.47	30
CHANGE <sup>80</sup>	PBO	24 weeks	87	1.4 (0.7)	1.3 (NR)	0.1 (0.6)	NR
CHANGE <sup>80</sup>	ADA monotherapy	24 weeks	91	1.6 (0.7)	1.4 (NR)	-0.2 (0.6)	NR
DE019 <sup>84</sup>	MTX + PBO (n = 200)	24 weeks	200	1.48 (0.59)	1.24 (NR)	-0.24 (0.52)	-16.2
DE019 <sup>80</sup>	ADA + MTX (n = 207)	24 weeks	207	1.45 (0.63)	0.89 (NR)	-0.56 (0.52)	-38.6
DE019 <sup>80</sup>	MTX + PBO (n = 200)	52 weeks	200	1.48 (0.59)	1.23 (NR)	-0.25 (0.56)	-16.9
DE019 <sup>80</sup>	ADA + MTX (n = 207)	52 weeks	207	1.45 (0.63)	0.86 (NR)	-0.59 (0.57)	-40.7
Van De Putte <i>et al.</i> , 2004 <sup>122</sup>	PBO s.c.	26 weeks	110	1.88 (0.64)	1.81 (NR)	-0.07 (0.49)	1.8
Van De Putte <i>et al.</i> , 2004 <sup>122</sup>	ADA monotherapy	26 weeks	113	1.83 (0.59)	1.45 (NR)	-0.38 (0.60)	-21.3 <sup>a</sup>
ARMADA <sup>69,70</sup>	MTX + PBO	24 weeks	62	1.64 (0.63)	1.37 (NR)	-0.27 (0.57)	-16.5
ARMADA <sup>69</sup>	ADA + MTX	24 weeks	67	1.55 (0.61)	0.93 (NR)	-0.62 (0.63)	-40.0 <sup>a</sup>
CERTAIN <sup>79</sup>	PBO + cDMARDs (biologic-naïve subgroup)	24 weeks (primary end point and study RCT end point)	98	1.11 (0.62)	1.05 (NR)	-0.06	NR

Trial name/ author, year	Treatment arms for which data extraction performed	Assessment time point	<i>n</i> analysed	Mean HAQ-DI score at baseline (range 0–3) (SD)	Mean HAQ-DI score at follow-up (range 0–3) (SD)	HAQ-DI mean change from baseline (SD)	% change from baseline
CERTAIN <sup>79</sup>	CTZ 400 mg at weeks 0, 2 and 4 then 200 mg every 2 weeks + DMARDs (biologic-naïve subgroup)	24 weeks (primary end point and study RCT end point)	96	1.04 (0.60)	0.79 (NR)	-0.25	NR
REALISTIC <sup>113</sup>	PBO + existing cDMARDs	12 weeks	29	NR	NR	-0.10 <sup>b</sup>	NR
REALISTIC <sup>113</sup>	CTZ 400 mg weeks 0, 2, 4 then 200 mg every 2 weeks + existing cDMARDs	12 weeks	134	NR	NR	-0.48 <sup>b</sup>	NR
ADORE <sup>59,60</sup>	ETN monotherapy ( <i>n</i> = 159)	16 weeks	142	1.6	1.01 (NR)	-0.59 (0.69)	NR
ADORE <sup>59</sup>	ETN + MTX ( <i>n</i> = 155)	16 weeks	141	1.7	1.11 (NR)	-0.59 (0.58)	NR
ETN Study 309 <sup>88,89</sup>	SSZ + PBO ( <i>n</i> = 50)	24 weeks	50	1.6 (0.5)	1.5 (NR)	-0.1 (NR)	9.2
ETN Study 309 <sup>88,89</sup>	ETN + PBO ( <i>n</i> = 103)	24 weeks	103	1.7 (0.6)	1.1 (NR)	-0.6 (NR)	35.3 <sup>a</sup> vs. SSZ
ETN Study 309 <sup>88,89</sup>	ETN + SSZ ( <i>n</i> = 101)	24 weeks	101	1.6 (0.6)	1.0 (NR) <sup>c</sup> vs. SSZ	-0.6 (NR)	40.2 <sup>c</sup> vs. SSZ
ETN Study 309 <sup>88,89</sup>	SSZ + PBO ( <i>n</i> = 50)	104 weeks	50	1.6 (0.5)	Non-significant vs. ETN + PBO	(Estimate from graph 0) (NR)	Non-significant vs. ETN + PBO
ETN Study 309 <sup>88,89</sup>	ETN + PBO ( <i>n</i> = 103)	104 weeks	103	1.7 (0.6)	(Estimate from graph 1.6)	(Estimate from graph 0.6) (NR)	NR
ETN Study 309 <sup>88,89</sup>	ETN + SSZ ( <i>n</i> = 101)	104 weeks	101	1.6 (0.6)	(Estimate from graph 1.1) <sup>a</sup> vs. SSZ	(Estimate from graph 0.7) (NR)	NR
JESMR <sup>140</sup>	ETN 25 mg every 2 weeks monotherapy	24 weeks (primary end point)	69	1.3 (0.8)	(Estimate from graph 0.9) <sup>a</sup> vs. SSZ	-0.4 (NR)	NR
JESMR <sup>140</sup>	ETN 25 mg every 2 weeks + MTX 6–8 mg/week	24 weeks (primary end point)	73	1.2 (0.7)	0.9 (0.8)	-0.5 (NR)	NR

continued

TABLE 352 Health Assessment Questionnaire Disability Index: populations 2 and 3 vs. DMARD(s) or PBO (continued)

Trial name/ author, year	Treatment arms for which data extraction performed	Assessment time point	<i>n</i> analysed	Mean HAQ-DI score at baseline (range 0–3) (SD)	Mean HAQ-DI score at follow-up (range 0–3) (SD)	HAQ-DI mean change from baseline (SD)	% change from baseline
JESMR <sup>140</sup>	ETN 25 mg every 2 weeks monotherapy	52 weeks (primary end point)	69	1.3 (0.8)	0.9 (0.7)	−0.4 (NR)	NR
JESMR <sup>140</sup>	ETN 25 mg every 2 weeks + MTX 6–8 mg/week	52 weeks (primary end point)	73	1.2 (0.7)	0.6 (0.6)	−0.6 (NR)	NR
Lan <i>et al.</i> , 2004 <sup>101</sup>	PBO + MTX	12 weeks (primary end point and study RCT end point)	29	1.23	0.99	−0.24	NR
Lan <i>et al.</i> , 2004 <sup>101</sup>	ETN 25 mg twice weekly + MTX	12 weeks (primary end point and study RCT end point)	29	0.99	0.34	−0.65	NR
LARA <sup>102</sup>	MTX + DMARD	24 weeks	142	1.6 (0.7)	NR	Adjusted −0.5 (SE 0.1)	NR
LARA <sup>102</sup>	ETN50 + MTX	24 weeks	279	1.6 (0.7)	NR	Adjusted −0.9 (SE <0.1) <sup>a</sup>	NR
Moreland <i>et al.</i> , 1999 <sup>104</sup>	PBO	6 months	80	1.66 (0.06)	1.54 (NR)	−0.12	NR
Moreland <i>et al.</i> , 1999 <sup>104</sup>	ETN + PBO	6 months	78	1.63 (0.06)	1.04 (NR)	−0.59 <sup>c</sup>	NR
RACAT <sup>111</sup>	MTX + SSZ + HCQ ( <i>n</i> = 178)	24 weeks	155	4 (0.8)	0.97 (0.85)	−0.44 (0.77)	NR
RACAT <sup>111</sup>	ETN50 + MTX ( <i>n</i> = 175)	24 weeks	160	1.5 (0.8)	0.98 (0.87)	−0.51 (0.84)	NR
RACAT <sup>111</sup>	MTX + SSZ + HCQ ( <i>n</i> = 178 randomised)	48 weeks	155	1.4 (0.8)	0.93 (0.85)	−0.46 (0.82)	NR

In analysis *n* = 155 (of whom 39 switched to ETN)



Trial name/ author, year	Treatment arms for which data extraction performed	Assessment time point	<i>n</i> analysed	Mean HAQ-DI score at baseline (range 0–3) (SD)	Mean HAQ-DI score at follow-up (range 0–3) (SD)	HAQ-DI mean change from baseline (SD)	% change from baseline
RACAT <sup>111</sup>	ETN50 + MTX ( <i>n</i> = 175 randomised)  In analysis <i>n</i> = 155 (of whom 41 switched to MTX + SSZ + HCQ)	48 weeks	155	1.5 (0.8)	0.83 (0.81)	-0.64 (0.78)	NR
Wajdula 2000 (reported in Chen <i>et al.</i> , 2006 <sup>123</sup> )	PBO	12 weeks	81	1.8	0.1 (NR)	1.70 (0.60)	NR
Wajdula 2000 (reported in Chen <i>et al.</i> , 2006 <sup>123</sup> )	ETN	12 weeks	99	1.9	0.6 (NR)	1.30 (0.60)	NR
Weinblatt <i>et al.</i> , 1999 <sup>124</sup>	MTX + PBO	24 weeks	30	1.5 <sup>d</sup>	1.1 <sup>d</sup>	-0.4 (NR)	NR
Weinblatt <i>et al.</i> , 1999 <sup>124</sup>	ETN + MTX	24 weeks	59	1.5 <sup>d</sup>	0.8 <sup>a,d</sup>	-0.7 (NR)	NR
APPEAL <sup>67,68</sup>	MTX + DMARD (SSZ, HCQ or LEF)	16 weeks (primary end point and study RCT end point)	100	1.4 (0.7)	0.9	-0.5 (NR)	38.3
APPEAL <sup>68</sup>	ETN 25 mg twice weekly (licensed dose) + MTX	16 weeks (primary end point and study RCT end point)	193	1.4 (0.7)	0.7	-0.7 (NR)	49.4
CREATE IIB <sup>96</sup> (ClinicalTrials.gov)	PBO + DMARD	24 weeks	65	1.4 (0.59)	1.1 (NR)	-0.3 (0.46)	NR
CREATE IIB <sup>96</sup>	ETN50 + DMARD	24 weeks	64	1.5 (0.68)	0.9 (NR)	-0.6 (0.66)	NR
GO-FORTH <sup>91</sup>	PBO every 4 weeks + MTX 6–8 mg/week	14 weeks (primary end point)	88	1.0 (0.68)	0.93 (NR)	0.07 (0.49)	NR
GO-FORTH <sup>91</sup>	GOL 50 mg s.c. every 4 weeks + MTX 6–8 mg/week	14 weeks (primary end point)	86	1.0 (0.61)	0.68 (NR)	0.32 (0.40)	NR

continued

TABLE 352 Health Assessment Questionnaire Disability Index: populations 2 and 3 vs. DMARD(s) or PBO (continued)

Trial name/ author, year	Treatment arms for which data extraction performed	Assessment time point	n analysed	Mean HAQ-DI score at baseline (range 0–3) (SD)	Mean HAQ-DI score at follow-up (range 0–3) (SD)	HAQ-DI mean change from baseline (SD)	% change from baseline
GO-FORTH <sup>91</sup>	PBO every 4 weeks + MTX 6–8 mg/week	24 weeks (study RCT end point)	88	1.0 (0.68)	0.97 (NR)	0.03 (0.58)	NR
GO-FORTH <sup>91</sup>	GOL 50 mg s.c. every 4 weeks + MTX 6–8 mg/week	24 weeks (study RCT end point)	86	1.0 (0.61)	0.67 (NR)	0.33 (0.42)	NR
GO-FORWARD <sup>320</sup>	PBO s.c. every 4 weeks + MTX	14 weeks	133	1.3 (0.7)	1.14 (NR)	-0.16 (0.49)	NR
				1.250 (0.750–1.750) <sup>d</sup>		-0.13 (-0.38 to 0.13) <sup>d</sup>	
GO-FORWARD <sup>92</sup>	GOL 50 mg s.c. every 4 weeks + MTX	14 weeks	89	1.4 (0.7)	NR	-0.42 (0.50) ( <i>p</i> < 0.001 vs. PBO)	NR
				1.375 (1.000–1.875) <sup>d</sup>		-0.38 (-0.75 to - 0.13) <sup>d</sup> (a vs. PBO+MTX)	
GO-FORWARD <sup>92</sup>	PBO s.c. every 4 weeks + MTX	24 weeks	133	1.3 (0.7)	NR	-0.13 (0.58)	NR
				(0.750–1.750) <sup>d</sup>		-0.13 (-0.38 to 0.13) <sup>d</sup>	
GO-FORWARD <sup>92</sup>	GOL 50 mg s.c. every 4 weeks + MTX	24 weeks	89	1.4 (0.7)	NR	-0.47 (0.55) ( <i>p</i> < 0.001 vs. PBO)	NR
				(1.000–1.875) <sup>d</sup>		-0.38 (-0.75 to - 0.13) <sup>d</sup> (a vs. PBO+MTX)	
ATTRACT <sup>75</sup>	PBO i.v. + MTX	30 weeks	88	HAQ (0–3) 1.8 (1.3–2.1) <sup>d</sup>	HAQ (0–3) 1.5 (1.0–2.0) <sup>d</sup>	-0.3 (NR)	-3
ATTRACT <sup>75</sup>	IFX 3 mg/kg i.v. at weeks 0, 2 and 6 and every 8 weeks thereafter	30 weeks	86	HAQ (0–3) 1.8 (1.4–2.3) <sup>d</sup>	HAQ (0–3) 1.5 (0.9–2.1) <sup>d</sup>	-0.3 (NR)	-13 ( <i>p</i> = 0.167)
ATTRACT <sup>159</sup>	PBO i.v. + MTX	54 week	68	1.8 (1.3–2.1) <sup>d</sup>	1.8 (NR)	HAQ change 0 <sup>d</sup> (range 0.0–2.2)	% achieving HAQ change ≥ 0.25 = 43
ATTRACT <sup>75</sup>	IFX 3 mg/kg i.v. at weeks 0, 2 and 6 and every 8 weeks thereafter	54 week	77	HAQ 1.8 (1.4–2.3) <sup>d</sup>	1.4 (NR)	HAQ -0.4 <sup>d</sup> (range 0.0–1.9)	% achieving HAQ change ≥ 0.25 = 69 <sup>a</sup>

Trial name/ author, year	Treatment arms for which data extraction performed	Assessment time point	<i>n</i> analysed	Mean HAQ-DI score at baseline (range 0–3) (SD)	Mean HAQ-DI score at follow-up (range 0–3) (SD)	HAQ-DI mean change from baseline (SD)	% change from baseline
Durez <i>et al.</i> , 2004 <sup>86</sup>	Single i.v. infusion of 1-g MP at week 0 + MTX ( <i>n</i> = 15 randomised)	14 weeks	NR	HAQ 1.5 (0.75–2.13) <sup>d</sup>	1.55	0.05 (NR)	NR
Durez <i>et al.</i> , 2004 <sup>86</sup>	IFX 3 mg/kg at weeks 0, 2 and 6 + MTX ( <i>n</i> = 12 randomised)	14 weeks	NR	HAQ 1.3 (0.75–2) <sup>d</sup>	0.95 <sup>c</sup>	–0.35 (NR)	NR
START <sup>118</sup>	PBO + MTX	22 weeks (primary end point and study RCT end point)	363	1.5 (1–2) <sup>d</sup>	1.39 (NR)	–0.11	NR
START <sup>118</sup>	IFX 3 mg/kg + MTX	22 weeks (primary end point and study RCT end point)	360	1.5 (1–2) <sup>d</sup>	1.11 (NR)	–0.39	NR
Zhang <i>et al.</i> , 2006 <sup>126</sup>	PBO i.v. + MTX ( <i>n</i> = 86 randomised, <i>n</i> = 71 completed)	18 weeks	NR	NR	NR	HAQ score decreased by 0.45 (unclear whether or not mean value reported)	NR
Zhang <i>et al.</i> , 2006 <sup>126</sup>	IFX 3 mg/kg i.v. at weeks 0, 2, 6 and 14 + MTX ( <i>n</i> = 87 randomised, <i>n</i> = 78 completed)	18 weeks	NR	NR	NR	HAQ score decreased by 0.76 (unclear whether or not mean value reported) <sup>a</sup>	NR
ACT-RAY <sup>57</sup>	TCZ 8 mg/kg i.v. every 4 weeks + oral PBO	24 weeks	276	1.48 (0.60)	NR	–0.54	NR
ACT-RAY <sup>57</sup>	TCZ 8 mg/kg i.v. every 4 weeks + MTX	24 weeks	277	1.46 (0.66)	NR	–0.56	NR
TOWARD <sup>121</sup>	PBO i.v. every 4 weeks + stable cDMARDs ( <i>n</i> = 415 randomised)	24 weeks	413	1.5 (0.6)	1.3 (NR)	–0.2	% achieving ≥ 0.3 change from baseline = 34
TOWARD <sup>121</sup>	TCZ 8 mg/kg i.v. every 4 weeks + stable DMARDs ( <i>n</i> = 805 randomised)	24 weeks	803	1.5 (0.6)	1.0 (NR)	–0.5 <sup>a</sup>	% achieving ≥ 0.3 change from baseline = 60

continued

TABLE 352 Health Assessment Questionnaire Disability Index: populations 2 and 3 vs. DMARD(s) or PBO (continued)

Trial name/ author, year	Treatment arms for which data extraction performed	Assessment time point	n analysed	Mean HAQ-DI score at baseline (range 0–3) (SD)	Mean HAQ-DI score at follow-up (range 0–3) (SD)	HAQ-DI mean change from baseline (SD)	% change from baseline
TACIT <sup>141</sup>	Combination cDMARDs	AiC information has been removed	AiC information has been removed	AiC information has been removed	AiC information has been removed	AiC information has been removed	NR
TACIT <sup>141</sup>	TNF inhibitor + DMARD	AiC information has been removed	AiC information has been removed	AiC information has been removed	AiC information has been removed	AiC information has been removed	NR

AIM, Abatacept in Inadequate responders to Methotrexate; ASSURE, Abatacept Study of Safety in Use with other RA Therapies; CHANGE, Clinical investigation in Highly disease-affected rheumatoid Arthritis patients in Japan with Adalimumab applying standard and General Evaluation study; CREATE IIb, A 6-month Randomised, Double-blind, Open Arm Comparator, Phase IIb, With AZD9056, in Patients With Rheumatoid Arthritis (RA); ETN50, etanercept 50 mg once a week subcutaneously; NR, not reported; REALISTIC, RA Evaluation In Subjects receiving TNF Inhibitor Certolizumab pegol.

ABT i.v. = BT ≈10 mg/kg intravenously on weeks 0, 2 and 4, and every 4 weeks thereafter.

ABT s.c. = ABT 125 mg once per week subcutaneously, following an optional i.v. loading dose of ≈10 mg/kg based on weight range.

ADA = ADA 40 mg every other week subcutaneously.

CTZ = s.c. CTZ 400 mg at weeks 1, 2 and 4, then 200 mg every other week.

ETN = ETN 25 mg twice a week subcutaneously.

GOL = GOL 50 mg every 4 weeks subcutaneously.

IFX = IFX 3 mg/kg intravenously at weeks 0, 2, 6 and every 8 weeks thereafter (with dose escalation permitted after week 12 if lack of response).

TCZ = TCZ 8 mg/kg intravenously every 4 weeks.

a  $p < 0.01$ .

b Post-hoc analysis ( $p$ -value NR).

c  $p < 0.05$ .

d Median (interquartile range).

Data are shown to the level of accuracy available in the source material.

TABLE 353 Joint counts and assessment of inflammation markers: population 1 RCTs of biologic vs. DMARD(s) or PBO

Trial name/ study	Treatment arms for which data extraction performed	Assessment time point	Mean swollen joint count at baseline (SD) (scale)	Mean swollen joint count at follow-up (SD) (scale)	Swollen joint count % change from baseline	Mean tender joint count at baseline (SD) (scale)	Mean tender joint count at follow-up (SD) (scale)	Tender joint count % change from baseline	CRP level at baseline (mean) (mg/dl)	CRP level at follow-up (mean) (mg/dl)	ESR level at baseline (mean) (mm/hour)	ESR level at follow-up (mean) (mm/hour)
HIT HARD <sup>94</sup>	MTX + PBO	24 weeks	10.7 (4.5) (0–28 scale)	3.6 (4.9) (0–28 scale)	NR	13.1 (5.9) (0–28 scale)	5.0 (6) (0–28 scale)	NR	17 (7–34) <sup>a</sup>	7.1 (8.1)	36 (29–55) <sup>a</sup>	18.7 (14.2)
	ADA + MTX	24 weeks	10.2 (5.0) (0–28 scale)	1.4 (2.2) <sup>b</sup> (0–28 scale)	NR	13.0 (6.5) (0–28 scale)	3.2 (4.8) <sup>c</sup> (0–28 scale)	NR	12 (6–37) <sup>a</sup>	5.7 (10.3)	33 (29–45) <sup>a</sup>	16.1 (13.3)
OPERA <sup>107</sup>	MTX + PBO + steroid	12 months	11 (3, 31) <sup>d</sup>	0 (0, 3) <sup>d</sup>	NR	16 (6, 34) <sup>d</sup>	0 (0, 9) <sup>d</sup>	NR	15 (7, 109) <sup>d</sup>	7 (7, 44) <sup>d</sup>	NR	NR
	ADA + MTX + steroid	12 months	10 (3, 33) <sup>d</sup>	0 (0, 6) <sup>d</sup>	NR	15 (5, 38) <sup>d</sup>	0 (0, 13) <sup>d</sup>	NR	15 (7, 133) <sup>d</sup>	7 (7, 21) <sup>d</sup>	NR	NR
OPTIMA <sup>108</sup>	MTX + PBO	26 weeks	12 (5.8) (0–28 scale)	5.8 (0–28 scale)	NR	16 (6.7) (0–28 scale)	7.6 (0–28 scale)	NR	30 (33)	11.7	NR	NR
	ADA + MTX	26 weeks	18 (11) (0–66 scale)	3.6 (0–28 scale)	NR	27 (15) (0–68 scale)	5.3 <sup>c</sup> (0–28 scale)	NR	27 (32)	7.1 <sup>c</sup>	NR	NR
PREMIER <sup>311</sup>	MTX + PBO	1 year	22.1 (11.7) (0–66 scale)	NR	NR	32.3 (14.3) (0–68 scale)	NR	NR	4.0 (4.0)	NR	NR	NR
	ADA monotherapy + PBO step-up week 16	1 year	21.8 (10.5) (0–66 scale)	NR	NR	31.8 (13.6) (0–68 scale)	NR	NR	4.1 (3.9)	NR	NR	NR
	ADA + MTX step-up week 16	1 year	21.1 (11.2) (0–66 scale)	NR	NR	30.7 (14.2) (0–68 scale)	NR	NR	3.9 (4.2)	NR	NR	NR
PREMIER <sup>311</sup>	MTX + PBO	2 years	22.1 (11.7) (0–66 scale)	NR	NR	32.3 (14.3) (0–68 scale)	NR	NR	4.0 (4.0)	NR	NR	NR
	ADA monotherapy + PBO step-up week 16	2 years	21.8 (10.5) (0–66 scale)	NR	NR	31.8 (13.6) (0–68 scale)	NR	NR	4.1 (3.9)	NR	NR	NR
	ADA + MTX step-up week 16	2 years	21.1 (11.2) (0–66 scale)	NR	NR	30.7 (14.2) (0–68 scale)	NR	NR	3.9 (4.2)	NR	NR	NR

continued

**TABLE 353** Joint counts and assessment of inflammation markers: population 1 RCTs of biologic vs. DMARD(s) or PBO (continued)

Trial name/ study	Treatment arms for which data extraction performed	Assessment time point	Mean swollen joint count at baseline (SD) (scale)	Mean swollen joint count at follow-up (SD) (scale)	Swollen joint count % change from baseline	Mean tender joint count at baseline (SD) (scale)	Mean tender joint count at follow-up (SD) (scale)	Tender joint count % change from baseline	CRP level at baseline (mean) (mg/dl)	CRP level follow-up (mean) (mg/dl)	ESR level at baseline (mean) (mm/hour)	ESR level at follow-up (mean) (mm/hour)
COMET <sup>82</sup>	MTX + PBO (n = 268)	52 weeks	Mean DAS28 swollen joint count 12.3	4.3	65% improvement	NR	NR	NR	NR	NR	NR	NR
	ETN + MTX (n = 274)		12.4	1.8	85% improvement <sup>c</sup>	NR	NR	NR	NR	NR	NR	NR
COMET <sup>82</sup>	MTX in year 1, MTX in year 2	From week 52 to week 104	2.4	2.9	NR	NR	NR	NR	NR	NR	NR	NR
	n = 99 at start of period 2											
	MTX in year 1, ETN + MTX in year 2		2.6	1.3 <sup>b</sup> (vs. MTX year 1 and MTX year 2)	NR	NR	NR	NR	NR	NR	NR	NR
	n = 90 at start of period 2											
COMET <sup>81</sup>	ETN + MTX in year 1, ETN + MTX in year 2		1.7	1.3	NR	NR	NR	NR	NR	NR	NR	NR
	n = 111 at start of period 2											
	ETN + MTX in year 1, ETN in year 2		1.1	1.7	NR	NR	NR	NR	NR	NR	NR	NR
	n = 111 at start of period 2											
ERA <sup>321</sup>	MTX + PBO	6 months	24 (11.9)	NR	NR	30 (16.1)	NR	NR	3.7	NR	NR	NR
	ETN 25 mg every 2 weeks + PBO	6 months	24 (11.9)	NR	NR	31 (15.8)	NR	NR	3.3	NR	NR	NR
ERA <sup>321</sup>	MTX + PBO	12 months	24 (11.9)	NR	NR	30 (16.1)	NR	NR	NR	NR	NR	NR
	ETN 25 mg every 2 weeks + PBO	12 months	24 (11.9)	NR	NR	31 (15.8)	NR	NR	NR	NR	NR	NR

Trial name/ study	Treatment arms for which data extraction performed	Assessment time point	Mean swollen joint count at baseline (SD) (scale)	Mean swollen joint count at follow-up (SD) (scale)	Swollen joint count % change from baseline	Mean tender joint count at baseline (SD) (scale)	Mean tender joint count at follow-up (SD) (scale)	Mean tender joint count at follow-up (SD) (scale)	Tender joint count % change from baseline	CRP level at baseline (mean) (mg/dl)	CRP level at follow-up (mean) (mg/dl)	ESR level at baseline (mean) (mm/hour)	ESR level at follow-up (mean) (mm/hour)
GO-BEFORE <sup>30</sup>	PBO + MTX	24 weeks	(0–66)	NR	66.7 <sup>a</sup>	(0–68)	NR	NR	57.1 <sup>a</sup>	2.6 (3.28)	NR	NR	NR
			14.9 (10.01)			27.3 (16.16)							
	GOL 50 mg s.c. every 4 weeks + MTX	24 weeks	16.0 (9.98)	NR	75.6 <sup>a</sup>	29.2 (17.05)	NR	NR	67.2 <sup>a,c</sup>	2.4 (3.02)	NR	NR	NR
Durez <i>et al.</i> , 2007 <sup>120</sup>	MTX	52 weeks (study RCT end point)	10.3 (5.5)	NR	NR	11.6 (7.5)	NR	NR	NR	2.5 (3.5)	2.5 (1–31) <sup>a</sup>	NR	NR
	MTX + i.v. MP	52 weeks (study RCT end point)	12.4 (7.6)	NR	NR	13.2 (9.1)	NR	NR	NR	4.7 (5.1)	7.5 (1–27) <sup>a</sup>	NR	NR
			12.5 (5.4)	NR	NR	15.9 (8.0)	NR	NR	NR	32 (3–213) <sup>a</sup>	3.5 (1–29) <sup>a</sup>	NR	NR
Quinn <i>et al.</i> , 2005 <sup>110</sup>	MTX + PBO	14 weeks	NR	NR	NR	NR	NR	NR	NR	37 (38.8)	41 <sup>e</sup>	NR	NR
	IFX 3 mg/kg + MTX	14 weeks	NR	NR	NR	NR	NR	NR	NR	47 (27.9)	7 <sup>e</sup>	NR	NR
Quinn <i>et al.</i> , 2005 <sup>110</sup>	MTX + PBO	54 weeks	NR	NR	NR	NR	NR	NR	NR	37 (38.8)	10 <sup>e</sup>	NR	NR
	IFX 3 mg/kg + MTX	54 weeks	NR	NR	NR	NR	NR	NR	NR	47 (27.9)	8 <sup>e</sup>	NR	NR

ERA, Early Rheumatoid Arthritis (etanercept); HIT HARD, High Induction Therapy with Anti-Rheumatic Drugs (adalimumab and methotrexate); NR, not reported; OPTIMA, OPTimal protocol for treatment initiation with Methotrexate and Adalimumab.  
 ABT s.c. = ABT 125 mg once per week subcutaneously, following an optional i.v. loading dose of ≈10 mg/kg based on weight range.  
 ADA = ADA 40 mg every other week subcutaneously.  
 ETN = ETN 25 mg twice a week subcutaneously.  
 IFX = IFX 3 mg/kg intravenously at weeks 0, 2, 6 and every 8 weeks thereafter (with dose escalation permitted after week 12 if lack of response).  
 TCZ = TCZ 8 mg/kg intravenously every 4 weeks.  
 a Median (interquartile range).  
 b  $p < 0.001$ .  
 c  $p < 0.05$ .  
 d Median (5th, 95th centile range).  
 e Estimated from graphical data.

TABLE 354 Joint counts and assessment of inflammation markers: populations 2 and 3 biologic head-to-head RCTs

Trial name/ study	Treatment arms for which data extraction performed	Assessment time point	Mean swollen joint count at baseline (SD) (scale)	Mean swollen joint count at follow-up (SD) (scale)	Swollen joint count % change from baseline	Mean tender joint count at baseline (SD) (scale)	Mean tender joint count at follow-up (SD) (scale)	Tender joint count % change from baseline	CRP level at baseline (mean) (mg/dl)	CRP level at follow-up (mean) (mg/dl)	ESR level at baseline (mean) (mm/hour)	ESR level at follow-up (mean) (mm/hour)
AMPLE <sup>66</sup>	ABT s.c. + MTX	1 year	15.8 (9.8) (0–66 scale)	NR	70.9 improved	25.4 (15.3) (0–68 scale)	NR	59.8 improved	1.6 (2.1)	0.80 (1.13)	NR	NR
	ADA + MTX	1 year	15.9 (10.0) (0–66 scale)	NR	68.2 improved	26.3 (15.8) (0–68 scale)	NR	61.4 improved	1.5 (2.8)	0.65 (1.21)	NR	NR
RED-SEA <sup>114</sup>	ADA + cDMARDs (n = 60)	12 months	(Scale 0–28) 9 (5–12) <sup>a</sup>	4 (1–6) <sup>a</sup>		(Scale 0–28) 14 (9–20) <sup>a</sup>	5 (1–14) <sup>a</sup>		10 (5–22) <sup>a</sup>	6 (3–14) <sup>a</sup>		
	ETN50 + cDMARDs (n = 60)		(Scale 0–28) 9 (6–13) <sup>a</sup>	5 (2–11) <sup>a</sup>		(Scale 0–28) 14 (8–20) <sup>a</sup>	8 (4–14) <sup>a</sup>		12.5 (5–31) <sup>a</sup>	9 (3–14) <sup>a</sup>		
deFilippis <i>et al.</i> , 2006 <sup>85</sup>	ETN + MTX	54 weeks	16.87 (7.31)	Conflicting data	49.5	22.40 (8.10)	Conflicting data	–61.3 <sup>b</sup>	NR	NR	35.47 (20.31)	Conflicting data
	IFX + MTX	54 weeks	14.73 (5.04)	Conflicting data	45.3	20.93 (9.97)	Conflicting data	–24.33	NR	NR	38 (26.28)	Conflicting data
ADACTA <sup>58</sup>	TCZ 8 mg/kg i.v. every 4 weeks + s.c. PBO ADA	24 weeks	(0–28 scale) 11.3 (5.3)	(0–66 scale) 6.7 (10.7)	NR	(0–28 scale) 15.9 (6.7)	(0–68 scale) 12.7 (SD NR)	NR	N/A	NR	N/A	NR
	ADA 40 mg s.c. every 2 weeks + i.v. PBO TCZ	24 weeks	12.4 (5.4)	8.6 (10.5)	NR	16.5 (7.0)	16.8 (16.2)	NR	N/A	NR	N/A	NR

ETN50, etanercept 50 mg once a week subcutaneously; N/A, not applicable; NR, not reported.

ABT s.c. = ABT 125 mg once per week subcutaneously, following an optional i.v. loading dose of ≈10 mg/kg based on weight range.

ADA = ADA 40 mg every other week subcutaneously.

ETN = ETN 25 mg twice a week subcutaneously.

GOL = GOL 50 mg every 4 weeks subcutaneously.

IFX = IFX 3 mg/kg intravenously at weeks 0, 2, 6 and every 8 weeks thereafter (with dose escalation permitted after week 12 if lack of response).

TCZ = TCZ 8 mg/kg intravenously every 4 weeks.

a Median (interquartile range).

b  $p < 0.05$ .



TABLE 355 Joint counts and assessment of inflammation markers: populations 2 and 3 RCTs of biologic vs. DMARD(s) or PBO

Trial name/ study	Treatment arms for which data extraction performed	Assessment time point	Mean swollen joint count at baseline (SD) (scale)	Mean swollen joint count at follow-up (SD) (scale)	Swollen joint count % change from baseline	Mean tender joint count at baseline (SD) (scale)	Mean tender joint count at follow-up (SD) (scale)	Tender joint count, n % change from baseline	CRP level at baseline (mean) (mg/dl)	CRP level at follow-up (mean) (mg/dl)	ESR level at baseline (mean) (mm/hour)	ESR level at follow-up (mean) (mm/hour)
AIM <sup>62</sup>	MTX + PBO (n = 219)	12 months	(Scale unclear)	NR	Adjusted mean change -11.5 (0.54)	(Scale unclear)	NR	Adjusted mean change -16.3 (0.85)	28 (25)	Adjusted mean change -8.2 (1.4)	NR	NR
	ABT i.v. + MTX (n = 433)		22.1 (8.8)	NR	Adjusted mean change -16.1 (0.35)	32.3 (13.6)	NR	Adjusted mean change -22.5 (0.55)	33 (31)	Adjusted mean change -18.3 (0.9)	NR	NR
ASSET <sup>72</sup>	PBO + MTX	4 months	8.5 (4.1)	NR	NR	13.3 (7.2)	NR	NR	16.6 (16.8)	NR	NR	NR
	ABT i.v. (≈ 10 mg/kg) + MTX	4 months	(Scale NR)	NR	NR	(Scale NR)	NR	NR	13.6 (17.4)	NR	NR	NR
CHANGE <sup>60</sup>	PBO (n = 87)	24 weeks	11.3 (6.6)	NR	Mean change -1.8 (7.4)	12.9 (7.1)	NR	Mean change -0.5 (10.9)	5.9 (3.3)	Mean change 0.1 (3.2)	NR	NR
	ADA monotherapy (n = 91)		(Scale NR)	NR	Mean change -8.2 (8.8) <sup>a</sup>	(Scale NR)	NR	Mean change -10.7 (12.3) <sup>b</sup>	6.5 (4.4)	Mean change -1.6 (4.1) <sup>a</sup>	NR	NR
ADORE <sup>59,60</sup>	ETN monotherapy (n = 159)	16 weeks	19.3 (7)	NR	NR	23.7 (8.8)	NR	NR	NR	NR	NR	26.4
	n = 156 at 16 weeks		19.1 (7.3)	NR	NR	24.4 (10.7)	NR	NR	NR	NR	NR	20.8 <sup>b</sup>
	ETN + MTX (n = 155)		NR	NR	NR	NR	NR	NR	NR	NR	NR	NR
	n = 151 at 16 weeks		NR	NR	NR	NR	NR	NR	NR	NR	NR	NR

continued

**TABLE 355** Joint counts and assessment of inflammation markers: populations 2 and 3 RCTs of biologic vs. DMARD(s) or PBO (*continued*)

Trial name/ study	Treatment arms for which data extraction performed	Assessment time point	Mean swollen joint count at baseline (SD) (scale)	Mean swollen joint count at follow-up (SD) (scale)	Swollen joint count % change from baseline	Mean tender joint count at baseline (SD) (scale)	Mean tender joint count at follow-up (SD) (scale)	Tender joint count, n % change from baseline	CRP level at baseline (mean) (mg/dl)	CRP level at follow-up (mean) (mg/dl)	ESR level at baseline (mean) (mm/hour)	ESR level at follow-up (mean) (mm/hour)
ETN study 309 <sup>89</sup>	SSZ + PBO (n = 50)	24 weeks	(Scale unclear)	NR	38.5% improvement	Painful joints (scale unclear)	NR	Painful joints 22.7% improvement	NR	32.9 <sup>c</sup>	NR	0.2 <sup>d</sup>
	ETN + PBO (n = 103)		NR	NR	68.7% improvement	NR	NR	65.4% improvement	NR	69.9 <sup>a</sup> (vs. SSZ) <sup>c</sup>	NR	37.6 <sup>a</sup> (vs. SSZ) <sup>d</sup>
	ETN + SSZ (n = 101)		NR	NR	70.1% <sup>a</sup> vs. SSZ improvement	NR	NR	62.0% improvement	NR	66.7 <sup>a</sup> (vs. SSZ) <sup>c</sup>	NR	43.0 <sup>a</sup> (vs. SSZ) <sup>d</sup>
JESMR <sup>140</sup>	ETN 25 mg every 2 weeks monotherapy	24 weeks	12.4 (6.1) (0–66 scale)	4.3 (5.2)	NR	15.0 (9.4) (0–68 scale)	4.5 (8.0)	NR	2.5 (2.5)	1.2 (1.7)	59.7 (28.4)	41.6 (25.4)
	ETN 25 mg every 2 weeks + MTX 6–8 mg/week	24 weeks	12.5 (6.5) (0–66 scale)	3.0 (3.8)	NR	15.1 (8.1) (0–68 scale)	2.4 (3.9)	NR	3.0 (3.2)	0.6 (1.0) <sup>a</sup>	59.5 (26.5)	29.9 (23.3) <sup>a</sup>
JESMR <sup>140</sup>	ETN 25 mg every 2 weeks monotherapy	52 weeks	12.4 (6.1) (0–66 scale)	4.0 (4.4)	NR	15.0 (9.4) (0–68 scale)	4.3 (5.3)	NR	2.5 (2.5)	1.3 (1.6)	59.7 (28.4)	43.7 (27.0)
	ETN 25 mg every 2 weeks + MTX 6–8 mg/week	52 weeks	12.5 (6.5) (0–66 scale)	1.8 (2.3) <sup>a</sup>	NR	15.1 (8.1) (0–68 scale)	2.1 (2.8) <sup>a</sup>	NR	3.0 (3.2)	3.0 (3.2) <sup>b</sup>	59.5 (26.5)	28.9 (23.8) <sup>b</sup>
Lan et al., 2004 <sup>101</sup>	PBO + MTX	12 weeks	14.45 (0–28 scale)	10.59 (0–28 scale)	27	16.00 (0–28 scale)	13.55 (0–28 scale)	15	1.83	1.38	NR	NR
	ETN 25 mg twice weekly + MTX	12 weeks	13.21 (0–28 scale)	4.66 <sup>a</sup> (0–28 scale)	65	14.03 (0–28 scale)	7.03 <sup>a</sup> (0–28 scale)	50	1.65	0.39 <sup>a</sup>	NR	NR
LARA <sup>102</sup>	MTX + DMARD (n = 142)	24 weeks	(Scale unclear)	NR	-8.6 (0.6) <sup>e</sup>	(Scale unclear)	NR	-12.8 (0.8) <sup>e</sup>	NR	NR	NR	NR
	ETN50 + MTX (n = 281)		19.3 (10.1)	NR	-15.1 (0.4) <sup>a,e</sup>	26.2 (12.3)	NR	-19.8 (0.6) <sup>a,e</sup>	NR	NR	NR	NR
			18.2 (8.4)	NR		25.1 (11.9)	NR		NR	NR	NR	NR

n = 279 at week 24

Trial name/ study	Treatment arms for which data extraction performed	Assessment time point	Mean swollen joint count at baseline (SD) (scale)	Mean swollen joint count at follow-up (SD) (scale)	Swollen joint count % change from baseline	Mean tender joint count at baseline (SD) (scale)	Mean tender joint count at follow-up (SD) (scale)	Tender joint count, n % change from baseline	CRP level at baseline (mean) (mg/dl)	CRP level at follow-up (mean) (mg/dl)	ESR level at baseline (mean) (mm/hour)	ESR level at follow-up (mean) (mm/hour)
Moreland <i>et al.</i> , 1999 <sup>104</sup>	PBO (n = 80)	6 months	(Scale 0–68)	NR	7% (worsening)	(Scale 0–71)	NR	–6%	4.1	207% worse <sup>d</sup>	39	18% worse <sup>d</sup>
	ETN + PBO (n = 78)		25	NR	–47 <sup>b</sup>	35	NR	–56% <sup>a</sup>	4.7	31% improved <sup>b,d</sup>	35	18% improved <sup>b,d</sup>
RACAT <sup>111</sup>	MTX + SSZ + HCQ (n = 178; not all analysed)	24 weeks	(Scale 0–28)	5.32 (4.73)	NR	(Scale 0–28)	5.87 (5.96)	NR	NR	NR	27.39 (21.03)	20.38 (16.73)
	ETN50 + MTX (n = 175; not all analysed)		11.12 (5.26)	4.76 (5.14)	NR	(Scale 0–28)	5.94 (6.85)	NR	NR	NR	29.80 (23.51)	Change 0.97 (0.85)
RACAT <sup>111</sup>	MTX + SSZ + HCQ (n = 178; not all analysed, some switched)	48 weeks (n = 310 both groups)	NR	NR	3.93 (4.19)	NR	4.64 (5.61)	NR	NR	NR	NR	19.01 (17.89)
	ETN50 + MTX (n = 175; not all analysed, some switched)		11.34 (5.22)	4.76 (5.14)	NR	(Scale 0–28)	5.94 (6.85)	NR	NR	NR	NR	Change 0.98 (0.87)
Weinblatt <i>et al.</i> , 1999 <sup>124</sup>	MTX + PBO, (n = 30)	24 weeks	(Scale 0–68)	16 <sup>f</sup>	NR	(Scale 0–71)	17 <sup>f</sup>	NR	2.6 <sup>f</sup>	1.6 <sup>f</sup>	36 <sup>f</sup>	30 <sup>f</sup>
	ETN 25 mg twice weekly + MTX (n = 59)		17 <sup>f</sup>	6 <sup>b,f</sup>	NR	28 <sup>c</sup>	7 <sup>b,f</sup>	NR	2.2 <sup>c</sup>	0.5 <sup>b,f</sup>	25 <sup>c</sup>	15 <sup>a,f</sup>
APEAL <sup>67,68</sup>	MTX + DMARD (SSZ, HCQ or LEF)	16 weeks	NR	NR	NR	NR	NR	NR	2.06 (2.48) calculated from 20.6 (24.8)	9.8 (52.2)	54.80 (28.2)	40.4 (26.2)
	ETN 25 mg twice weekly (licensed dose) + MTX	16 weeks	NR	NR	NR	NR	NR	NR	1.70 (2.10) calculated from 17.0 (21.0)	7.9 (53.3)	57.7 (33.0)	34.4 (40.4) <sup>p</sup>

continued

**TABLE 355** Joint counts and assessment of inflammation markers: populations 2 and 3 RCTs of biologic vs. DMARD(s) or PBO (continued)

Trial name/ study	Treatment arms for which data extraction performed	Assessment time point	Mean swollen joint count at baseline (SD) (scale)	Mean swollen joint count at follow-up (SD) (scale)	Swollen joint count % change from baseline	Mean tender joint count at baseline (SD) (scale)	Mean tender joint follow-up (SD) (scale)	Tender joint count, n % change from baseline	CRP level at baseline (mean) (mg/dl)	CRP level at follow-up (mean) (mg/dl)	ESR level at baseline (mean) (mm/hour)	ESR level at follow-up (mean) (mm/hour)
GO-FORTH <sup>91</sup>	PBO every 4 weeks + MTX 6–8 mg/week	14 weeks	11.4 (6.58)	NR	NR	13.2 (7.83)	NR	NR	NR	NR	NR	NR
			(0–66 scale)	(0–68 scale)								
GO-FORTH <sup>91</sup>	GOL 50 mg s.c. every 4 weeks + MTX 6–8 mg/week	14 weeks	11.8 (6.72)	NR	NR	13.1 (8.38)	NR	NR	NR	NR	NR	NR
			(0–66 scale)	(0–68 scale)								
GO-FORTH <sup>91</sup>	PBO every 4 weeks + MTX 6–8 mg/week	24 weeks	11.4 (6.58)	NR	NR	13.2 (7.83)	NR	NR	NR	NR	NR	NR
			(0–66 scale)	(0–68 scale)								
GO-FORTH <sup>91</sup>	GOL 50 mg s.c. every 4 weeks + MTX 6–8 mg/week	24 weeks	11.8 (6.72)	NR	NR	13.1 (8.38)	NR	NR	NR	NR	NR	NR
			(0–66 scale)	(0–68 scale)								
GO-FORWARD <sup>92</sup>	PBO s.c. every 4 weeks + MTX	Week 14	12.0 (8.0–19.0) <sup>f</sup>	NR	37.5 (0.0–71.4) <sup>f</sup>	21.0 (14.0–34.0) <sup>f</sup>	NR	30.0 (–12.1 to 66.7) <sup>f</sup>	0.8 (0.3–2.0) <sup>f</sup>	NR	NR	NR
			(0–66 scale)	As reported	(0–68 scale)	As reported						
GO-FORWARD <sup>92</sup>	GOL 50 mg s.c. every 4 weeks + MTX	Week 14	13.0 (8.0–22.0) <sup>f</sup>	NR	62.1 (28.6–84.6) <sup>b,f</sup>	26.0 (16.0–39.0) <sup>f</sup>	NR	59.5 (24.0–77.8) <sup>b,f</sup>	1.00 (0.40–2.80) <sup>f</sup>	NR	NR	NR
			(0–66 scale)	As reported	(0–68 scale)	As reported						
GO-FORWARD <sup>92</sup>	PBO s.c. every 4 weeks + MTX	Week 24	12.0 (8.0–19.0) <sup>f</sup>	NR	32.1 (–9.1 to 71.4) <sup>f</sup>	21.0 (14.0–34.0) <sup>f</sup>	NR	20.9 (–13.3 to 64.3) <sup>f</sup>	NR	NR	NR	NR
			(0–66 scale)	As reported	(0–68 scale)	As reported						
ATTRACT <sup>75</sup>	PBO i.v. + MTX	30 weeks	(0–66)	13 (8–26) <sup>f</sup>	–20	As reported	NR	61.6 (18.7–85.4) <sup>f</sup>	NR	NR	NR	NR
			19 (13–28) <sup>f</sup>	As reported	(0–68)	16 (7–33) <sup>f</sup>	–26	3.0 (1.2–5.7) <sup>f</sup>	2.3 (0.7–5.1) <sup>f</sup> (–9% change)	NR	NR	NR
ATTRACT <sup>75</sup>	IFX 3 mg/kg i.v. at weeks 0, 2 and 6 and every 8 weeks thereafter	30 weeks	(0–66)	9 (4–18) <sup>b,f</sup>	–52 <sup>b</sup>	As reported	NR	–59 <sup>a</sup>	3.1 (1.3–5.3) <sup>f</sup>	0.8 (0.4–2.3) <sup>b,f</sup> (–60% change) <sup>b</sup>	NR	NR
			19 (13–30) <sup>f</sup>	As reported	(0–68)	12 (3–21) <sup>b,f</sup>	–59 <sup>a</sup>	3.1 (1.3–5.3) <sup>f</sup>	0.8 (0.4–2.3) <sup>b,f</sup> (–60% change) <sup>b</sup>	NR	NR	NR

Trial name/ study	Treatment arms for which data extraction performed	Assessment time point	Mean swollen joint count at baseline (SD) (scale)	Mean swollen joint count at follow-up (SD) (scale)	Swollen joint count % change from baseline	Mean tender joint count at baseline (SD) (scale)	Mean tender joint count at follow-up (SD) (scale)	Tender joint count, n % change from baseline	CRP level at baseline (mean) (mg/dl)	CRP level at follow-up (mean) (mg/dl)	ESR level at baseline (mean) (mm/hour)	ESR level at follow-up (mean) (mm/hour)
ATTRACT <sup>146</sup>	PBO i.v. + MTX	54 week	(0-66)	NR	13 (61) <sup>g</sup>	(0-68)	NR	23 (63) <sup>g</sup>	N/A	NR	NR	NR
			19 (13-28) <sup>f</sup>		As reported	24 (16-48) <sup>f</sup>		As reported				
	IFX 3 mg/kg i.v. at weeks 0, 2 and 6 and every 8 weeks thereafter	54 week	(0-66)	NR	37 (62) <sup>b,g</sup>	(0-68)	NR	49 (52) <sup>b,g</sup>	N/A	NR	NR	NR
			19 (13-30) <sup>f</sup>		As reported	32 (16-46) <sup>f</sup>		As reported				
Durez et al., 2004 <sup>16</sup>	Single i.v. infusion of 1-g MP at week 0 + MTX (n = 15 randomised)	14 weeks	22 (7-38) <sup>h</sup>	22	NR	24 (7-38) <sup>h</sup>	20	NR	1.9 <sup>h</sup>	2.0	NR	NR
			(0-66 scale)			(0-68 scale)						
	IFX 3 mg/kg at weeks 0, 2 and 6 + MTX (n = 12 randomised)	14 weeks	16 (8-27) <sup>h</sup>	7 <sup>b</sup>	NR	20 (6-44) <sup>h</sup>	8 <sup>a</sup>	NR	1.3 <sup>h</sup>	0.9	NR	NR
			(0-66 scale)			(0-68 scale)						
START <sup>118</sup>	PBO + MTX	22 weeks	15 (10-21) <sup>f</sup>	NR	NR	22 (15-32) <sup>f</sup>	NR	NR	1.2 (1-3) <sup>f</sup>	NR	NR	NR
			(0-66 scale)			(0-68 scale)						
	IFX 3 mg/kg + MTX	22 weeks	15 (11-21) <sup>f</sup>	NR	NR	22 (15-31) <sup>f</sup>	NR	NR	1.6 (1-3) <sup>f</sup>	NR	NR	NR
			(0-66 scale)			(0-68 scale)						
Wong et al., 2009 <sup>25</sup>	PBO + MTX (with crossover for PBO group to open-label IFX at week 24)	Week 16	(0-28 scale)	12	NR	(0-28 scale)	16	NR	3.0	22	40 (24)	37
			12 (5)			15 (7)						
	IFX 3 mg/kg at weeks 0, 2, 6 and 8 weeks thereafter + MTX	Week 16	10 (5)	4	NR	14 (7)	8 <sup>a</sup>	NR	3.2	12	39 (26)	26
ACT-RAY <sup>57</sup>	TCZ 8 mg/kg i.v. every 4 weeks + oral PBO	Week 24	15.3 (10.2)	NR	-11.75 (9.45) <sup>g</sup>	26.6 (15.2)	NR	-17.00 (13.64) <sup>g</sup>	NR	NR	NR	NR
			(Scale NR)			(Scale NR)						
	TCZ 8 mg/kg i.v. every 4 weeks + MTX	Week 24	14.4 (8.9)	NR	-11.33 (8.04) <sup>g</sup>	25.8 (13.9)	NR	-17.25 (13.35) <sup>g</sup>	NR	NR	NR	NR
			(Scale NR)			(Scale NR)						

continued

TABLE 355 Joint counts and assessment of inflammation markers: populations 2 and 3 RCTs of biologic vs. DMARD(s) or PBO (continued)

Trial name/ study	Treatment arms for which data extraction performed	Assessment time point	Mean swollen joint count at baseline (SD) (scale)	Mean swollen joint count at follow-up (SD) (scale)	Swollen joint count % change from baseline	Mean tender joint count at baseline (SD) (scale)	Mean tender joint count at follow-up (SD) (scale)	Tender joint count, n % change from baseline	CRP level at baseline (mean) (mg/dl)	CRP level at follow-up (mean) (mg/dl)	ESR level at baseline (mean) (mm/hour)	ESR level at follow-up (mean) (mm/hour)
SATOR <sup>322</sup>	PBO i.v. every 4 weeks + MTX	24 weeks	(0-28) 12 <sup>i</sup>	(0-28) 9 <sup>i</sup>	NR	(0-28) 10.5 <sup>i</sup>	(0-28) 7 <sup>i</sup>	NR	2.6 <sup>i</sup>	7 <sup>i</sup>	50 <sup>i</sup>	45 <sup>i</sup>
	TCZ 8 mg/kg i.v. every 4 weeks + PBO capsules	24 weeks	(0-28) 10 <sup>i</sup>	(0-28) 4.5 <sup>i</sup>	NR	(0-28) 10 <sup>i</sup>	(0-28) 2 <sup>i</sup>	NR	3.0 <sup>i</sup>	2 <sup>i</sup>	50 <sup>i</sup>	11 <sup>i</sup>
TOWARD <sup>121</sup>	PBO i.v. every 4 weeks + stable cDMARDs (n = 415 randomised)	24 weeks	(0-68) 18.7 (10.8)	13.8	NR	(0-66) 29.1 (14.8)	20.6	NR	2.6 (4.7)	2.33	49.2 (28.3)	44.5
	TCZ 8 mg/kg i.v. every 4 weeks + stable DMARDs (n = 805 randomised)	24 weeks	19.7 (11.6)	9.4 <sup>b</sup>	NR	30.1 (16.0)	14.4 <sup>b</sup>	NR	2.6 (3.2)	0.4 <sup>b</sup>	48.2 (27.5)	12.6 <sup>b</sup>

Trial name/ study	Treatment arms for which data extraction performed	Assessment time point	Mean swollen joint count at baseline (SD) (scale)	Mean swollen joint count at follow-up (SD) (scale)	Swollen joint count % change from baseline	Mean tender joint count at baseline (SD) (scale)	Mean tender joint count at follow-up (SD) (scale)	Tender joint count, <i>n</i> change from baseline	CRP level at baseline (mean) (mg/dl)	CRP level at follow-up (mean) (mg/dl)	ESR level at baseline (mean) (mm/hour)	ESR level at follow-up (mean) (mm/hour)
TACIT <sup>141</sup>	Combination cDMARDs	AiC information has been removed	AiC information has been removed	AiC information has been removed	AiC information has been removed	AiC information has been removed	AiC information has been removed	AiC information has been removed	AiC information has been removed	AiC information has been removed	AiC information has been removed	AiC information has been removed
	TNF inhibitor + DMARD	AiC information has been removed	AiC information has been removed	AiC information has been removed	AiC information has been removed	AiC information has been removed	AiC information has been removed	AiC information has been removed	AiC information has been removed	AiC information has been removed	AiC information has been removed	AiC information has been removed

AIM, Abatacept in Inadequate responders to Methotrexate; ASSET, Abatacept Systemic SclErosis Trial; CHANGE, Clinical investigation in Highly disease-affected rheumatoid Arthritis patients in Japan with Adalimumab applying standard and General Evaluation study; ETN50, etanercept 50 mg once a week subcutaneously; N/A, not applicable; NR, not reported; SATORI, Study of Active controlled Tocilizumab for Rheumatoid arthritis patients with an Inadequate response to methotrexate.

ABT i.v. = BT ≈10 mg/kg intravenously on weeks 0, 2 and 4, and every 4 weeks thereafter.

ABT s.c. = ABT 125 mg once per week subcutaneously, following an optional i.v. loading dose of ≈10 mg/kg based on weight range.

ADA = ADA 40 mg every other week subcutaneously.

CTZ = s.c. CTZ 400 mg at weeks 1, 2 and 4, then 200 mg every other week.

ETN = ETN 25 mg twice a week subcutaneously.

GOL = GOL 50 mg every 4 weeks subcutaneously.

IFX = IFX 3 mg/kg intravenously at weeks 0, 2, 6 and every 8 weeks thereafter (with dose escalation permitted after week 12 if lack of response).

TCZ = TCZ 8 mg/kg intravenously every 4 weeks.

a  $p < 0.05$ .

b  $p < 0.001$ .

c Median % change.

d Mean % change.

e Adjusted mean change (SE).

f Median (interquartile range).

g Mean change (SD).

h Median (range).

i Estimated from graphical data.

Data are shown to the level of accuracy available in the source material.

TABLE 356 Global assessments of disease activity: population 1 RCTs of biologic vs. DMARD(s) or PBO

Trial name/ study	Treatment arms for which data extraction performed	Assessment time point	Patient's global assessment of disease activity at baseline <sup>a</sup>	Patient's global assessment of disease activity at follow-up <sup>a</sup>	% change from baseline	Evaluator's global assessment of disease activity at baseline <sup>a</sup>	Evaluator's global assessment of disease activity at follow-up <sup>a</sup>	% change from baseline
OPERA <sup>107</sup>	PBO + MTX + steroid	12 months	65 (17–96) <sup>b</sup>	18 (0–69) <sup>b</sup>	NR	51 (22–86) <sup>b</sup>	4 (0–33) <sup>b</sup>	NR
	ADA + MTX + steroid	12 months	70 (12–100) <sup>b</sup>	10 (0–54) <sup>b</sup>	NR	57 (22–86) <sup>b</sup>	1 (0–59) <sup>b</sup>	NR
OPTIMA <sup>108</sup>	PBO + MTX	26 weeks	63 (22)	35.1	NR	62 (18)	28.9	NR
	ADA + MTX	26 weeks	64 (23)	26.4	NR	63 (18)	21.3	NR
GO-BEFORE <sup>90</sup>	PBO + MTX	24 weeks	(0–10 scale)	NR	–36.70	(0–10 scale)	NR	–63.00
			5.9 (2.32)			6.0 (1.72)		
	GOL + MTX	24 weeks	(0–10 scale)	NR	–49.55 <sup>c</sup>	(0–10 scale)	NR	–66.70
			6.1 (2.21)			6.2 (1.63)		



Trial name/ study	Treatment arms for which data extraction performed	Assessment time point	Patient's global assessment of disease activity at baseline <sup>a</sup>	Patient's global assessment of disease activity at follow-up <sup>a</sup>	% change from baseline	Evaluator's global assessment of disease activity at baseline <sup>a</sup>	Evaluator's global assessment of disease activity at follow-up <sup>a</sup>	% change from baseline
BeST <sup>148</sup>	Sequential monotherapy	6 months	59.2	NR	Mean change from baseline = -22.3	NR	NR	NR
	Step-up combination therapy	6 months	59.4	NR	Mean change from baseline = -28.0	NR	NR	NR
	Initial combination therapy + prednisone	6 months	59.5	NR	Mean change from baseline = -32.0 <sup>c</sup> (for sequential monotherapy vs. initial combination + prednisone and initial combination + MTX)	NR	NR	NR
	Initial combination therapy + IFX	6 months	61.8	NR	Mean change from baseline = -35.9 <sup>c</sup> (for sequential monotherapy vs. initial combination + prednisone and initial combination + MTX)	NR	NR	NR

NR, not reported; OPTIMA, OPTimal protocol for treatment Initiation with Methotrexate and Adalimumab.  
 ADA = ADA 40 mg every other week subcutaneously.  
 GOL = GOL 50 mg every 4 weeks subcutaneously.  
 a Reported on 0–100 VAS scale unless otherwise stated.  
 b Median (interquartile range).  
 c  $p < 0.05$ .  
 Data are shown to the level of accuracy available in the source material.

TABLE 357 Global assessments of disease activity: populations 2 and 3 biologic head-to-head RCTs

Trial name/ study	Treatment arms for which data extraction performed	Assessment time point	Patient's global assessment of disease activity at baseline, mean (SD) <sup>a</sup>	Patient's global assessment of disease activity at follow-up, mean (SD) <sup>b</sup>	% change from baseline	Evaluator's global assessment of disease activity at baseline, mean (SD) <sup>a</sup>	Evaluator's global assessment of disease activity at follow-up <sup>a</sup>	% change from baseline
AMPLE <sup>66</sup>	ABT s.c.	12 months	61.1 (22.1)	NR	46.1 (as reported)	58.8 (18.6)	NR	68.5 (as reported)
	ADA	12 months	61.5 (22.5)	NR	41.2 (as reported)	58.8 (18.9)	NR	63.0 (as reported)
<sup>b</sup> RED-SEA <sup>14</sup>	ADA + cDMARDs	12 months	70 (50–82)	49 (20–65)	NR	NR	NR	NR
	ETN50 + cDMARDs	12 months	70 (54–80)	50 (27–71)	NR	NR	NR	NR
deFilippis <i>et al.</i> , 2006 <sup>85</sup>	ETN + MTX	22 weeks	64.33 (18.89)	NR	34.8 (as reported)	58.33 (14.60)	NR	38.3 (as reported)
	IFX + MTX	22 weeks	69.33 (16.57)	NR	21.4 (as reported)	60.67 (12.0)	NR	35.6 (as reported)
deFilippis <i>et al.</i> , 2006 <sup>85</sup>	ETN + MTX	54 weeks	64.33 (18.89)	74.88	50.6 (as reported)	58.33 (14.60)	77.05	41.8 (as reported)
	IFX + MTX	54 weeks	69.33 (16.57)	86.91	22.2 (as reported)	60.67 (12.0)	83.31	43.6 (as reported)

ETN50, etanercept 50 mg once a week subcutaneously; NR, not reported.  
a Reported on 0–100 VAS scale unless otherwise stated.  
b Median (interquartile range).  
ABT s.c. = ABT 125 mg once per week subcutaneously, following an optional i.v. loading dose of ≈10 mg/kg based on weight range.  
ADA = ADA 40 mg every other week subcutaneously.  
CTZ = s.c. CTZ 400 mg at weeks 1, 2 and 4, then 200 mg every other week.  
ETN = ETN 25 mg twice a week subcutaneously.  
IFX = IFX 3 mg/kg intravenously at weeks 0, 2, 6 and every 8 weeks thereafter (with dose escalation permitted after week 12 if lack of response).  
Data are shown to the level of accuracy available in the source material.

TABLE 358 Global assessments of disease activity: populations 2 and 3 RCTs of biologic vs. DMARD(s) or PBO

Trial name/ study	Treatment arms for which data extraction performed	Assessment time point	Patient's global assessment of disease activity at baseline, mean (SD) <sup>a</sup>	Patient's global assessment of disease activity at follow-up, mean (SD) <sup>a</sup>	% change from baseline, mean (SD)	Evaluator's global assessment of disease activity at baseline, mean (SD) <sup>a</sup>	Evaluator's global assessment of disease activity at follow-up <sup>a</sup>	% change from baseline, mean (SD)
AIM <sup>62</sup>	PBO + MTX	12 months	62.8 (21.6)	NR	Adjusted mean change -24.2 (1.72)	67.4 (17.0)	NR	Adjusted mean change -34.3 (1.44)
	ABT i.v. + MTX	12 months	62.7 (21.2)	NR	Adjusted mean change -35.8 (1.12)	68.0 (16.0)	NR	Adjusted mean change -49.1 (0.93)
ASSURE <sup>73</sup>	PBO + cDMARDs	1 year	61.3 (20.1)	NR	20	58.3 (17.5)	NR	37
	ABT + cDMARDs	1 year	60.6 (19.7)	NR	41	57.8 (17.4)	NR	56
CHANGE <sup>80</sup>	PBO	24 weeks	64.6 (22.9)	NR	Mean change 2.6 (23.5)	74.1 (15.6)	NR	Mean change -8.0 (21.8)
	ADA monotherapy	24 weeks	71.2 (19.2)	NR	Mean change -19.9 (31.0) <sup>b</sup>	76.2 (14.7)	NR	Mean change -30.3 (24.8) <sup>b</sup>
DE019 <sup>84</sup>	PBO + MTX	52 weeks	54.3 (22.9)	NR	-20.1	61.3 (17.3)	NR	-31.8
	ADA + MTX	52 weeks	52.7 (21.0)	NR	-52.2	62.0 (16.7)	NR	-63.5
Van De Putte <i>et al.</i> , 2004 <sup>122</sup>	PBO	26 weeks	71.8 (19.9)	NR	-7.9	68.5 (18.2)	NR	-12.9
	ADA monotherapy	26 weeks	72.6 (19.3)	NR	-38.9 <sup>c</sup>	67.3 (16.6)	NR	-38.8 <sup>c</sup>
ARMADA <sup>69,70</sup>	PBO + MTX	24 weeks	58.0 (23.2)	NR	-14.7	58.9 (15.3)	NR	-11.6
	ADA + MTX	24 weeks	56.9 (21.1)	NR	-52.4 <sup>c</sup>	58.7 (15.8)	NR	-53.0 <sup>c</sup>
Kim <i>et al.</i> , 2007 <sup>99</sup>	PBO + MTX	24 weeks	63.2 (20.44)	NR	Mean change -10.7 (24.85)	64.0 (13.61)	NR	Mean change -9.6 (26.47)
	ADA + MTX	24 weeks	59.7 (17.19)	NR	Mean change -23.7 (26.54) <sup>b</sup>	63.7 (15.16)	NR	Mean change -29.2 (27.48) <sup>c</sup>

continued

**TABLE 358** Global assessments of disease activity: populations 2 and 3 RCTs of biologic vs. DMARD(s) or PBO (continued)

Trial name/ study	Treatment arms for which data extraction performed	Assessment time point	Patient's global assessment of disease activity at baseline, mean (SD) <sup>a</sup>	Patient's global assessment of disease activity at follow-up, mean (SD) <sup>b</sup>	% change from baseline, mean (SD)	Evaluator's global assessment of disease activity at baseline, mean (SD) <sup>a</sup>	Evaluator's global assessment of disease activity at follow-up <sup>a</sup>	% change from baseline, mean (SD)
ADORE <sup>59</sup>	ETN monotherapy	16 weeks	(0–10 scale)	NR	(0–10 scale)	NR	NR	NR
			6.6		Mean change from baseline –2.78 (2.60)			
	ETN + MTX	16 weeks	(0–10 scale)	NR	(0–10 scale)	NR	NR	NR
			6.6		Mean change from baseline –2.95 (2.59)			
ETN study 309 <sup>89</sup>	PBO + SSZ	24 weeks	NR	NR	(0–10 scale)	NR	NR	(0–10 scale)
	ETN + PBO	24 weeks	NR	NR	13.6			16.0
	ETN + SSZ	24 weeks	NR	NR	50.5 <sup>c</sup> vs. SSZ	NR	NR	59.5 <sup>c</sup> vs. SSZ
					53.5 <sup>c</sup> vs. SSZ, NS vs. ETN + PBO	NR	NR	62.0 <sup>c</sup> vs. SSZ, NS vs. ETN + PBO
JESMR <sup>140</sup>	ETN monotherapy	24 weeks	62.5 (20.5)	31.5 (28.4)	NR	58.2 (21.5)	NR	NR
	ETN + MTX	24 weeks	53.7 (23.7)	21.6 (18.8)	NR	58.2 (19.3)	NR	NR
JESMR <sup>140</sup>	ETN monotherapy	52 weeks	62.5 (20.5)	27.4 (25.1)	NR	NR	NR	NR
	ETN + MTX	52 weeks	53.7 (23.7)	21.3 (19.4)	NR	NR	NR	NR
Lan <i>et al.</i> , 2004 <sup>101</sup>	PBO + MTX	12 weeks	69.7	61.4	NR	79.7	54.2	NR
	ETN + MTX	12 weeks	66.2	37.9	NR	75.2	22.8	NR

Trial name/ study	Treatment arms for which data extraction performed	Assessment time point	Patient's global assessment of disease activity at baseline, mean (SD) <sup>a</sup>	Patient's global assessment of disease activity at follow-up, mean (SD) <sup>b</sup>	% change from baseline, mean (SD)	Evaluator's global assessment of disease activity at baseline, mean (SD) <sup>a</sup>	Evaluator's global assessment of disease activity at follow-up <sup>a</sup>	% change from baseline, mean (SD)
LARA <sup>102</sup>	MTX + DMARD	24 weeks	(1–10 scale) 7.1 (1.9)	NR	(1–10 scale) Adjusted mean change –2.3 (SE 0.2)	(1–10 scale) 6.7 (1.6)	NR	(1–10 scale) Adjusted mean change –2.4 (SE 0.2)
	ETN50 + MTX	24 weeks	(1–10 scale) 7.1 (2.0)	NR	(1–10 scale) Adjusted mean change –3.9 (SE 0.2) <sup>f</sup>	(scale 1–10) 6.7 (1.6)	NR	(1–10 scale) Adjusted mean change –4.8 (SE 0.1) <sup>c</sup>
Moreland <i>et al.</i> , 1999, <sup>104</sup> Mathias <i>et al.</i> , 2000 <sup>105</sup>	PBO	6 months	(0–10 scale) 6.9	NR	3 (worse)	(0–10 scale) 6.9	NR	2 (improved)
	ETN + PBO	6 months	(0–10 scale) 7.0	NR	6 (improved) between groups <sup>d</sup>	(0–10 scale) 6.9	NR	44 (improved) between groups <sup>e</sup>
RACAT <sup>111</sup>	MTX + SSZ + HCQ ( <i>n</i> = 178; not all analysed)	24 weeks	(scale 0–10) 5.43 (2.20)	3.51 (2.19)	NR	(scale 0–100) 60.14 (22.98)	35.70 (22.18)	NR
	ETN50 + MTX ( <i>n</i> = 175; not all analysed)		5.63 (1.95)	3.18 (2.32)	NR	61.06 (20.01)	35.35 (24.43)	NR
	MTX + SSZ + HCQ ( <i>n</i> = 178; not all analysed, some switched)	48 weeks ( <i>n</i> = 310 both groups)	(scale 0–10) 5.43 (2.20)	3.01 (2.33)	NR	(scale 0–100) 60.14 (22.98)	32.87 (25.07)	NR
	ETN50 + MTX ( <i>n</i> = 175; not all analysed, some switched)		5.63 (1.95)	2.98 (2.38)	NR	61.06 (20.01)	30.77 (23.05)	NR
APPEAL <sup>67,68</sup>	MTX + DMARD (SSZ, HCQ or LEF)	16 weeks	6.5 (1.8)	4.5	30.6	6.6 (1.8)	3.6	45.0
	ETN + MTX	16 weeks	6.7 (2.0)	3.3	50.8	6.6 (1.7)	2.5	62.1

continued

TABLE 358 Global assessments of disease activity: populations 2 and 3 RCTs of biologic vs. DMARD(s) or PBO (continued)

Trial name/ study	Treatment arms for which data extraction performed	Assessment time point	Patient's global assessment of disease activity at baseline, mean (SD) <sup>a</sup>	Patient's global assessment of disease activity at follow-up, mean (SD) <sup>a</sup>	% change from baseline, mean (SD)	Evaluator's global assessment of disease activity at baseline, mean (SD) <sup>a</sup>	Evaluator's global assessment of disease activity at follow-up <sup>a</sup>	% change from baseline, mean (SD)
Weinblatt <i>et al.</i> , 1999 <sup>124</sup>	PBO + MTX	24 weeks	(0–10 scale) 6.0 <sup>d</sup>	(0–10 scale) 4.0 <sup>d</sup>	NR	(0–10 scale) 6.5 <sup>d</sup>	(0–10 scale) 4.0 <sup>d</sup>	NR
	ETN + MTX	24 weeks	(0–10 scale) 6.0 <sup>d</sup>	(0–10 scale) 2.0 <sup>b,d</sup>	NR	(0–10 scale) 6.0 <sup>d</sup>	(0–10 scale) 2.0 <sup>b,d</sup>	NR
GO-FORWARD <sup>92</sup>	PBO + MTX	Week 14	(0–10 scale) 5.30 (3.70–7.20) <sup>d</sup>	NR	–14.6 (+10.8, –50.0) <sup>d</sup>	(0–10 scale) 5.65 (4.30–6.85) <sup>d</sup>	NR	–34.9 (+2.4 to –64.6) <sup>d</sup>
	GOL + MTX	Week 14	(0–10 scale) 6.00 (3.80–7.90) <sup>d</sup>	NR	–45.3 (–16.7 to –76.9) <sup>c,d</sup>	(0–10 scale) 6.10 (5.10–7.10) <sup>d</sup>	NR	–54.5 (–35.2 to –72.9) <sup>c,d</sup>
GO-FORWARD <sup>92</sup>	PBO + MTX	Week 24	(0–10 scale) 5.30 (3.70–7.20) <sup>d</sup>	NR	–17.3 (+16.3 to –46.0) <sup>d</sup>	(0–10 scale) 5.65 (4.30–6.85) <sup>d</sup>	NR	–39.1 (–1.3 to –67.3) <sup>d</sup>
	GOL + MTX	Week 24	(0–10 scale) 6.0 (3.8–7.9) <sup>d</sup>	NR	–47.9 (–17.0 to –76.1) <sup>c,d</sup>	(0–10 scale) 6.1 (5.1–7.1) <sup>d</sup>	NR	–61.7 (–38.7 to –82.1) <sup>c,d</sup>
ATTRACT <sup>75</sup>	PBO + MTX	30 weeks	(0–10 scale) 6.2 (4.3–8.1) <sup>d</sup>	(0–10 scale) 5.5 (3.1–7.5) <sup>d</sup>	–7	(0–10 scale) 6.5 (5.2–7.4) <sup>d</sup>	(0–10 scale) 5.0 (3.0–7.0) <sup>d</sup>	–13
	IFX + MTX	30 weeks	(0–10 scale) 6.6 (4.9–7.8) <sup>d</sup>	(0–10 scale) 3.6 (1.8–6.7) <sup>d</sup>	–23 <sup>b</sup>	(0–10 scale) 6.1 (4.8–7.1) <sup>d</sup>	(0–10 scale) 2.6 (1.5–5.2) <sup>d</sup>	–53 <sup>c</sup>
Durez <i>et al.</i> , 2004 <sup>86</sup>	MP + MTX	14 weeks	63 (19–100) <sup>d</sup>	50 <sup>e</sup>	NR	58 (18–83) <sup>d</sup>	59 <sup>e</sup>	NR
	IFX + MTX	14 weeks	52 (15–80) <sup>d</sup>	42 <sup>e</sup>	NR	43 (14–85) <sup>d</sup>	16 <sup>c,e</sup>	NR
Wong <i>et al.</i> , 2009 <sup>125</sup>	PBO + MTX	Week 16	70 (25)	68 <sup>e</sup>	NR	NR	NR	NR
	IFX + MTX	Week 16	68 (15)	32 <sup>b,e</sup>	NR	NR	NR	NR

Trial name/ study	Treatment arms for which data extraction performed	Assessment time point	Patient's global assessment of disease activity at baseline, mean (SD) <sup>a</sup>	Patient's global assessment of disease activity at follow-up, mean (SD) <sup>b</sup>	% change from baseline, mean (SD)	Evaluator's global assessment of disease activity at baseline, mean (SD) <sup>b</sup>	Evaluator's global assessment of disease activity at follow-up <sup>a</sup>	% change from baseline, mean (SD)
ACT-RAY <sup>57</sup>	TCZ + oral PBO	Week 24	NR	NR	Mean change -32.4 (SD 24.34)	NR	NR	Mean change -38.5 (SD 21.65)
	TCZ + MTX	Week 24	NR	NR	Mean change -34.3 (SD 25.68)	NR	NR	Mean change -40.7 (SD 19.55)
SATORI <sup>322</sup>	PBO + MTX	24 weeks	57 <sup>e</sup>	47 <sup>e</sup>	NR	60 <sup>e</sup>	47 <sup>e</sup>	NR
	TCZ + PBO capsules	24 weeks	60 <sup>e</sup>	28 <sup>e</sup>	NR	63 <sup>e</sup>	22 <sup>e</sup>	NR
TACIT <sup>141</sup>	Combination cDMARDs	AIC information has been removed	AIC information has been removed	AIC information has been removed	AIC information has been removed	AIC information has been removed	AIC information has been removed	AIC information has been removed
	TNF inhibitor + DMARD	AIC information has been removed	AIC information has been removed	AIC information has been removed	AIC information has been removed	AIC information has been removed	AIC information has been removed	AIC information has been removed

AIM, Abatacept in Inadequate responders to Methotrexate; ASSURE, Abatacept Study of Safety in Use with other RA Therapies; CHANGE, Clinical investigation in Highly disease-affected rheumatoid Arthritis patients in Japan with Adalimumab applying standard and General Evaluation study; ETN50, etanercept 50 mg once a week subcutaneously; NR, not reported; NS, non-significant; SATORI, Study of Active controlled Tocilizumab for Rheumatoid arthritis patients with an inadequate response to methotrexate.

ABT i.v. = BT ≈10 mg/kg intravenously on weeks 0, 2 and 4, and every 4 weeks thereafter.

ADA = ADA 40 mg every other week subcutaneously.

CTZ = s.c. CTZ 400 mg at weeks 1, 2 and 4, then 200 mg every other week.

ETN = ETN 25 mg twice a week subcutaneously.

GOL = GOL 50 mg every 4 weeks subcutaneously.

IFX = IFX 3 mg/kg intravenously at weeks 0, 2, 6 and every 8 weeks thereafter (with dose escalation permitted after week 12 if lack of response).

TCZ = TCZ 8 mg/kg intravenously every 4 weeks.

a Reported on 0–100 VAS scale unless otherwise stated.

b  $p < 0.05$ .

c  $p < 0.001$ .

d Median (interquartile range).

e Estimated from graphical data.

Data are shown to the level of accuracy available in the source material.

TABLE 359 Radiographic score data: population 1 RCTs of biologic interventions vs. DMARD(s) or PBO

Trial name	Scoring system applied	Treatment arms for which data extraction performed	Assessment point	Mean (SD) change from baseline in total score	Mean (SD) change from baseline in erosion score	Mean (SD) change from baseline in JSN score	Radiographic non-progression
GUEPARD <sup>93</sup>	van der Heijde-modified Sharp score data <sup>323</sup>	Initial MTX 12 weeks, then step-up therapy in both groups based on DAS28 (n = 29)	52 weeks	(Score range of 0–448) 1.8 (4.7)	NR	NR	% patients with no radiographic progression = 55 (16/29)
		Initial ADA + MTX 12 weeks, then step-up therapy in both groups based on DAS28 (n = 27)	52 weeks	1.9 (4)	NR	NR	% patients with no radiographic progression = 59 (16/27)
OPTIMA <sup>108</sup>	van der Heijde-modified total Sharp score	PBO + MTX (n = 517; n = 514 analysed for $\Delta$ modified total Sharp score)	26 weeks	0.96 (NR)	0.48 (NR)	0.48 (SD NR)	( $\Delta$ modified total Sharp score $\leq 0.5$ ), 72%
		ADA + MTX (n = 515; n = 508 analysed for $\Delta$ modified total Sharp score)	26 weeks	0.15 <sup>a</sup> (NR)	0.10 <sup>a</sup> (NR)	0.05 <sup>b</sup> (SD NR)	87% <sup>a</sup>
PREMIER <sup>109</sup>	van der Heijde-modified total Sharp score	PBO + MTX (n = 257)	1 year	(0–398, with higher scores indicating greater progression) 5.7 worse	(Scale NR, higher scores indicate worse erosion) 3.7 worse	(Scale NR, higher scores indicate worse JSN) 2.0 worse	(Change in modified total Sharp score $\leq 0.5$ from baseline), 37%
		ADA monotherapy + PBO (n = 274)	1 year	3.0 worse	1.7 worse	1.3 worse	51% <sup>b</sup> (vs. MTX monotherapy)
		ADA + MTX (n = 268)	1 year	1.3 worse <sup>a</sup> (vs. MTX monotherapy vs. ADA monotherapy)	0.8 worse <sup>a</sup> (vs. MTX monotherapy vs. ADA monotherapy)	0.5 worse	64% <sup>b</sup> (vs. MTX monotherapy vs. ADA monotherapy)



Trial name	Scoring system applied	Treatment arms for which data extraction performed	Assessment point	Mean (SD) change from baseline in total score	Mean (SD) change from baseline in erosion score	Mean (SD) change from baseline in JSN score	Radiographic non-progression
PREMIER <sup>109</sup>	van der Heijde-modified total Sharp score	PBO + MTX (n = 257)	2 years	10.4 worse	6.4 worse	4.0 worse	34%
		ADA monotherapy + PBO (n = 274)	2 years	5.5 worse	3.0 worse	2.6 worse	45% <sup>b</sup> (vs. MTX monotherapy)
		ADA + MTX (n = 268)	2 years	1.9 worse <sup>a</sup> (vs. MTX monotherapy vs. ADA monotherapy)	1.0 worse <sup>a</sup> (vs. MTX monotherapy vs. ADA monotherapy)	0.9 worse	61% <sup>b</sup> (vs. MTX monotherapy vs. ADA monotherapy)
COMET <sup>81,83</sup>	van der Heijde-modified total Sharp score	PBO + MTX (n = 230)	52 weeks	2.44 (95% CI 1.45 to 3.43)	NR	NR	(Defined as modified total Sharp score of ≤ 0.5)
		ETN + MTX (n = 246)	52 weeks	0.27 (95% CI -0.13 to 0.68)	NR	NR	135/230 (59%) 196/246 (80%)
ERA <sup>139</sup>	Total modified Sharp score	PBO + MTX (n = 217)	6 months	[modified total Sharp score 0 (no damage) to 398 (severe joint destruction) scale]	[Erosion score 0 (no new erosion) to 230 (new erosion, worsening of erosion)]	[JSN score 0 (no narrowing) to 168 (complete loss of joint space)]	NR
		ETN + PBO (n = 207)	6 months	0.57 <sup>a</sup> (worse)	0.65 (worse) <sup>c</sup>	0.35 (worse) <sup>c</sup>	NR
		PBO + MTX (n = 217)	12 months	1.59 (worse)	1.0 (worse) <sup>c</sup>	0.55 (worse) <sup>c</sup>	NR
ERA <sup>139</sup>	Total modified Sharp score	ETN + PBO (n = 207)	12 months	1.00 (worse)	0.45 <sup>b,c</sup> (worse)	0.55 (worse)	NR

continued

TABLE 359 Radiographic score data: population 1 RCTs of biologic interventions vs. DMARD(s) or PBO (continued)

Trial name	Scoring system applied	Treatment arms for which data extraction performed	Assessment point	Mean (SD) change from baseline in total score	Mean (SD) change from baseline in erosion score	Mean (SD) change from baseline in JSN score	Radiographic non-progression
ASPIRE <sup>71</sup>	van der Heijde-modified Sharp score data	PBO + MTX (n = 282 for total score, n = 226 for erosion and JSN scores)	54 weeks	(Scale 0–48, higher score = more joint damage) 3.7 (9.6)	(Scale 0–280) 3.0 (7.8)	(Scale 0–168) 0.6 (2.1)	NR
		IFX + MTX	54 weeks	0.43 <sup>d</sup> (0.0, 4.5) 0.4 (5.8)	0.3 <sup>d</sup> (0.0, 3.8) 0.3 (4.9)	0.0 <sup>d</sup> (0.0, 0.4) 0.1 (1.6)	NR
		(n = 359 for total score, n = 306 for erosion and JSN scores)		0.0 <sup>d</sup> (–0.8, 1.3) <sup>a</sup>	0.0 <sup>d</sup> (–0.8, 1.3) <sup>a</sup>	0.0 <sup>d</sup> (0.0, 0.0) <sup>a</sup>	

ASPIRE, Active controlled Study of Patients receiving Infliximab for the treatment of Rheumatoid arthritis of Early onset; ERA, Early Rheumatoid Arthritis (etanercept); JSN, joint space narrowing; NR, not reported; OPTIMA, OPTimal protocol for treatment Initiation with Methotrexate and Adalimumab.

ABT s.c. = ABT 125 mg once per week subcutaneously, following an optional i.v. loading dose of ≈10 mg/kg based on weight range.

ADA = ADA 40 mg every other week subcutaneously.

ETN = ETN 25 mg twice a week subcutaneously.

IFX = IFX 3 mg/kg intravenously at weeks 0, 2, 6 and every 8 weeks thereafter (with dose escalation permitted after week 12 if lack of response).

a  $p < 0.001$ .

b  $p < 0.05$ .

c Estimated from graphical data.

d Median.

Data are shown to the level of accuracy available in the source material.

**TABLE 360** Assessments of synovitis, erosion and osteitis: population 1 RCTs of biologic interventions vs. DMARD(s) or PBO

Trial name/ study	Treatment arms for which data extraction performed	Assessment point	Mean change from baseline in synovitis (SD)	Mean change from baseline in erosions (SD)	Mean change from baseline in osteitis (SD)
OPTIMA <sup>108</sup> / Peterfy <i>et al.</i> , 2010 <sup>150</sup>	PBO + MTX ( <i>n</i> = 32)	26 weeks	OMERACT-RAMRIS scoring system. Progression or improvement of magnetic resonance imaging scores defined as positive or negative change from baseline $\geq$ smallest detectable change respectively -2.0 (improved) % patients showing progression = 6 % patients showing improvement = 44	OMERACT-RAMRIS scoring system 1.4 (worse) % patients showing progression = 38 % patients showing improvement = 9	OMERACT-RAMRIS scoring system 0.0 % patients showing progression = 13 % patients showing improvement = 9
	ADA + MTX ( <i>n</i> = 27)	26 weeks	-3.6 (improved) % patients showing progression = 0 % patients showing improvement = 74 <sup>a</sup> [RAMRIS scores (higher RAMRIS scores = more severe inflammation/ damage)] Wrist + MCP joints (range 0–21) Mean = -1.04 (3.04) Median = -1.00 (IQR -1.63 to 0.00) Wrist joints only (range 0–9) Mean = -0.74 (1.86) Median = -0.50 (IQR -1.00 to 1.00)	-0.8 (improved) % patients showing progression = 4 <sup>a</sup> % patients showing improvement = 22 (RAMRIS scores; (range 0–230) -0.24 (6.39) 0.00 <sup>b</sup> (IQR 0.00 to 0.50)	-4.0 (improved) % patients showing progression = 0 % patients showing improvement = 30 [RAMRIS scores oedema (osteitis) (range 0–69)] -0.32 (4.66) 0.00 <sup>b</sup> (IQR -1.50 to 1.00)
GO-BEFORE <sup>151</sup>	PBO + MTX (synovitis <i>n</i> = 81 wrists + MCP joint, <i>n</i> = 82 wrist joints only, osteitis and erosion <i>n</i> = 82)	24 weeks			

continued

TABLE 360 Assessments of synovitis, erosion and osteitis: population 1 RCTs of biologic interventions vs. DMARD(s) or PBO (continued)

Trial name/ study	Treatment arms for which data extraction performed	Assessment point	Mean change from baseline in synovitis (SD)	Mean change from baseline in erosions (SD)	Mean change from baseline in osteitis (SD)
	GOL + MTX (synovitis $n = 77$ wrists + MCP joint, $n = 78$ wrist joints only, osteitis and erosion $n = 78$ )	24 weeks	Wrist + MCP joints (range 0–21) –2.21 (3.10) –1.50 (IQR –3.50 to –0.33) <sup>a,b</sup>	(Range 0–230) –0.65 (5.98) 0.00 (–0.58, 0.00) <sup>a,b</sup>	Oedema (osteitis) (range 0–69) –2.47 (4.08) –1.00 (–3.00, 0.00) <sup>a,b</sup>
			Wrist joints only (range 0–9) –1.29 (1.67) –1.00 (IQR –2.50 to 0.00) <sup>a,b</sup>		

IQR, interquartile range; MCP, metacarpophalangeal; OPTIMA, OPTimal protocol for treatment Initiation with Methotrexate and Adalimumab; RAMRIS, Rheumatoid Arthritis Magnetic Resonance Imaging Score.  
 ADA = ADA 40 mg every other week subcutaneously.  
 GOL = GOL 50 mg every 4 weeks subcutaneously.  
 a  $p < 0.05$ .  
 b Median.

TABLE 361 Radiographic score data: populations 2 and 3 head-to-head biologic RCTs

Trial name	Scoring system applied	Treatment arms for which data extraction performed	Assessment point	Mean (SD) change from baseline in total score	Mean (SD) change from baseline in erosion score	Mean (SD) change from baseline in JSN score	Radiographic non-progression
AMPLE <sup>66</sup>	Modified Sharp/van der Heijde scoring system	ABT s.c. (n = 318, 91.1% assessed for radiographic non-progression)	1 year	(Scale 0-448, direction NR) 0.58 (3.22)	(Scale and direction NR) 0.29 (1.84)	(Scale and direction NR) 0.28 (1.92)	(Change from baseline in total score $\leq$ smallest detectable change at cut-off 2.8) 84.8%
		ADA (n = 328, 88.1% assessed for radiographic non-progression)	1 year	0.38 (5)	-0.01 (2.83)	0.39 (2.50)	88.6%

JSN, joint space narrowing; NR, not reported.  
 ABT s.c. = ABT 125 mg once per week subcutaneously, following an optional i.v. loading dose of  $\approx$ 10 mg/kg based on weight range.  
 ADA = ADA 40 mg every other week subcutaneously.

TABLE 362 Radiographic score data: populations 2 and 3 RCTs of biologic interventions vs. DMARD(s) or PBO

Trial name	Scoring system applied	Treatment arms for which data extraction performed	Assessment point	Mean (SD) change from baseline in total score	Mean (SD) change from baseline in erosion score	Mean (SD) change from baseline in JSN score	Radiographic non-progression
AIM <sup>61,62</sup>	Total Genant-modified Sharp score	PBO + MTX (n = 195)	1 year	2.32 (NR)	1.14 (NR)	1.18 (NR)	NR
				0.53 (0.0, 2.5) <sup>a</sup>	0.27 (0.0, 1.3) <sup>ab</sup>	0.0 (0.0, 1.0) <sup>ab</sup>	
				1.21 (NR)	0.63 (NR)	0.58 (NR)	NR
DE019 <sup>84</sup>	Total Sharp score	PBO + MTX (n = 200)	52 weeks	0.25 (0.0, 1.8) <sup>ab</sup>	0.0 (0.0, 1.0) <sup>ab</sup>	0.0 (0.0, 0.5) <sup>ab</sup>	NR
				2.7 (6.8)	1.6 (4.4)	1.0 (3.0)	
						% patients with improvement or no change in JSN = 52.2	
JESMR <sup>140</sup>	van der Heijde-modified Sharp score	ETA + MTX (n = 207)	52 weeks	0.1 (4.8) <sup>c</sup>	0.0 (2.8) <sup>c</sup>	0.1 (2.3) <sup>b</sup> % patients with improvement or no change in JSN = 68.5 <sup>b</sup>	NR
				(0-448, positive score indicates progression)	(Scale NR, positive value indicates progression)	(Scale NR, positive value indicates progression)	NR
				2.57 (NR)	1.16 (NR)	1.42 (NR)	
		ETA + MTX (n = 76)	24 weeks	0.34 (NR)	-0.02 (NR)	0.37 (NR)	NR

Trial name	Scoring system applied	Treatment arms for which data extraction performed	Assessment point	Mean (SD) change from baseline in total score	Mean (SD) change from baseline in erosion score	Mean (SD) change from baseline in JSN score	Radiographic non-progression
JESMR <sup>140</sup>	van der Heijde-modified Sharp score	ETN monotherapy (n = 71)	52 weeks	3.6 (NR)	1.87 (NR)	1.78 (NR)	No radiographic progression to week 52 (change $\leq 0.5$ ) = 39.6%
		ETN + MTX (n = 76)	52 weeks	0.8 (NR)	-0.15 (NR) <sup>b</sup>	1.01 (NR)	No clinically significant radiographic progression to week 52 ( $\leq$ smallest detectable change) = 58.5%
LARA <sup>102</sup>	Modified total Sharp score	MTX + DMARD (n = 119)	24 weeks	Adjusted mean change = 1.4 (SE 0.5)	Adjusted mean change = 1.1 (SE 0.3)	Adjusted mean change = 0.2 (SE 0.3)	No radiographic progression to week 52 (change $\leq 0.5$ ) = 57.4%
		ETN + MTX (n = 247)	24 weeks	Adjusted mean change = 0.4 (SE 0.4) <sup>b</sup>	Adjusted mean change = 0.4 (SE 0.2) <sup>b</sup>	Adjusted mean change = -0.1 (SE 0.2)	No clinically significant radiographic progression to week 52 ( $\leq$ smallest detectable change) = 67.6%
RACAT <sup>111</sup>	van der Heijde-modified Sharp score	MTX + SSZ + HCQ (n = 158)	24 weeks	0.42 (1.91)	0.23 (1.32)	0.19 (1.25)	NR
		ETN50 + MTX (n = 160)	24 weeks	0.003 (0.62)	-0.03 (0.44)	0.03 (2.47)	NR
RACAT <sup>111</sup>	van der Heijde-modified Sharp score	MTX + SSZ + HCQ (n = 151)	48 weeks	0.54 (1.93)	0.29 (1.35)	0.25 (1.18)	NR
		ETN50 + MTX (n = 153)	48 weeks	0.29 (3.32)	0.08 (1.48)	0.21 (2.09)	NR

continued

TABLE 362 Radiographic score data: populations 2 and 3 RCTs of biologic interventions vs. DMARD(s) or PBO (continued)

Trial name	Scoring system applied	Treatment arms for which data extraction performed	Assessment point	Mean (SD) change from baseline in total score	Mean (SD) change from baseline in erosion score	Mean (SD) change from baseline in JSN score	Radiographic non-progression
GO-FORTH <sup>91</sup>	van der Heijde-modified Sharp score	PBO + MTX (n = 88)	24 weeks	Scale NR, positive value indicates greater progression 2.51 (5.52)	Scale NR, positive value indicates greater progression 1.66 (3.73) (n = 84)	Scale NR, positive value indicates greater progression 0.83 (2.31) (n = 84)	(No increase in total van der Heijde Sharp score, i.e. change from baseline to week 24 < 0) 44/88 (50.0%)
		GOL + MTX (n = 66)	24 weeks	1.05 (3.71) <sup>b</sup>	0.54 (1.62) <sup>b</sup> (n = 81)	0.71 (2.91) (n = 81)	51/86 (59.3%)
ATTRACT <sup>146</sup>	van der Heijde-modified Sharp score	PBO + MTX (n = 64)	54 weeks	(Total scores range 0–440, higher scores indicating more joint damage) 7.0 (10.3)	(Erosion scores range 0–280) 4.0 (7.9)	(JSN scores range 0–160) 2.9 (4.2)	Major progression (% patients) = 31 Improvement (% patients) = 14
		IFX + MTX (n = 71)	54 weeks	1.3 (6.0) <sup>c</sup>	0.2 (2.9) <sup>c</sup>	1.1 (4.4) <sup>c</sup>	Major progression (% patients) = 8 <sup>c</sup> Improvement (% patients) = 44 <sup>c</sup>
Swefot <sup>147</sup>	van der Heijde-modified Sharp score	SSZ + HCQ + MTX (n = 109)	24 months from baseline (i.e. 20–21 months post-randomisation)	Treatment difference = 3.23 (95% CI 0.14 to 6.32) <sup>b</sup>	Treatment difference = 1.53 (95% CI –0.03 to 3.09) <sup>b</sup>	Treatment difference = 1.66 (95% CI –0.14 to 3.46) <sup>b</sup>	NR
		IFX + MTX (n = 106)	24 months from baseline (i.e. 20–21 months post-randomisation)				NR



Trial name	Scoring system applied	Treatment arms for which data extraction performed	Assessment point	Mean (SD) change from baseline in total score	Mean (SD) change from baseline in erosion score	Mean (SD) change from baseline in JSN score	Radiographic non-progression
ACT-RAY <sup>57</sup>	Total Genant-modified Sharp score	TCZ + oral PBO (n = 276)	24 weeks	0.22 (1.11)	0.11 (0.63)	0.11 (0.70)	% patients with no radiographic progression (change in score ≤ 0) = 58.7
		TCZ + MTX (n = 277)	24 weeks	0.08 (1.88)	-0.01 (0.78)	0.08 (1.48)	% patients with no radiographic progression (change in score ≤ 0) = 65.3
ACT-RAY <sup>52</sup>	Total Genant-modified Sharp score	TCZ + oral PBO (n = 276)	52 weeks	0.63 (NR)	NR	NR	% patients with no radiographic progression (change in score ≤ 0) = 57.6
		TCZ + MTX (n = 276)	52 weeks	0.40 (NR)	NR	NR	% patients with no radiographic progression (change in score ≤ 0) = 67.5
SAMURAI <sup>115</sup>	Modified total Sharp score (no further detail)	cDMARDs (n = 143)	52 weeks	Mean 6.1 (95% CI 4.2 to 8.0)	Mean 3.2 (95% CI 2.1 to 4.3)	Mean 2.9 (95% CI 2.0 to 3.8)	[Change from baseline in total Sharp score (0.5)]
		TCZ (n = 157)	52 weeks	2.3 (95% CI 1.5 to 3.2) <sup>b</sup>	Mean 0.9 (95% CI 0.3 to 1.4) <sup>c</sup>	Mean 1.5 (95% CI 0.9 to 2.1) <sup>c</sup>	39% 56% <sup>b</sup>

AIM, Abatacept in Inadequate responders to Methotrexate; ETN50, etanercept 50 mg once a week subcutaneously; JSN, joint space narrowing; NR, not reported.  
 ABT i.v. = BT ≈ 10 mg/kg intravenously on weeks 0, 2 and 4, and every 4 weeks thereafter.  
 ADA = ADA 40 mg every other week subcutaneously.  
 ETN = ETN 25 mg twice a week subcutaneously.  
 GOL = GOL 50 mg every 4 weeks subcutaneously.  
 IFX = IFX 3 mg/kg intravenously at weeks 0, 2, 6 and every 8 weeks thereafter (with dose escalation permitted after week 12 if lack of response).  
 TCZ = TCZ 8 mg/kg intravenously every 4 weeks.  
 a Median (25th, 75th percentiles).  
 b *p* < 0.05.  
 c *p* < 0.001.  
 Data are shown to the level of accuracy available in the source material.

TABLE 363 Assessments of synovitis, erosion and osteitis: populations 2 and 3 RCTs of biologic interventions vs. DMARD(s) or PBO

Trial name/ study	Treatment arms for which data extraction performed	Assessment point	Mean change from baseline in synovitis	Mean change from baseline in erosions	Mean change from baseline in osteitis
ASSET <sup>72</sup>	PBO + MTX (n = 23)	4 months	(OMERACT-RAMRIS scores) Adjusted mean change (wrists) = 0.38 (SE 0.27)	(OMERACT-RAMRIS scores) Adjusted mean change (wrist and hand) = 0.95 (SE 0.45)	(OMERACT-RAMRIS scores) Adjusted mean change (wrist and hand) = 1.54 (SE 0.90)
	ABT i.v. + MTX (n = 25)	4 months	Adjusted mean change (wrists) = -0.31 (SE 0.26)	Adjusted mean change (wrist and hand) = 0.45 (SE 0.43)	Adjusted mean change (wrist and hand) = -1.94 (SE 0.86)
GO-FORWARD <sup>53</sup>	PBO + MTX (n = 72)	24 weeks	RAMRIS synovitis (wrist + MCP) -0.38 (2.66)	RAMRIS bone erosion score -0.47 (3.40)	RAMRIS bone oedema (osteitis) score 0.71 (7.54)
			-0.50 (IQR -1.45 to 1.00) <sup>a</sup>	0.00 (IQR -0.50 to 0.00) <sup>a</sup>	0.00 (IQR -0.50 to 0.50) <sup>a</sup>
			RAMRIS synovitis (wrist) 0.08 (1.51)		
			0.00 (IQR -1.00 to 1.00) <sup>a</sup>		
	GOL + MTX (n = 47)	24 weeks	RAMRIS synovitis (wrist + MCP) -1.85 (2.28)	RAMRIS bone erosion score -1.08 (4.35)	RAMRIS bone oedema (osteitis) score Mean = -2.58 (SD 4.75)
			-1.75 (-3.00, -0.50) <sup>a,b</sup>	0.00 (-0.50, 0.00) <sup>a</sup>	-0.50 (IQR -4.09 to 0.00) <sup>a,b</sup>
			RAMRIS synovitis (wrist) -1.13 (1.61)		
			1.00 (IQR -2.00 to 0.00) <sup>a,b</sup>		

Trial name/ study	Treatment arms for which data extraction performed	Assessment point	Mean change from baseline in synovitis	Mean change from baseline in erosions	Mean change from baseline in osteitis
Durez <i>et al.</i> , 2007 <sup>20</sup>	MTX (n = 14)	52 weeks	[OMERACT-RAMRIS scores. Global synovitis score ranged from 0 (absence of synovitis) to 66 (severe synovitis)] (Mean change NR) Score at baseline = 21 (15, 33) <sup>c,d</sup> Score at follow-up = 20 (12, 24) <sup>c,d</sup>	[OMERACT-RAMRIS scores. 0 (no erosion) to 300 (100% bone eroded)] (Mean change NR) Score at baseline = 12 (8, 25) <sup>c,d</sup> Score at follow-up = 14 (9, 32) <sup>c,d</sup>	(OMERACT-RAMRIS scores) (Mean change NR) Score at baseline = 13 (10, 31) <sup>d</sup> Score at follow-up = 13 (5, 21) <sup>d</sup>
	MTX + i.v. MP (n = 15 randomised)	52 weeks	Score at baseline = 29 (17, 33) <sup>c,d</sup> Score at follow-up = 14 (7, 29) <sup>c,d</sup>	Score at baseline = 5 (3, 23) <sup>c,d</sup> Score at follow-up = 13 (5, 41) <sup>c,d</sup>	Score at baseline = 22 (7, 40) <sup>c,d</sup> Score at follow-up = 12 (6, 38) <sup>c,d</sup>
	IFX + MTX (n = 15 randomised)	52 weeks	Score at baseline = 25 (15, 29) <sup>c,d</sup> Score at follow-up = 10 (6, 12) <sup>c,d</sup>	Score at baseline = 9 (5, 11) <sup>c,d</sup> Score at follow-up = 11 (6, 21) <sup>c,d</sup>	Score at baseline = 25 (12, 32) <sup>c,d</sup> Score at follow-up = 11 (7, 16) <sup>c,d</sup>

ASSET, Abatacept Systemic SclErosis Trial; MCP, metacarpophalangeal; NR, not reported; RAMRIS, Rheumatoid Arthritis Magnetic Resonance Imaging Score.  
 ADA = ADA 40 mg every other week subcutaneously.  
 GOL = GOL 50 mg every 4 weeks subcutaneously.  
 IFX = IFX 3 mg/kg intravenously at weeks 0, 2, 6 and every 8 weeks thereafter (with dose escalation permitted after week 12 if lack of response).  
 a Median.  
 b  $p < 0.001$ .  
 c Estimated from graphical data.  
 d Median (25th, 75th percentile).

TABLE 364 Pain VAS: population 1 biologic vs. DMARD(s) or PBO

Trial name/ study	Treatment arms for which data extraction performed	Assessment time point	n analysed	Mean pain VAS score at baseline, 0–100 (SD)	Mean pain VAS score at follow-up, 0–100 (SD)	Pain VAS mean change from baseline (SD)	Mean % change from baseline
OPERA <sup>107</sup>	MTX + PBO + steroid	12 months (primary end point and study RCT end point)	91	58 (13–92) <sup>a,b</sup>	20 (0–71) <sup>a</sup>	NR	NR
OPERA <sup>107</sup>	ADA + MTX + steroid	12 months (primary end point and study RCT end point)	89	63 (13–98) <sup>a,b</sup>	7 (0–64) <sup>a,c</sup>	NR	NR
OPTIMA <sup>154</sup>	MTX + PBO	26 weeks (study RCT end point)	517	65 (21)	49.4 (NR)	–37.9 (28.61) (n=513)	NR
OPTIMA <sup>108</sup>	ADA + MTX	26 weeks (study RCT end point)	515	65 (21)	36.1 (NR)	–28.9 (26.61) (n=513)	NR
PREMIER <sup>109</sup>	MTX + PBO	1 year (primary end point)	256	59.6 (24.3)	23.4 (16.1)	–36.2 (NR)	NR
PREMIER <sup>109</sup>	ADA monotherapy + PBO step-up week 16	1 year (primary end point)	273	64.6 (23.6)	26.6 (17.1)	–38.0 (NR)	NR
PREMIER <sup>109</sup>	ADA + MTX step-up week 16	1 year (primary end point)	265	62.5 (21.3)	16.8 (15.7) <sup>b,d</sup> (vs. MTX)	–45.7 (NR)	NR
PREMIER <sup>109</sup>	MTX + PBO	2 years (study RCT end point)	256	59.6 (24.3)	12.5 (15.8)	–47.1 (NR)	NR
PREMIER <sup>109</sup>	ADA monotherapy + PBO step up-week 16	2 years (study RCT end point)	273	64.6 (23.6)	19.6 (16.6)	–45.0 (NR)	NR
PREMIER <sup>109</sup>	ADA + MTX step-up week 16	2 years (study RCT end point)	265	62.5 (21.3)	9.6 (14.9) <sup>b,d</sup> (vs. MTX)	–52.9 (NR)	NR
COMET <sup>83</sup>	MTX + PBO	Week 52	263	65.1 (20.8)	33.7 (27.5)	–31.4	NR
COMET <sup>81</sup>	ETN + MTX	Week 52	265	66.0 (21.4)	24.1(24.2)	–41.9 <sup>b</sup>	NR
GO-BEFORE <sup>90</sup>	PBO + MTX	24 weeks	160	(0–10 scale); 6.3 (2.12)	NR	NR	44.35 <sup>a,e</sup>
GO-BEFORE <sup>90</sup>	GOL 50 mg s.c. every 4 weeks + MTX	24 weeks	159	(0–10 scale); 6.4 (2.11)	NR	NR	52.15 <sup>a,c,e</sup>

Trial name/ study	Treatment arms for which data extraction performed	Assessment time point	<i>n</i> analysed	Mean pain VAS score at baseline, 0–100 (SD)	Mean pain VAS score at follow-up, 0–100 (SD)	Pain VAS mean change from baseline (SD)	Mean % change from baseline
BeST <sup>148</sup>	Sequential monotherapy (DAS steered)	6 months	NR	53.1 (NR)	35.7 (NR)	-17.4	NR
BeST <sup>78</sup>	Step-up combination therapy (DAS steered)	6 months	NR	53.4 (NR)	27.9 (NR)	-25.5	NR
BeST <sup>78</sup>	Initial combination therapy with prednisone (DAS steered)	6 months	NR	54.1 (NR)	23.8 (NR)	-30.3 <sup>c</sup>	NR
BeST <sup>78</sup>	Initial combination therapy with IFX (DAS steered)	6 months	NR	54.1 (NR)	23.9 (NR)	-30.2 <sup>c</sup>	NR

OPTIMA, OPTimal protocol for treatment initiation with Methotrexate and Adalimumab; NR, not reported.  
 ADA = ADA 40 mg every other week subcutaneously.  
 ETN = ETN 25 mg twice a week subcutaneously.  
 GOL = GOL 50 mg every 4 weeks subcutaneously.  
 a *p* < 0.05.  
 b Median (5th, 95th centile range).  
 c *p* < 0.01.  
 d Mixed-model repeated measures analyses.  
 e Median % change.

TABLE 365 Pain VAS: populations 2 and 3 biologic head to head

Trial name/ study	Treatment arms for which data extraction performed	Assessment time point	<i>n</i> analysed	Mean pain VAS score at baseline, 0–100 (SD)	Mean pain VAS score at follow-up, 0–100 (SD)	Pain VAS mean change from baseline (SD)	Mean % change from baseline
AMPLE <sup>66</sup>	ABT s.c.	1 year (primary end point)	318	63.1 (22.3)	NR	NR	53
AMPLE <sup>144</sup>	ADA	1 year (primary end point)	328	65.5 (21.8)	NR	NR	39.2
deFilippis <i>et al.</i> , 2006 <sup>85</sup>	ETN + MTX	22 weeks	15	60.67 (16.57)	NR	NR	28.6
deFilippis <i>et al.</i> , 2006 <sup>85</sup>	IFX + MTX	22 weeks	15	70.10 (14.14)	NR	NR	22
deFilippis <i>et al.</i> , 2006 <sup>85</sup>	ETN + MTX	54 weeks	15	60.67 (16.57)	77.54	16.87 (NR)	43.06
deFilippis <i>et al.</i> , 2006 <sup>85</sup>	IFX + MTX	54 weeks	15	70.10 (14.14)	87.75	17.65 (NR)	21.1

NR, not reported.  
 ABT s.c. = ABT 125 mg once per week subcutaneously, following an optional i.v. loading dose of ≈10 mg/kg based on weight range.  
 ETN = ETN 25 mg twice a week subcutaneously.  
 IFX = IFX 3 mg/kg intravenously at weeks 0, 2, 6 and every 8 weeks thereafter (with dose escalation permitted after week 12 if lack of response).

TABLE 366 Pain VAS: populations 2 and 3 biologic vs. DMARD(s) or PBO

Trial name/ study	Treatment arms for which data extraction performed	Assessment time point	<i>n</i> analysed	Mean Pain VAS score at baseline, 0–100 (SD)	Mean Pain VAS score at follow-up, 0–100 (SD)	Pain VAS mean change from baseline (SD)	Mean % change from baseline
AIM <sup>61,62</sup>	MTX + PBO	12 months	219	65.9 (20.6)	NR	Adjusted –24.2 (1.72)	NR
AIM <sup>61</sup>	ABT i.v. + MTX	12 months	433	63.3 (21.1)	NR	Adjusted –35.8 (1.12)	NR
ASSURE <sup>73</sup>	PBO + cDMARDs	1 year (primary end point and study RCT end point)	413	61.3 (20.8) ( <i>n</i> = 418)	NR	NR	18
ASSURE <sup>73</sup>	ABT + cDMARDs	1 year (primary end point and study RCT end point)	845	61.1 (20.4) ( <i>n</i> = 856)	NR	NR	37
CHANGE <sup>80</sup>	PBO ( <i>n</i> = 87)	24 weeks	87	62.7 (22.8)	66.2 (NR)	3.5 (25.4)	NR
CHANGE <sup>80</sup>	ADA monotherapy ( <i>n</i> = 91)	24 weeks	91	68.1 (21)	50.7 (NR)	–17.4 (27.9) <sup>a</sup>	NR
DE019 <sup>84</sup>	MTX + PBO ( <i>n</i> = 200)	52 weeks	200	56.3 (22.9)	45.1 (NR)	–11.2 (27.7)	–19.9
DE01984	ADA + MTX ( <i>n</i> = 207)	52 weeks	207	55.9 (20.4)	26.5 (NR)	–29.4 (26.4)	–52.6
Van De Putte <i>et al.</i> , 2004 <sup>122</sup>	PBO s.c.	26 weeks	110	70.2 (18.1)	59.2 (NR)	–11.0 (26.7)	–11.4
Van De Putte <i>et al.</i> , 2004 <sup>122</sup>	ADA 40 mg s.c. every other week monotherapy	26 weeks	113	70.3 (19.9)	42.7 (NR)	–27.6 (31.1) <sub>b (vs. PBO)</sub>	–37.7 <sub>b (vs. PBO)</sub>
ARMADA <sup>69,70</sup>	MTX + PBO ( <i>n</i> = 62)	24 weeks	62	57.2 (21)	48.6 (NR)	–8.6 (22.5)	–15.0
ARMADA <sup>69</sup>	ADA + MTX ( <i>n</i> = 67)	24 weeks	67	53 (22)	27.9 (NR)	–25.1 (33.1)	–47.2 <sup>b</sup>
Kim <i>et al.</i> , 2007 <sup>99</sup>	MTX + PBO rescue week 18 ( <i>n</i> = 63)	24 weeks	63	59.4 (18.6)	52.1 (NR)	–7.3 (27.5)	NR
Kim <i>et al.</i> , 2007 <sup>99</sup>	ADA + MTX ( <i>n</i> = 65; <i>n</i> = 64 at 24 weeks)	24 weeks	64	57.6 (18.2)	33.9 (NR)	–23.7 (22.86) <sup>b</sup>	NR
CERTAIN <sup>156</sup>	PBO + cDMARDs	24 weeks (primary end point and study RCT end point)	98	NR	NR	(AiC information has been removed)	NR
CERTAIN <sup>79</sup>	CTZ 400 mg at weeks 0, 2 and 4 then 200 mg every 2 weeks + DMARDs	24 weeks (primary end point and study RCT end point)	96	NR	NR	(AiC information has been removed)	NR

continued

TABLE 366 Pain VAS: populations 2 and 3 biologic vs. DMARD(s) or PBO (continued)

Trial name/ study	Treatment arms for which data extraction performed	Assessment time point	n analysed	Mean Pain VAS score at baseline, 0–100 (SD)	Mean Pain VAS score at follow-up, 0–100 (SD)	Pain VAS mean change from baseline (SD)	Mean % change from baseline
ADORE <sup>59,60</sup>	ETN monotherapy (n = 159)	16 weeks	140	62.7	33.3 (NR)	–29.40 (25.09)	NR
ADORE <sup>59</sup>	ETN + MTX (n = 155)	16 weeks	135	63.3	33.37 (NR)	–29.93 (27.25)	NR
ETN Study 309/ Combe <i>et al.</i> , 2006 <sup>86</sup> Combe <i>et al.</i> , 2009 <sup>89</sup>	SSZ + PBO (n = 50)	24 weeks	50	58.8 (20)	NR	NR	13.3
ETN Study 309/ Combe <i>et al.</i> , 2006 <sup>86</sup> Combe <i>et al.</i> , 2009 <sup>89</sup>	ETN + PBO (n = 103)	24 weeks	103	62.6 (21.7)	NR	NR	55.6 <sup>b</sup> vs. SSZ
ETN Study 309/ Combe <i>et al.</i> , 2006 <sup>88,89</sup>	ETN + SSZ (n = 101)	24 weeks	101	58.5 (20.7)	NR	NR	53.9 <sup>a</sup> vs. SSZ
JESMR <sup>140</sup>	ETN 25 mg every 2 weeks monotherapy	24 weeks (primary end point)	69	NR	NR	NR	NR
JESMR <sup>140</sup>	ETN 25 mg every 2 weeks + MTX 6–8 mg/week	24 weeks (primary end point)	73	NR	NR	NR	NR
Lan <i>et al.</i> , 2004 <sup>101</sup>	PBO + MTX	12 weeks (primary end point and study RCT end point)	29	57.52	57.59	0.07 (NR)	0.05
Lan <i>et al.</i> , 2004 <sup>101</sup>	ETN + MTX	12 weeks (primary end point and study RCT end point)	29	55.21	31.66 <sup>a</sup>	–23.55 (NR)	43
Moreland <i>et al.</i> , 1999 <sup>104</sup>	PBO	6 months	80	(0–10 scale) 6.5	NR	NR	22 (worse)
Moreland <i>et al.</i> , 1999 <sup>104</sup>	ETN + PBO	6 months	78	(0–10 scale) 6.7	NR	NR	–53 (improved) <sup>b</sup>



Trial name/ study	Treatment arms for which data extraction performed	Assessment time point	<i>n</i> analysed	Mean Pain VAS score at baseline, 0–100 (SD)	Mean Pain VAS score at follow-up, 0–100 (SD)	Pain VAS mean change from baseline (SD)	Mean % change from baseline
RACAT <sup>111</sup>	MTX + SSZ + HCQ ( <i>n</i> = 178; not all analysed)	24 weeks	319 both groups	5.64 (2.21)	3.64 (2.38)	-2.0 (NR)	NR
RACAT <sup>111</sup>	ETN50 + MTX ( <i>n</i> = 175; not all analysed)	24 weeks		5.88 (1.99)	3.56 (2.53)	-2.32 (NR)	NR
RACAT <sup>111</sup>	MTX + SSZ + HCQ ( <i>n</i> = 178 randomised)	48 weeks	155	NR	3.22 (2.37)	NR	NR
RACAT <sup>111</sup>	In analysis <i>n</i> = 155 (of whom 39 switched to ETN) ETN50 + MTX ( <i>n</i> = 175 randomised)	48 weeks	155	NR	3.17 (2.58)	NR	NR
Weinblatt <i>et al.</i> 1999 <sup>124</sup>	In analysis <i>n</i> = 155 (of whom 41 switched to MTX + SSZ + HCQ) MTX + PBO	24 weeks	30	(0–10 scale)	(0–10 scale)	-1.2 (NR)	NR
Weinblatt <i>et al.</i> 1999 <sup>124</sup>	ETN + MTX ( <i>n</i> = 59)	24 weeks	59	5.6 <sup>c</sup> (0–10 scale)	4.4 <sup>c</sup> (0–10 scale)	-3.2 (NR)	NR
APPEAL <sup>67,68</sup>	MTX + DMARD (SSZ, HCQ or LEF)	16 weeks (primary end point and study RCT end point)	103	5.0 <sup>c</sup> 60.8 (19.2)	1.8 <sup>b,c</sup> 38.6	-22.2 (NR)	36.5
APPEAL <sup>68</sup>	ETN 25 mg twice weekly (licensed dose) + MTX	16 weeks (primary end point and study RCT end point)	197	62.5 (23.4)	28.5 <sup>b</sup>	-34.0 (NR)	54.4 <sup>b</sup>
GO-FORWARD <sup>92</sup>	PBO s.c. every 4 weeks + MTX	Week 14	133	(0–10 scale) 5.70 (3.60, 7.50) <sup>c</sup>	NR	NR	17.6 (-8.1, 40.0) <sup>c</sup>
GO-FORWARD <sup>92</sup>	GOL 50 mg s.c. every 4 weeks + MTX	Week 14	89	(0–10 scale) 6.10 (4.70, 7.70) <sup>c</sup>	NR	NR	55.0 (17.0, 76.5) <sup>b,c</sup>
GO FORWARD <sup>92</sup>	PBO s.c. every 4 weeks + MTX	Week 24	133	(0–10 scale) 5.70 (3.60, 7.50) <sup>c</sup>	NR	NR	15.4 (-16.4, 41.6) <sup>c</sup>

continued

**TABLE 366 Pain VAS: populations 2 and 3 biologic vs. DMARD(s) or PBO (continued)**

Trial name/ study	Treatment arms for which data extraction performed	Assessment time point	n analysed	Mean Pain VAS score at baseline, 0–100 (SD)	Mean Pain VAS score at follow-up, 0–100 (SD)	Pain VAS mean change from baseline (SD)	Mean % change from baseline
GO FORWARD <sup>92</sup>	GOL 50 mg s.c. every 4 weeks + MTX	Week 24	89	(0–10 scale) 6.10 (4.70, 7.70) <sup>c</sup>	NR	NR	50.4 (16.3, 83.3) <sup>b,c</sup>
ATTRACT <sup>75</sup>	PBO i.v. + MTX	30 weeks	88	(0–10 scale)	(0–10 scale)	–0.8 (NR)	–6 <sup>d</sup>
ATTRACT <sup>75</sup>	IFX 3 mg/kg i.v. at weeks 0, 2 and 6 and every 8 weeks thereafter	30 weeks	86	6.7 (5.0, 8.0) <sup>c</sup> (0–10 scale)	5.9 (3.3, 7.4) <sup>c</sup> (0–10 scale)	–3.2 (NR)	–33 <sup>a,d</sup>
START <sup>118</sup>	PBO + MTX	22 weeks (primary end point and study RCT end point)	363	7.0 (5.6, 8.1) <sup>c</sup> (0–10 scale)	NR	NR	NR
START <sup>118</sup>	IFX 3 mg/kg + MTX	22 weeks (primary end point and study RCT end point)	360	5.9 (5–7) <sup>e</sup> (0–10 scale)	NR	NR	NR
ACT-RAY <sup>57</sup>	TCZ 8 mg/kg i.v. every 4 weeks + oral PBO	Week 24	276	NR	NR	–29.8 (24.92)	NR
ACT-RAY <sup>57</sup>	TCZ 8 mg/kg i.v. every 4 weeks + MTX	Week 24	277	NR	NR	–29.3 (26.64)	NR

AIM, Abatacept in Inadequate responders to Methotrexate; CHANGE, Clinical investigation in Highly disease-affected rheumatoid Arthritis patients in Japan with Adalimumab applying standard and General Evaluation study; ETN50, etanercept 50 mg once a week subcutaneously; NR, not reported.

ABT i.v. = BT ≈10 mg/kg intravenously on weeks 0, 2 and 4, and every 4 weeks thereafter.

ADA = ADA 40 mg every other week subcutaneously.

CTZ = s.c. CTZ 400 mg at weeks 1, 2 and 4, then 200 mg every other week.

GOL = GOL 50 mg every 4 weeks subcutaneously.

IFX = IFX 3 mg/kg intravenously at weeks 0, 2, 6 and every 8 weeks thereafter (with dose escalation permitted after week 12 if lack of response).

TCZ = TCZ 8 mg/kg intravenously every 4 weeks.

a  $p < 0.05$ .

b  $p < 0.01$ .

c Median (5th, 95th centile range).

d Median % change.

e Median (interquartile range).

Data are shown to the level of accuracy available in the source material.

**TABLE 367** The 0–100 VAS of fatigue: population 1 RCTs of biologic vs. DMARD(s) or PBO

Trial name	Treatment arms for which data extraction performed	Assessment point	Mean score at baseline	Mean score at follow-up	Mean change from baseline
COMET <sup>83</sup>	MTX	52 weeks	NR	NR	–19.7
	ETN + MTX	52 weeks	NR	NR	–29.6 <sup>a</sup>

NR, not reported.  
 ETN = ETN 25 mg twice a week subcutaneously.  
 a  $p < 0.001$ .

**TABLE 368** Functional Assessment of Chronic Illness Therapy – Fatigue score (0–52, higher scores indicate less fatigue): population 1 RCTs of biologic vs. DMARD(s) or PBO

Trial name	Treatment arms for which data extraction performed	Assessment point	Mean (SD) score at baseline	Mean (SD) score at follow-up	Mean (SD) change from baseline	% change from baseline
OPTIMA <sup>154</sup>	MTX + PBO	26 weeks	NR	NR	8.3 (11.12)	NR
	ADA + MTX	26 weeks	NR	NR	10.5 (11.82) <sup>a</sup>	NR
PREMIER <sup>155</sup>	MTX + PBO	1 year	29.0 (11.1)	40.0 (8.10)	11.0 (NR)	NR
	ADA monotherapy + PBO step-up week 16	1 year	26.2 (11.3) <sup>a,b</sup> (vs. MTX)	38.6 (8.0)	12.4 (NR)	NR
	ADA + MTX step-up week 16	1 year	28.4 (11.7)	41.1 (8.2) <sup>b,c</sup> (vs. MTX)	12.7 (NR)	NR
PREMIER <sup>155</sup>	MTX + PBO	2 years	29.0 (11.1)	42.5 (8.1)	13.5 (NR)	NR
	ADA monotherapy + PBO step-up week 16	2 years	26.2 (11.3) <sup>a,b</sup> (vs. MTX)	40.8 (8.1)	14.6 (NR)	NR
	ADA + MTX step-up week 16	2 years	28.4 (11.7)	43.0 (8.1) <sup>b,c</sup> (vs. MTX)	14.6 (NR)	NR

OPTIMA, OPTimal protocol for treatment Initiation with Methotrexate and Adalimumab; NR, not reported.  
 ADA = ADA 40 mg every other week subcutaneously.  
 a  $p < 0.05$ .  
 b Significant in a mixed-model repeated measures analysis.  
 c  $p < 0.001$ .

**TABLE 369** The 0–100 VAS of fatigue: populations 2 and 3 biologic head-to-head RCTs

Trial name	Treatment arms for which data extraction performed	Assessment point	Mean score at baseline	Mean score at follow-up	Mean change from baseline
AMPLE <sup>144</sup>	ABT s.c. + MTX	1 year	NR	NR	–23.2
	ADA + MTX	1 year	NR	NR	–23.2

NR, not reported.  
 ABT s.c. = ABT 125 mg once per week subcutaneously, following an optional i.v. loading dose of ≈10 mg/kg based on weight range.  
 ADA = ADA 40 mg every other week subcutaneously.

**TABLE 370** Functional Assessment of Chronic Illness Therapy – Fatigue score (0–52, higher scores indicate less fatigue): populations 2 and 3 biologic head-to-head RCTs

Trial name	Treatment arms for which data extraction performed	Assessment point	Mean score at baseline	Mean score at follow-up	Mean change from baseline	% change from baseline
ADACTA <sup>58</sup>	TCZ 8 mg/kg i.v. every 4 weeks + s.c. PBO ADA	24 weeks	NR	NR	8.9 <sup>a</sup>	NR
	ADA 40 mg s.c. every 2 weeks + i.v. PBO TCZ	24 weeks	NR	NR	11.4 <sup>a</sup>	NR

NR, not reported.  
 ADA = ADA 40 mg every other week subcutaneously.  
 TCZ = TCZ 8 mg/kg intravenously every 4 weeks.  
 a Adjusted mean change from baseline.

**TABLE 371** The 0–100 VAS of fatigue: populations 2 and 3 RCTs of biologic vs. DMARD(s) or PBO

Trial name	Treatment arms for which data extraction performed	Assessment point	Mean score at baseline	Mean score at follow-up	Mean change from baseline
AIM <sup>63</sup>	MTX + PBO	1 year	63.5	40.9 (NR)	–22.6
	ABT + PBO	1 year	65.3	37.3 (NR)	–28.0 <sup>a</sup>

AIM, Abatacept in Inadequate responders to Methotrexate; NR, not reported.  
 ABT i.v. = BT ≈ 10 mg/kg intravenously on weeks 0, 2 and 4, and every 4 weeks thereafter.  
 a  $p < 0.05$ .

**TABLE 372** Functional Assessment of Chronic Illness Therapy – Fatigue score (0–52, higher scores indicate less fatigue): populations 2 and 3 RCTs of biologic vs. DMARD(s) or PBO

Trial name	Treatment arms for which data extraction performed	Assessment point	Mean (SD) score at baseline	Mean (SD) score at follow-up	Mean (SD) change from baseline	% change from baseline
ARMADA <sup>69,70</sup>	MTX + PBO	24 weeks	NR	NR	3.0 improvement	NR
	ADA + MTX	24 weeks	NR	NR	8.5 <sup>a</sup> improvement	NR
APPEAL <sup>68</sup>	MTX + DMARD (SSZ, HCQ or LEF)	16 weeks	30.1	33.2	3.1 (NR)	10.4
	ETN + MTX	16 weeks	28.1	36.2 <sup>a</sup>	8.1 (NR)	28.0 <sup>a</sup>
GO-FORWARD <sup>92</sup>	PBO + MTX	Week 24	28.7 (10.5)	30.86 (NR)	2.16 (9.53)	NR
	GOL 50 mg + MTX	Week 24	26.6 (11.0)	33.9 (NR)	7.30 (8.65) <sup>b</sup>	NR
TOWARD <sup>121</sup>	PBO + cDMARDs	24 weeks	NR	NR	3.6	NR
	TCZ 8 mg/kg i.v. + DMARDs	24 weeks	NR	NR	8.0 <sup>b</sup>	NR

NR, not reported.

ADA = ADA 40 mg every other week subcutaneously.

CTZ = s.c. CTZ 400 mg at weeks 1, 2 and 4, then 200 mg every other week.

ETN = ETN 25 mg twice a week subcutaneously.

GOL = GOL 50 mg every 4 weeks subcutaneously.

TCZ = TCZ 8 mg/kg intravenously every 4 weeks.

<sup>a</sup>  $p < 0.05$ .

<sup>b</sup>  $p < 0.001$ .

Data are shown to the level of accuracy available in the source material.

TABLE 373 The 0–100 SF-36 components scores: population 1 RCTs of biologic vs. DMARD(s) or PBO

Trial name	Treatment arms for which data extraction performed	Assessment point	Mean (SD) PCS at baseline	Mean (SD) PCS at follow-up	Mean (SD) change from baseline in PCS	Mean (SD) MCS at baseline	Mean (SD) MCS at follow-up	Mean (SD) change from baseline in MCS	Mean (SD) ASHI score at baseline	Mean (SD) ASHI at follow-up	Mean (SD) change from baseline in ASHI score
HIT HARD <sup>54</sup>	MTX + PBO	24 weeks	31.7 (8.3)	39.8 (9.9)	8.1 (NR)	45.2 (10.2)	48.9 (8.8)	3.7 (NR)	NR	NR	NR
	ADA + MTX	24 weeks	28.3 (7.7) <sup>a</sup>	44.0 (11.1) <sup>b</sup>	15.7 (NR)	46.7 (9.9)	48.8 (9.8)	2.1 (NR)	NR	NR	NR
PREMIER <sup>155</sup>	MTX + PBO	1 year	32.2 (7.9)	43.5 (8.1)	11.3 (NR)	43.5 (12.4)	51.3 (8.5)	7.8 (NR)	NR	NR	NR
	ADA monotherapy + PBO step-up week 16	1 year	30.7 (7.4)	42.5 (7.9)	11.8 (NR)	42.6 (12.1)	49.1 (8.2) <sup>ac</sup>	6.5 (NR)	NR	NR	NR
	ADA + MTX step-up week 16	1 year	31.7 (7.8)	46.6 (8.2) <sup>bc</sup> (vs. MTX)	14.9 (NR)	44.1 (12.5)	50.7 (8.7)	6.6 (NR)	NR	NR	NR
PREMIER <sup>155</sup>	MTX + PBO	2 years	32.2 (7.9)	45.9 (7.8)	13.7 (NR)	43.5 (12.4)	52.4 (8.4)	8.9 (NR)	NR	NR	NR
	ADA monotherapy + PBO step-up week 16	2 years	30.7 (7.4)	44.7 (8.0)	14 (NR)	42.6 (12.1)	49.8 (8.1) <sup>ac</sup> (vs. MTX)	7.2 (NR)	NR	NR	NR
	ADA + MTX step-up week 16	2 years	31.7 (7.8)	48.8 (8.3) <sup>bc</sup> (vs. MTX)	17.1 (NR)	44.1 (12.5)	51.8 (8.8)	7.7 (NR)	NR	NR	NR
COMET <sup>83</sup>	MTX	52 weeks	NR	NR	10.7	NR	NR	6.1	NR	NR	NR
	ETN + MTX	52 weeks	NR	NR	13.7 <sup>a</sup>	NR	NR	6.8	NR	NR	NR
ERA <sup>157</sup>	MTX + PBO	52 weeks	NR	NR	9.6 (0.8) <sup>d</sup>	NR	NR	4.1 (0.8) <sup>d</sup>	NR	NR	8.1 (1.0) <sup>d</sup>
	ETN 25 mg every 2 weeks + PBO	52 weeks	NR	NR	10.7 (0.8) <sup>d</sup>	NR	NR	3.6 (0.8) <sup>d</sup>	NR	NR	8.2 (1.0) <sup>a,d</sup>
ASPIRE <sup>71</sup>	PBO i.v. + MTX	54 weeks	NR	NR	10.1 (11.4)	NR	NR	NR	NR	NR	NR
	IFX i.v. + MTX	54 weeks	NR	NR	11.7 (11.6)	NR	NR	NR	NR	NR	NR

Trial name	Treatment arms for which data extraction performed	Assessment point	Mean (SD) PCS at baseline	Mean (SD) PCS at follow-up	Mean (SD) change from baseline in PCS	Mean (SD) MCS at baseline	Mean (SD) MCS at follow-up	Mean (SD) change from baseline in MCS	Mean (SD) ASHI score at baseline	Mean (SD) ASHI at follow-up	Mean (SD) change from baseline in ASHI score
BeST <sup>78</sup>	Sequential monotherapy	6 months	NR	NR	8.0 <sup>b</sup> (vs. combination +prednisone and combination+IFX)	NR	NR	3.1	NR	NR	NR
	Step-up combination therapy	6 months	NR	NR	8.5 <sup>b</sup> (vs. combination +prednisone and combination+IFX)	NR	NR	3.5	NR	NR	NR
	Initial combination therapy with prednisone	6 months	NR	NR	12.5	NR	NR	1.2	NR	NR	NR
	Initial combination therapy with IFX	6 months	NR	NR	12.4	NR	NR	4.1	NR	NR	NR

ASHI, Arthritis-Specific Health Index; ASPIRE, Active controlled Study of Patients receiving Infliximab for the treatment of Rheumatoid arthritis of Early onset; ERA, Early Rheumatoid Arthritis (etanercept); HIT HARD, High Induction Therapy with Anti-Rheumatic Drugs (adalimumab and methotrexate); MCS, mental component score; NR, not reported; PCS, physical component score.

ADA = ADA 40 mg every other week subcutaneously.  
 ETN = ETN 25 mg twice a week subcutaneously.  
 IFX = IFX 3 mg/kg intravenously at weeks 0, 2, 6 and every 8 weeks thereafter (with dose escalation permitted after week 12 if lack of response).  
 TCZ = TCZ 8 mg/kg intravenously every 4 weeks.

a  $p < 0.05$ .  
 b  $p < 0.001$ .  
 c Estimated from graphical data.  
 d Mean change from baseline (SE).

**TABLE 374** The 0–100 SF-36 domains scores: baseline and follow-up – population 1 RCTs of biologic vs. DMARD(s) or PBO

Trial name	Treatment arms for which data extraction performed	Assessment point	Mean (SD) PF score at baseline	Mean (SD) PF score at follow-up	Mean (SD) RP score at baseline	Mean (SD) RP score at follow-up	Mean (SD) BP score at baseline	Mean (SD) BP score at follow-up	Mean (SD) GH score at baseline
PREMIER <sup>155</sup>	MTX + PBO	1 year	31.5 (10.3)	41.8 (9.7)	32.6 (8.4)	44.1 (8.9)	32.7 (7.7)	46.5 (7.3)	40.5 (9.1)
	ADA monotherapy + PBO step-up week 16	1 year	29.1 (9.5)	40.5 (9.0)	32.5 (8.1)	43.3 (8.0)	31.6 (7.8)	44.9 (6.9) <sup>a,b</sup>	39.8 (9.6)
	ADA + MTX step-up week 16	1 year	30.2 (10.0)	44.7 (9.2) <sup>b,c</sup>	33.1 (8.8)	46.6 (8.2) <sup>b,c</sup>	32.5 (7.1)	49.7 (7.3) <sup>b,c</sup>	40.9 (10.0)
PREMIER <sup>155</sup>	MTX + PBO	2 years	31.5 (10.3)	44.3 (9.3)	32.6 (8.4)	46.5 (8.6)	32.7 (7.7)	48.8 (7.1)	40.5 (9.1)
	ADA monotherapy + PBO step-up week 16	2 years	29.1 (9.5)	43.0 (9.1)	32.5 (8.1)	45.5 (8.0)	31.6 (7.8)	47.1 (6.9) <sup>a,b</sup>	39.8 (9.6)
	ADA + MTX step-up week 16	2 years	30.2 (10.0)	46.9 (9.2) <sup>b,c</sup>	33.1 (8.8)	48.8 (8.2) <sup>b,c</sup>	32.5 (7.1)	51.8 (7.2) <sup>b,c</sup>	40.9 (10.0)

BP, bodily pain; GH, general health; MH, mental health; PF, physical functioning; RE, role–emotional; RP, role–physical; SF, social functioning; VT, vitality.

ADA = ADA 40 mg every other week subcutaneously.

a  $p < 0.05$ .

b Estimated from graphical data.

c  $p < 0.001$ .



Mean (SD) GH score at follow-up	Mean (SD) VT score at baseline	Mean (SD) VT score at follow-up	Mean (SD) SF score at baseline	Mean (SD) SF score at follow-up	Mean (SD) RE score at baseline	Mean (SD) RE score at follow-up	Mean (SD) MH score at baseline	Mean (SD) MH score at follow-up
46.4 (8.2)	40.6 (9.7)	51.8 (8.7)	38.1 (12.2)	47.9 (7.8)	36.7 (13.8)	46.2 (8.6)	42.6 (12.1)	50.0 (9.0)
45.4 (7.9) <sup>a,b</sup>	39.2 (9.4)	49.6 (8.3) <sup>a,b</sup>	35.2 (12.2)	45.9 (7.4) <sup>a,b</sup>	37.5 (13.9)	44.5 (7.9) <sup>a,b</sup>	41.4 (11.9)	48.0 (8.7)
48.2 (8.2)	40.0 (10.0)	52.9 (8.8) <sup>a,b</sup>	38.3 (12.0)	48.7 (7.4)	38.4 (14.1)	47.3 (8.1)	42.1 (12.2)	49.9 (8.8)
47.2 (8.2)	40.6 (9.7)	53.7 (8.5)	38.1 (12.2)	49.2 (7.6)	36.7 (13.8)	48.1 (8.0)	42.6 (12.1)	51.1 (9.3)
46.7 (8.1) <sup>a,b</sup>	39.2 (9.4)	51.4 (8.4) <sup>a,b</sup>	35.2 (12.2)	48.0 (7.6) <sup>a,b</sup>	37.5 (13.9)	45.8 (7.9) <sup>a,b</sup>	41.4 (11.9)	49.2 (8.7)
49.5 (8.3)	40.0 (10.0)	54.7 (9.0) <sup>a,b</sup>	38.3 (12.0)	49.9 (7.4)	38.4 (14.1)	49.1 (7.8)	42.1 (12.2)	51.1 (8.7)

TABLE 375 The 0–100 SF-36 domains scores: mean change from baseline – population 1 RCTs of biologic vs. DMARD(s) or PBO

Trial name	Treatment arms for which data extraction performed	Assessment point	Mean (SD) change from baseline in PF score	Mean (SD) change from baseline in RP score	Mean (SD) change from baseline in BP score	Mean (SD) change from baseline in GH score	Mean (SD) change from baseline in VT score	Mean (SD) change from baseline in SF score	Mean (SD) change from baseline in RE score	Mean (SD) change from baseline in MH score
ERA <sup>157</sup>	MTX + PBO	52 weeks	10.4 (0.8)	9.9 (0.9)	10.1 (0.7)	3.4 (0.7)	6.8 (0.8)	8.1 (0.9)	4.7 (1.0)	5.8 (0.8)
	ETN 25 mg every 2 weeks + PBO	52 weeks	9.7 (0.8)	10.8 (0.9)	10.5 (0.8)	4.5 (0.7)	7.9 (0.8)	8.4 (0.9)	4.0 (1.1)	4.4 (0.8)

BP, bodily pain; ERA, Early Rheumatoid Arthritis (etanercept); GH, general health; MH, mental health; PF, physical functioning; RP, role-physical; SF, social functioning; VT, vitality  
ETN = ETN 25 mg twice a week subcutaneously.

**TABLE 376** The 0–100 Short Form questionnaire-12 items components scores: population 1 RCTs of biologic vs. DMARD(s) or PBO

Trial name	Treatment arms for which data extraction performed	Assessment point	Mean (SD) PCS at baseline (0–100)	Mean (SD) PCS at follow-up (0–100)	Mean (SD) change from baseline in PCS (0–100)	Mean (SD) MCS at baseline (0–100)	Mean (SD) MCS at follow-up (0–100)	Mean (SD) change from baseline in MCS (0–100)
OPERA <sup>107</sup>	MTX + PBO + steroid ADA + MTX + steroid	12 months 12 months	31.7 (19.3, 44.5) <sup>a</sup> 30.9 (13.1, 50.6) <sup>a</sup>	43.3 (26.1, 55.8) <sup>a</sup> 49.2 (29.9, 56.6) <sup>a,b</sup>	10.6 (–11.26, 22.7) <sup>a</sup> 13.2 (–2.3, 33.0) <sup>a,b</sup>	46.7 (25.7, 60.1) <sup>a</sup> 47.0 (28.6, 60.6) <sup>a</sup>	54.8 (40.4, 65.7) <sup>a</sup> 55.7 (35.8, 62.6) <sup>a</sup>	4.3 (–9.3, 27.4) <sup>a</sup> 5.5 (–8.5, 20.1) <sup>a</sup>

MCS, mental component score; PCS, physical component score.  
 ADA = ADA 40 mg every other week subcutaneously.  
 a Median (5th, 95th percentile range).  
 b  $p < 0.05$ .

**TABLE 377** The 0–100 SF-6D and RAQoL: population 1 RCTs of biologic vs. DMARD(s) or PBO

Trial name/ study	Treatment arms for which data extraction performed	Assessment point	Mean (SD) SF-6D score at baseline	Mean (SD) SF-6D score at follow-up	Mean (SD) change from baseline in RAQoL score	% change from baseline in RAQoL score
Bejarano <i>et al.</i> , 2008 <sup>77</sup>	PBO + MTX	56 weeks	NR	NR	−4.7 (8.4)	NR
	ADA + MTX	56 weeks	NR	NR	−7.6 (7.4) <sup>a</sup>	NR
PREMIER <sup>155</sup>	MTX + PBO	1 year	0.56 (0.11)	0.72 (0.14)	NR	NR
	ADA monotherapy + PBO step-up week 16	1 year	0.54 (0.11)	0.70 (0.14) <sup>a,b</sup>	NR	NR
	ADA + MTX step-up week 16	1 year	0.45 (0.11)	0.75 (0.13) <sup>a,b</sup>	NR	NR
PREMIER <sup>155</sup>	MTX + PBO	2 years	0.56 (0.11)	0.73 (0.14)	NR	NR
	ADA monotherapy + PBO step-up week 16	2 years	0.54 (0.11)	0.70 (0.13) <sup>a,b</sup>	NR	NR
	ADA + MTX step-up week 16	2 years	0.45 (0.11)	0.76 (0.14) <sup>a,b</sup>	NR	NR
Quinn <i>et al.</i> , 2005 <sup>110</sup>	MTX + PBO	14 weeks	NR	NR	NR	7 <sup>b</sup> (worse)
	IFX 3 mg/kg + MTX	14 weeks	NR	NR	NR	−74 <sup>a,b</sup> (improved)
Quinn <i>et al.</i> , 2005 <sup>110</sup>	MTX + PBO	54 weeks	NR	NR	NR	0 <sup>b</sup>
	IFX 3 mg/kg + MTX	54 weeks	NR	NR	NR	−82 <sup>a,b</sup> (improved)

NR, not reported.

ADA = ADA 40 mg every other week subcutaneously.

IFX = IFX 3 mg/kg intravenously at weeks 0, 2, 6 and every 8 weeks thereafter (with dose escalation permitted after week 12 if lack of response).

a  $p < 0.05$ .

b Estimated from graphical data.

**TABLE 378** The 0–100 EQ-5D: population 1 RCTs of biologic vs. DMARD(s) or PBO

Trial name	Treatment arms for which data extraction performed	Assessment point	Mean EQ-5D score at baseline (0–1)	Mean EQ-5D score at follow-up (0–1)	Mean (SD) change from baseline in EQ-5D score (0–1)
OPERA <sup>107</sup>	MTX + PBO + steroid	12 months	0.64 (0.22, 0.80) <sup>a</sup>	0.78 (0.49, 1.00) <sup>a</sup>	0.20 (–0.06, 0.56) <sup>a</sup>
	ADA + MTX + steroid	12 months	0.61 (0.17, 0.80) <sup>a</sup>	0.82 (0.38, 1.00) <sup>a,b</sup>	0.22 (–0.05, 0.67) <sup>a</sup>
BeST <sup>158</sup>	Sequential monotherapy	6 months	0.5 <sup>c</sup>	0.65 <sup>c</sup>	–0.15 (NR)
	Step-up combination therapy	6 months	0.5 <sup>c</sup>	0.6 <sup>c</sup>	–0.1 (NR)
	Initial combination therapy with prednisone	6 months	0.5 <sup>c</sup>	0.75 <sup>c</sup>	–0.25 (NR)
	Initial combination therapy with IFX	6 months	0.5 <sup>c</sup>	0.8 <sup>c</sup>	–0.03 (NR)

NR, not reported.

ADA = ADA 40 mg every other week subcutaneously.

IFX = IFX 3 mg/kg intravenously at weeks 0, 2, 6 and every 8 weeks thereafter (with dose escalation permitted after week 12 if lack of response).

a Median (5th, 95th percentile range).

b  $p < 0.05$ .

c Estimated from graphical data.

Data are shown to the level of accuracy available in the source material.

TABLE 379 The 0–100 SF-36 components scores: populations 2 and 3 biologic head-to-head RCTs

Trial name	Treatment arms for which data extraction performed	Assessment point	Mean PCS at baseline	Mean PCS at follow-up	Mean change from baseline in PCS	Mean MCS at baseline	Mean MCS at follow-up	Mean change from baseline in MCS
ATTEST <sup>74</sup>	PBO + MTX	Day 197	NR	NR	4 <sup>a</sup>	NR	NR	1 <sup>a</sup>
	IFX + MTX	Day 197	NR	NR	7 <sup>a</sup>	NR	NR	4 <sup>a</sup>
	ABT + MTX	Day 197	NR	NR	8 <sup>a</sup>	NR	NR	5 <sup>a</sup>
AMPLE <sup>144</sup>	ABT s.c. + MTX	1 year	NR	NR	9.37	NR	NR	3.92
	ADA + MTX	1 year	NR	NR	8.84	NR	NR	3.62
ADACTA <sup>58</sup>	TCZ 8 mg/kg i.v. every 4 weeks + s.c. PBO ADA	24 weeks	NR	NR	9.2	NR	NR	7.9
	ADA 40 mg s.c. every 2 weeks + i.v. PBO TCZ	24 weeks	NR	NR	7.6	NR	NR	5.0 <sup>b</sup>

MCS, mental component score; NR, not reported; PCS, physical component score.

ABT i.v. = BT ≈10 mg/kg intravenously on weeks 0, 2 and 4, and every 4 weeks thereafter.

ABT s.c. = ABT 125 mg once per week subcutaneously, following an optional i.v. loading dose of ≈10 mg/kg based on weight range.

ADA = ADA 40 mg every other week subcutaneously.

TCZ = TCZ 8 mg/kg intravenously every 4 weeks.

<sup>a</sup> Estimated from graphical data.

<sup>b</sup>  $p < 0.05$ .

Data are shown to the level of accuracy available in the source material.

**TABLE 380** The 0–100 SF-36 domains scores: mean change from baseline – populations 2 and 3 biologic head-to-head RCTs

Trial name	Treatment arms for which data extraction performed	Assessment point	Mean change from baseline in PF score	Mean change from baseline in RP score	Mean change from baseline in GH score	Mean change from baseline in VT score	Mean change from baseline in SF score	Mean change from baseline in RE score	Mean change from baseline in MH score	
AMPLE <sup>66</sup>	ABT s.c. + MTX	1 year	7.92	8.87	10.67	5.44	5.84	7.33	6	4.21
	ADA + MTX	1 year	7.81	7.91	10.65	5.26	5.51	6.5	5.84	3.86

BP, bodily pain; GH, general health; MH, mental health; PF, physical functioning; RE, role-emotional; RP, role-physical; SF, social functioning; VT, vitality.  
 ABT s.c. = ABT 125 mg once per week subcutaneously, following an optional i.v. loading dose of  $\approx 10$  mg/kg based on weight range.  
 ADA = ADA 40 mg every other week subcutaneously.  
 Data are shown to the level of accuracy available in the source material.

**TABLE 381** The 0–100 EQ-5D utility score: populations 2 and 3 biologic head-to-head RCTs

Trial name	Treatment arms for which data extraction performed	Assessment point	Mean EQ-5D score at baseline (0–1)	Mean (SD) EQ-5D score at follow-up (0–1)	Mean (SD) change from baseline in EQ-5D score (0–1)
RED-SEA <sup>114</sup>	ADA ( $n = 60$ )	12 months	0.52 (0.06–0.66) <sup>a</sup>	0.59 (0.52–0.69)	0.07 (NR)
	ETN ( $n = 60$ )	12 months	0.52 (0.06–0.69) <sup>a</sup>	0.59 (0.24–0.73)	0.07 (NR)

NR, not reported.  
 ADA = ADA 40 mg every other week subcutaneously.  
 ETN = ETN 25 mg twice a week subcutaneously.  
 a Median (IQR).

TABLE 382 The 0–100 SF-36 components scores: populations 2 and 3 RCTs of biologic vs. DMARD(s) or PBO

Trial name	Treatment arms for which data extraction performed	Assessment point	Mean (SD) PCS at baseline	Mean (SD) PCS at follow-up	Mean (SD) change from baseline in PCS	% change from baseline in PCS	Mean (SD) MCS at baseline	Mean (SD) MCS at follow-up	Mean (SD) change from baseline in MCS	Mean % change from baseline in MCS
AIM <sup>61,62</sup>	MTX + PBO	1 year	30.7 (7.5)	35 <sup>a</sup>	4.3 (NR)	NR	40.8 (11.2)	46 <sup>a</sup>	5.2 (NR)	NR
	ABT + PBO	1 year	30.6 (7.3)	40 <sup>a,b</sup>	9.4 (NR)	NR	41.8 (11.4)	49 <sup>a,c</sup>	7.2 (NR)	NR
CERTAIN <sup>79</sup>	PBO + cDMARDs	24 weeks	NR	NR	1.7 (5.6)	NR	NR	NR	0.5 (9.6)	NR
ClinicalTrials.gov (NCT00674362)	CTZ + cDMARDs	24 weeks	NR	NR	6.0 (7.50)	NR	NR	NR	4.0 (9.77)	NR
APPEAL <sup>68</sup>	MTX + DMARD (SSZ, HCQ or LEF)	16 weeks	30.1	37.3	7.2 (NR)	22.8 improvement	42.4	47.8	5.4 (NR)	13.3 improvement
	ETN + MTX	16 weeks	30.5	40.4 <sup>b</sup>	9.9 (NR)	31.4 <sup>b</sup> improvement	42.9	50.2 <sup>c</sup>	7.3 (NR)	17.5 <sup>c</sup> improvement
GO-FORWARD <sup>92</sup>	PBO + MTX	Week 24	NR	NR	2.54 (8.06) improvement	NR	NR	NR	0.75 (9.68) improvement	NR
	GOL 50 mg + MTX	Week 24	NR	NR	8.28 (8.33) <sup>b</sup> improvement	NR	NR	NR	1.83 (10.87) improvement	NR
ATTRACT <sup>159</sup>	PBO i.v. + MTX	54 week	NR	NR	NR	NR	NR	NR	NR	9 improvement
	IFX i.v. monotherapy	54 week	NR	NR	NR	NR	NR	NR	NR	34 <sup>b</sup> improvement
TOWARD <sup>121</sup>	PBO + cDMARDs	24 weeks	NR	NR	4.1 improvement	NR	NR	NR	2.3 improvement	NR
	TCZ 8 mg/kg i.v. + DMARDs	24 weeks	NR	NR	8.9 <sup>b</sup> improvement	NR	NR	NR	5.3 <sup>b</sup> improvement	NR



Trial name	Treatment arms for which data extraction performed	Assessment point	Mean (SD) PCS at baseline	Mean (SD) PCS at follow-up	Mean (SD) change from baseline in PCS	% change from baseline in PCS	Mean (SD) MCS at baseline	Mean (SD) MCS at follow-up	Mean (SD) change from baseline in MCS	Mean % change from baseline in MCS
TACIT <sup>141</sup>	Combination cDMARDs	AIC information has been removed	AiC information has been removed	AiC information has been removed	AiC information has been removed	AiC information has been removed	AiC information has been removed	AiC information has been removed	AiC information has been removed	NR
	TNF inhibitor + DMARD	AIC information has been removed	AiC information has been removed	AiC information has been removed	AiC information has been removed	AiC information has been removed	AiC information has been removed	AiC information has been removed	AiC information has been removed	NR

AIM, Abatacept in Inadequate responders to Methotrexate; MCS, mental component score; NR, not reported; PCS, physical component score.  
 ABT i.v. = BT ≈ 10 mg/kg intravenously on weeks 0, 2 and 4, and every 4 weeks thereafter.  
 CTZ = s.c. CTZ 400 mg at weeks 1, 2 and 4, then 200 mg every other week.  
 ETN = ETN 25 mg twice a week subcutaneously.  
 GOL = GOL 50 mg every 4 weeks subcutaneously.  
 IFX = IFX 3 mg/kg intravenously at weeks 0, 2, 6 and every 8 weeks thereafter (with dose escalation permitted after week 12 if lack of response).  
 TCZ = TCZ 8 mg/kg intravenously every 4 weeks.

a Estimated from graphical data.  
 b  $p < 0.001$ .  
 c  $p < 0.05$ .

**TABLE 383** The 0–100 SF-36 domains scores: baseline and follow-up – populations 2 and 3 RCTs of biologic vs. DMARD(s) or PBO

Trial name/ study	Treatment arms for which data extraction performed	Assessment point	Mean (SD) PF score at baseline	Mean (SD) PF score at follow-up	Mean (SD) RP score at baseline	Mean (SD) RP score at follow-up	Mean (SD) BP score at baseline	Mean (SD) BP score at follow-up
Durez <i>et al.</i> , 2004 <sup>36</sup>	MP + MTX	14 weeks	27 (26)	24 (26)	13 (28)	35 (41)	26 (16)	32 (24)
	IFX + MTX	14 weeks	36 (22)	55 (23) <sup>a</sup>	42 (48)	45 (42)	35 (23)	52 (16)
TACIT <sup>141</sup>	Combination cDMARDs	AiC information has been removed	AiC information has been removed	AiC information has been removed	AiC information has been removed	AiC information has been removed	AiC information has been removed	AiC information has been removed
	TNF inhibitor + DMARD	AiC information has been removed	AiC information has been removed	AiC information has been removed	AiC information has been removed	AiC information has been removed	AiC information has been removed	AiC information has been removed

BP, bodily pain; GH, general health; MH, mental health; PF, physical functioning; RE, role–emotional; RP, role–physical; SF, social functioning; VT, vitality.

IFX = IFX 3 mg/kg intravenously at weeks 0, 2, 6 and every 8 weeks thereafter (with dose escalation permitted after week 12 if lack of response).

a  $p < 0.05$ .

Mean (SD) GH score at baseline	Mean (SD) GH score at follow-up	Mean (SD) VT score at baseline	Mean (SD) VT score at follow-up	Mean (SD) SF score at baseline	Mean (SD) SF score at follow-up	Mean (SD) RE score at baseline	Mean (SD) RE score at follow-up	Mean (SD) MH score at baseline	Mean (SD) MH score at follow-up
26 (19)	29 (22)	27 (20)	29 (22)	44 (16)	40 (25)	22 (39)	39 (47)	45 (21)	45 (22)
40 (16)	50 (16) <sup>a</sup>	31 (25)	45 (20)	53 (30)	66 (22) <sup>a</sup>	58 (47)	67 (42)	52 (25)	60 (23)
AiC information has been removed	AiC information has been removed	AiC information has been removed	AiC information has been removed	AiC information has been removed	AiC information has been removed	AiC information has been removed	AiC information has been removed	AiC information has been removed	AiC information has been removed
AiC information has been removed	AiC information has been removed	AiC information has been removed	AiC information has been removed	AiC information has been removed	AiC information has been removed	AiC information has been removed	AiC information has been removed	AiC information has been removed	AiC information has been removed

**TABLE 384** The 0–100 SF-36 domains scores: mean change from baseline – populations 2 and 3 RCTs of biologic vs. DMARD(s) or PBO

Trial name	Treatment arms for which data extraction performed	Assessment point	Mean (SD) change from baseline in PF score	Mean (SD) change from baseline in RP score	Mean (SD) change from baseline in BP score	Mean (SD) change from baseline in GH score	Mean (SD) change from baseline in VT score	Mean (SD) change from baseline in SF score	Mean (SD) change from baseline in RE score	Mean (SD) change from baseline in MH score
CERTAIN <sup>79</sup>	PBO + cDMARDs	24 weeks	0.4 (8.90)	1.7 (7.81)	2.8 (8.50)	0.9 (8.06)	0.6 (8.41)	0.8 (8.89)	-0.2 (12.33)	1.2 (7.72)
ClinicalTrials.gov (NCT00674362)	CTZ + cDMARDs	24 weeks	5.1 (7.36)	4.7 (9.77)	8.0 (8.70)	5.0 (7.59)	6.4 (8.74)	4.3 (10.21)	3.2 (13.74)	5.2 (8.43)
TACIT <sup>141</sup>	Combination cDMARDs	AiC information has been removed	AiC information has been removed	AiC information has been removed	AiC information has been removed	AiC information has been removed	AiC information has been removed	AiC information has been removed	AiC information has been removed	AiC information has been removed
	TNF inhibitor + DMARD	AiC information has been removed	AiC information has been removed	AiC information has been removed	AiC information has been removed	AiC information has been removed	AiC information has been removed	AiC information has been removed	AiC information has been removed	AiC information has been removed

BP, bodily pain; GH, general health; MH, mental health; PF, physical functioning; RE, role–emotional; RP, role–physical; SF, social functioning; VT, vitality. CTZ = s.c. CTZ 400 mg at weeks 1, 2 and 4, then 200 mg every other week.

TABLE 385 The 0–100 EQ-5D: populations 2 and 3 RCTs of biologic vs. DMARD(s) or PBO

Trial name	Treatment arms for which data extraction performed	Assessment point	Mean EQ-5D score at baseline (0–1)	Mean (SD) EQ-5D score at follow-up (0–1)	Mean (SD) change from baseline in EQ-5D score (0–1)	Mean (SD) change from baseline in EQ-5D VAS (0–100)
ADORE <sup>59,60</sup>	ETN monotherapy	16 weeks	NR	NR	0.1883 (0.33)	19.76 (27.24)
	ETN + MTX	16 weeks	NR	NR	0.2399 (0.32)	21.00 (26.61)
TACIT <sup>141</sup>	Combination cDMARDs	AIC information has been removed	AIC information has been removed	AIC information has been removed	AIC information has been removed	AIC information has been removed
	TNF inhibitor + DMARD	AIC information has been removed	AIC information has been removed	AIC information has been removed	AIC information has been removed	AIC information has been removed

NR, not reported.  
ETN = ETN 25 mg twice a week subcutaneously.

**TABLE 386** The 0–100 EQ-5D domains scores: mean change from baseline – populations 2 and 3 RCTs of biologic vs. DMARD(s) or PBO

Trial name	Treatment arms for which data extraction performed	Assessment point	Mean (SD) change from baseline in usual activities (0–1)	Mean (SD) change from baseline in self-care (0–1)	Mean (SD) change from baseline in pain/discomfort (0–1)	Mean (SD) change from baseline in mobility (0–1)	Mean (SD) change from baseline in anxiety/depression (0–1)
ADORE <sup>59</sup>	ETN monotherapy	16 weeks	0.3077 (0.61)	0.1731 (0.55)	0.3718 (0.62)	0.3077 (0.50)	0.2323 (0.59)
	ETN + MTX	16 weeks	0.2867 (0.55)	0.3533 (0.55) <sup>a</sup>	0.4400 (0.65)	0.2318 (0.52)	0.24 (0.65)

ETN = ETN 25 mg twice a week subcutaneously.

GOL = GOL 50 mg every 4 weeks subcutaneously.

<sup>a</sup>  $p < 0.05$ .

Data are shown to the level of accuracy available in the source material.

**TABLE 387** The 0–100 EuroQol VAS scores: populations 2 and 3 RCTs of biologic vs. DMARD(s) or PBO

Trial name	Treatment arms for which data extraction performed	Assessment point	Mean (SD) baseline score	Mean % change
ETN study 309 <sup>89</sup>	SSZ + PBO	24 weeks	44.6 (19.0)	20.1
	ETN + PBO	24 weeks	45.5 (21.3)	64.6 <sup>a</sup> (vs. SSZ)
	ETN + SSZ	24 weeks	43.1 (22.4)	67.6 <sup>a</sup> (vs. SSZ)

ETN = ETN 25 mg twice a week subcutaneously.

<sup>a</sup>  $p < 0.05$ .

TABLE 388 Adverse events and discontinuations due to AEs: population 1 RCTs of biologic interventions vs. DMARD(s) or PBO

Trial name/ author, year	Treatment arms for which data extraction performed	RCT/LTE phase	Assessment time point	Discontinuation due to AE(s), n/N (%)	Number of patients experiencing one or more AE, n/N (%)	Number of patients experiencing one or more serious AE, n/N (%)
GUEPARD <sup>93</sup>	Initial MTX 12 weeks; then step-up therapy in both groups based on DAS28	RCT	52 weeks	NR	NR	5/32 (16)
						Five patients were hospitalised for the following reasons: one for vasculitis with revision of diagnosis to Sharp syndrome (week 6), one for hepatitis secondary to MTX (week 4), one for a hip prosthesis operation (week 12), one for weight loss (week 36) and one for haemophysis (week 32)
	Initial ADA + MTX 12 weeks; then step-up therapy in both groups based on DAS28	RCT	52 weeks	NR	NR	5/33 (15)
						One had hepatitis (week 6), the other had MTX pneumonia (week 6) and the last had acoustic neuroma (week 10) plus two malignancy
HIT HARD <sup>94</sup>	PBO + MTX	RCT	24 weeks	4/85 (4.7)	NR	NR
	ADA + MTX	RCT	24 weeks	2/87 (2.3)	NR	NR
HIT HARD <sup>94</sup>	PBO + MTX for 24 weeks followed by MTX for 24 weeks	LTE	48 weeks	7/85 (8.2)	NR	22/85 (25.9)
						Four serious infections (two urosepsis, one pneumonia), one stroke, one diplopia, one paraesthesia, three cardiac disorders (one bypass surgery, one claudication, one myocarditis), one reactive depression, three solid malignant tumours (one prostate, two cervix), one peripheral artery angioplasty, one shoulder impingement syndrome, one prolapsed lumbar disc, one fracture, three arthritis flare, one nephrolithiasis
	ADA + MTX for 24 weeks followed by OL MTX for 24 weeks	LTE	48 weeks	4/87 (4.6)	NR	12/87 (13.8)
						Three serious infections (one bronchitis, two abscess), one concussion, one syncope, one benign neoplasm (prostate), one subileus, one gastric haemorrhage, one varicose veins, one vasculitis, one coxarthrosis, one fracture

continued

TABLE 388 Adverse events and discontinuations due to AEs: population 1 RCTs of biologic interventions vs. DMARD(s) or PBO (continued)

Trial name/ author, year	Treatment arms for which data extraction performed	RCT/LTE phase	Assessment time point	Discontinuation due to AE(s), n/N (%)	Number of patients experiencing one or more AE, n/N (%)	Number of patients experiencing one or more serious AE, n/N (%)
OPERA <sup>107</sup>	PBO + MTX + steroid	RCT	12 months	1/91 (1.1)	NR	10/91 (11.0)
						Two malignancies (one urothelial carcinoma, one basocellular carcinoma), three serious infections (one pneumonia, one bronchitis, one dental abscess), two fivefold increased serum alanine aminotransferase, one disease exacerbation, one leucopenia, one polyneuropathia, one peptic ulcer, one coronary bypass, one hip fracture, one coxarthrosis
	ADA + MTX + steroid	RCT	12 months	2/89 (2.2)	NR	One patient who terminated due to non-compliance at 6 months died due to pneumonia 4 months later 14/89 (15.7)
						Three malignancies (one small cell lung carcinoma, one myelodysplastic syndrome, one basocellular carcinoma), three serious infections (one empyema, one pneumonia, one bronchitis), one suspected but unconfirmed infectious arthritis, one local s.c. atrophy, one blurred vision, one acute myocardial infarction, one tachicardia, one gonarthrosis
OPTIMA <sup>108</sup>	PBO + MTX	RCT	26 weeks	16/517 (3)	NR	NR
						Six serious infections
	ADA + MTX	RCT	26 weeks	21/515 (4)	NR	NR
						Two malignancies (one malignant melanoma in situ, one squamous cell carcinoma), 13 serious infections, one case of lupus-like syndrome, no lymphoma or demyelinating disease



Trial name/ author, year	Treatment arms for which data extraction performed	RCT/LTE phase	Assessment time point	Discontinuation due to AE(s), n/N (%)	Number of patients experiencing one or more AE, n/N (%)	Number of patients experiencing one or more serious AE, n/N (%)
PREMIER <sup>109</sup>	PBO + MTX	RCT	2 years	19/257 (7.4)	245/257 (95.3)	Seven serious infections (two pneumonia, one septic arthritis, one sinusitis, one abscess, one bacteraemia, one parotitis), four malignancies (lymphoma, melanoma, prostate, breast)
	ADA monotherapy + PBO	RCT	2 years	26/274 (9.5)	262/274 (95.6)	Three serious infections (one pneumonia, one cellulitis, one septic arthritis), one lupus-like reaction, four malignancies (breast, colon, multiple myeloma, metastatic cancer with unknown primary site)
	ADA + MTX	RCT	2 years	32/268 (11.9)	262/268 (97.8)	Nine serious infections [three pulmonary infections (including one plaural tuberculosis)], one sinus infection, one wound infection, one septic arthritis, one infected hygroma, one cellulitis, one urinary tract infection), two malignancies (one ovarian, one prostate)
PREMIER <sup>109</sup>	PBO + MTX to OL ADA monotherapy	LTE	5 years	7.7%	NR	2/497 (0.4)
	ADA monotherapy + PBO to OL ADA monotherapy	LTE	5 years	10.7%	NR	During open-label period: 3.3 serious infections per 100 person-years
	ADA + MTX to OL ADA monotherapy	LTE	5 years	14.2%	NR	Two TB, one lymphoma, one non-melanoma skin cancer, three breast cancer, two bladder cancer, one malignant melanoma, one tongue neoplasm, one pancreatic neoplasm, one lung cancer, one gastric cancer, one colon cancer. No lupus-like syndrome or demyelinating disease

continued

TABLE 388 Adverse events and discontinuations due to AEs: population 1 RCTs of biologic interventions vs. DMARD(s) or PBO (continued)

Trial name/ author, year	Treatment arms for which data extraction performed	RCT/LTE phase	Assessment time point	Discontinuation due to AE(s), n/N (%)	Number of patients experiencing one or more AE, n/N (%)	Number of patients experiencing one or more serious AE, n/N (%)
COMET <sup>81-83</sup>	PBO + MTX	RCT period 1, 52 weeks	52 weeks	34/268 (12.7)	246/268 (91.8)	34/268 (12.7)
						% NR if less than 1%
						Cardiac, two
						Eye, one
						Gastrointestinal, four
						General and administration site, one
						Infection, eight (3%)
						Injury, poisoning, and procedural complications, four
						Laboratory values, one
						Musculoskeletal and connective tissue, nine (3%)
						Nervous system, one
						Psychiatric, one
						Renal and urinary, one
						Respiratory, thoracic and mediastinal, one
						Surgical and medical procedures, two
						Vascular, two
						Malignancy, four

Trial name/ author, year	Treatment arms for which data extraction performed	RCT/LTE phase	Assessment time point	Discontinuation due to AE(s), n/N (%)	Number of patients experiencing one or more AE, n/N (%)	Number of patients experiencing one or more serious AE, n/N (%)
	ETN + MTX	RCT period 1, 52 weeks	52 weeks	28/274 (10.2)	247/274 (90.2)	33/274 (12.0)
						Cardiac, two
						Ear and labyrinth, one
						Gastrointestinal, one
						General and administration site, two
						Hepatobiliary, three
						Infection, five (2%)
						Injury, poisoning and procedural complications, three
						Laboratory values, one
						Metabolic and nutritional, two
						Musculoskeletal and connective tissue, four
						Nervous system, four
						Psychiatric, one
						Renal and urinary, one
						Respiratory, thoracic and mediastinal, three
						Skin and s.c. tissue, one
						Surgical and medical procedures, one
						Vascular, one
						Malignancy, four

continued

TABLE 388 Adverse events and discontinuations due to AEs: population 1 RCTs of biologic interventions vs. DMARD(s) or PBO (continued)

Trial name/ author, year	Treatment arms for which data extraction performed	RCT/LTE phase	Assessment time point	Discontinuation due to AE(s), n/N (%)	Number of patients experiencing one or more AE, n/N (%)	Number of patients experiencing one or more serious AE, n/N (%)
COMET/Emery 2010 <sup>82</sup>	MTX in year 1, MTX in year 2	RCT period 2	Weeks 52–104	NR	79/99 (79.8)	12/99 (12.1)  One death  Three malignancies
	MTX, year 1, ETN + MTX in year 2	RCT period 2	Weeks 52–104	NR	71/90 (78.9)	Remainder serious infections  11/90 (12.2)  Five malignancies
	ETN + MTX in year 1, ETN + MTX in year 2	RCT period 2	Weeks 52–104	NR	91/111 (82.0)	Remainder serious infections  8/111 (7.2)
	ETN + MTX in year 1, ETN in year 2	RCT period 2	Weeks 52–104	NR	89/111 (80.2)	Serious infections  10/111 (9.0)  One malignancy
ERA <sup>139</sup>	PBO + MTX	RCT	12 months	22/217 (10)	NR	Rest serious infections  NR  Two malignancies (bladder cancer, colon cancer)
	ETN + PBO	RCT	12 months	10/207 (5)	NR	Infections requiring hospitalisation/i.v. antibiotics in < 3%  NR  Three malignancies (carcinoid lung cancer, Hodgkin's disease and prostate cancer)
						Infections requiring hospitalisation/i.v. antibiotics in < 3%

Trial name/ author, year	Treatment arms for which data extraction performed	RCT/LTE phase	Assessment time point	Discontinuation due to AE(s), n/N (%)	Number of patients experiencing one or more AE, n/N (%)	Number of patients experiencing one or more serious AE, n/N (%)
ERA <sup>139</sup>	PBO + MTX	LTE	2 years	27/217 (12)	NR	NR
						Nine patients had infections requiring hospitalisation/i.v. antibiotics
	ETN + PBO	LTE	2 years	15/207 (7.2)	NR	Three malignancies
						NR
						Seven patients had infections requiring hospitalisation/i.v. antibiotics
						Four malignancies
GO-BEFORE <sup>90</sup>	PBO + MTX	RCT	24 weeks	2/160 (1.3)	116/160 (72.5)	11/160 (6.9) (NR for extracted treatment arm)
	GOL + MTX	RCT	24 weeks	6/158 (3.8)	129/158 (81.6)	10/185 (5.4) (NR for extracted treatment arm)
GO-BEFORE <sup>143</sup>	PBO + MTX	LTE	Week 104	NR	NR	N/A
	GOL + MTX	LTE	Week 104	NR	NR	13.7% (NR)
ASPIRE <sup>71</sup>	PBO + MTX	RCT	54 weeks	9/298 (3.0)	NR	2/291 (0.7) (myocardial infarction)
	IFX + MTX	RCT	54 weeks	34/373 (9.1)	NR	16/372 (4.3) (pneumonia, myocardial infarction, asthma, three TB, two infusion reactions)
Durez <i>et al.</i> , 2007 <sup>120</sup>	MTX	RCT	52 weeks	0/14	0/14	0/14
	MP + MTX	RCT	52 weeks	0/15	0/15	0/15
	IFX + MTX	RCT	52 weeks	1/15 (6.7)	1/15 (6.7)	1/15 (6.7)
						One case of MTX-related pneumonitis

continued

TABLE 388 Adverse events and discontinuations due to AEs: population 1 RCTs of biologic interventions vs. DMARD(s) or PBO (continued)

Trial name/ author, year	Treatment arms for which data extraction performed	RCT/LTE phase	Assessment time point	Discontinuation due to AE(s), n/N (%)	Number of patients experiencing one or more AE, n/N (%)	Number of patients experiencing one or more serious AE, n/N (%)
Quinn <i>et al.</i> , 2005 <sup>110</sup>	PBO + MTX IFX + MTX	LTE LTE	104 weeks 104 weeks	0/10 1/10 (10)	NR NR	NR NR

One cutaneous vasculitis (after single injection;  
withdrawn)

ASPIRE, Active controlled Study of Patients receiving Infliximab for the treatment of Rheumatoid arthritis of Early onset; ERA, Early Rheumatoid Arthritis (etanercept); HIT HARD, High Induction Therapy with Anti-Rheumatic Drugs (adalimumab and methotrexate); N/A, not applicable; NR, not reported; OL, open label; OPTIMA, OPTimal protocol for treatment Initiation with Methotrexate and Adalimumab; TB, tuberculosis.  
ADA = ADA 40 mg every other week subcutaneously.  
ETN = ETN 25 mg twice a week subcutaneously.  
IFX = IFX 3 mg/kg intravenously at weeks 0, 2, 6 and every 8 weeks thereafter (with dose escalation permitted after week 12 if lack of response).

TABLE 389 Adverse events and discontinuations due to AEs: populations 2 and 3 head-to-head biologic RCTs

Trial name/ study	Treatment arms for which data extraction performed	RCT/LTE phase	Assessment time point	Discontinuation due to AE(s), n/N (%)	Number of patients experiencing one or more AE, n/N (%)	Number of patients experiencing one or more serious AE, n/N (%)
ATTEST <sup>74</sup>	PBO + MTX	RCT	Day 197	1/110 (0.9)	92/110 (83.6)	13/110 (11.8) (type NR)
	IFX + MTX	RCT	Day 197	8/165 (4.8)	140/165 (84.8)	19/165 (11.5) (type NR)
	ABT + MTX	RCT	Day 197	2/156 (1.3)	129/156 (82.7)	8/156 (5.1) (type NR)
ATTEST <sup>74</sup>	(1) PBO + MTX	RCT	Day 365	–	–	–
	(2) IFX + MTX	RCT	Day 365	12/165 (7.3)	154/165 (93.3)	30/165 (18.2) (type NR)
	(3) ABT + MTX	RCT	Day 365	5/156 (3.2)	139/156 (89.1)	15/156 (9.6) (type NR)
AMPLE <sup>66</sup>	ABT s.c.	RCT	1 year	11/318 (3.5)	280/318 (88.1)	32/318 (10.1)
	ADA	RCT	1 year	20/328 (6.1)	283/328 (86.3)	30/328 (9.1)
						Seven serious infections (three pneumonia, two urinary tract infection, one gastroenteritis, one helicobacter gastritis), five malignancies (two squamous cell carcinoma of skin, one lymphoma, one prostate cancer, one squamous cell carcinoma of lung), one psoriasis, one erythema nodosum, one leukocytoclastic vasculitis, two Raynaud's phenomenon, one cutaneous lymphocytic vasculitis, one episcleritis, one Sjögren's syndrome
						Nine serious infections (two pneumonia, three bacterial arthritis, one chest wall abscess, one diverticulitis, one meningitis, one staphylococcal bursitis), four malignancies (two basal cell carcinoma, one small cell lung cancer, one transitional cell carcinoma), one psoriasis, one erythema nodosum, one Raynaud's phenomenon, one antiodouble-stranded DNA seropositivity

continued

TABLE 389 Adverse events and discontinuations due to AEs: populations 2 and 3 head-to-head biologic RCTs (continued)

Trial name/ study	Treatment arms for which data extraction performed	RCT/LTE phase	Assessment time point	Discontinuation due to AE(s), n/N (%)	Number of patients experiencing one or more AE, n/N (%)	Number of patients experiencing one or more serious AE, n/N (%)
RED-SEA <sup>14</sup>	ADA + cDMARDs	RCT	12 months	10/60 (16.7)	NR	6/60 (10)
						There were two deaths, both occurring in patients allocated ADA and resulting from ischaemic heart disease, one occurred a week after drug withdrawal
						Other events possibly related to therapy were acute cholecystitis (ADA)
	ETN50 + cDMARDs	RCT	12 months	12/60 (20)	NR	7/60 (11.7)
						One ovarian cancer
						One diagnosed with heart failure 2 weeks after drug withdrawal: an event believed to be possibly related to the treatment events possibly related to therapy
						A patient hospitalised with chest symptoms
						One acute myeloid leukaemia, group not specified
						Other serious AEs included hospitalisation for a ruptured popliteal cyst; chest symptoms; syncope; suspected femoral fracture; angioedema and urticaria; stillbirth from pregnancy while on treatment and cellulitis



Trial name/ study	Treatment arms for which data extraction performed	RCT/LTE phase	Assessment time point	Discontinuation due to AE(s), n/N (%)	Number of patients experiencing one or more AE, n/N (%)	Number of patients experiencing one or more serious AE, n/N (%)
ADACTA <sup>58</sup>	TCZ + s.c. PBO	RCT	24 weeks	9/163 (5.5)	133/162 (82.1)	19/162 (11.7) (including infections, two myocardial infarction/acute coronary syndrome, one stroke, one cancer)
	ADA + i.v. PBO	RCT	24 weeks	10/163 (6.1)	134/162 (82.7)	16/162 (9.9) (including infections, two myocardial infarction/acute coronary syndrome, one stroke, one cancer, one hypersensitivity reaction)

DNA, deoxyribonucleic acid; ETN50, etanercept 50 mg once a week subcutaneously, NR, not reported.  
 ABT i.v. = BT ≈ 10 mg/kg intravenously on weeks 0, 2 and 4, and every 4 weeks thereafter.  
 ABT s.c. = ABT 125 mg once per week subcutaneously, following an optional i.v. loading dose of ≈ 10 mg/kg based on weight range.  
 ADA = ADA 40 mg every other week subcutaneously.  
 IFX = IFX 3 mg/kg intravenously at weeks 0, 2, 6 and every 8 weeks thereafter (with dose escalation permitted after week 12 if lack of response).  
 TCZ = TCZ 8 mg/kg intravenously every 4 weeks.

TABLE 390 Adverse events and discontinuations due to AEs: populations 2 and 3 RCTs of biologic interventions vs. DMARD(s) or PBO

Trial name/ author, year	Treatment arms for which data extraction performed	RCT/LTE phase	Assessment time point	Discontinuation due to AE(s), n/N (%)	Number of patients experiencing one or more AE, n/N (%)	Number of patients experiencing one or more serious AE, n/N (%)
AIM <sup>61,62</sup>	PBO + MTX	RCT	12 months	1.8	184/219 (84.0)	26/219 (11.9)
						Related to study drug, one (0.5%)
						Discontinuations due to serious AEs, three (1.4%)
						Musculoskeletal and connective tissue disorders, 10 (4.6%)
						Infections, five (2.3%)
						Nervous system disorders, four (1.8%)
						Cardiac disorders), two (0.9%)
						Neoplasms (benign, malignant and unspecified), two (0.9%)
	ABT i.v. + MTX	RCT	12 months	4.2	378/433 (87.3)	65/433 (15.0)
						Related to study drug, 15 (3.5%)
						Discontinuations due to serious AEs, 10 (2.3%)
						Musculoskeletal and connective tissue disorders, 20 (4.6%)
						Infections, 17 (3.9%)
						Nervous system disorders, six (1.4%)
						Cardiac disorders, four (0.9%)
						Neoplasms (benign, malignant and unspecified), four (0.9%)

Trial name/ author, year	Treatment arms for which data extraction performed	RCT/LTE phase	Assessment time point	Discontinuation due to AE(s), n/N (%)	Number of patients experiencing one or more AE, n/N (%)	Number of patients experiencing one or more serious AE, n/N (%)
AIM <sup>64</sup>	ABT i.v. + MTX 2 years or MTX + PBO 1 year then ABT i.v. + MTX 1 year	LTE	2 years	38/593 (6.4)	550/593 (92.7)	149/593 (25.1) <i>Excluding worsening of arthritis, the most frequent serious AEs were osteoarthritis, pneumonia, basal cell carcinoma and chest pain, all of which occurred in &gt; 0.5% of patients during the cumulative study period</i>
AIM <sup>65</sup>	ABT i.v. + MTX 2 years or MTX + PBO 1 year then ABT i.v. + MTX 1 year	LTE	3 years	55/593	569/593 (96)	NR
ASSET <sup>72</sup>	PBO + MTX	RCT	4 months	0/23	14/23 (60.9)	2/23 (8.7)
ASSET <sup>72</sup>	ABT i.v. + MTX	RCT	4 months	0/27	20/27 (74.1)	One atrial fibrillation, one study drug overdose
	ABT i.v. + MTX	LTE	1 year	0/49	41/49 (83.7)	0/27 6/49 (12.2)
AUGUST II <sup>76</sup>	PBO + MTX	38-week follow-up of 26-week RCT treatment	38 weeks	2/76 (2.6)	38/76 (50)	NR
	ADA + MTX	38-week follow-up of 26-week RCT treatment	38 weeks	2/79 (2.5)	50/79 (63)	NR

continued

TABLE 390 Adverse events and discontinuations due to AEs: populations 2 and 3 RCTs of biologic interventions vs. DMARD(s) or PBO (continued)

Trial name/ author, year	Treatment arms for which data extraction performed	RCT/LTE phase	Assessment time point	Discontinuation due to AE(s), n/N (%)	Number of patients experiencing one or more AE, n/N (%)	Number of patients experiencing one or more serious AE, n/N (%)
CHANGE <sup>80</sup>	PBO	RCT	24 weeks	4/87 (4.6)	71/87 (81.6)	8/87 (9.2)
	ADA monotherapy	RCT	24 weeks	12/91 (13.2)	90/91 (98.9)	17/91 (18.7)
DE019 <sup>84</sup>	PBO + MTX	RCT	52 weeks	NR	181/200 (90.5)	NR One death Others not specified
	ADA + MTX	RCT	52 weeks	NR	NR	NR Two malignancies Others not specified
ASSURE <sup>73</sup>	PBO + cDMARDs	RCT	1 year	18/418 (4.3)	360/418 (86.1)	51/418 (12.2)
	ABT + cDMARDs	RCT	1 year	43/856 (5.0)	768/856 (89.7)	100/856 (11.7)

Seven serious infections, 16 neoplasms and the following serious infections: four respiratory, one dermatological, one urinary, one gastrointestinal, one gynaecologic, two opportunistic

22 serious infections, 27 neoplasms and the following serious infections: nine respiratory, five dermatological, four urinary, two gastrointestinal

Trial name/ author, year	Treatment arms for which data extraction performed	RCT/LTE phase	Assessment time point	Discontinuation due to AE(s), n/N (%)	Number of patients experiencing one or more AE, n/N (%)	Number of patients experiencing one or more serious AE, n/N (%)
STAR <sup>117</sup>	PBO + cDMARDs	RCT	24 weeks	8/318 (2.5)	263/318 (82.7)	22/318 (6.9)
				(Of which one considered non-treatment related)		Six serious infections Others not specified
	ADA + cDMARDs (n = 318)	RCT	24 weeks	9/318 (2.8)	275/318 (86.5)	Severe or life-threatening AEs, 49/318 (15.4) 17/318 (5.3)
						Four serious infections One death One malignancy Others not specified
Van De Putte et al., 2004 <sup>122</sup>	PBO s.c.	RCT	26 weeks	1/110 (0.9)	105/110 (95.5)	Severe or life-threatening AEs, 38/318 (11.9) 16/110 (14.5)
	ADA monotherapy	RCT	26 weeks	6/113 (5.3)	NR	13/113 (11.5)
ARMADA <sup>69,70</sup>	PBO + MTX	RCT	24 weeks	2/62 (3.2)	NR	NR
	ADA + MTX	RCT	24 weeks	0/67 (0)	NR	NR

continued

TABLE 390 Adverse events and discontinuations due to AEs: populations 2 and 3 RCTs of biologic interventions vs. DMARD(s) or PBO (continued)

Trial name/ author, year	Treatment arms for which data extraction performed	RCT/LTE phase	Assessment time point	Discontinuation due to AE(s), n/N (%)	Number of patients experiencing one or more AE, n/N (%)	Number of patients experiencing one or more serious AE, n/N (%)
Kim <i>et al.</i> , 2007 <sup>99</sup>	PBO + MTX	RCT	24 weeks	NR	82.5%	6/63 (9.5)
	ADA + MTX	RCT	24 weeks	NR	(Possibly related to study drug 28.6%) 84.6%	NR 7/65 (10.8)
					(Possibly related to study drug 26.2%)	The number of serious AEs reported was comparable between the ADA group and the PBO group. Three of the seven serious AEs reported in the ADA group were of infectious aetiology (two pneumonia and one disseminated tuberculosis), one was a complication due to the serious AE of pneumonia (acute respiratory distress syndrome), and the other was vasovagal attack
CERTAIN <sup>79</sup>	PBO + cDMARDs	RCT	24 weeks	NR	NR (67.3)	NR (7.1)
	CTZ + DMARDs	RCT	24 weeks	NR	NR (68.8)	NR (5.2)
						One death in the ADA treatment group Serious infections in 1.0% Serious infections in 5.2%

Trial name/ author, year	Treatment arms for which data extraction performed	RCT/LTE phase	Assessment time point	Discontinuation due to AE(s), n/N (%)	Number of patients experiencing one or more AE, n/N (%)	Number of patients experiencing one or more serious AE, n/N (%)
ADORE <sup>59,60</sup>	ETN monotherapy	RCT	16 weeks	13/159 (8.2)	100/159 (62.9)	8/159 (5.0)
ADORE <sup>59</sup>	ETN + MTX	RCT	16 weeks	9/155 (5.8)	109/155 (70.3)	7/155 (4.5)
CREATE IIb <sup>96</sup>	DMARD + PBO (n = 65)	RCT	24 weeks	9.2%	NR	NR
	ETN50 + DMARD (n = 64)	RCT	24 weeks	3.1%	NR	NR
ETN study 309 <sup>89</sup>	SSZ + PBO	RCT	24 weeks	Due to serious AE, 1/50	NR	NR
					Non-infectious AEs, 29/50 (58)	Non-infectious serious AEs, 1/50 (2)
	ETN + PBO	RCT	24 weeks	Due to serious AE, 1/103	NR	NR
					Non-infectious AEs, 74/103 (71.8)	Non-infectious serious AEs, 3/103 (2.9)
	ETN + SSZ	RCT	24 weeks	Due to serious AE, 1/101	NR	NR
					Non-infectious AEs, 72/101 (71.3)	Non-infectious serious AEs, 5/101 (5)

continued

TABLE 390 Adverse events and discontinuations due to AEs: populations 2 and 3 RCTs of biologic interventions vs. DMARD(s) or PBO (continued)

Trial name/ author, year	Treatment arms for which data extraction performed	RCT/LTE phase	Assessment time point	Discontinuation due to AE(s), n/N (%)	Number of patients experiencing one or more AE, n/N (%)	Number of patients experiencing one or more serious AE, n/N (%)
ETN study 309 <sup>89</sup>	SSZ + PBO	RCT	2 years	NR	NR	2/50 (4)
					Non-infectious AEs 32/50 (64)	
					Infectious AEs 21/50 (42.0)	
					32	
	ETN + PBO	RCT	2 years	NR	NR	27/103 (26.2)
					Non-infectious AEs 90/103 (87.4)	
					Infectious AEs 76/103 (73.8)	
	ETN + SSZ	RCT	2 years	NR	NR	23/101 (22.8)
					Non-infectious AEs 80/101 (79.2)	
					Infectious AEs 60/101 (59.4)	
JESMR <sup>140</sup>	ETN monotherapy	RCT	52 weeks	4/71 (5.6)	NR	2/71 (2.8)
						Two bone fractures
	ETN + MTX	RCT	52 weeks	1/76 (13.1)	NR	7/76 (9.2)
						Three bone fractures, one congestive heart failure, one cellulitis (in same patient as one of the fractures), one herpes zoster, one brain, one mammary carcinoma



Trial name/ author, year	Treatment arms for which data extraction performed	RCT/LTE phase	Assessment time point	Discontinuation due to AE(s), n/N (%)	Number of patients experiencing one or more AE, n/N (%)	Number of patients experiencing one or more serious AE, n/N (%)
Lan <i>et al.</i> , 2004 <sup>101</sup>	PBO + MTX	RCT	12 weeks	1/29 (3.4)	NR	NR
	ETN + MTX	RCT	12 weeks	1/29 (3.4)	NR	One bronchiolitis obliterans
					Most frequently occurring AEs in line with summary of product characteristics	NR
LARA <sup>102</sup>	MTX + DMARD	RCT	24 weeks	NR	97/142 (68.3)	2/142 (1.4)
	ETN50 + MTX	RCT	24 weeks	NR	193/281 (68.7)	Specific AEs NR 10/281 (3.6)
						Specific AEs NR

continued

TABLE 390 Adverse events and discontinuations due to AEs: populations 2 and 3 RCTs of biologic interventions vs. DMARD(s) or PBO (continued)

Trial name/ author, year	Treatment arms for which data extraction performed	RCT/LTE phase	Assessment time point	Discontinuation due to AE(s), n/N (%)	Number of patients experiencing one or more AE, n/N (%)	Number of patients experiencing one or more serious AE, n/N (%)
RACAT <sup>111</sup>	MTX + SSZ + HCQ  On treatment analysis, n = 222 (some patients exposed to both treatments throughout trial)	RCT including crossover	48 weeks	12/222 (5.4)	170/222 (76.6)	25/222 (11.3) (some patients counted in more than one event)  Cardiac disorders, four  Gastrointestinal disorders, five  Infections and infestations, four  Renal and urinary disorders, one  Respiratory, thoracic and mediastinal disorders, four  Surgical and medical procedures, three  Vascular disorders, three
	ETN50 + MTX  On treatment analysis, n = 219 (some patients exposed to both treatments throughout trial)	RCT including crossover	48 weeks	5/219 (2.3)	165/219 (75.3)	Other (events occurring fewer than three times), nine  26/219 (11.9) (some patients counted in more than one event)  Cardiac disorders, one  Gastrointestinal disorders, four  Infections and infestations, 12  Renal and urinary disorders, three  Respiratory, thoracic and mediastinal disorders, one  Surgical and medical procedures, five  Vascular disorders, four  Other (events occurring fewer than three times), nine

Trial name/ author, year	Treatment arms for which data extraction performed	RCT/LTE phase	Assessment time point	Discontinuation due to AE(s), n/N (%)	Number of patients experiencing one or more AE, n/N (%)	Number of patients experiencing one or more serious AE, n/N (%)
Weinblatt <i>et al.</i> , 1999 <sup>124</sup>	PBO + MTX	RCT	24 weeks	1/30 (3.3)	NR	NR
	ETN + MTX	RCT	24 weeks	2/59 (3.4)	NR	NR
	MTX + DMARD (SSZ, HCQ or LEF)	RCT	16 weeks	8/103 (7.8)	79/103 (77)	3/103 (3)
APPEAL <sup>67,68</sup>	ETN + MTX	RCT	16 weeks	3/197 (1.5)	134/197 (68)	6/197 (3)
						One infection/infestation, two increased alanine aminotransferase
GO-FORTH <sup>91</sup>	PBO + MTX	RCT	24 weeks	NR	67/88 (76.1)	1/88 (1.1)
	GOL + MTX	RCT	24 weeks	NR	70/86 (81.4)	2/86 (2.3)
GO-FORWARD <sup>92</sup>	PBO + MTX	RCT	24 weeks	5/133 (3.8)	89/134 (66.4)	5/134 (3.7) (type NR)
	GOL + MTX	RCT	24 weeks	2/89 (2.2)	87/212 (41.0)	9/212 (4.2) (type NR)
GO-FORWARD <sup>92</sup>	PBO + MTX	RCT	52 weeks	8/133 (6.0)	98/133 (73.7)	6/133 (4.5) (type NR)
	GOL + MTX	RCT	52 weeks	7/212 (3.3)	167/212 (78.8)	17/212 (8.0) (type NR)
Kay <i>et al.</i> , 2008 <sup>98</sup>	IFX + MTX (PBO group crossed over to IFX at week 20)	RCT	52 weeks	3/25 (12.0)	16/25 (64.0)	3/25 (12.0) (type NR)
	GOL + MTX	RCT	52 weeks	4/37 (10.8)	34/37 (91.9)	7/37 (18.9) (type NR)
Abe <i>et al.</i> , 2006 <sup>56</sup>	PBO + MTX	RCT	14 weeks	1/47 (2.1)	NR	1/47 (2.1) (type NR for extracted arm)
	IFX + MTX	RCT	14 weeks	1/49 (2.0)	NR	0

continued

TABLE 390 Adverse events and discontinuations due to AEs: populations 2 and 3 RCTs of biologic interventions vs. DMARD(s) or PBO (continued)

Trial name/ author, year	Treatment arms for which data extraction performed	RCT/LTE phase	Assessment time point	Discontinuation due to AE(s), n/N (%)	Number of patients experiencing one or more AE, n/N (%)	Number of patients experiencing one or more serious AE, n/N (%)
Abe <i>et al.</i> , 2006 <sup>36</sup>	PBO group crossover to IFX	LTE	To week 36 of LTE	9/41 (22.0)	NR	6/41 (14.6) (type NR for extracted arm)
	IFX + MTX	LTE	To week 36 of LTE	4/49 (8.2)	NR	2/49 (4.1) (type NR for extracted arm)
ATTRACT <sup>146</sup>	PBO + MTX	RCT	54 weeks	7/88 (8.0)	94%	18/86 (20.9) (type NR)
	IFX + MTX	RCT	54 weeks	5/86 (5.8)	NR	10/88 (11.4) (type NR)
ATTRACT <sup>324</sup>	PBO + MTX	LTE	102 weeks	NR	NR	28/NR (33) (type NR)
	IFX + MTX	LTE	102 weeks	NR	NR	29/NR (33) (type NR)
START <sup>118</sup>	PBO + MTX	RCT	22 weeks	5/361 (1.4)	239/361 (66.2)	27/361 (7.5)
	IFX + MTX	RCT	22 weeks	0/360	251/360 (69.7)	One fever, one osteoarthritis, four RA 28/360 (7.8)
START <sup>118</sup>	IFX + MTX	LTE	54 weeks	NR	211/244 (86.5)	Two pneumonia, one cellulitis, one chest pain, two osteoarthritis, one cardiac failure, one myocardial infarction, two uterine fibroid, one RA 39/244 (16.0)
Swefo <sup>119</sup>	SSZ + HCQ + MTX	RCT	24 months	22/130 (16.9)	NR/130 (45)	Five pneumonia, one active TB, one abscess, two pyelonephritis Serious AEs = one (1) (generalised symptoms)
	IFX + MTX	RCT	24 months	19/128 (14.8)	NR/128 (38)	Serious AEs = two (2) (persistent fever and generalised symptoms)
Zhang <i>et al.</i> , 2006 <sup>726</sup>	PBO + MTX	RCT	18 weeks	4/86 (4.7)	48/86 (55.8)	NR
	IFX + MTX	RCT	18 weeks	6/87 (6.9)	57/87 (65.5)	NR
ACT-RAY <sup>152</sup>	TCZ + oral PBO	RCT	52 weeks	NR	228/276 (82.6)	26/276 (9.4)
	TCZ + MTX	RCT	52 weeks	NR	277/277 (100%) <sup>a</sup>	24/277 (8.7)

Trial name/ author, year	Treatment arms for which data extraction performed	RCT/LTE phase	Assessment time point	Discontinuation due to AE(s), n/N (%)	Number of patients experiencing one or more AE, n/N (%)	Number of patients experiencing one or more serious AE, n/N (%)
Nishimoto <i>et al.</i> , 2004 <sup>106</sup>	PBO i.v. TCZ	RCT RCT	12 weeks 12 weeks	4/53 (7.5) 2/55 (3.6)	NR/53 (56) NR/55 (51)	2/53 (3.8) (type NR) NR for TCZ 8 mg/kg
STREAM/ Nishimoto <i>et al.</i> , 2009 <sup>325</sup> (LTE of Nishimoto <i>et al.</i> , 2004 <sup>106</sup> )	PBO i.v. TCZ	LTE LTE	To year 5 To year 5	– 32/143 (22.4)	– NR	– 77/143 (53.8) [including joint surgery n = 20 (most common), pneumonia n = 9, herpes zoster n = 7, tendon rupture n = 5, humerus fracture n = 4, acute bronchitis n = 2]
SAMURAI <sup>115</sup>	CDMARDS	RCT	52 weeks	5/145 (3.4)	119/145 (82)	NR/145 (13) Only serious infections listed, not other serious AEs
	TCZ	RCT	52 weeks	17/157 (10.8)	140/157 (89)	NR/157 (18) Only serious infections listed, not other serious AEs
SATORI <sup>116</sup>	PBO i.v. + MTX TCZ + PBO capsules	RCT RCT	24 weeks 24 weeks	3/64 (4.7) 2/61 (3.3)	46/64 (71.9) (104 AEs) 56/61 (91.8) (211 AEs)	3/64 (4.7) (one pneumonia, one spinal compression fracture, one femoral neck fracture) 4/61 (6.6) (one pneumonia, one infectious arthritis, one colonic polyp, one headache)

continued

TABLE 390 Adverse events and discontinuations due to AEs: populations 2 and 3 RCTs of biologic interventions vs. DMARD(s) or PBO (continued)

Trial name/ author, year	Treatment arms for which data extraction performed	RCT/LTE phase	Assessment time point	Discontinuation due to AE(s), n/N (%)	Number of patients experiencing one or more AE, n/N (%)	Number of patients experiencing one or more serious AE, n/N (%)
TOWARD <sup>21</sup>	PBO + stable cDMARDs	RCT	24 weeks	8/414 (1.9)	253/414 (61.1)	18/414 (4.3)
	TCZ + stable DMARDs	RCT	24 weeks	31/802 (3.9)	584/802 (72.8)	[Related serious AE = 6 (1.4) type NR] 54/802 (6.7)
TACIT <sup>141</sup>	(1) Combination cDMARDs	AiC information has been removed	AiC information has been removed	AiC information has been removed	AiC information has been removed	AiC information has been removed
	(2) TNF inhibitor + DMARD	AiC information has been removed	AiC information has been removed	AiC information has been removed	AiC information has been removed	AiC information has been removed
TACIT <sup>141</sup>	(1) Combination cDMARDs	AiC information has been removed	AiC information has been removed	AiC information has been removed	AiC information has been removed	AiC information has been removed
	(2) TNF inhibitor + DMARD	AiC information has been removed	AiC information has been removed	AiC information has been removed	AiC information has been removed	AiC information has been removed

AIM, Abatacept in Inadequate responders to Methotrexate; ASSET, Abatacept Systemic Sclerosis Trial; CHANGE, Clinical investigation in Highly disease-affected rheumatoid Arthritis patients in Japan with Adalimumab applying standard and General Evaluation study; ETN50, etanercept 50 mg once a week subcutaneously; NR, not reported; SATORI, Study of Active controlled Tocilizumab for Rheumatoid arthritis patients with an Inadequate response to methotrexate; STAR, Safety Trial of Adalimumab in Rheumatoid arthritis.

ABT i.v. = BT ≈ 10 mg/kg intravenously on weeks 0, 2 and 4, and every 4 weeks thereafter.

ADA = ADA 40 mg every other week subcutaneously.

CTZ = s.c. CTZ 400 mg at weeks 1, 2 and 4, then 200 mg every other week.

ETN = ETN 25 mg twice a week subcutaneously.

GOL = GOL 50 mg every 4 weeks subcutaneously.

IFX = IFX 3 mg/kg intravenously at weeks 0, 2, 6 and every 8 weeks thereafter (with dose escalation permitted after week 12 if lack of response).

TCZ = TCZ 8 mg/kg intravenously every 4 weeks.

a Calculated by review authors.

TABLE 391 Specific categories of AEs: population 1 RCTs of biologic interventions vs. DMARD(s) or PBO

Trial name/ study	Treatment arms for which data extraction performed	RCT/LTE phase	Assessment time point	Number of patients experiencing one or more infection, n/N (%)	Number of patients experiencing one or more serious infection, n/N (%)	Number of patients experiencing any infection requiring antibiotics, n/N (%)	Number of patients experiencing one or more malignancy, n/N (%)	Number of patients experiencing injection-site reaction (s.c. administration), n/N (%)	Number of patients experiencing one or more infusion-related reaction (i.v. administration), n/N (%)
GUEPARD <sup>93</sup>	Initial MTX 12 weeks, then step-up therapy in both groups based on DAS28	RCT	52 weeks	NR	1/32 (3)	NR	0	NR	N/A
	Initial ADA + MTX 12 weeks, then step-up therapy in both groups based on DAS28	RCT	52 weeks	NR	2/33 (6)	NR	2/33 (6)	NR	N/A
HIT HARD <sup>94</sup>	MTX + PBO for 24 weeks followed by OL MTX for 24 weeks	LTE	48 weeks	10/85 (11.8)	4/85 (4.7)	NR	3/85 (3.5)	4/85 (4.7)	NR
	ADA + MTX for 24 weeks followed by OL MTX for 24 weeks	LTE	48 weeks	16/87 (18.4)	3/87 (3.4)	NR	0/87	14/87 (16.1)	NR
OPERA <sup>107</sup>	PBO + MTX + steroid	RCT	12 months	NR	3/91 (3.3)	NR	2/91 (2.2)	NR	NR
	ADA + MTX + steroid	RCT	12 months	NR	3/89 (3.4)	NR	3/89 (3.4)	NR	NR
PREMIER <sup>109</sup>	ADA (all patients who received ≥ 1 dose)	LTE	5 years	NR	NR; 3.3 events per 100 patient-years	NR	11/497 (2.2)	NR	NR
COMET <sup>81</sup>	PBO + MTX	RCT period 1, 52 weeks	52 weeks	8/268 (3.0)	NR	NR	4/268 (1.5)	NR	NR
	ETN + MTX	RCT period 1, 52 weeks	52 weeks	5/274 (1.8)	NR	NR	4/274 (1.5)	NR	NR
COMET <sup>82</sup>	MTX in year 1, MTX in year 2	RCT period 2	Weeks 52–104	NR	2/99 (2.0)	NR	3/99 (3.0)	NR	NR

continued

**TABLE 391** Specific categories of AEs: population 1 RCTs of biologic interventions vs. DMARD(s) or PBO (continued)

Trial name/ study	Treatment arms for which data extraction performed	RCT/LTE phase	Assessment time point	Number of patients experiencing one or more serious infection, n/N (%)	Number of patients experiencing one or more infection requiring antibiotics, n/N (%)	Number of patients experiencing one or more malignancy, n/N (%)	Number of patients experiencing one or more injection-site reaction (s.c. administration), n/N (%)	Number of patients experiencing one or more infusion-related reaction (i.v. administration), n/N (%)
COMET <sup>81</sup>	MTX in year 1, ETN + MTX in year 2	RCT period 2	Weeks 52–104	NR	1/90 (1.1)	NR	5/90 (5.6)	NR
COMET <sup>81</sup>	ETN + MTX in year 1, ETN + MTX in year 2	RCT period 2	Weeks 52–104	NR	1/111 (0.9)	NR	0 (0)	NR
COMET <sup>81</sup>	ETN + MTX in year 1, ETN in year 2	RCT period 2	Weeks 52–104	NR	2/111 (1.8)	NR	1/111 (0.9)	NR
ERA <sup>139</sup>	PBO + MTX	RCT	12 months	NR	NR	<3%	2/217 (0.9)	NR
ERA <sup>139</sup>	ETN + PBO	RCT	12 months	NR	NR	<3%	3/207 (1.4)	NR
ERA <sup>139</sup>	PBO + MTX	LTE	2 years	NR	9/217 (4.1)	NR	3/217 (1.4)	NR
ERA <sup>139</sup>	ETN + PBO	LTE	2 years	NR	7/207 (3.4)	NR	4/207 (1.9)	NR
GO-BEFORE <sup>90</sup>	PBO + MTX	RCT	24 weeks	52/160 (32.5)	3/160 (1.9)	NR	2/160 (1.3)	N/A
GO-BEFORE <sup>143</sup>	GOL + MTX	RCT	24 weeks	54/158 (34.2)	2/158 (1.3)	NR	1/158 (0.6)	N/A
GO-BEFORE <sup>143</sup>	PBO + MTX	LTE	Week 104	NR	NR	NR	Two (no n provided, assumed n = 160)	NR
GO-BEFORE <sup>143</sup>	GOL + MTX	LTE	Week 104	NR	5.5%	NR	Six (no n provided, assumed n = 158)	NR



Trial name/ study	Treatment arms for which data extraction performed	RCT/LTE phase	Assessment time point	Number of patients experiencing one or more infection, n/N (%)	Number of patients experiencing one or more serious infection, n/N (%)	Number of patients experiencing any infection requiring antibiotics, n/N (%)	Number of patients experiencing one or more malignancy, n/N (%)	Number of patients experiencing one or more injection-site reaction (s.c. administration), n/N (%)	Number of patients experiencing one or more infusion-related reaction (i.v. administration), n/N (%)
ASPIRE <sup>71</sup>	PBO i.v. + MTX	RCT	54 weeks	NR	21/372 (5.6)	NR	0	N/A	20/291 (6.9)
	IFX + MTX	RCT	54 weeks	NR	PBO i.v. + MTX = 6/291 (2.1)	NR	0	N/A	79/372 (21.2) (two classed as serious)
Durez <i>et al.</i> , 2007 <sup>120</sup>	MTX	RCT	52 weeks	14/14 (100)	0/14	NR	NR	NR	NR
	MTX + MP	RCT	52 weeks	12/15 (80)	0/15	NR	NR	NR	NR
	IFX + MTX	RCT	52 weeks	12/15 (80)	1/15 (6.7)	NR	NR	NR	NR
Quinn <i>et al.</i> , 2005 <sup>110</sup>	PBO + MTX	LTE	104 weeks	NR	NR	NR	NR	NR	0/10
	IFX + MTX	LTE	104 weeks	NR	NR	NR	NR	NR	1/10 (10)

ASPIRE, Active controlled Study of Patients receiving Infliximab for the treatment of Rheumatoid arthritis of Early onset; ERA, Early Rheumatoid Arthritis (etanercept); HIT HARD, High Induction Therapy with Anti-Rheumatic Drugs (adalimumab and methotrexate); N/A, not applicable; NR, not reported; OL, open label; TB, tuberculosis.  
 ADA = ADA 40 mg every other week subcutaneously.  
 ETN = ETN 25 mg twice a week subcutaneously.  
 GOL = GOL 50 mg every 4 weeks subcutaneously.  
 IFX = IFX 3 mg/kg intravenously at weeks 0, 2, 6 and every 8 weeks thereafter (with dose escalation permitted after week 12 if lack of response).  
 a  $p = 0.02$ .

TABLE 392 Specific categories of AEs: populations 2 and 3 head-to-head biologic RCTs

Trial name/ author, year	Treatment arms for which data extraction performed	RCT/LTE phase	Assessment time point	Number of patients experiencing infection, n/N (%)	Number of patients experiencing one or more serious infection, n/N (%)	Number of patients experiencing any infection requiring antibiotics, n/N (%)	Number of patients experiencing one or more infection-related reaction (i.v. administration), n/N (%)	Number of patients experiencing one or more injection-site reaction (s.c. administration), n/N (%)	Number of patients experiencing one or more infection-related reaction (i.v. administration), n/N (%)
ATTEST <sup>74</sup>	PBO + MTX	RCT	Day 197	NR	3/110 (2.7)	NR	1/110 (0.9)	N/A	10.0%
	IFX + MTX	RCT	Day 197	NR	7/165 (4.2)	NR	2/165 (1.2)	N/A	18.2%
	ABT + MTX	RCT	Day 197	NR	2/156 (1.3)	NR	1/156 (0.6)	N/A	5.1%
ATTEST <sup>74</sup>	PBO + MTX	RCT	Day 365	-	-	-	-	-	-
	IFX + MTX	RCT	Day 365	NR	14/165 (8.5)	NR	2/165 (1.2)	N/A	41/165 (24.8)
AMPLE <sup>66</sup>	ABT + MTX	RCT	Day 365	NR	3/156 (1.9)	NR	1/156 (0.6)	N/A	11/156 (7.1)
	ABT s.c.	RCT	2 years	63.2%	7/318 (2.2)	NR	5/318 (1.6)	12/318 (3.8)	N/A
	ADA	RCT	2 years	61.3%	9/328 (2.7)	NR	4/328 (1.2)	30/328 (9.1)	N/A
RED-SEA <sup>114</sup>	ADA + cDMARDs	RCT	12 months	NR	NR	NR	1/60 (1.7)	9/60 (15)	N/A
	ETN50 + cDMARDs	RCT	12 months	NR	NR	NR	1/60 (1.7)	19/60 (31.7)	N/A
ADACTA <sup>58</sup>	TCZ + s.c. PBO	RCT	24 weeks	77/162 (47.5)	5/162 (3.1)	NR	1/162	N/A	NR
	ADA + i.v. PBO	RCT	24 weeks	68/162 (42.0)	5/162 (3.1)	NR	1/162	NR	N/A

Trial name/ author, year	Treatment arms for which data extraction performed	RCT/LTE phase	Assessment time point	Number of patients experiencing one or more infection, n/N (%)	Number of patients experiencing one or more serious infection, n/N (%)	Number of patients experiencing any infection requiring antibiotics, n/N (%)	Number of patients experiencing one or more malignancy, n/N (%)	Number of patients experiencing one or more injection-site reaction (s.c. administration), n/N (%)	Number of patients experiencing one or more infection-related reaction (i.v. administration), n/N (%)
ADACTA <sup>58</sup>	TCZ	LTE	To year 5	NR	25/143 (17.5) (pneumonia, herpes zoster, acute bronchitis, pyelonephritis)	NR	4/143 (2.8) (bladder cancer, breast cancer, large intestine carcinoma, intraductal papilloma)	N/A	NR

ETN50, etanercept 50 mg once a week subcutaneously; N/A, not applicable; NR, not reported.  
 ABT s.c. = ABT 125 mg once per week subcutaneously, following an optional i.v. loading dose of  $\approx$  10 mg/kg based on weight range.  
 ADA = ADA 40 mg every other week subcutaneously.  
 IFX = IFX 3 mg/kg intravenously at weeks 0, 2, 6 and every 8 weeks thereafter (with dose escalation permitted after week 12 if lack of response).  
 TCZ = TCZ 8 mg/kg intravenously every 4 weeks.

TABLE 393 Specific categories of AEs: populations 2 and 3 RCTs of biologic interventions vs. DMARD(s) or PBO

Trial name/ study	Treatment arms for which data extraction performed	RCT/LTE phase	Assessment time point	Number of patients experiencing one or more infection, n/N (%)	Number of patients experiencing one or more serious infection, n/N (%)	Number of patients experiencing any infection requiring antibiotics, n/N (%)	Number of patients experiencing one or more malignancy, n/N (%)	Number of patients experiencing one or more injection-site reaction (s.c. administration), n/N (%)	Number of patients experiencing one or more infection-related reaction (i.v. administration), n/N (%)
AIM <sup>62</sup>	PBO + MTX	RCT	12 months	NR	5/219 (2.3)	NR	NR	NR	Acute infusional AEs
	ABT i.v. + MTX	RCT	12 months	NR	17/433 (3.9)	NR	NR	NR	37/219 (16.9) Acute infusional AEs
AIM <sup>64</sup>	ABT i.v. + MTX 2 years or MTX + PBO 1 year then ABT i.v. + MTX 1 year	LTE	2 years	400/593 (67.5)	43/593 (7.3)	NR	NR	NR	38/433 (8.8) NR
ASSET <sup>72</sup>	PBO + MTX	RCT	4 months	6/23 (26.1)	0/23 (0)	NR	0/23 (0)	N/A	Acute infusion events: 4/23 (17.4)
	ABT i.v. + MTX	RCT	4 months	10/27 (37.0)	0/27 (0)	NR	0/27 (0)	N/A	Peri-infusional events: 5/23 (21.7) Acute infusion events: 0/27
ASSET <sup>72</sup>	ABT i.v. + MTX (OLE)	LTE	1 year	26/49 (53.1)	1/49 (2.0)	NR	0/49 (0)	N/A	Peri-infusional events: 4/27 (14.8) Acute infusion events: 2/49 (4.1) Peri-infusional events: 6/49 (12.2)

Trial name/ study	Treatment arms for which data extraction performed	RCT/LTE phase	Assessment time point	Number of patients experiencing one or more infection, n/N (%)	Number of patients experiencing one or more serious infection, n/N (%)	Number of patients experiencing any infection requiring antibiotics, n/N (%)	Number of patients experiencing one or more malignancy, n/N (%)	Number of patients experiencing one or more injection-site reaction (s.c. administration), n/N (%)	Number of patients experiencing one or more infusion-related reaction (i.v. administration), n/N (%)
ASSURE <sup>73</sup>	PBO + cDMARDs	RCT	1 year	224/418 (53.6)	7/418 (1.7)	NR	NR	NR	NR
	ABT + cDMARDs	RCT	1 year	470/856 (54.9)	22/856 (2.6)	NR	NR	NR	NR
AUGUST II <sup>76</sup>	PBO + MTX	38 week follow-up of 26-week RCT treatment	38 weeks	NR	1/76 (1.3)	NR	NR	NR	N/A
	ADA + MTX	38 week follow-up of 26-week RCT treatment	38 weeks	NR	3/79 (3.8)	NR	NR	NR	N/A
CHANGE <sup>80</sup>	PBO	RCT	24 weeks	32/87 (36.8)	1/87 (1.1)	NR	2/87 (2.3)	2/87 (2.3)	NR
	ADA monotherapy	RCT	24 weeks	41/91 (45.1)	6/91 (6.6)	NR	0 (0)	28/91 (30.8)	NR

continued

TABLE 393 Specific categories of AEs: populations 2 and 3 RCTs of biologic interventions vs. DMARD(s) or PBO (continued)

Trial name/ study	Treatment arms for which data extraction performed	RCT/LTE phase	Assessment time point	Number of patients experiencing one or more infection, n/N (%)	Number of patients experiencing one or more serious infection, n/N (%)	Number of patients experiencing any infection requiring antibiotics, n/N (%)	Number of patients experiencing one or more malignancy, n/N (%)	Number of patients experiencing one or more injection-site reaction (s.c. administration), n/N (%)	Number of patients experiencing one or more infusion-related reaction (i.v. administration), n/N (%)
DE019 <sup>84</sup>	PBO + MTX	RCT	52 weeks	Upper respiratory tract infection, 13.5%	NR	NR	0	48/200 (24%)	NR
	ADA + MTX	RCT	52 weeks	Infection, 4.5%	NR	NR	Across both ADA groups, four ADA-treated patients developed non-skin cancers, including non-Hodgkin's lymphoma, adenocarcinoma, testicular seminoma, and breast cancer (not stated which ADA group)	54/207 (26%)	NR
STAR <sup>117</sup>	PBO + cDMARDs	RCT	24 weeks	157/318 (49.4%)	6/318 (1.9%)	NR	0	37 (11.6%)	N/A
	ADA + cDMARDs	RCT	24 weeks	166 (52.2%)	4 (1.3%)	NR	1/318 (0.3)	62 (19.5%) <sup>a</sup>	N/A
Van De Putte <i>et al.</i> , 2004 <sup>122</sup>	PBO s.c.	RCT	26 weeks	NR	NR	NR	1/110 (0.9)	1/110 (0.9)	N/A
	ADA monotherapy	RCT	26 weeks	NR	NR	NR	4/434 (0.9) (of all four ADA groups)	11/113 (9.7)	N/A

Trial name/ study	Treatment arms for which data extraction performed	RCT/LTE phase	Assessment time point	Number of patients experiencing one or more infection, n/N (%)	Number of patients experiencing one or more serious infection, n/N (%)	Number of patients experiencing any infection requiring antibiotics, n/N (%)	Number of patients experiencing one or more malignancy, n/N (%)	Number of patients experiencing one or more injection-site reaction (s.c. administration), n/N (%)	Number of patients experiencing one or more infusion-related reaction (i.v. administration), n/N (%)
ARMADA <sup>69,70</sup>	PBO + MTX (n = 62)	RCT	24 weeks	Any infection, NR	NR	NR	NR	Pain, 3.2%	N/A
	ADA + MTX (n = 67)	RCT	24 weeks	Upper respiratory tract infection, 9.7%	NR	NR	NR	Reaction, 0%	
Kim <i>et al.</i> , 2007 <sup>99</sup>	PBO + MTX	RCT	24 weeks	Any infection, NR	NR	NR	NR	Pain, 10.4%	N/A
	ADA + MTX	RCT	24 weeks	Upper respiratory tract infection, 14.9%	NR	NR	NR	Reaction, 1.5%	
CERTAIN <sup>79</sup>	PBO + cDMARDs	RCT	24 weeks	NR	NR (1.0)	NR	NR		
	C TZ + DMARDs	RCT	24 weeks	NR	NR (2.1)	NR	NR		
ADORE <sup>59,60</sup>	ETN monotherapy	RCT	16 weeks	39/159 (24.5)	2/159 (1.3)	NR	NR		
	ETN + MTX	RCT	16 weeks	50/155 (32.3)	1/155 (0.6)	NR	NR		
CREATE IIb <sup>96</sup>	PBO + DMARD	RCT	24 weeks	NR	0/65	NR	NR		
	ETN50 + DMARD	RCT	24 weeks	NR	0/64	NR	NR		
ETN study 309 <sup>89</sup>	SSZ + PBO	RCT	24 weeks	13/50 (26)	0	NR	0	1/50 (2)	NR
	ETN + PBO	RCT	24 weeks	47/103 (45.6) <sup>a</sup> (vs. SSZ)	2/103 (1.9)	NR	2/103 (1.9)	33/103 (32.0) <sup>a</sup> (vs. SSZ)	NR
	ETN + SSZ	RCT	24 weeks	31/101 (30.7) <sup>a</sup> (vs. SSZ vs. ETN+PBO)	0	NR	0	16/101 (15.8) <sup>b</sup> (vs. SSZ vs. ETN+PBO)	NR

continued

TABLE 393 Specific categories of AEs: populations 2 and 3 RCTs of biologic interventions vs. DMARD(s) or PBO (continued)

Trial name/ study	Treatment arms for which data extraction performed	RCT/LTE phase	Assessment time point	Number of patients experiencing one or more infection, n/N (%)	Number of patients experiencing one or more serious infection, n/N (%)	Number of patients experiencing any infection requiring antibiotics, n/N (%)	Number of patients experiencing one or more malignancy, n/N (%)	Number of patients experiencing one or more injection-site reaction (s.c. administration), n/N (%)	Number of patients experiencing one or more infusion-related reaction (i.v. administration), n/N (%)
ETN309 <sup>89</sup>	SSZ + PBO	RCT	2 years	21/50 (42.0)	NR	NR	NR	2/50 (4.0)	NR
	ETN + PBO	RCT	2 years	76/103 (73.8) <sup>a</sup> (vs. SSZ)	NR	NR	NR	34/103 (33.0) <sup>a</sup> (vs. SSZ)	NR
	ETN + SSZ	RCT	2 years	60/101 (59.4) <sup>a</sup> (vs. ETN+PBO)	NR	NR	NR	21/101 (20.8) <sup>a</sup> (vs. SSZ)	NR
JESMR <sup>140</sup>	ETN monotherapy	RCT	52 weeks	19/71 (26.8)	0/71	NR	NR	13/71 (18.3)	NR
	ETN + MTX	RCT	52 weeks	21/76 (27.6)	2/76 (2.6)	NR	NR	7/76 (9.2)	NR
Lan <i>et al.</i> , 2004 <sup>101</sup>	PBO + MTX	RCT	12 weeks	NR	NR	NR	NR	0/29	NR
	ETN + MTX	RCT	12 weeks	NR	NR	NR	NR	1/29 (3.4)	NR
LARA <sup>102</sup>	MTX + DMARD	RCT	24 weeks	31/142 (21.8)	0	NR	NR	NR	NR
	ETN50 + MTX	RCT	24 weeks	107/281 (38.1) <sup>a</sup>	5/281 (1.8)	NR	NR	NR	NR
Moreland <i>et al.</i> , 1999 <sup>104</sup>	PBO	RCT	6 months	NR	NR	NR	NR	10/80 (13)	NR
	ETN + PBO	RCT	6 months	NR	NR	NR	NR	38/78 (49) <sup>b</sup>	NR



Trial name/ study	Treatment arms for which data extraction performed	RCT/LTE phase	Assessment time point	Number of patients experiencing one or more infection, n/N (%)	Number of patients experiencing one or more serious infection, n/N (%)	Number of patients experiencing any infection requiring antibiotics, n/N (%)	Number of patients experiencing one or more malignancy, n/N (%)	Number of patients experiencing one or more injection-site reaction (s.c. administration), n/N (%)	Number of patients experiencing one or more infection-related reaction (i.v. administration), n/N (%)
RACAT <sup>11</sup>	MTX + SSZ + HCQ  On treatment analysis, n = 222 (some patients exposed to both treatments throughout trial)	RCT including crossover	48 weeks	56/222 (25.2)	4/222 (1.8)	NR	NR	NR	NR
	ETN50 + MTX  On treatment analysis, n = 219 (some patients exposed to both treatments throughout trial)	RCT including crossover	48 weeks	82/219 (37.4)	9/219 (4.1)	NR	NR	NR	NR
Wajdula 2000 (reported in Chen <i>et al.</i> , 2006 <sup>23</sup> )	PBO  ETN	RCT  RCT	12 weeks  12 weeks	NR  NR	NR  NR	NR  NR	1/105 (1.0)  0/111	NR  NR	NR  NR
Weinblatt <i>et al.</i> , 1999 <sup>24</sup>	PBO + MTX  ETN + MTX	RCT  RCT	24 weeks  24 weeks	19/30 (63)  30/59 (51)	NR  NR	NR  NR	NR  NR	21/30 (7)  25/59 (42)	NR  NR
Kremer <i>et al.</i> , 2003 <sup>60</sup> (LTE of Weinblatt <i>et al.</i> , 1999 <sup>24</sup> )	ETN + MTX or MTX + PBO followed by ETN + MTX (n = 79)	LTE	3-year LTE	NR	4/79 (5.1) required hospitalisation	NR	3/79 (3.8)	NR	NR
GO-FORTH <sup>91</sup>	PBO + MTX  GOL + MTX	RCT  RCT	24 weeks  24 weeks	39/88 (44.3)  36/86 (41.9)	0/88  0/86	NR  NR	0/88  0/86	7/88 (8.0)  8/86 (9.3)	N/A  N/A

continued

**TABLE 393** Specific categories of AEs: populations 2 and 3 RCTs of biologic interventions vs. DMARD(s) or PBO (continued)

Trial name/ study	Treatment arms for which data extraction performed	RCT/LTE phase	Assessment time point	Number of patients experiencing one or more serious infection, n/N (%)	Number of patients experiencing one or more infection requiring antibiotics, n/N (%)	Number of patients experiencing one or more malignancy, n/N (%)	Number of patients experiencing one or more injection-site reaction (s.c. administration), n/N (%)	Number of patients experiencing one or more infusion-related reaction (i.v. administration), n/N (%)
GO-FORWARD <sup>92</sup>	PBO + MTX	RCT	24 weeks	1/134 (0.7) (Urinary tract infection)	NR	1/134 (0.7) (Basal cell cancer)	4/134 (3.0)	N/A
	GOL + MTX	RCT	24 weeks	2/212 (0.9)	NR	0	5/212 (2.4)	N/A
				(One cellulitis, one s.c. abscess)				
GO-FORWARD <sup>92</sup>	PBO + MTX	RCT	52 weeks	1/133 (0.8)	NR	2/133 (1.5)	4/133 (3.0)	N/A
	GOL + MTX	RCT	52 weeks	4/212 (1.9)	NR	3/212 (1.4)	10/212 (4.7)	N/A
Kay <i>et al.</i> , 2008 <sup>98</sup>	IFX + MTX (PBO group crossed over to IFX at week 20)	RCT	52 weeks	1/25 (4.0)	NR	0/25	N/A	NR
	GOL + MTX	RCT	52 weeks	1/37 (2.7)	NR	1/37 (2.7)	6/37 (16.2)	N/A
Abe <i>et al.</i> , 2006 <sup>56</sup>	PBO + MTX	RCT	14 weeks	NR (Pneumonia = 0)	NR	NR	N/A	17/47 (36.2)
	IFX + MTX	RCT	14 weeks	NR	NR	NR	N/A	23/49 (46.9)
				[Pneumonia = 1 (2.0)]				
Abe <i>et al.</i> , 2006 <sup>56</sup>	PBO group crossover to IFX	LTE	To week 36 of LTE	NR	NR	NR	N/A	17/41 (41.5)
	IFX + MTX	LTE	To week 36 of LTE	NR	NR	NR	N/A	33/49 (67.3)

Trial name/ study	Treatment arms for which data extraction performed	RCT/LTE phase	Assessment time point	Number of patients experiencing one or more infection, n/N (%)	Number of patients experiencing one or more serious infection, n/N (%)	Number of patients experiencing any infection requiring antibiotics, n/N (%)	Number of patients experiencing one or more malignancy, n/N (%)	Number of patients experiencing one or more injection-site reaction (s.c. administration), n/N (%)	Number of patients experiencing one or more infection-related reaction (i.v. administration), n/N (%)
ATTRACT <sup>75</sup> / Lipsky <i>et al.</i> , 2000 <sup>146</sup>	PBO i.v. + MTX	RCT	54 weeks	NR	7/86 (8.1)	35%	0	N/A	Serious infusion reactions = 0
	IFX + MTX	RCT	54 weeks	NR	2/88 (2.3)	NR	0	N/A	0
ATTRACT <sup>75</sup> / Maini <i>et al.</i> , 2004 <sup>324</sup>	PBO i.v. + MTX	LTE	102 weeks	NR	11/NR (13)	NR	1/NR (1)	N/A	Serious infusion reactions = 0
	IFX + MTX	LTE	102 weeks	NR	10/NR (11)	NR	1/NR (1)	N/A	Serious infusion reactions = 0
Durez <i>et al.</i> , 2004 <sup>86</sup>	MP + MTX	RCT	14 weeks (n unclear)	NR	0/NR	NR	NR	N/A	0/NR
	IFX + MTX		14 weeks (n unclear)	NR	0/NR	NR	NR	N/A	0/NR
START <sup>118</sup>	PBO + MTX	RCT	22 weeks	38/361 (10.5)	6/361 (1.7)		0/361		Serious infusion reactions: 1/361 (0.3)
	IFX + MTX	RCT	22 weeks	35/360 (9.7) (Upper respiratory tract infection)	6/360 (1.7)		2/360 (0.6)		Serious infusion reactions = 0
START <sup>118</sup>	IFX + MTX (not dose escalated)	LTE	54 weeks	119/244 (49) (Upper respiratory tract infection)	11/244 (4.5)		1/244 (0.4)		Serious infusion reactions: 2/244 (0.8)
Swefot <sup>119</sup>	SSZ + HCQ + MTX	RCT	24 months	AEs = 1/130 (0.8)	NR	NR	AEs = 0	NR	NR
	IFX + MTX	RCT	24 months	AEs = 8/128 (6.3)	NR	NR	AEs = 1/128 (0.8)	NR	NR

continued

TABLE 393 Specific categories of AEs: populations 2 and 3 RCTs of biologic interventions vs. DMARD(s) or PBO (continued)

Trial name/ study	Treatment arms for which data extraction performed	RCT/LTE phase	Assessment time point	Number of patients experiencing one or more infection, n/N (%)	Number of patients experiencing one or more serious infection, n/N (%)	Number of patients experiencing any infection requiring antibiotics, n/N (%)	Number of patients experiencing one or more malignancy, n/N (%)	Number of patients experiencing one or more injection-site reaction (s.c. administration), n/N (%)	Number of patients experiencing one or more reaction (i.v. administration), n/N (%)
ACT-RAY <sup>152</sup>	TCZ + oral PBO	RCT	52 weeks	NR	9/276 (3.3)	NR	NR	N/A	NR
	TCZ + MTX	RCT	52 weeks	NR	10/277 (3.6)	NR	NR	N/A	NR
Nishimoto <i>et al.</i> , 2004 <sup>106</sup>	PBO	RCT	12 weeks	NR	NR	NR	NR	N/A	15%
	TCZ	RCT	12 weeks	NR	NR	NR	NR	N/A	16%
STREAM <sup>325</sup> (LTE of Nishimoto <i>et al.</i> , 2004 <sup>106</sup> )	PBO	LTE	To year 5	-	-	-	-	-	-
	TCZ	LTE	To year 5	NR	25/143 (17.5)	NR	4/143 (2.8)	N/A	NR
							(Bladder cancer, breast cancer, large intestine carcinoma, intraductal papilloma)		
SAMURAI <sup>115</sup>	gDMARDs	RCT	52 weeks	NR	8/145 (5.5)	NR	0/145	NR	N/A
	TCZ	RCT	52 weeks	NR	12/157 (7.6)	NR	3/157 (1.9)	NR	11/157 (7.0)
SATORI <sup>116</sup>	PBO + MTX	RCT	24 weeks	NR	NR	NR	NR	N/A	NR
	TCZ + PBO capsules	RCT	24 weeks	NR	NR	NR	NR	N/A	7/61 (11.5)
TOWARD <sup>121</sup>	PBO i.v. + stable gDMARDs	RCT	24 weeks	131/414 (31.6)	8/414 (1.9)	NR	NR	N/A	NR
	TCZ + stable DMARDs	RCT	24 weeks	300/802 (37.4)	22/802 (2.7)	NR	NR	N/A	NR

Trial name/ study	Treatment arms for which data extraction performed	RCT/LTE phase	Assessment time point	Number of patients experiencing one or more infection, <i>n/N</i> (%)	Number of patients experiencing any infection requiring antibiotics, <i>n/N</i> (%)	Number of patients experiencing one or more malignancy, <i>n/N</i> (%)	Number of patients experiencing one or more injection-site reaction (s.c. administration), <i>n/N</i> (%)	Number of patients experiencing one or more infusion-related reaction (i.v. administration), <i>n/N</i> (%)
TACIT <sup>141</sup>	Combination cDMARDs	AiC information has been removed	AiC information has been removed	AiC information has been removed	AiC information has been removed	AiC information has been removed	AiC information has been removed	AiC information has been removed
	TNF inhibitor + DMARD	AiC information has been removed	AiC information has been removed	AiC information has been removed	AiC information has been removed	AiC information has been removed	AiC information has been removed	AiC information has been removed

AIM, Abatacept in Inadequate responders to Methotrexate; ASSET, Abatacept Systemic SclErosis Trial; CHANGE, Clinical investigation in Highly disease-affected rheumatoid Arthritis patients in Japan with Adalimumab applying staMard and General Evaluation study; ETN50, etanercept 50 mg once a week subcutaneously; N/A, not applicable; NR, not reported; OLE, open label extension; SATORI, Study of Active controlled Tocilizumab for Rheumatoid arthritis patients with an inadequate response to methotrexate; STAR, Safety Trial of Adalimumab in Rheumatoid arthritis.

ABT i.v. = BT ≈ 10 mg/kg intravenously on weeks 0, 2 and 4, and every 4 weeks thereafter.

ADA = ADA 40 mg every other week subcutaneously.

CTZ = s.c. CTZ 400 mg at weeks 1, 2 and 4, then 200 mg every other week.

ETN = ETN 25 mg twice a week subcutaneously.

GOL = GOL 50 mg every 4 weeks subcutaneously.

IFX = IFX 3 mg/kg intravenously at weeks 0, 2, 6 and every 8 weeks thereafter (with dose escalation permitted after week 12 if lack of response).

TCZ = TCZ 8 mg/kg intravenously every 4 weeks.

a *p* < 0.05.

b *p* < 0.01.

TABLE 394 Number of deaths: population 1 RCTs biologic vs. cDMARD(s) or PBO

Trial name/ study	Treatment arms for which data extraction performed	Assessment time point	Deaths, n/N (%)	Cause of death	Considered by investigators/ adjudicators to be related to study drug?
GUEPARD <sup>93</sup>	Initial MTX 12 weeks, then step-up therapy in both groups based on DAS28	1 year	0/32	N/A	N/A
	Initial ADA + MTX 12 weeks, then step-up therapy in both groups based on DAS28 RACAT	1 year	0/33	N/A	N/A
HIT HARD <sup>94</sup>	MTX + PBO for 24 weeks followed by OL MTX for 24 weeks	48 weeks	0/85	N/A	N/A
	ADA + MTX for 24 weeks followed by OL MTX for 24 weeks	48 weeks	0/87	N/A	N/A
OPERA <sup>107</sup>	MTX + PBO + steroid	12 months	1/91 (1.1)	Pneumonia 4 months after terminating the study	NR
	ADA + MTX + steroid	12 months	0/89	N/A	N/A
PREMIER <sup>109</sup>	MTX + PBO	2 years	1/257 (0.4)	Pneumonia	NR
	ADA monotherapy + PBO	2 years	4/274 (1.5)	One chronic obstructive pulmonary disease/pulmonary disease and pulmonary hypertension sudden death; one metastatic liver cancer (unknown primary); one metastatic colon cancer; one liver failure (pre-existing cirrhosis)	NR
PREMIER <sup>109</sup>	ADA + MTX	2 years	1/268 (0.4)	Ovarian cancer	NR
	MTX + PBO to OL ADA monotherapy	5 years LTE	NR (0.6)	NR	NR
	ADA monotherapy + PBO to OL ADA monotherapy	5 years LTE	NR (0.6)	NR	NR
	ADA + MTX to OL ADA monotherapy	5 years LTE	NR (1.1)	NR	NR
COMET <sup>93</sup>	MTX in year 1, MTX in year 2	2 years	1/99	Pneumonia and adenocarcinoma of the lungs with metastasis	NR
	MTX in year 1, ETN + MTX in year 2	2 years	0	N/A	N/A
	ETN + MTX in year 1, ETN + MTX in year 2	2 years	0	N/A	N/A
	ETN + MTX in year 1, ETN in year 2	2 years	1/111	Pneumonia	NR

**TABLE 394** Number of deaths: population 1 RCTs biologic vs. cDMARD(s) or PBO (*continued*)

Trial name/ study	Treatment arms for which data extraction performed	Assessment time point	Deaths, n/N (%)	Cause of death	Considered by investigators/ adjudicators to be related to study drug?
ERA <sup>139</sup>	MTX + PBO	12 months	0/217 (0)	N/A	N/A
	ETN + PBO	12 months	1/207 (0.5)	Non-infectious complications resulting from dissection of a pre-existing aortic aneurysm	NR
ERA <sup>139</sup>	MTX + PBO	2 years	0/217 (0)	N/A	N/A
	ETN + PBO	2 years	1/207 (0.5)	See above	N/A
GO-BEFORE <sup>143</sup>	PBO + MTX	RCT 24 weeks	0	N/A	N/A
	GOL + MTX	RCT 24 weeks	1	Suicide	NR
GO-BEFORE <sup>143</sup>	PBO + MTX	LTE 104 weeks	0	N/A	N/A
	GOL + MTX	LTE 104 weeks	4/159 (2.5)	One hypoglycaemic coma, one lung cancer, one septic shock, one probable non-small cell lung cancer	NR
ASPIRE <sup>71</sup>	PBO i.v. + MTX	RCT 54 weeks	2	One due to respiratory failure attributed to MTX-related drug toxicity, one due to upper gastrointestinal bleed	NR
	IFX + MTX	RCT 54 weeks	1	Cardiac arrest	NR
Durez <i>et al.</i> , 2007 <sup>120</sup>	MTX	52 weeks	0/14	N/A	N/A
	MTX + MP	52 weeks	0/15	N/A	N/A
	IFX + MTX	52 weeks	0/15	N/A	N/A

ASPIRE, Active controlled Study of Patients receiving Infliximab for the treatment of Rheumatoid arthritis of Early onset; ERA, Early Rheumatoid Arthritis (etanercept); HIT HARD, High Induction Therapy with Anti-Rheumatic Drugs (adalimumab and methotrexate); N/A, not applicable; NR, not reported; OL, open label.

ADA = ADA 40 mg every other week subcutaneously.

CTZ = s.c. CTZ 400 mg at weeks 1, 2 and 4, then 200 mg every other week.

ETN = ETN 25 mg twice a week subcutaneously.

GOL = GOL 50 mg every 4 weeks subcutaneously.

IFX = IFX 3 mg/kg intravenously at weeks 0, 2, 6 and every 8 weeks thereafter (with dose escalation permitted after week 12 if lack of response).

TABLE 395 Number of deaths: populations 2 and 3 head-to-head biologic RCTs

Trial name	Treatment arms for which data extraction performed	Assessment time point	Deaths, n/N	Cause of death	Considered by investigators/adjudicators to be related to study drug?
ATTEST <sup>74</sup>	PBO + MTX	RCT day 197	0	N/A	N/A
	IFX + MTX	RCT day 197	1/165	Cerebrovascular accident	NR
	ABT + MTX	RCT day 197	1/156	Fibrosarcoma	NR
ATTEST <sup>74</sup>	PBO + MTX	RCT day 365	No further deaths	N/A	N/A
	IFX + MTX	RCT day 365	One additional death	Patient with peritoneal tuberculosis, death due to septic shock following surgery	NR
	ABT + MTX	RCT day 365	No further deaths	N/A	N/A
AMPLE <sup>66</sup>	ABT s.c.	1 year	1/318	Sudden cardiac arrest	No
	ADA	1 year	0/328	N/A	N/A
RED-SEA <sup>114</sup>	ADA + cDMARDs	12 months	2/60	Both ischaemic heart disease	NR
	ETN50 + cDMARDs	12 months	0/60	N/A	N/A
ADACTA <sup>58</sup>	TCZ + oral PBO	24 weeks	2/162	One sudden death, one illicit drug overdose	Overdose considered by study team unrelated to study drug. Sudden death considered by study team to be possibly related to study drug (unautopsied)
	ADA + i.v. PBO	24 weeks	0	N/A	N/A

ETN50, etanercept 50 mg once a week subcutaneously; N/A, not applicable; NR, not reported.

ABT s.c. = ABT 125 mg once per week subcutaneously, following an optional i.v. loading dose of  $\approx$  10 mg/kg based on weight range.

ADA = ADA 40 mg every other week subcutaneously.

IFX = IFX 3 mg/kg intravenously at weeks 0, 2, 6 and every 8 weeks thereafter (with dose escalation permitted after week 12 if lack of response).

TCZ = TCZ 8 mg/kg intravenously every 4 weeks.



TABLE 396 Number of deaths: populations 2 and 3 RCTs biologic vs. cDMARD(s) or PBO

Trial name/ study	Treatment arms for which data extraction performed	Assessment time point	Deaths, n/N	Cause of death	Considered by investigators/adjudicators to be related to study drug?
AIM <sup>61,62</sup>	MTX + PBO ABT i.v. + MTX	12 months 12 months	1/219 1/433	Pneumonia, sepsis, and multiorgan failure History of tuberculosis, asbestos exposure and pulmonary fibrosis, died of bronchopneumonia, pulmonary aspergillosis, and septicaemia	NR NR
AIM <sup>65</sup>	ABT i.v. + MTX 2 years or MTX + PBO 1 year then ABT i.v. + MTX 1 year	LTE 3 years	9/593 during LTE	Myocardial ischaemia with postprocedural complications, lobar pneumonia, lung cancer, pneumonia/sepsis, malignant melanoma, aortic aneurysm, three cases of cardiac arrest	NR
ASSET <sup>72</sup>	PBO + MTX	4 months	0/23	N/A	N/A
	ABT i.v. + MTX	4 months	0/27	N/A	N/A
ASSET <sup>72</sup>	ABT i.v. + MTX	1-year LTE	0/49	N/A	N/A
ASSURE <sup>73</sup>	PBO + cDMARDs ABT + cDMARDs	1 year 1 year	4/418 (1.0%) 5/856 (0.6%)	Congestive heart failure, cardiopulmonary arrest, cardiac arrest, pneumonia Hypertensive heart disease, coronary atherosclerosis/acute ischaemic cardiopathy, central atherosclerosis/advanced coronary atherosclerosis with focal stenosis, cardiac arrest	Three no, one possibly Four no, one cannot tell (unautopsied)
AUGUST II <sup>76</sup>	MTX + PBO	38-week follow-up of 26-week RCT treatment	0/76	N/A	N/A
	ADA + MTX	38-week follow-up of 26-week RCT treatment	0/79	N/A	N/A
CHANGE <sup>80</sup>	PBO ADA monotherapy	24 weeks 24 weeks	0/87 1/91 (1.1%)	N/A Interstitial lung disease and lung infection	N/A Considered possibly related to treatment

continued

TABLE 396 Number of deaths: populations 2 and 3 RCTs biologic vs. cDMARD(s) or PBO (continued)

Trial name/ study	Treatment arms for which data extraction performed	Assessment time point	Deaths, n/N	Cause of death	Considered by investigators/adjudicators to be related to study drug?
DE019 <sup>84</sup>	MTX + PBO ADA + MTX	52 weeks 52 weeks	0/200 2/207	N/A One related to multiple fractures and one related to urosepsis	N/A NR
STAR <sup>117</sup>	PBO + cDMARDs ADA + cDMARDs	24 weeks 24 weeks	0/318 1/318 (0.3%)	N/A Secondary streptococcal A superinfection	N/A NR
Van De Putte <i>et al.</i> , 2004 <sup>122</sup>	PBO s.c. ADA monotherapy	26 weeks 26 weeks	1 Three in ADA group (dose not specified)	Complications of bowel obstruction Metastatic adenocarcinoma, cholangiocarcinoma, and myocardial infarction	All stated by authors to be unrelated or unlikely to be related to study drug
ARMADA <sup>69</sup>	MTX + PBO ADA + MTX	24 weeks 24 weeks	0/62 0/67	N/A N/A	N/A N/A
ARMADA <sup>70</sup>	ADA + MTX	4 years LTE	6/262	Congestive heart failure, acute myocardial insufficiency, aortic aneurysm previously treated surgically, cerebrovascular accident, intracranial haemorrhage, acute kidney failure	NR
Kim <i>et al.</i> , 2007 <sup>99</sup>	MTX + PBO ADA + MTX	24 weeks	0/63 1/65	N/A Acute respiratory distress syndrome	N/A NR
ADORE <sup>59,60</sup>	ETN monotherapy ETN + MTX	16 weeks 16 weeks	0/159 3/155	N/A Cardiac arrhythmia that occurred 1 month after the patient discontinued study drugs, second due to cardiac arrest and third due to massive cerebral haemorrhage	N/A All considered to be unrelated to study drugs by the investigator
CREATE IIb <sup>96</sup>	DMARD + PBO ETN50 + DMARD	24 weeks 24 weeks	0/65 0/64	N/A N/A	N/A N/A

Trial name/ study	Treatment arms for which data extraction performed	Assessment time point	Deaths, n/N	Cause of death	Considered by investigators/adjudicators to be related to study drug?
ETN study 309 <sup>89</sup>	SSZ + PBO ETN + PBO ETN + SSZ MTX + SSZ + HCQ	24 weeks 24 weeks 24 weeks 48 weeks	0/50 0/103 0/101 0/222	N/A N/A N/A N/A	N/A N/A N/A N/A
RACAT <sup>111</sup>	On treatment analysis, n = 222 (some patients exposed to both treatments throughout trial) ETN50 + MTX	48 weeks	n = 1 (0.5%)	Pneumonia	NR
Weinblatt <i>et al.</i> 1999 <sup>60</sup>	On treatment analysis, n = 219 (some patients exposed to both treatments throughout trial) PBO + MTX	24 weeks (and 30 days after treatment)	0/30	N/A	N/A
Weinblatt <i>et al.</i> 1999 <sup>60</sup>	ETN 25 mg twice weekly + MTX	24 weeks (and 30 days after treatment)	0/59	N/A	N/A
Weinblatt <i>et al.</i> 1999 <sup>60</sup>	ETN + MTX or MTX + PBO followed by ETN + MTX	3-year LTE	1/79	Myocardial infarction	NR
APPEAL <sup>67,68</sup>	MTX + DMARD (SSZ, HCQ or LEF) ETN + MTX	16 weeks 16 weeks (study RCT end point)	0/103 1/197 (0.5%)	N/A Gastrointestinal haemorrhage thought to be result of NSAID therapy following accidental fall and pelvic fracture	N/A No

continued

TABLE 396 Number of deaths: populations 2 and 3 RCTs biologic vs. cDMARD(s) or PBO (continued)

Trial name/ study	Treatment arms for which data extraction performed	Assessment time point	Deaths, n/N	Cause of death	Considered by investigators/adjudicators to be related to study drug?
GO-FORTH <sup>91</sup>	PBO + MTX	24 weeks	0/88	N/A	N/A
	GOL + MTX	24 weeks	0/86	N/A	N/A
GO-FORWARD <sup>92</sup>	PBO + MTX	24 weeks	0/133	N/A	N/A
	GOL + MTX	24 weeks	0/89	N/A	N/A
			One death in unlicensed GOL 100 mg every 4 weeks arm (ileus, aspiration pneumonia and death from sepsis)		
Kay <i>et al.</i> , 2008 <sup>98</sup>	PBO + MTX (crossover to IFX + MTX at week 20)	52 weeks	0/35	N/A	N/A
	GOL + MTX	52 weeks	0/35	N/A	N/A
Abe <i>et al.</i> , 2006 <sup>56</sup>	PBO + MTX	14 weeks	0/47	N/A	N/A
	IFX + MTX	14 weeks	0/49 [two deaths but not in 3 mg/kg extracted dose (both due to pneumonia)]	NR	NR
Abe <i>et al.</i> , 2006 <sup>56</sup>	PBO group crossover to IFX	To week 36 of LTE	N/A	N/A	N/A
	IFX + MTX	To week 36 of LTE	0/129	N/A	N/A
ATTRACT <sup>324</sup>	PBO + MTX	LTE 102 weeks	4/88 (4.5%)	Left ventricle rupture resulting in cardiopulmonary arrest, intestinal gangrene, arrhythmia and cardiopulmonary failure	Judged to be unrelated to study drug
	IFX + MTX	LTE 102 weeks	3/86 (3.5%)	Not reported separately for extracted arm	NR

Trial name/ study	Treatment arms for which data extraction performed	Assessment time point	Deaths, <i>n/N</i>	Cause of death	Considered by investigators/adjudicators to be related to study drug?
START <sup>18</sup>	PBO + MTX IFX + MTX	22 weeks 22 weeks	1/361 0/360	Septic shock N/A	NR N/A
SweFot <sup>147</sup>	SSZ + HCQ + MTX IFX + MTX	24 months 24 months	0/130 1/128 (0.8%)	N/A Complications of acute myeloid leukaemia	N/A NR
ACT-RAY <sup>57</sup>	TCZ + oral PBO	To week 52	2/276 (0.7%)	Causes of death in four patients: septic shock preceded by scrotal abscess, skin necrosis, acute renal failure and congestive heart failure, myocardial infarction, and sepsis with meningitis	NR
Nishimoto <i>et al.</i> , 2004 <sup>106</sup>	TCZ + MTX PBO TCZ	To week 52 12 weeks 12 weeks	2/277 (0.7%) 0/53 1/55 (1.8%)	NR N/A Due to reactivation of chronic Epstein-Barr virus and consequent haemophagocytosis syndrome 61 days after single dose of TCZ 8 mg/kg i.v.	NR N/A NR
TOWARD <sup>21</sup>	PBO i.v. + stable cDMARDs TCZ + stable DMARDs	24 weeks 24 weeks	2/413 (0.5%) 2/803 (0.3%)	Pneumonia, intestinal obstruction Haemorrhagic stroke, postprocedural complications from triple coronary artery bypass graft	NR NR

continued

TABLE 396 Number of deaths: populations 2 and 3 RCTs biologic vs. cDMARD(s) or PBO (continued)

Trial name/ study	Treatment arms for which data extraction performed	Assessment time point	Deaths, n/N	Cause of death	Considered by investigators/adjudicators to be related to study drug?
TACIT <sup>141</sup>	Combination cDMARDs	AiC information has been removed	AiC information has been removed	AiC information has been removed	AiC information has been removed
	TNF inhibitor + DMARD	AiC information has been removed	AiC information has been removed	AiC information has been removed	AiC information has been removed
TACIT <sup>141</sup>	Combination cDMARDs	AiC information has been removed	AiC information has been removed	AiC information has been removed	AiC information has been removed
	TNF inhibitor + DMARD	AiC information has been removed	AiC information has been removed	AiC information has been removed	AiC information has been removed

AIM, Abatacept in Inadequate responders to Methotrexate; ASSET, Abatacept Systemic Sclerosis Trial; CHANGE, Clinical investigation in Highly disease-affected rheumatoid Arthritis patients in Japan with Adalimumab applying standard and General Evaluation study; ETN50, etanercept 50 mg once a week subcutaneously; N/A, not applicable; NR, not reported;  
 STAR, Safety Trial of Adalimumab in Rheumatoid arthritis.  
 ABT i.v. = BT ≈ 10 mg/kg intravenously on weeks 0, 2 and 4, and every 4 weeks thereafter.  
 ADA = ADA 40 mg every other week subcutaneously.  
 ETN = ETN 25 mg twice a week subcutaneously.  
 GOL = GOL 50 mg every 4 weeks subcutaneously.  
 IFX = IFX 3 mg/kg intravenously at weeks 0, 2, 6 and every 8 weeks thereafter (with dose escalation permitted after week 12 if lack of response).  
 TCZ = TCZ 8 mg/kg intravenously every 4 weeks.



A decorative graphic consisting of numerous thin, parallel green lines that curve from the left side of the page towards the right, creating a sense of movement and depth.

**EME  
HS&DR  
HTA  
PGfAR  
PHR**

Part of the NIHR Journals Library  
[www.journalslibrary.nihr.ac.uk](http://www.journalslibrary.nihr.ac.uk)

*This report presents independent research funded by the National Institute for Health Research (NIHR). The views expressed are those of the author(s) and not necessarily those of the NHS, the NIHR or the Department of Health*

***Published by the NIHR Journals Library***