



**UNIVERSITY OF LEEDS**

This is a repository copy of *Advancement of natural ventilation technologies for sustainable development*.

White Rose Research Online URL for this paper:

<https://eprints.whiterose.ac.uk/80251/>

Version: Accepted Version

---

**Proceedings Paper:**

Calautit, JKS, Hughes, BR and Chaudhry, H (2012) Advancement of natural ventilation technologies for sustainable development. In: Earth Systems Engineering 2012: A technical symposium on systems engineering for sustainable adaptation to global change (2012). Earth Systems Engineering 2012: A technical symposium on systems engineering for sustainable adaptation to global change (2012), 03-05 Jul 2014, University of Leeds, Leeds, UK. Centre for Earth Systems Engineering Research, Newcastle University , ? - ? (26).

---

**Reuse**

Items deposited in White Rose Research Online are protected by copyright, with all rights reserved unless indicated otherwise. They may be downloaded and/or printed for private study, or other acts as permitted by national copyright laws. The publisher or other rights holders may allow further reproduction and re-use of the full text version. This is indicated by the licence information on the White Rose Research Online record for the item.

**Takedown**

If you consider content in White Rose Research Online to be in breach of UK law, please notify us by emailing [eprints@whiterose.ac.uk](mailto:eprints@whiterose.ac.uk) including the URL of the record and the reason for the withdrawal request.



[eprints@whiterose.ac.uk](mailto:eprints@whiterose.ac.uk)  
<https://eprints.whiterose.ac.uk/>



# Advanced Natural Ventilation Technologies for Sustainable Development

Dr Ben Richard Hughes *Wh.S.Sch*  
Earth Systems Engineering Symposium  
4<sup>th</sup> July 2012

# Introduction



UNIVERSITY OF LEEDS

Buildings worldwide account 40% of global energy consumption, and the resulting carbon footprint, significantly exceeding those of all transportation combined.

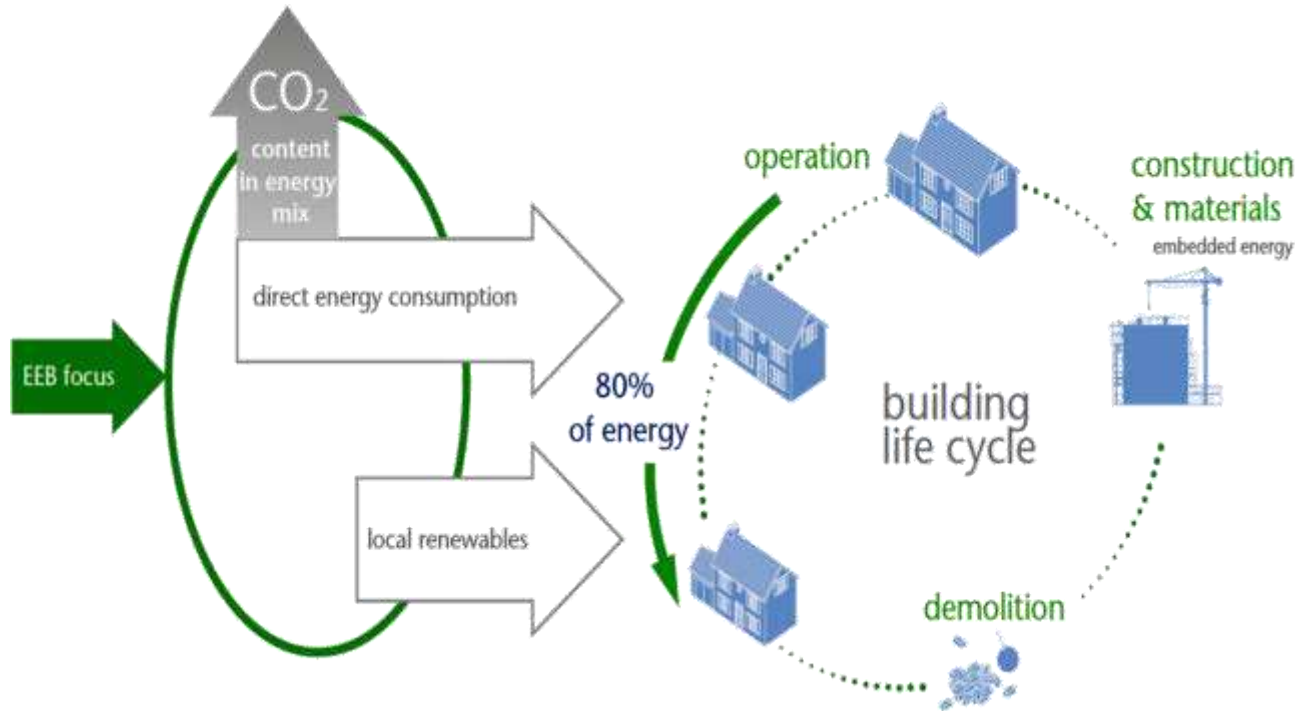

Building energy usage over lifetime  
(WBCSD, 2009)



# Where is it used ?

Growth in appliance use in 19 countries

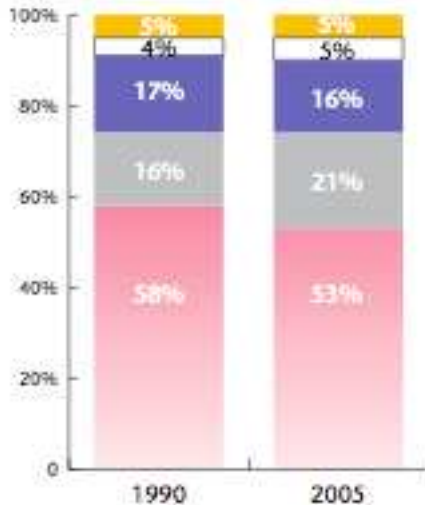

- Space heating equipment & distribution
- Appliances
- Water heating
- Lighting equipment
- Cooking

(Source: International Energy Agency, 2008, Worldwide Trends in Energy Use and Efficiency (data represent IEA19 countries))

50-60% of building energy usage is associated with HVAC systems, the trend has dropped not due to a reduction in usage but due to an increase in appliance usage.

The developing world expects a greater level of living standards, therefore we need to be able to meet these expectations whilst reducing energy.

# So why are we using HVAC?



UNIVERSITY OF LEEDS

Because we demand comfort

Because we need good air quality to maintain health

Because its reliable

Because we can control it

Therefore these four factors are the primary challenges for engineers to maintain whilst reducing energy consumption

# Advanced Naturally Ventilated Buildings



UNIVERSITY OF LEEDS

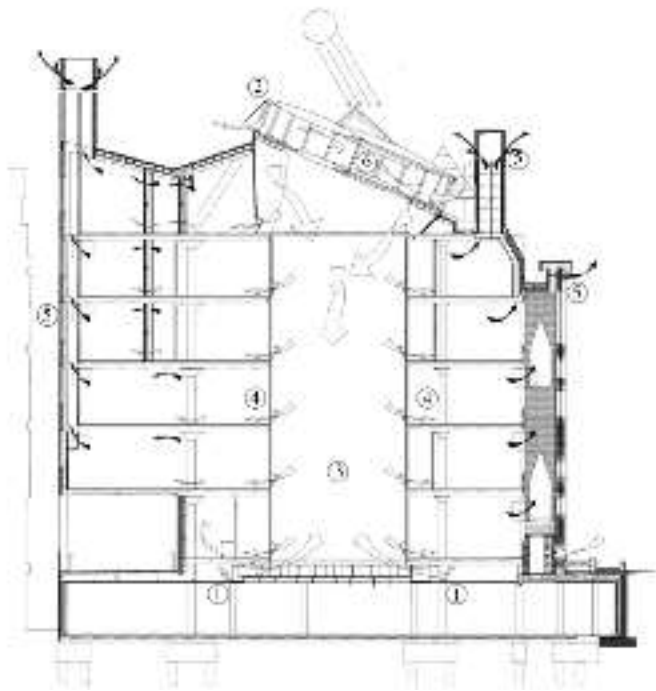

- 1 Intake dampers at lightwell base open.
- 2 Intake dampers at lightwell head open.
- 3 Lightwell fills with air at ambient temperature.
- 4 Air enters floors at low level via bottom hung windows.
- 5 Air exits at breathing parapet and via stacks.
- 6 Void between inner and outer ETT's layers vented.

ANV buildings create openings in the building at the design stage to allow air to flow throughout negating the requirements for ventilation systems.

Positioning of glazing to maximise solar gain reduces the space heating requirements.

However two of the four factors remain uncertain:

- |   |             |
|---|-------------|
| 1 | Reliability |
| 2 | Control     |

# Reliability and control



UNIVERSITY OF LEEDS

Reliability and control have long been the two factors which present the barrier to implementation of natural ventilation into commercial and domestic buildings.

As natural ventilation relies on external wind conditions we can guarantee ventilation rates, the higher the wind speed the faster the airflow into the building, when external wind speed is low there may not be enough airflow to meet legislative requirements.

Controlling the airflow into the building does not only rely on external wind speed but also temperatures, which in turn drives internal occupants thermal comfort.

It is clear then that opening in buildings does not resolve the HVAC requirements, therefore a device which creates reliable and controllable airflow offers the greatest opportunities for HVAC energy consumption reduction:

The Wind Tower

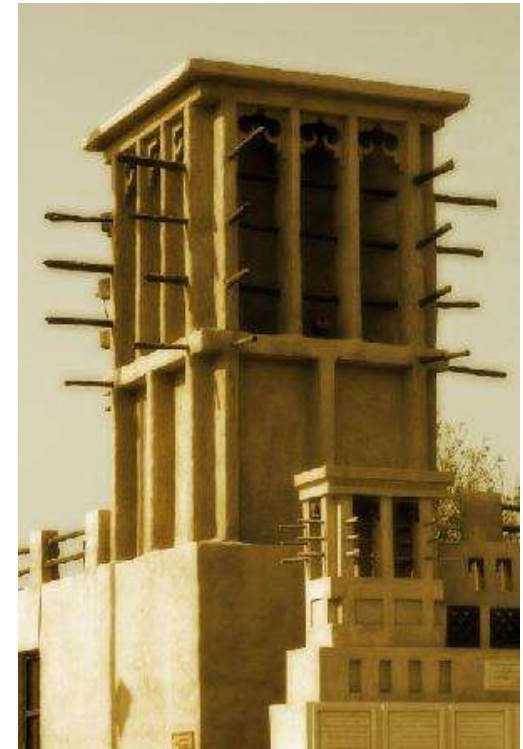



# What is a Wind Tower?

The wind tower is divided by partitions to create different shafts. One of the shafts functions as inlet to supply the wind and the other shafts works as outlet to extract the warm and stale air out. The temperature difference between the micro and macro climate creates different pressures and result in air currents

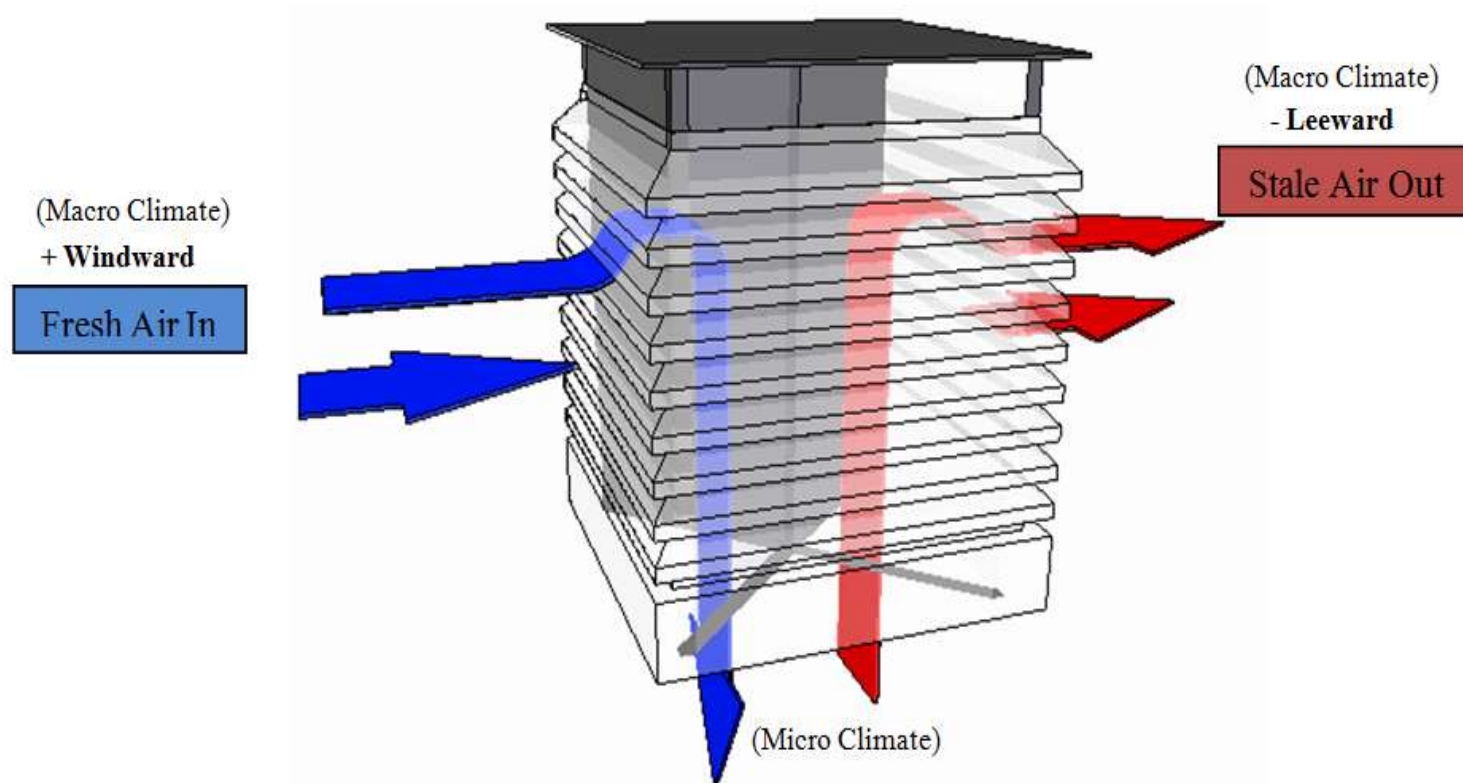





# Traditional Wind Towers

Naturally ventilated buildings do not require additional energy to move the airflow within a structure. However, the cooling capabilities of conventional wind towers which depend on the structure design itself are limited.

Commercial wind tower systems as a top-down roof mounted, multi directional device used for naturally ventilating buildings further enhances the portability of the device in comparison to its traditional counterpart.



# Commercial Wind Towers



UNIVERSITY OF LEEDS

Modern wind towers are usually compact and smaller in size compared to the traditional wind towers.



# Development of Wind Towers



UNIVERSITY OF LEEDS

Commercial wind towers have been used in the UK for the last 30 years, the four factors which apply to ANV building also apply to wind tower systems, detailed here is the development of the system to overcome these challenges and hence provide a viable alternative to HVAC systems.

The work carried has been undertaken using CFD Modeling, Wind tunnel testing and full scale far field testing. Moreover external building specialists BRE and BSRIA have also conducted independent assessments of the system.

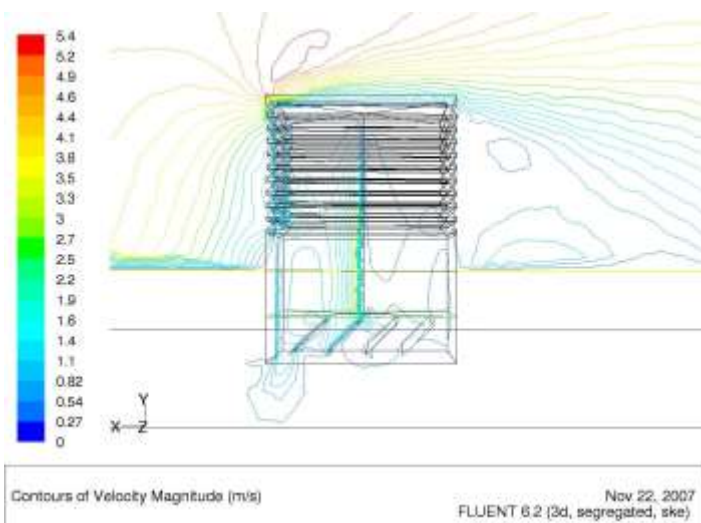

# Legislative requirements



**Table 1**  
CFD vs. BS5952:1991 recommendations concurrent flow

External wind velocity (m/s)	BS5952:1991 (L/s/m <sup>2</sup> )	CFD (L/s/m <sup>2</sup> )	BS5952:1991 (L/s per occupant)	CFD (L/s per occupant)
1	0.8	2.20	5	4.07
2	0.8	5.56	5	10
3	0.8	9.15	5	16.47
4	0.8	12.41	5	22.33
4.5	0.8	13.95	5	25.11
5	0.8	16.68	5	30.03

**Table 2**  
CFD vs. BS5959:1991 recommendations counter current flow

External wind Velocity (m/s)	BS5952:1991 (L/s/m <sup>2</sup> )	CFD (L/s/m <sup>2</sup> )	BS5952:1991 (L/s per occupant)	CFD (L/s per occupant)
1	0.8	2.39	5	4.29
2	0.8	5.85	5	10.53
3	0.8	9.37	5	16.86
4	0.8	12.99	5	23.38
4.5	0.8	15.04	5	27.06
5	0.8	18.06	5	32.51

BS5975 stipulates minimum ventilation rates based on occupancy data (if available) or floor area.

We have been able to prove that wind towers require minimal external airflow (1 m/s) to meet these requirements, with the UK average being 4.5 m/s.

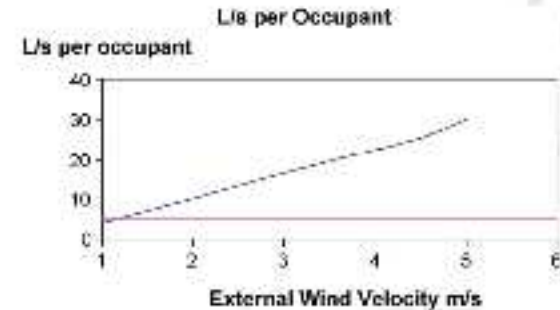

Fig. 17. Concurrent flow.

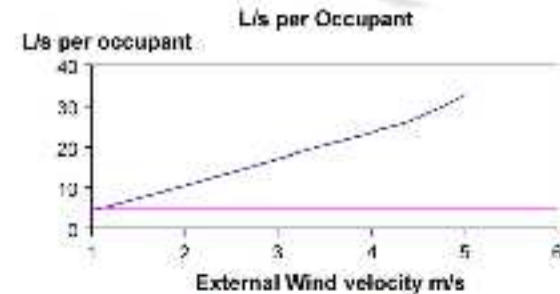

Fig. 18. Counter current flow.



# What if there's no external wind?

The wind tower does not rely solely on external wind, as the device is open to atmosphere it allows the warm air trapped at the ceiling height to escape, and thus draws in a fresh replacement supply using a siphon effect, therefore even if no external air was present we can fall back on natural buoyancy.

“It should be noted that during the buoyancy simulations the effect of introducing a window increased the internal velocities by 47%, however the effect of introducing the wind driven force increased the internal velocity by 76%. Thus the effect of introducing a window to increase buoyancy is comparable to the wind driven force.”

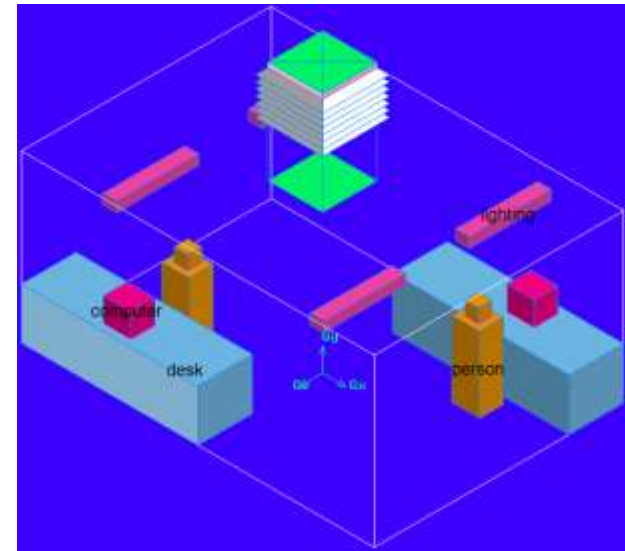



# Solar driven wind tower

The fact that we require such low air velocities to meet legislative requirements allows us to use low powered supplementary fans to aid air circulation in dense urban environments, the low power of the fan allows for a solar driven arrangement.

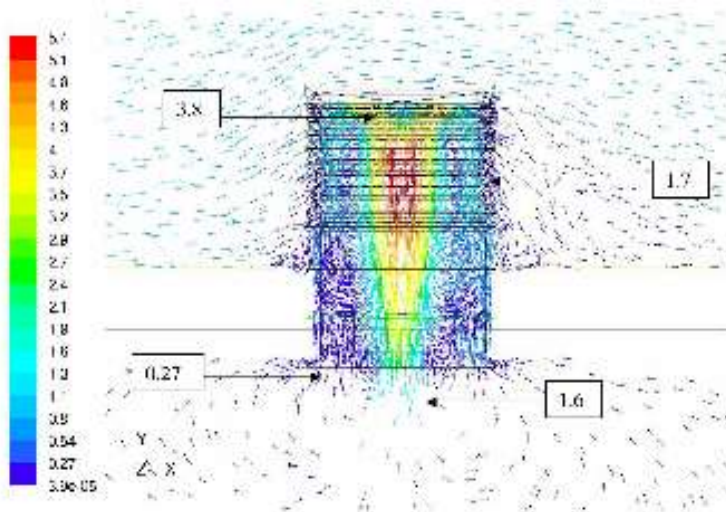

From the results, it was clear that a low-voltage fan would need to produce a minimum pressure of 20 Pa to achieve the BS required minimum ventilation rates. The fan should be located in the top position to ensure fresh air is drawn in at low external wind speeds (1 m/s) and delivered to the receiving room without restricting the exhaust air flow path.



The Windvent performed as expected in terms of pressure drop and velocity when the dampers angle was increased. The combined effects of pressure and velocity showed an optimum operating range of between 45 - 55 degrees.

The optimum operating range should be central to the operating strategy for the windvent as a single unit. However in order to obtain efficient usage of the windvent system the strategy must take into account the external wind velocities. Therefore when locating the size and amount of Windvents (multiple units may be used to supply large areas) a combined approach of macro to micro climate performance and control strategy should be employed.

Adding control dampers to the wind tower induces a pressure drop which creates an airflow obstruction, in natural ventilation this creates severe difficulties.

We have managed to obtain an optimum operating range for the dampers to allow air to flow freely and thus the size of the tower should be designed with this in mind.

# Full scale testing



UNIVERSITY OF LEEDS





# Validation



UNIVERSITY OF LEEDS

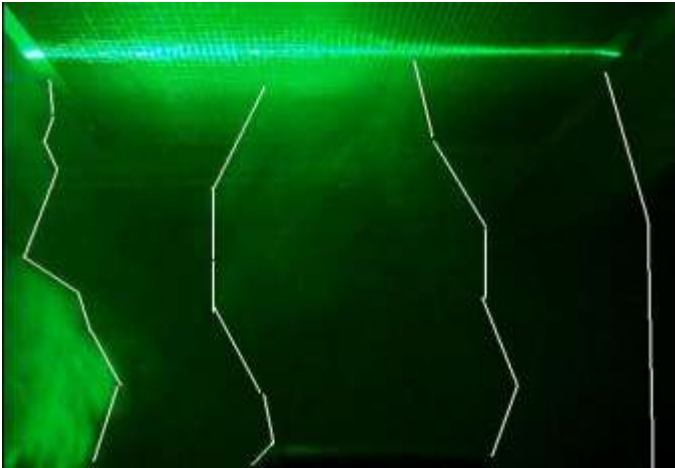

**Benchmark geometry comparison with an external velocity of 4m/s**

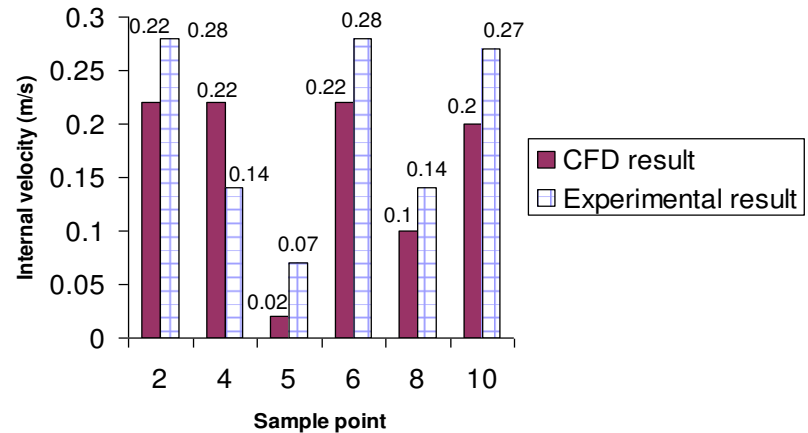

**Comparison of Elmualim simulation and experimental work**

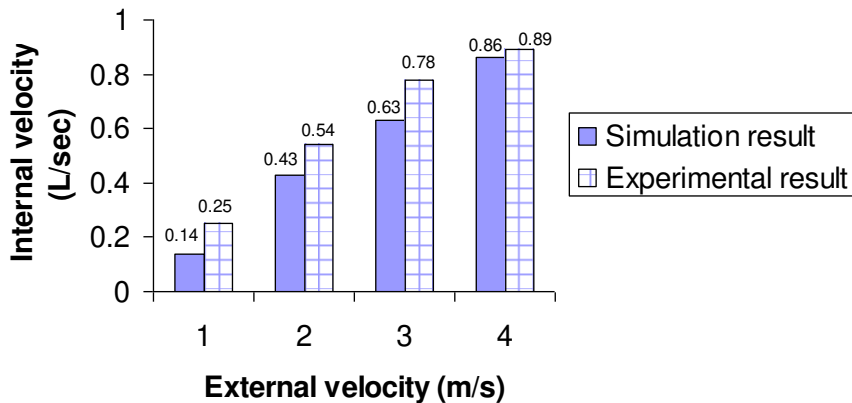

With the work fully validated I obtained UK patents and commercialised the products:

GB 0809311.4 Windvent louver angle

GB 0902600.6 Windvent louver distance

Products licensed to Midtherm Engineering Ltd Birmingham. ([www.naturallydriven.co.uk](http://www.naturallydriven.co.uk))



# Examples of the system in practice UNIVERSITY OF LEEDS



Windvent Ventilation system at Doncaster Academy



Orbis Energy



Leicester School building



# So where are we now?



UNIVERSITY OF LEEDS

Because we demand comfort – **WE ARE THE PROBLEM!**

Because we need good air quality to maintain health – **We can meet ventilation rate legislation**

Because its reliable – **We can achieve reliable airflow regardless of location and external wind speed**

Because we can control it - **We can use control dampers linked to existing BMS systems**

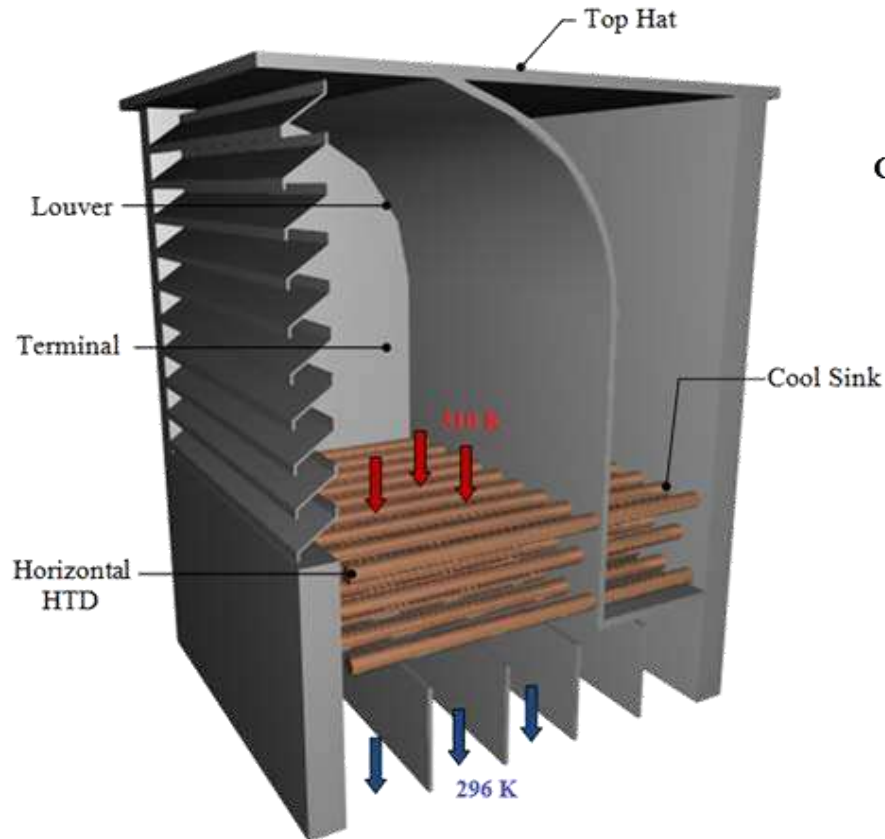

Wind tower with integrated heat pipe heat exchanger

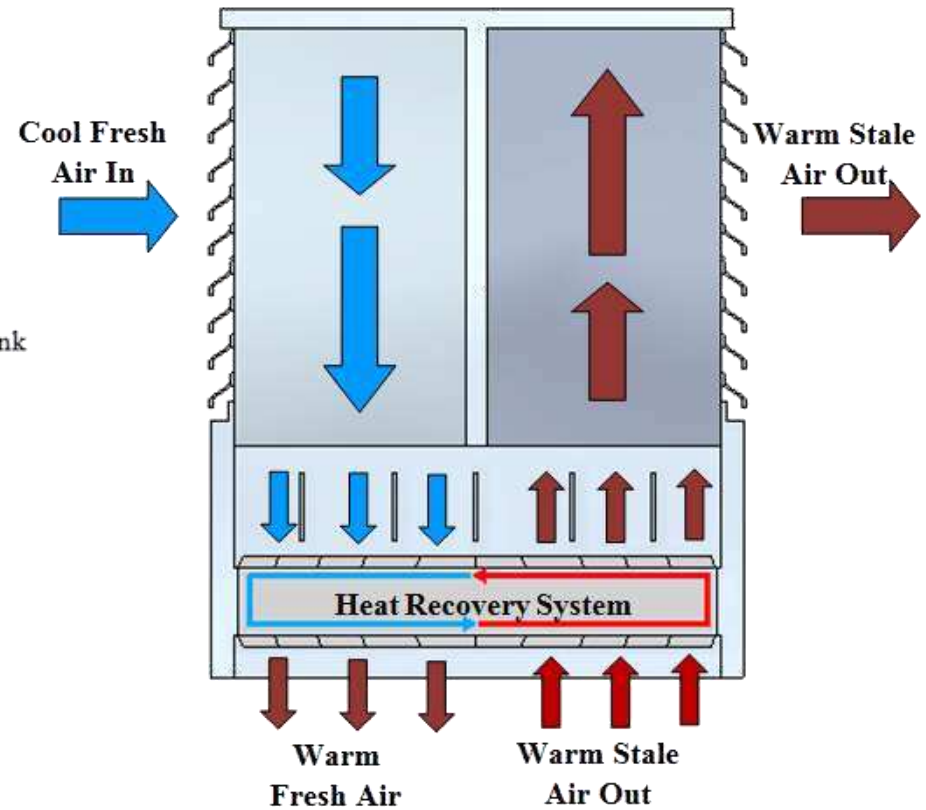

Wind tower with integrated heat recovery system

# Ventilative Cooling



UNIVERSITY OF LEEDS

**Integration of Passive Ventilation and Novel Cooling Systems for Reducing Air Conditioning Loads in Buildings** Qatar National Research Fund 3<sup>rd</sup> Cycle, NPRP 09-138-2-059, \$1,044,938, 2011-2014

In Qatar 60% of domestic energy consumption, this project takes the existing commercial wind tower and integrates a heat pipe arrangement to provide pre-cooled natural airflow into the building.

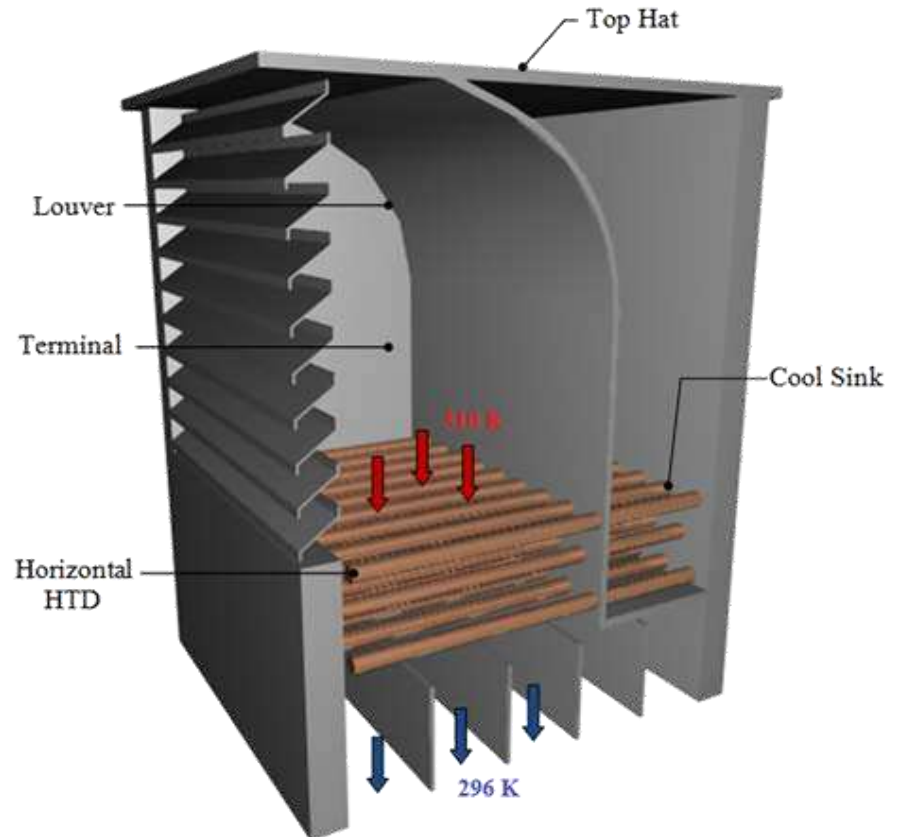



# Review: Building Cooling

The external power consumption of a desiccant cooling system is more than 60% when compared with other building cooling technologies.

A wind tower can be classified as a carbon-neutral passive cooling device unlike the rest since the electricity consumption is virtually 0% when in comparison with other cooling strategies.

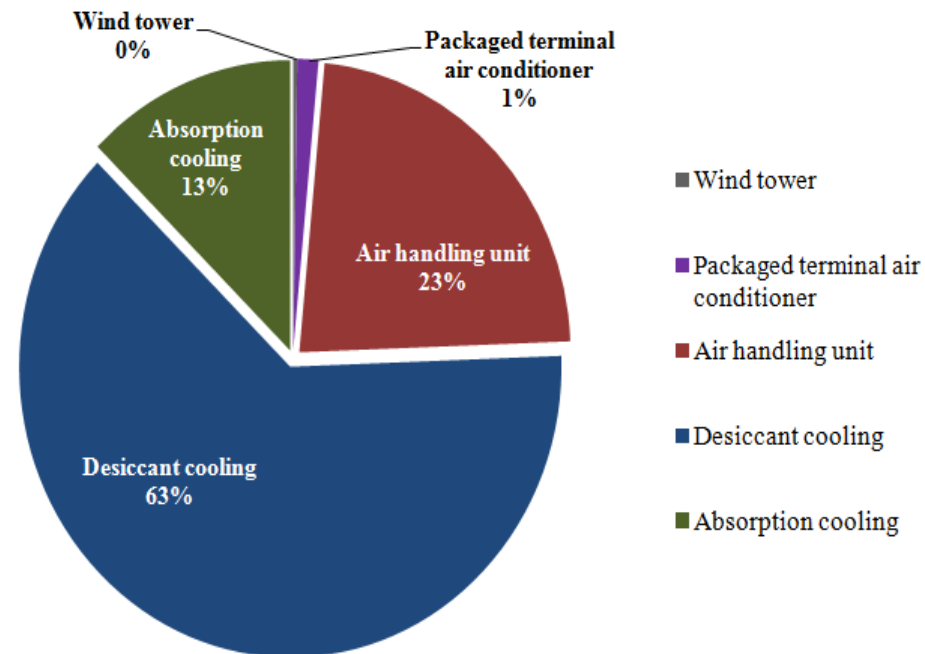
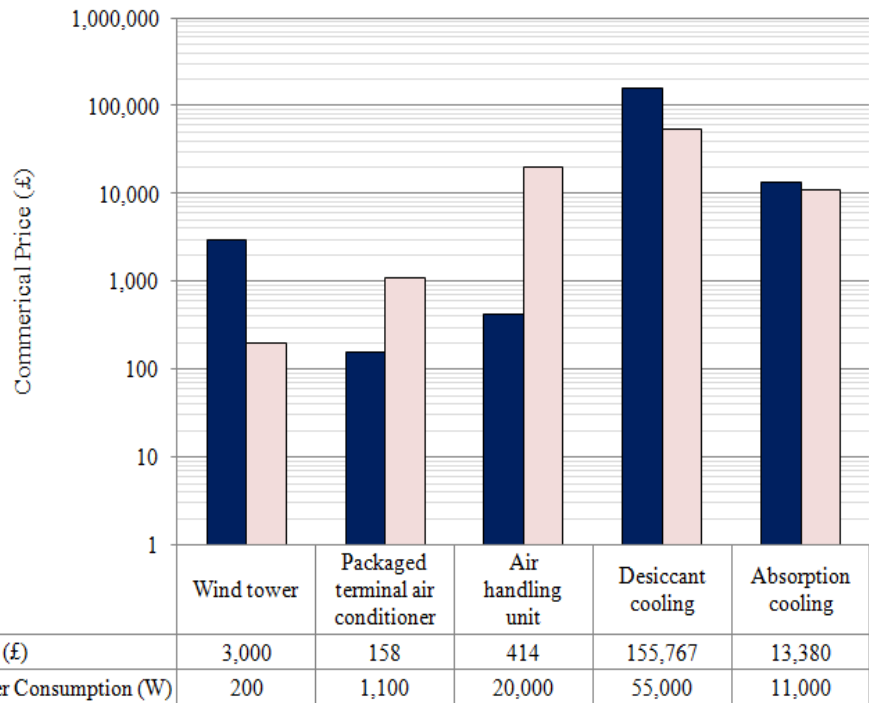



# Numerical Results: Temperature

Air temperature reduction is observed inside the microclimate, average temperature of 295.8 is obtained inside the models with the outdoor temperatures set at 310K.

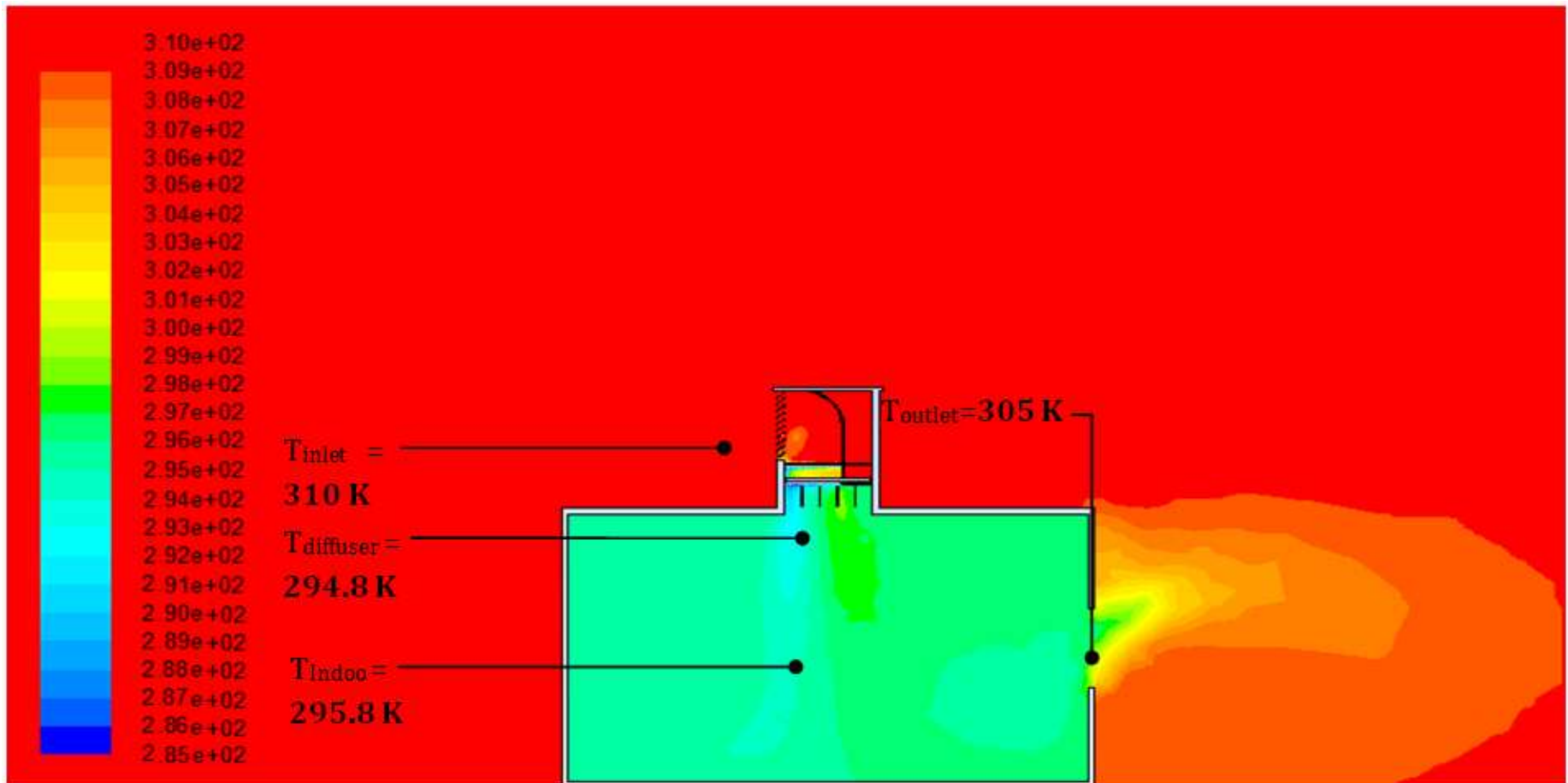



# Numerical Results: Airflow

The airflow splits at the wind ward side of the structure with the air entering the wind tower openings and the remaining flow shearing across the structure and exiting to right side of the enclosure

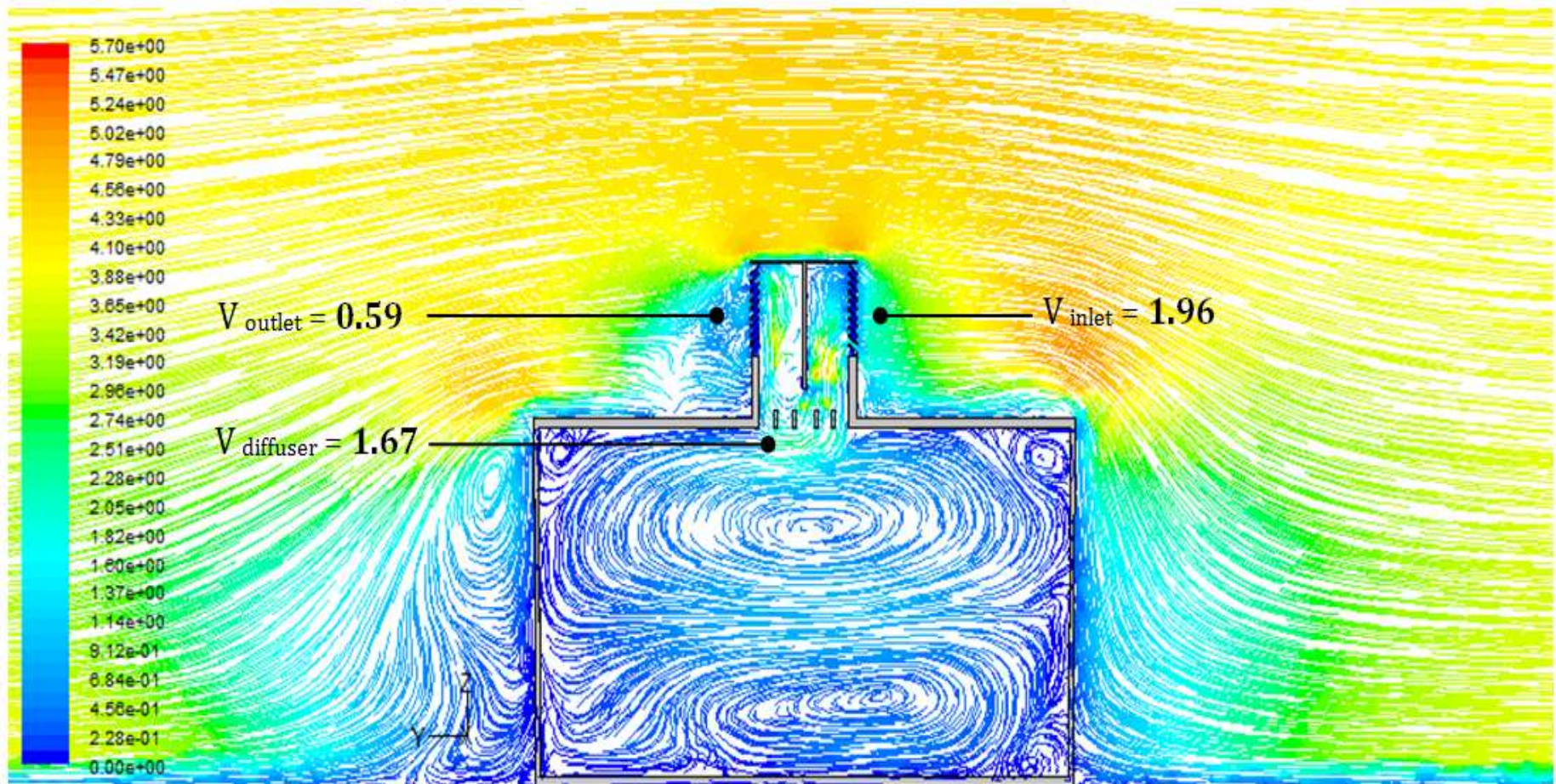





# Numerical Results: Optimisation

A horizontal plane constructed at immediate downstream of the horizontal heat pipes within the wind tower structure to analyse the air temperature differential and an air temperature reduction of 14K from the source temperature of 315K.

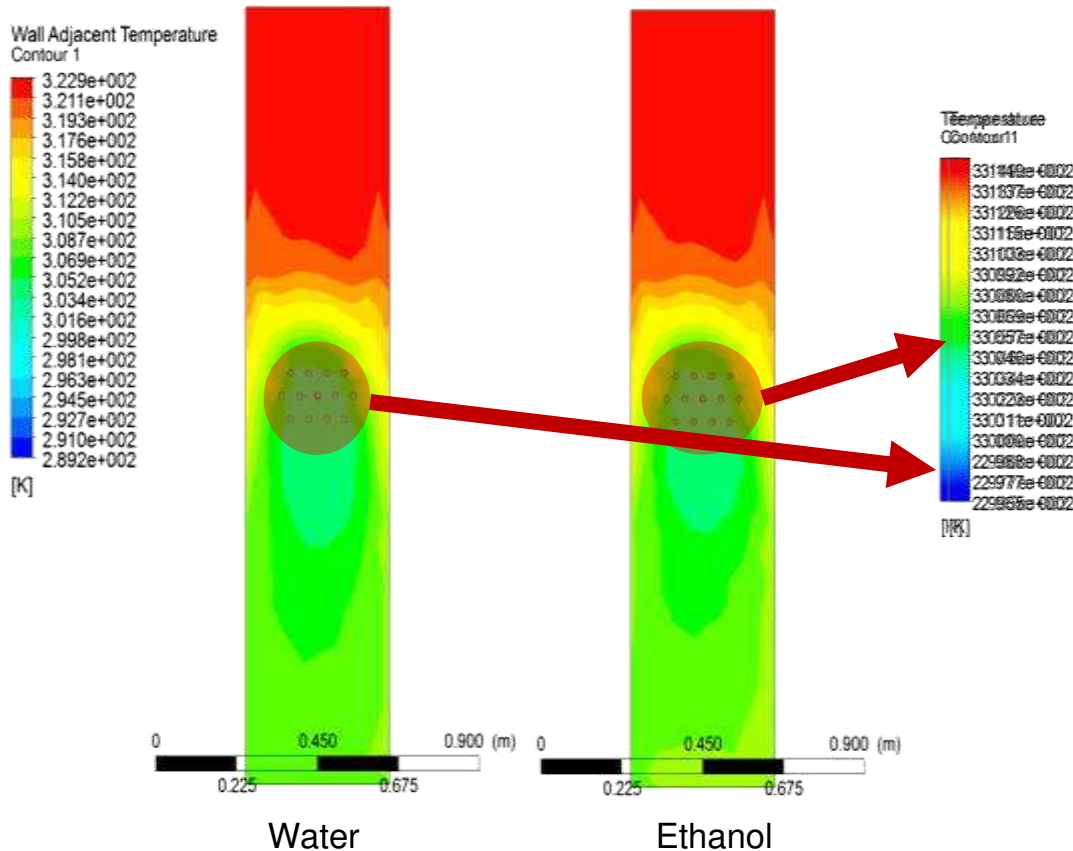

Temperature drop of **8.5K**

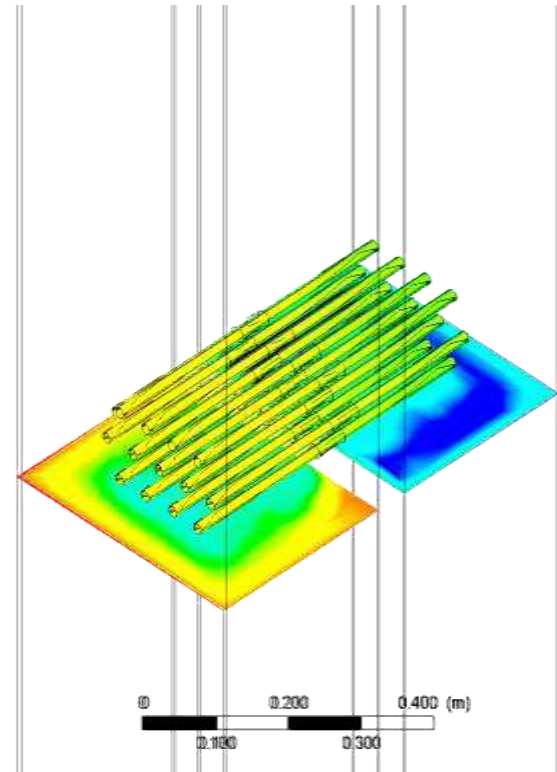

# Ventilative Heating



UNIVERSITY OF LEEDS

In the UK and Europe the external wind temperature creates a thermal comfort issue for the occupants, as the wind tower uses the buoyancy effect to induce airflow this work uses the same buoyancy effect to recover the exhaust heat and use as a pre-heater for the incoming air stream.

Coupling the heat exchanger to the control damper system creates airflow obstruction which must be overcome. In addition using rejected air as a pre heater effectively dilutes the replenished air, thus the ventilation requirements increase.

This work is currently under development using EPSRC funding.

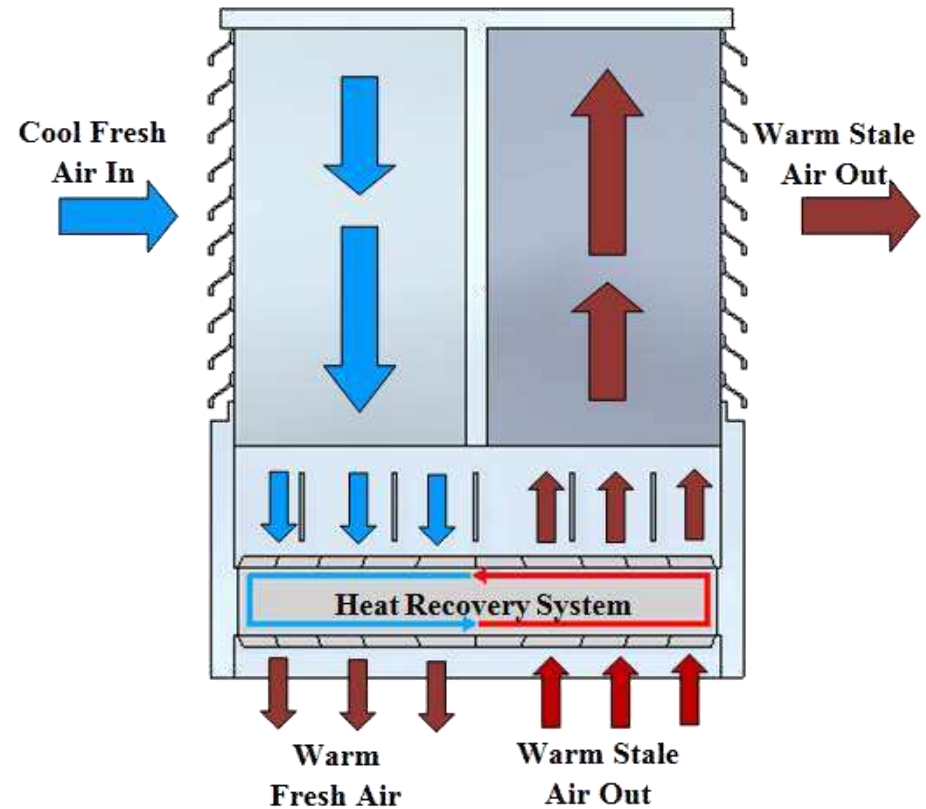

Chaudhry, HN; Hughes, BR; Ghani, SA *A review of heat pipe systems for heat recovery and renewable energy applications. RENEWABLE & SUSTAINABLE ENERGY REVIEWS, vol. 16, pp.2249-2259. 2012.*

Hughes, BR; Calautit, JK; Ghani, SA *The development of commercial wind towers for natural ventilation: A review. Applied Energy, vol. 92, pp.606-627. 2012.*

Hughes, BR; Chaudhry, HN; Ghani, SA *A review of sustainable cooling technologies in buildings. RENEW SUST ENERG REV, vol. 15, pp.3112-3120. 2011.*

Hughes, BR; Ghani, S *A Numerical Investigation Into The Feasibility Of A Passive-Assisted Natural Ventilation Device. International Journal Of Sustainable Energy, vol. 30, pp.193-2011. 2011.*

Hughes, BR; Mak, CM *A study of wind and buoyancy driven flows through commercial wind towers. ENERG BUILDINGS, vol. 43, pp.1784-1791. 2011.*

Hughes, BR; Ghani, SAAA *A numerical investigation into the effect of Windvent louvre external angle on passive stack ventilation performance. Building and Environment, vol. 45, pp.1025-1036. 2010.*

Hughes, BR; Ghani, SAAA *A numerical investigation into the effect of windvent dampers on operating conditions. Building and Environment, vol. 44, pp.237-248. 2009.*

Hughes, BR; Ghani, SAAA *Investigation of a windvent passive ventilation device against current fresh air supply recommendations. ENERG BUILDINGS, vol. 40, pp.1651-1659. 2008.*

Calautit, JK; Hughes, BR; Ghani, SA *A numerical investigation into the feasibility of integrating green building technologies into row houses in the Middle East. Architectural Science Review, vol. Volume 55 .*

Hughes, BR *An Engineering Design Analysis of a Wind Towers in: Romano VA, Duval AS (ed.) Ventilation: Types, Standards, and Problems. 2011.*