

This is a repository copy of *A simulation-optimization approach for integrating physical and financial flows in a supply chain under economic uncertainty*.

White Rose Research Online URL for this paper:

<https://eprints.whiterose.ac.uk/197150/>

Version: Published Version

Article:

Badakhshan, Ehsan and Ball, Peter David orcid.org/0000-0002-1256-9339 (2023) A simulation-optimization approach for integrating physical and financial flows in a supply chain under economic uncertainty. *Operations Research Perspectives*. 100270. ISSN 2214-7160

<https://doi.org/10.1016/j.orp.2023.100270>

Reuse

This article is distributed under the terms of the Creative Commons Attribution (CC BY) licence. This licence allows you to distribute, remix, tweak, and build upon the work, even commercially, as long as you credit the authors for the original work. More information and the full terms of the licence here:

<https://creativecommons.org/licenses/>

Takedown

If you consider content in White Rose Research Online to be in breach of UK law, please notify us by emailing eprints@whiterose.ac.uk including the URL of the record and the reason for the withdrawal request.

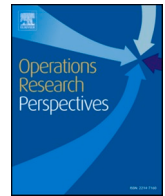

A simulation-optimization approach for integrating physical and financial flows in a supply chain under economic uncertainty

Ehsan Badakhshan^{a,*}, Peter Ball^b

^a Department of Finance Accounting and Business Systems, Sheffield Hallam University, Sheffield, S1 1WB, UK

^b School for Business and Society, University of York, York, YO10 5ZF, UK

ARTICLE INFO

Keywords:

System dynamics (SD)
Simulation-optimization (S-O)
Economic value added (EVA)
Asset-liability management
Cash flow management

ABSTRACT

In the last decade, increasing costs and organizational concerns regarding the funding and allocation of financial resources have led to significant attention being given to financial flow and its effects on planning decisions throughout supply chain networks. This study aims to develop a simulation-optimization model to integrate the financial and physical flows in a supply chain planning problem under economic uncertainty. The simulation-optimization model includes a mixed-integer linear programming model and a simulation-based optimization model that are connected through an iterative process. The economic value added (EVA) index is used to measure the financial performance of the supply chain. This study extends the literature on two research domains namely supply chain planning and finance and simulation-optimization modelling for supply chain management. The proposed model applies a scenario approach to cope with economic uncertainty in the supply chain. To demonstrate the efficiency of the proposed model, the performance of the proposed model in solving a test problem from the recent literature is compared with the performance of a conventional simulation-based optimization and mixed-integer linear programming approaches. The results of the study show a minimum of 6% improvement in the EVA obtained from the proposed simulation-optimization model compared to the EVA obtained from the simulation-based optimization model in all the studied scenarios. Moreover, the standard deviation of the EVA obtained from the proposed simulation-optimization model is at least 69% lower than the EVA obtained from the mixed integer programming model in all the studied scenarios. This shows that the proposed simulation-optimisation approach is more robust to economic uncertainty than the mixed-integer linear programming approach.

1. Introduction

The efficient management of the supply chain (SC) is not a tool which only helps organizations to gain a competitive edge but is a requirement that allows them to survive in a highly competitive business environment. SC management (SCM) connects the participants involved in a value chain of a product or service through modelling the physical, financial, and information flows across the chain. An SC system can be a complex system as it encompasses autonomous entities (i.e. suppliers, manufacturers, retailers), the processes in a value chain of a product or service such as procurement, production, distribution, and the uncertainties which might be internal such as uncertainty in the distribution lead time or external such as uncertainty in the end customers' demands [1]. Various planning decisions need to be made to manage this complex system [2].

All these planning decisions are impacted by financial resource allocation. That is to say, implementing planning decisions relies on the availability of financial resources [3]. For instance, a new facility in a SC cannot be opened unless the funding mechanism is explicit. Moreover, optimising planning decisions may save financial resources. For example, optimizing inventory decisions leads to savings in financial resources which in turn can provide the required resources for implementing other planning decisions such as production capacity expansion. Therefore, Incorporating the financial aspect of SCM in SC planning models ensures the availability of financial resources for implementing planning decisions and also provides opportunities on saving financial resources [4,5].

The financial aspect of SCM is incorporated in SC planning models in two ways: (1) considering costs associated with SC activities such as production and inventory holding and deducting these costs from SC

* Corresponding author.

E-mail addresses: e.badakhshan@shu.ac.uk (E. Badakhshan), Peter.Ball@york.ac.uk (P. Ball).

<https://doi.org/10.1016/j.orp.2023.100270>

Received 14 November 2022; Received in revised form 7 February 2023; Accepted 7 February 2023

Available online 18 February 2023

2214-7160/© 2023 The Author(s). Published by Elsevier Ltd. This is an open access article under the CC BY license (<http://creativecommons.org/licenses/by/4.0/>).

revenue to measure SC profitability; (2) considering the flow of cash which moves from the customers who are the only source of money in an SC to other SC members (i.e., retailers, distributors, suppliers). The smooth flow of cash within an SC enables SC members to meet their operations expenses and also invest the excess cash, inflow minus the required, for a return. The challenge faced by the SC members is to decide on the level of cash to be held for operations expenses as they strive to make a trade-off between adequacy of cash for meeting operations expenses and minimizing the opportunity cost which is incurred as a result of holding cash.

Literature on SCM merely considers the costs associated with SC activities and ignores the flow of cash within SCs [6,7]. Recently more attention has been given to the study of the cash flow through SCs in addition to the cost of activities (e.g., [5,8–10]). These studies consider various sources of uncertainty. The most frequently considered source of uncertainty is demand uncertainty (e.g., [10–12]). However, there are limited studies that consider economic uncertainty which refers to uncertainties in microeconomic, macroeconomic, financial and market conditions. Economic uncertainty has a significant impact on both the profitability of SCs and the flow of cash within SCs. For instance, increasing short-term and long-term interest rates leads to the increased cost of debt for SC members and consequently reduced profitability of the SC. From a cash flow perspective, this increases the opportunity cost of holding cash by SC members and also reduces the availability of cash for SC members as the investors' willingness to invest in the stock market decreases. Therefore, considering the economic uncertainty in SC planning and finance models results in obtaining a more accurate indication of profit and cash flow dynamics within an SC. To measure the impact of economic uncertainty on SC profitability, we need to employ indicators which consider the cost of capital employed by a SC when calculating SC profitability. Economic value added (EVA) is a metric that deducts the cost of capital employed by a SC from its income to provide a more realistic representation of SC profitability. Moreover, studies in the literature have not considered cash holding cost as an element in SC total cost. Incorporating cash holding cost into the SC total cost enables us to minimise the opportunity cost of holding cash by minimizing the level of cash held by SC members.

To address the gaps in the literature, we develop a simulation-optimization framework that incorporates cash flow modelling and uncertainties in macroeconomic and microeconomic parameters in an SC planning problem. The developed model adds the cash holding cost to SC's total cost. The reason for choosing the simulation-optimization methodology is its ability to integrate the benefits of both simulation and optimization. Optimization models are capable of identifying the optimal SC decisions but incorporating complexities including nonlinear relationships, delays, and feedback loops that exist in cash and physical flows of the SCs significantly increases their computational cost. On the other hand, simulation models are powerful tools for modelling the SC complexities, however, they are not able to determine the optimal SC decisions. This makes simulation-optimization an effective tool for addressing complex SC problems [13,14].

The rest of the paper is organised as follows: the literature review is presented in Section 2. The problem description and the proposed simulation-optimization approach are described in Section 3. Section 4 elaborates the model formulation. Section 5 illustrates the applicability of the proposed model through a case study. Finally, conclusions and directions for future research are given in Section 6.

2. Literature review

Two major research domains that are relevant to this study are: SC planning and finance and simulation-optimization modelling for SC management. Therefore, the literature review is organized in line with these two major research domains. This study integrates these research strands to address an integrated SC physical and financial flows planning problem under microeconomic and macroeconomic uncertainties.

2.1. SC planning and finance

Several works incorporated financial flow modelling into the SC planning problem. Table 1 provides a summary of the SC planning and finance literature. There are two main gaps in the literature. Firstly, much of the literature has developed mixed integer linear programming (MILP) models that ignore nonlinearities, delays, and feedback loops that exist in the physical and financial flows of the SCs (e.g., [[15–19]]). Narahariseti et al. [16] developed a MILP model that considered budget constraints. Zhang et al. [19] presented a MILP model that aimed to minimize the cash conversion cycle in an SC. Ramezani et al. [17] developed a MILP model that aimed to identify the optimal financial decisions such as the optimal level of current and fixed assets in an SC. Simulation-optimization modelling which is an efficient tool for capturing the nonlinearities, delays, and feedback loops that exist in the physical and financial flows of the SCs, remains underrepresented in the literature [20–22]. Although Utama et al. [23] highlighted the efficiency of simulation-optimisation for addressing the integrated SC planning

Table 1
SC planning and finance literature.

Author(s)	Modelling Approach	Model Objectives	Uncertain Parameters
Melo et al. [15]	MILP	Min Total cost	–
Narahariseti et al. [16]	MILP	Max Net present value	–
Zhang et al. [19]	MILP	Min Total cost Min cash conversion cycle Max Service level	–
Puigjaner and Lainez [24]	Simulation-optimization	Min Environmental impact Max Change in Equity	Demand Price Interest rates
Longinidis and Georgiadis [12]	MILP	Max Economic value added (EVA)	Demand
Nickel et al. [25]	MILP	Max Total financial benefit	Demand Interest rates
Longinidis and Georgiadis [26]	Mixed integer non-linear programming (MINLP)	Max EVA Max the Altman's Z-score	Demand Interest rates Risk-free rate of interest Expected return of the market
Ramezani et al. [17]	MILP	Max Change in Equity	–
Cardoso et al. [11]	MILP	Max Net present value	Demand
Arani and Torabi [27]	MILP	Min financial risk Max Net present value	Demand
Yousefi and Pishvaei [5]	MILP	Max EVA	Exchange rate
de Matta [28]	Linear Programming (LP)	Max Total profit	Product cost Transfer price
Wang and Huang [29]	MILP	Max shareholder value	Demand Exchange rate
Albrecht and Steinrück [30]	MILP	Max Total profit	–
Razavian et al. [10]	MILP	Max Total profit	Demand
Wolff et al. [18]	MILP	Min Total cost	–
Kalantari et al. [31]	Goal programming	Min Total profit	–
This study	Simulation-optimization	Max EVA	Demand Interest rates Risk-free rate of interest Expected return of the market

problems. To fill this gap, we present a simulation-optimization model which incorporates SC dynamics including nonlinearities, delays, and feedback loops that exist in the physical and financial flows of the SCs. Applying simulation-optimization modelling results in identifying the optimal SC decisions in a more realistic environment as the simulation-optimization is an efficient approach for capturing SC dynamics.

Secondly, there is limited research that considers uncertainties in both microeconomic and macroeconomic parameters (e.g., [24–26]). Puigjaner and Laínez, [24] considered demand, price, and interest rate uncertainties. Nickel et al. [25] considered demand and interest rates uncertainties. Longinidis and Georgiadis [26] considered uncertainties in demand, interest rates, expected return of the market, and the risk-free rate of interest. de Matta [28] considered uncertainties in the product price and transfer price. To fill this gap, we consider the uncertainties in both microeconomic and macroeconomic parameters including demand, interest rates, expected return of the market, and the risk-free rate of interest.

Thirdly, to the best of our knowledge no study incorporates cash holding cost into SC total cost. This enables us to minimise the opportunity cost which is incurred as a result of holding cash by SC members. To fill this gap, we consider cash holding cost in SC total cost.

Fourthly, the previous studies consider price as an uncontrollable parameter. They are either consider price as a given parameter (e.g., [5,26,31]) or consider price as an uncertain parameter (e.g., [24,28]). In this study, we formulate price as a controllable parameter and identify its optimal value.

As it is shown in Table 1, this study makes four contributions to the literature on SC planning and finance: (1) It uses simulation-optimisation which is an under-represented modelling approach in the literature. Although its efficiency has been highlighted [23], (2) It considers the uncertainties in both microeconomic and macroeconomic parameters as opposed to much of the literature which consider either macroeconomic or microeconomic parameters, (3) It incorporates cash holding cost into SC total cost as opposed to previous studies which ignore this, and (4) formulate price as a controllable parameter and identifies its optimal value as opposed to literature which consider price as a given parameter or an uncertain parameter.

2.2. Simulation-optimization modelling for SC management

Simulation-optimization modelling refers to any combination of simulation and optimization approaches [32]. Shanthikumar and Sargent [33] classified simulation-optimization models into two main categories: (1) hybrid models in which simulation and optimization approaches are combined into one single model, and (2) hybrid modelling that includes constructing independent simulation and optimization models and then integrating the solution strategy through establishing a feedback structure. The hybrid models are further divided into simulation-based optimization and optimization-based simulation models. Simulation-based optimization (SBO) relates to incorporating optimization algorithms into simulation models to identify the optimal values for the decision parameters of the simulation model. The optimization-based simulation is concerned with the computation of the optimization model parameters using simulation or sampling of the optimization model scenarios using simulation [32,34].

A review of studies in simulation-optimization modelling for SC management has revealed two main gaps in the literature. Firstly, much of the literature applied discrete-event simulation (DES) as the simulation approach in simulation-optimization models (e.g., [35–42]). Ding et al. [38] incorporated a non-dominated sorting genetic algorithm (NSGA-II) into a DES model to address an integrated network design, distribution and inventory planning problem. Otamendi and Doncel [41] consolidated GA and DES to manage the trade-offs between total cost and service reliability in a gas transmission SC. Altazin et al. [43] integrated a MILP and a DES model to address a train rescheduling

problem in railway systems. Wery et al. [42] integrated a MILP model and a DES model to address a sales and operations planning problem in the softwood lumber industry. Chiadamrong and Piyathanavong [37] proposed a hybrid modelling framework in which a MILP model, a DES model and the OptQuest optimization toolbox were integrated to address an SC network design problem. Liu et al. [40] presented a hybrid modelling framework in which a multi-objective optimization model and a DES model were integrated to address a product design and service planning problem. System dynamics (SD) simulation that is more efficient than the DES in tactical and strategic decision making in SCs is underrepresented. To fill this gap, we use SD as the simulation technique in a simulation-optimisation model.

Secondly, SBO models solely optimize the performance of the simulation systems by identifying the optimal values for the decision parameters of the simulation models (e.g., [8,44–48]). Chu et al. [45] and Peirleitner et al. [48] developed SBO models to minimize the total cost of inventory systems by identifying the optimal values for the inventory decision parameters. Duggan [46] and Aslam and Ng [44] developed SBO models to minimize the bullwhip effect by identifying the optimal values for the inventory decision parameters. Linnéusson et al. [47] presented a hybrid model that integrated SD and DES simulation and an NSGA-II algorithm to determine the optimal maintenance decisions. Badakhshan et al. [8] minimized the cash flow bullwhip by identifying the optimal inventory and financial decision parameters. The performance of the simulation systems could be enhanced by identifying the optimal values for the decision variables of the simulation models such as the flow of products in the SC networks in addition to the decision parameters of the simulation models. Gillis et al. [49] presented a hybrid model which integrated SD and GA to optimise response strategies to epidemics. To this end, this paper presents a simulation-optimization framework which integrates an SBO model, including system dynamics and genetic algorithm, and an optimization model, MILP. The developed model framework optimizes production and distribution decision variables and inventory and financial decision parameters within the SD simulation model.

This study makes two main contributions to the literature on simulation-optimisation modelling for SC management: (1) It employs SD which is an under-represented simulation technique as opposed to much of the literature which used DES as the simulation technique. SD is more efficient than the DES in tactical and strategic decision making [50], (2) It determines the optimal values for both decision variables and decision parameters of a simulation model as opposed to the previous studies which only identify the optimal values for the decision parameters of a simulation model.

3. Problem description and modelling approach

The general structure of the studied SC is depicted in Fig. 1. The SC includes four stages: (1) suppliers, (2) production centre, (3) distribution centres, and (4) retailers. In the downstream direction, suppliers provide raw material to the production centre. The products are then manufactured in the production centre and shipped to the retailers via distribution centres. The retailers are responsible for meeting customers' demands, which are uncertain and fluctuate in line with the economic environment. In the upstream direction, customers pay for products purchased from the retailers. It is assumed that the distribution centres and retailers are owned by the production centre and consequently share a common profit.

In the studied SC system, one product and multiple periods are considered. The suppliers can fulfil the entire order of the production centre, while the capacities of other SC members are restricted. The production centre can secure long-term and short-term loans. In this study, a MILP-SBO model is developed to maximize the economic profitability of the studied SC by identifying the optimal values for the following decisions: (1) The amount of raw material to be purchased from suppliers, (2) The production rate at production centre, (3) The

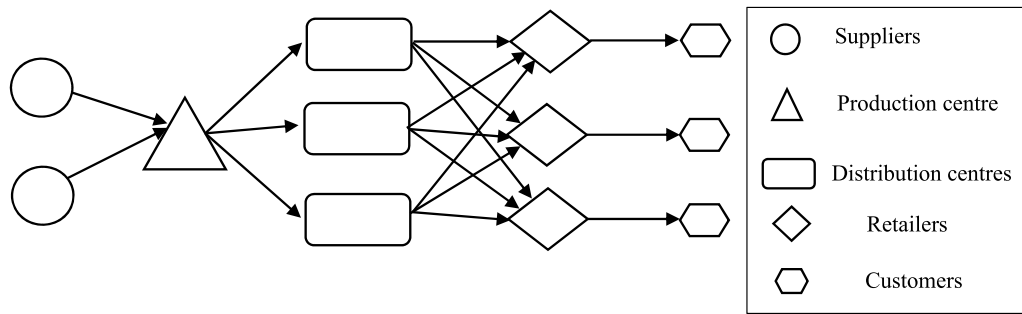

Fig. 1. The structure of the studied SC.

number of required suppliers and distribution centres, (4) The inventory levels at SC facilities, (5) The flow of products in the network, (6) The level of short-term and long-term liabilities, (7) The level of equity, (8) The level of fixed and current assets, (9) The level of cash, (10) Price of the product, (11) Profit distribution policy which denotes the dividends that is required to be paid to the shareholders.

The modelling approach consists of building independent MILP and SBO models and thereafter integrating these two models to identify the optimal decisions. The connection between the two models is illustrated in Fig. 2.

Firstly, by setting the initial price, desired cash, profit distribution policy, and desired inventories at the production centre, distribution centres, and retailers, the MILP model that aims to maximise the EVA is run to determine the structure of the SC including the open or close decision on distribution centres, select suppliers and the amount of raw material that should be purchased from each supplier. Moreover, the MILP model identifies the optimal values for the production rate at the production centre, inventory levels at SC members, the flow of products in the network, short-term and long-term liabilities, equity, fixed and current assets, and cash levels within the SC.

In step 2, the solution suggested by the MILP model determines the structure of the SC in the system dynamics (SD) simulation model. A simulation-based optimisation (SBO) framework which incorporates the genetic algorithm into the SD simulation model is then developed to

identify the optimal values for the price per tonne of the product, desired cash, profit distribution policy, and desired inventory levels at SC members. The procedure for the SBO framework is elaborated in Section 4.2. It is worth mentioning that formulating the price of the product as a variable within the MILP model converts the MILP model into a non-linear model which significantly increases the computational time. The stocking capacities of the SC facilities would be more realistic if obtained by the SBO model in which inventory dynamics is considered.

In step 3, the price, the profit distribution policy, the desired cash, and the desired inventories that are obtained from the SBO model are inputted into the MILP model in which the new optimal values to the decision variables explained in step 1 are determined. Taking the results of the second iteration from the MILP model, the SBO model is then run again to obtain a new solution containing the product price, the desired cash, the profit distribution policy and the desired inventories at the SC facilities (step 4).

At this point, the information gathered from the MILP-SBO model is used to examine whether the current solution, which is the EVA of the network is higher than the EVA obtained in the previous run of the MILP-SBO model. If the termination criterion is satisfied, the solution suggested by the MILP-SBO approach is accepted, otherwise, the results are used to revise the problem to be resolved by the MILP-SBO approach in the third iteration, and so on. The revision of the problem contains the revision of feasible intervals of the controllable parameters including

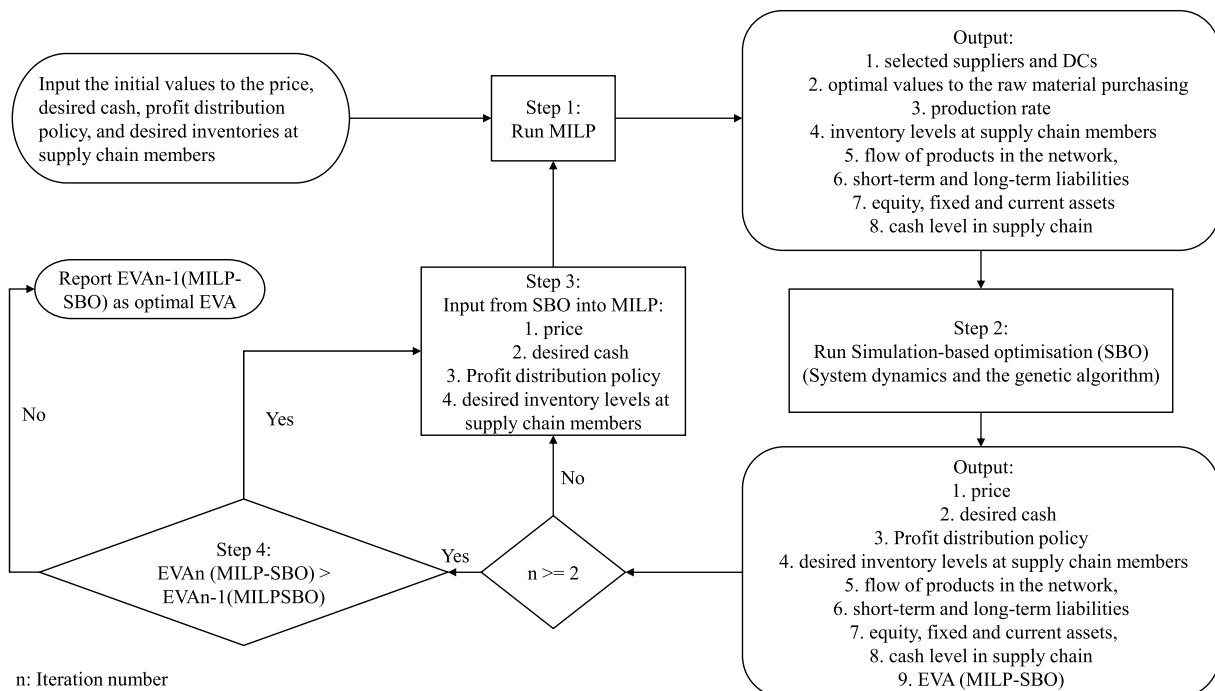

Fig. 2. The MILP-SBO modelling.

price, desired inventories at SC members, and desired cash.

4. Model formulation

4.1. Optimization model (MILP)

The optimization model (MILP) is presented as follows.

Indices

Indices	
r	Index of retailers $r = 1, 2, \dots, R$
d	Index of distribution centres $d = 1, 2, \dots, D$
s	Index of suppliers $s = 1, 2, \dots, S$
t	Index of period $t = 1, 2, \dots, T$

Physical parameters

Physical parameters	
o_t	Amount of raw material required for producing 1ton of product at the production centre during period t
d_{rt}	Demand placed to retailer r during period t
cap_{rm_t}	Storage capacity for raw material at production centre during period t
cap_t	Storage capacity for products at the production centre during period t
$cap_{d_{dt}}$	Storage capacity for products at distribution centre d during period t
cap_{r_t}	Storage capacity for products at retailer r during period t
$prcap_t$	Production capacity at the production centre during period t
$DIRM_t$	Desired inventory of the raw material at the production centre at the end of period t
PDI_t	Desired inventory of the products at the production centre at the end of period t
DDI_{dt}	Desired inventory of the products at distributor d at the end of period t
RDI_{rt}	Desired inventory of the products at retailer r at the end of period t

Financial parameters

Financial parameters	
r_f	Risk-free rate of interest during period t
r_m	Expected return of the stock market during period t
STR_t	Short-term interest rate during period t
LTR_t	Long-term interest rate during period t
tr_t	Tax rate during period t
pr_t	Price of product per ton during period t
upc_t	Unit production cost during period t
tc_{st}	Transportation cost from supplier s to the production centre during period t
tc_{cd}	Transportation cost from production centre to distributor centre d during period t
$tc_{d_{dr}}$	Transportation cost from distribution centre d to retailer r during period t
hr_t	Holding cost per ton of raw material at the production centre during period t
hp_t	Holding cost per ton of product at the production centre during period t
ho_{dt}	Holding cost per ton of product at distribution centre d during period t
hs_{rt}	Holding cost per ton of product at retailer r during period t
$fc_{d_{dt}}$	Fixed cost of distribution centre d during period t
fc_{p_t}	Fixed cost of production centre during period t
fc_{r_t}	Fixed cost of retailer r during period t
ucc_t	Holding cost per unit of cash during period t
rmc_{st}	Purchasing price of raw material from supplier s during period t
dr_t	Depreciation rate during period t
css_t	Share of NOPAT in the form of cash during period t
rmv_t	Value of raw material per ton during period t
PDP_t	Profit distribution policy during period t
DCS_t	Desired cash level at the end of period t
$DFAV_{dt}$	Distribution centre d fixed assets value at the end of period t
$PCFAV_t$	Production centre fixed assets value at the end of period t
$RFAV_{rt}$	Retailer r fixed assets value at the end of period t

Physical decision variables

Physical decision variables	
SR_{rt}	Sale rate of retailer r during period t
PR_t	Production rate during period t
X_{st}	Quantity of raw material purchased from supplier s during period t

(continued on next column)

(continued)

Y_{dt}	$= \begin{cases} 1 & \text{if distribution centre } d \text{ is open during period } t \\ 0 & \text{if distribution centre } d \text{ is closed during period } t \end{cases}$
Z_{st}	$= \begin{cases} 1 & \text{if supplier } s \text{ is active during period } t \\ 0 & \text{if supplier } s \text{ is not active during period } t \end{cases}$
SC_{dt}	Quantity of products shipped from production centre to distribution centre d during period t
SDI_{drt}	Quantity of products shipped from distribution centre d to retailer r during period t
FIR_t	Inventory level of the raw material at production centre at the end of period t
FIP_t	Inventory level of products at production centre at the end of period t
FIO_{dt}	Inventory level of products at distribution centre at the end of period t
FIS_t	Inventory level of products at retailer at the end of period t

Financial decision variables

Financial decision variables	
STL_t	Short-term liabilities at the end of period t
LTL_t	Long-term liabilities at the end of period t
E_t	Equity at the end of period t
CS_t	Cash level at the end of period t
FA_t	Fixed assets at the end of period t
CA_t	Current assets at the end of period t
DPR_t	Depreciation during period t
RA_t	Receivable accounts at the end of period t
INR_t	Inventory value at the end of period t
$NOPAT_t$	Net operating profit after tax during period t
NIS_t	New issued stocks during period t

4.1.1. Objective function

The economic profitability of the studied SC is measured by the economic value added (EVA) index. The EVA [51] is a widely used index which integrates financial and economic performance indicators. This indicator rectifies the optimistic interpretation of a company's performance by deducting the cost of employed capital from its net income. Economic situation has a significant impact on the cost of employed capital. Therefore, in presence of economic uncertainty it is critical to use EVA rather than profitability which ignores the cost of employed capital. The formulation of the EVA is given in Eq. (1), where NOPAT is the net operating profit after tax reported in the income statement and WACC is the weighted average cost of capital, a figure representing the real costs concerned with the sources of capital employed by the company [52].

$$EVA_t = \sum_{t=1}^T [NOPAT_t - (WACC_t)IC_t] \quad (1)$$

The WACC (2) is the return needed to compensate capital providers, i.e. creditors and stakeholders and is obtained by multiplying the cost of debt (CD) and cost of equity (CE) by their proportional weight and then taking the sum of the results. The cost of debt is the weighted average of short-term and long-term liabilities. The cost of equity is measured by the capital asset pricing model (CAPM) which contains three elements. The first element is the risk-free rate of interest (r_f) which is the reward for placing capital in a risk-free asset such as government bonds. The second element, the difference between the expected return of the stock market (r_m) and (r_f), is the reward for placing capital in an investment which requires taking risks such as stock market bonds. The third element, the risk measure (β) is the amount of systematic risk present in an asset. Invested capital (IC) (3) accumulates the amount of financing from debt and equity.

$$WACC_t = \left(\frac{E_t}{IC_t} (r_f + (r_m - r_f)\beta) \right) + \left(\frac{STL_t + LTL_t}{IC_t} \left(\frac{STL_t}{TL_t} STR_t + \frac{LTL_t}{TL_t} LTR_t \right) (1 - tr_t) \right) \quad (2)$$

$$IC_t = STL_t + LTL_t + E_t \quad \forall t. \tag{3}$$

To calculate the NOPAT (4), the earnings before interest and taxes (EBIT) is multiplied by 1 minus tax rate (tr). The EBIT which is the gross income of a company is calculated by subtracting the total cost (TC) from the net sales (NTS). The revenue of the SC (6) is obtained by multiplying the sale amounts of each retailer by the price and aggregating the results.

$$NOPAT_t = EBIT_t(1 - tr_t) \quad \forall t. \tag{4}$$

$$EBIT_t = NTS_t - TC_t \quad \forall t. \tag{5}$$

$$NTS_t = \sum_{r=1}^R SR_{rt}pr_t \quad \forall t. \tag{6}$$

The total cost (7) of the chain contains the production cost at the production centre (PC), the transportation cost between centres (TRC), the inventory holding cost at the centres (HC), fixed costs of the centres (FC), cash holding cost (CC), and the cost of raw material purchased from the suppliers (RMC). Eq. (8) shows the operating cost at the production centre which is obtained via multiplying production rate (PR) and unit production cost (upc). The operating costs are the costs associated with the required activities to produce final products. The transportation cost (TRC)(9) includes the transportation cost from the supplier to the manufacturer (tc), the manufacturer to the distributor (tcc), and the distributor to the retailer (tcd). Eq. (10) represents the inventory holding cost incurred by the manufacturer, distribution centres, and retailers. This cost encompasses the holding cost of the raw material (hr) and the holding cost of the product (hp) at the production centre, in addition to the holding cost of safety stock at the distribution centres and retailers. The unit holding cost of raw material is set to 10% of the raw material price. The unit holding costs of the product at production centre (hp), distribution centres (ho), and retailers (hs) are set to 10% of the product price.

$$TC_t = PC_t + TRC_t + HC_t + FC_t + CC_t + RMC_t + DPR_t \quad \forall t. \tag{7}$$

$$PC_t = upc_t PR_t \quad \forall t. \tag{8}$$

$$TRC_t = \sum_{s=1}^S tc_{st} X_{st} + \sum_{d=1}^D tcc_{dt} SC_{dt} + \sum_{r=1}^R \sum_{d=1}^D tcd_{drt} SDI_{drt} \quad \forall t. \tag{9}$$

$$HC_t = hr_t \left(\frac{FIR_t + FIR_{t-1}}{2} \right) + hp_t \left(\frac{FIP_t + FIP_{t-1}}{2} \right) + \sum_{d=1}^D ho_{dt} \left(\frac{FIO_{dt} + FIO_{dt-1}}{2} \right) + \sum_{r=1}^R hs_{rt} \left(\frac{FIS_t + FIS_{t-1}}{2} \right) \quad \forall t. \tag{10}$$

The fixed cost (11) contains all the expenses incurred by an SC member such as employee salaries, and these do not depend on the number of goods and services provided by the member. This cost is obtained for the distribution centres by multiplying the fixed cost (fcd) by a binary variable that indicates the activity of the distribution centre. The fixed costs of the production centre (fcp) and retailers (fcr) are not multiplied by the binary variable as it is assumed they are situated fixed in locations. Companies hold cash to pay their suppliers for their services and also cover unexpected expenses which may arise. Cash holding cost (12) is the opportunity cost of choosing to hold cash rather than investing in more profitable options such as purchasing stock. This cost in each period is calculated by multiplying unit cash cost (ucc) by the average amount of cash during the period. The raw material cost (13) is the cost of purchasing raw material from different suppliers which is determined by multiplying the amount purchased (X) by the price of each unit (rmc). Depreciation (DPR) is calculated in constraint (14) by

multiplying fixed assets value and depreciation rate (dr).

$$FC_t = \sum_{d=1}^D fcd_{dt} Y_{dt} + fcp_t + \sum_{r=1}^R fcr_{rt} \quad \forall t. \tag{11}$$

$$CC_t = ucc_t \left(\frac{CS_t + CS_{t-1}}{2} \right) \quad \forall t. \tag{12}$$

$$RMC_t = \sum_{s=1}^S X_{st} rmc_{st} \quad \forall t. \tag{13}$$

$$DPR_t = dr_t FA_t \quad \forall t. \tag{14}$$

4.1.2. Constraints

In this section, the constraints of the model which were categorised into physical flow constraints and financial flow constraints are presented.

4.1.2.1. *Physical flow constraints.* Constraint (15) shows the inventory level of raw material held in the production centre at each period is equal to the inventory left at the end of the previous period plus the amount of the purchased material from the suppliers minus the amount consumed for producing the final products. The available inventory of products held in the production centre at the end of period t (16) equals the inventory held at the end of period $t - 1$ plus production rate during the period, minus products transported from the plant to distribution centres during the same period.

$$FIR_t = \sum_{s=1}^S X_{st} - PR_t o_t + FIR_{t-1} \quad \forall t. \tag{15}$$

$$FIP_t = PR_t - \sum_{d=1}^D SC_{dt} + FIP_{t-1} \quad \forall t. \tag{16}$$

Constraints (17) and (18) state that the inventory level at each distributor and retailer is equal to the amount of product that flows into the member inventory from the upstream echelon plus the inventory that is left over from the previous time, minus the amount of product that flows out of the member to the downstream echelon.

$$FIO_{dt} = SC_{dt} - \sum_{r=1}^R SDI_{drt} + FIO_{dt-1} \quad \forall d, t. \tag{17}$$

$$FIS_{rt} = \sum_{d=1}^D SDI_{drt} - SR_{rt} + FIS_{rt-1} \quad \forall r, t. \tag{18}$$

Constraint (19) enforces the number of products shipped from each retailer to be less or equal to the end customer demand.

$$SR_{rt} \leq d_{rt} \quad \forall r, t. \tag{19}$$

Constraint (20) enforces the sum of products sold to end customers to be equal to the sum of the products sent to the retailers. Constraint (21) states that the sum of products shipped to the retailers should be equal to the products sent to the distribution centres.

$$SR_{rt} = \sum_{d=1}^D SDI_{drt} \quad \forall r, t. \tag{20}$$

$$\sum_{r=1}^R SDI_{drt} = SC_{dt} \quad \forall d, t. \tag{21}$$

Constraint (22) ensures that at least one of the suppliers is active at each period. Constraint (23) ensures that at least one of the distribution centres is open at each period.

$$\sum_{s=1}^S Z_{st} \geq 1 \quad \forall t. \tag{22}$$

$$\sum_{d=1}^D Y_{dt} \geq 1 \quad \forall t. \tag{23}$$

Constraints (24)-(27) state that the inventory levels at the production centre, distribution centres and retailers at any period must be greater than their specified safety stock levels known as the desired inventories (*DI*) which are determined by the SBO model.

$$DIRM_t \leq FIR_t \leq caprm_t \quad \forall t. \tag{24}$$

$$PDI_t \leq FIP_t \leq cap, \quad \forall t. \tag{25}$$

$$Y_{dt}DDI_{dt} \leq FIO_{dt} \leq Y_{dt}capd_{dt} \quad \forall t, d. \tag{26}$$

$$RDI_{rt} \leq FIS_{rt} \leq capr_{rt} \quad \forall t, r. \tag{27}$$

Constraint (28) controls the production rate of the production centre not to exceed the available production capacity and not to be lower than zero.

$$0 \leq PR_t \leq prcap_t \quad \forall t. \tag{28}$$

4.1.2.2. Financial flow constraints. Constraint (29) formulates the basic equation of the balance sheet. This equation illustrates the equality of the assets to equity (*E*) and debts. The assets comprises of fixed assets (*FA*) and current assets (*CA*) while the debts includes short-term liabilities (*STL*) and long-term liabilities (*LTL*).

$$FA_t + CA_t = E_t + STL_t + LTL_t \quad \forall t. \tag{29}$$

The fixed assets (*FA*) value (30) at the end of each period is determined by aggregating the fixed assets of the SC members and then deducting the depreciation.

$$FA_t = \sum_{d=1}^D DFAV_d Y_{dt} + PCFAV_t + \sum_{r=1}^R RFAV_{rt} - DPR_t \quad \forall t. \tag{30}$$

Constraint (31) formulates the current assets (*CA*) which is composed of cash (*CS*), receivable accounts (*RA*), and inventory value (*INR*).

$$CA_t = CS_t + RA_t + INR_t \quad \forall t. \tag{31}$$

Constraint (32) shows the amount of cash available which is obtained by aggregating the total amount of loans (*STL* + *LTL*), newly issued stocks, and the operating profit which is accessible in the form of cash. The portion of the operating profit that is not accessible in the form of cash is accumulated in the receivable accounts (*RA*) (33).

$$CS_t = css_t NOPAT_t + NIS_t + CS_{t-1} \quad \forall t. \tag{32}$$

$$RA_t = (1 - css_t) NOPAT_t + RA_{t-1} \quad \forall t. \tag{33}$$

Constraint (34) indicates the inventory value which is determined via multiplying the sales price of each member in their corresponding inventory and then taking the sum of the results.

$$INR_t = FIR_t rmv_t + \left(FIP_t + \sum_{d=1}^D FIO_{dt} Y_{dt} + \sum_{r=1}^R FIS_{rt} \right) pri \quad \forall t. \tag{34}$$

The equity value (*E*) at any period is calculated in constraint (35) by aggregating the accumulated equity from the previous period, net operating profit after tax (*NOPAT*) that is not distributed amongst shareholders and new stocks that are issued.

$$E_t = (1 - PDP_t) NOPAT_t + E_{t-1} + NIS_t \quad \forall t. \tag{35}$$

Constraint (36) ensures that the cash level at the end of each period is greater than the safety cash level known as desired cash level determined by the SBO model.

$$DCS_t \leq CS_t \quad \forall t. \tag{36}$$

4.2. Simulation-based optimization (SBO) model

The MILP model presented in the previous section ignores the dynamics of the physical and financial flows including nonlinearities, delays, and feedback loops that exist in the physical and financial flows. Considering these within the MILP model converts it into a non-linear model and increases its computational time significantly. To identify optimal values for the inventory and financial decision parameters in a more efficient way we present an SBO framework that integrates an SD simulation model and a Genetic algorithm (GA).

4.2.1. SD simulation model

The SD simulation model considers the dynamics of the physical and financial flows and therefore represents a more realistic view of these flows in the studied SC. Fig. 3 illustrates the stock and flow diagram for the physical flow. It considers the dynamics of the physical flow from three perspectives: (1) delays in physical flow including distribution lead time between raw material supplier and manufacturer, production lead time at the manufacturer, distribution lead time between manufacturer and distribution centre, and distribution lead times between distribution centre and retailers. All these parameters are set to 1 week; (2) feedback loops such as material inventory control loop that modifies the material order quantity in line with the material inventory. The higher the material inventory, the lower the material order quantity; (3) formulating non-linear relationships between the decision parameters and variables by incorporating decision parameters into their corresponding module. The decision parameters have been highlighted in Fig. 3. For instance, to calculate the raw material order, the gap between the desired and actual material inventory is divided by the material inventory adjustment time (*MIAT*). Inventory decision parameters for the retailers and the distributor including the desired inventory (*DI*), the desired supply line (*DSL*), the forecasting parameter for inventory adjustment (α), and the forecasting parameter for supply line adjustment (β) are added to their corresponding order quantity module. Production decision parameters including the minimum order processing time (*MOPT*), safety stock coverage (*SSC*), inventory adjustment time (*IAT*), manufacturing cycle time (*MCT*), and WIP adjustment time (*WIPAT*) are added to the production module. Material decision parameters including material safety stock coverage (*MSSC*), minimum material inventory coverage (*MMIC*), and material inventory adjustment time (*MIAT*) are incorporated into the material order quantity module.

Fig. 4 shows the stock and flow diagram for the financial flow. Similar to Fig. 3, It considers the delays and feedback loops in the financial flow. The delay in financial flow is payment lead time which is set to 4 weeks. It also formulates non-linear relationships between the decision parameters and variables by incorporating financial decision parameters into cash collection, cash payment, *NOPAT*, *WACCC*, and invested capital modules. These include unit production cost (*UPC*), collection policy (*m*), payment policy (*n*), desired cash (*DC*), profit distribution policy (*PDP*), new stock parameter (*NSP*), and sales price (*SP*). SD simulation model cannot identify the optimal values of the inventory and financial decision parameters as it is not an optimiser. To determine the optimal values of the inventory and financial decision parameters, SD simulation needs to be integrated with an optimiser, e.g., the Genetic Algorithm (GA). This is explained in Section 4.2.2.

The Appendix provides stock and flow diagrams of the physical and financial flows in which a detailed explanation of the non-linear relationships between the decision parameters and variables, delays and feedback loops that exist in the physical and financial flows are given. The definition of the inventory and financial decision parameters are also provided in the Appendix.

SD simulation models need to be validated through validation tests. Three validation tests including a model structure test, boundary

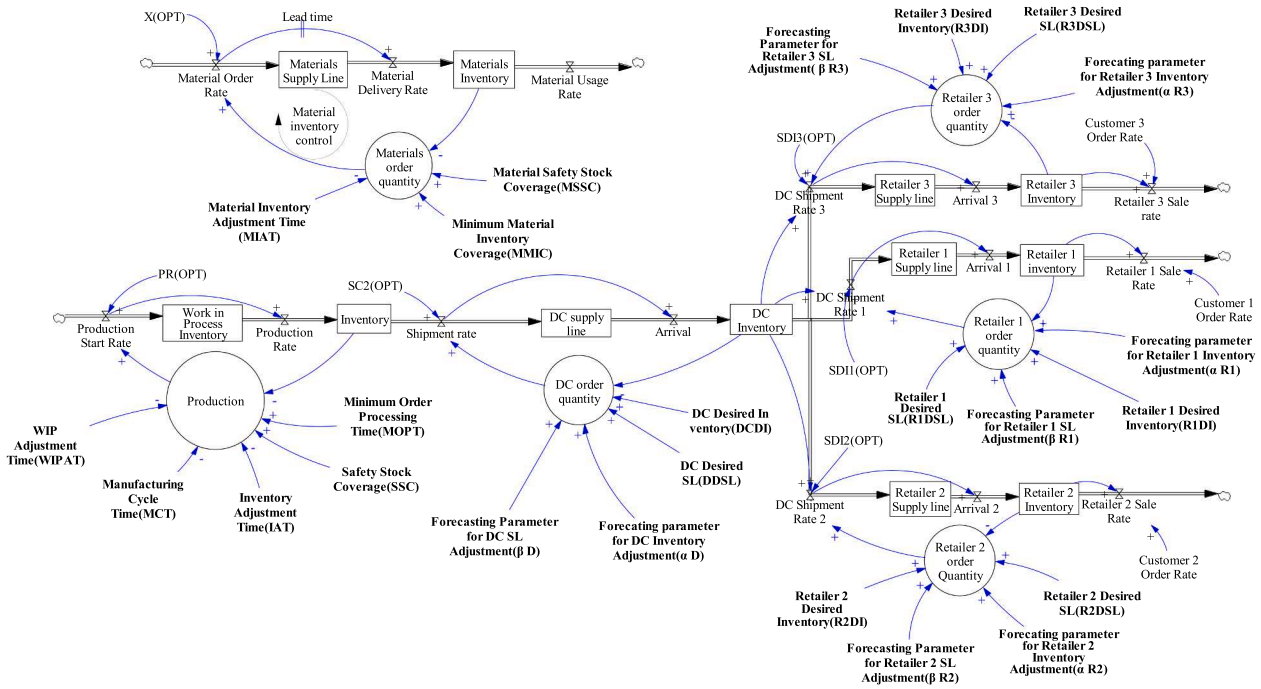

Fig. 3. Stock and flow diagram of physical flow.

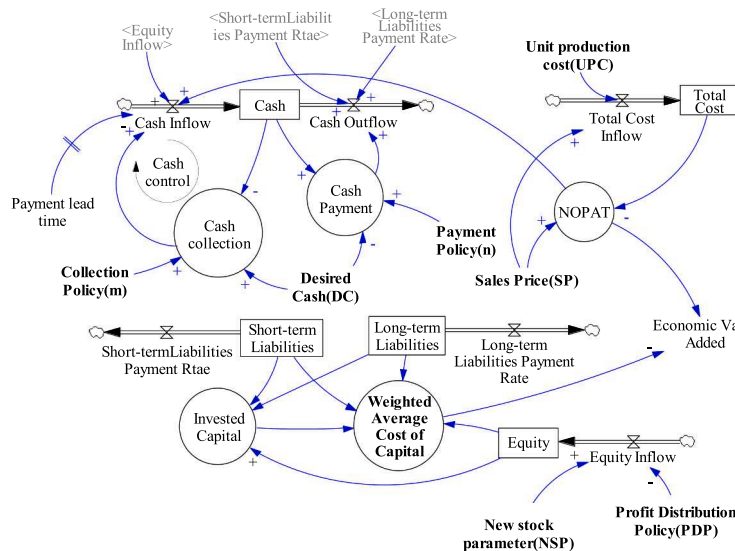

Fig. 4. Stock and flow diagram of financial flow.

adequacy test, and extreme condition test were employed to validate the developed SD simulation model. The model structure test evaluates whether the structure of the model matches the structure of the system being modelled [53]. In our model, every element of the model has a real-world counterpart in the physical and financial flows of the studied SC. The boundary adequacy test examines whether model boundaries match the purpose for which the model is designed [53]. As the objective of our model is to maximize economic profitability (EVA) for the studied SC, all of the factors affecting the EVA have been included in the model. The extreme condition test is used to show the robustness of our developed simulation model [54]. The extreme condition test assesses whether the model behaves appropriately according to its input values [54]. For example, the demand for a product goes to zero when there is a significant increase in the price [54]. In our developed model, EVA grows significantly when the sales price per unit of the product that is a

model input increases dramatically.

4.2.2. The genetic algorithm (GA)

The GA identifies the optimal values for the inventory and financial decision parameters in the SD simulation model. A detailed explanation of GA is given in Streichert [55]. GAs do not require derivative information found in analytical optimisation, but work well with numerically generated data, possess the ability to jump out of local minimum, and are able to optimise continuous and discrete parameters, particularly the continuous parameters [56]. GA is a perfect fit for optimising the SD simulation model in this study as the inventory and financial decision parameters that need to be optimised are continuous and the objective function presented in Eq. (37) is not available in an explicit form and is measured using the SD simulation model.

To optimise SD models using GAs, each solution known as a

chromosome is represented by an array of elements, where each position in the array pertains to a possible parameter value. A solution pool named population is formed by a set of chromosomes. The algorithm starts with setting up a population of random possible solutions. In this study, the random solutions are generated within the range of parameters defined by Eq. (38). The chromosomes are then evaluated based on the objective function to obtain the fitness of the solution. A fitness value shows how good each solution is in satisfying an objective function. We use the mean of the EVA presented in Eq. (37) as the fitness function of the GA. Applying the rule of survival of the fittest, the strongest solutions are selected from the population. We use the roulette wheel selection method to select the strongest solutions. Subsequently, solutions with higher fitness are combined to produce new solutions by performing a crossover operator. These solutions are known as parent solutions. We use the single-point crossover method. To ensure maintaining variety in the overall population, new solutions may then be subjected to small variations from parent solutions called mutation operator. We use the single-point mutation method. Each population then represents a generation, and the process continues until predefined stopping criteria are met, such as convergence of fitness over generations or reaching the maximum number of generations (Lu et al., 2012). We set the stopping criteria to be 300 generations.

Similar to the MILP model, the objective of the SBO model is to maximize the economic profitability of the studied SC that is measured by the EVA index. The objective function (37) is formulated as maximizing the mean of the EVA over the simulation period. Maximizing EVA is achieved by identifying the optimal values for the inventory and financial decision parameters of the simulation model that have been highlighted in Figs. 3 and 4. The feasible intervals for inventory and financial decision parameters are defined by Eq. (38).

$$\text{Objective function : } \text{Max EVA} = \text{Max } \mu_{EVA} \text{ Where } \mu_{EVA} = \frac{\sum_{t=0}^T \text{EVA}}{T} \quad (37)$$

Decision parameters:

$$\alpha_D, \alpha_{R1}, \alpha_{R2}, \alpha_{R3}, \beta_D, \beta_{R1}, \beta_{R2}, \beta_{R3}, m, n, \\ DDI, DDSL, DC, IAT, MIAT, MSSC, MCT, MMIC, MOPT, PDP, R1DI,$$

$$R1DSL, R2DI, R2DSL, R3DI, R3DSL, SP, NSP, TAOR, UPC, WIPAT$$

Subject to:

$$0 \leq \alpha_D, \alpha_{R1}, \alpha_{R2}, \alpha_{R3} \leq 1; 0 \leq \beta_D, \beta_{R1}, \beta_{R2}, \beta_{R3} \leq 1; 0 \leq m, n \leq 1; 0 \leq DDI \leq 60; 0 \leq R1DI, R2DI, R3DI$$

$$\leq 30; 0 \leq DDSL \leq 60; 0 \leq R1DSL, R2DSL, R3DSL \leq 30; 1 \leq IAT \leq 5; 1 \leq MIAT \leq 5; 0 \leq MSSC \leq 2;$$

$$0 \leq SSC \leq 2; 0 \leq MMIC \leq 5; 1 \leq MOPT \leq 3; 0 \leq PDP \leq 1; 200 \leq SP \leq 300; 0 \leq NSP \leq 1;$$

$$80 \leq UPC \leq 120; 1 \leq WIPAT \leq 5; 0 \leq DC \leq 2000; 1 \leq MCT \leq 3 \quad (38)$$

SBO is a modelling framework which incorporates an optimisation algorithm into a simulation model to determine the optimal simulation parameters configuration [57]. In SBO, the optimisation objective function is estimated using a simulation model [44]. The framework of the SBO is shown in Fig. 5. SBO is an iterative process which is launched by an optimization algorithm, i.e., GA that generates the initial values to the inventory and financial decisions parameters within the ranges defined by Eq. (38). The simulation model is then run using the generated values to evaluate system performance, i.e., mean of the EVA presented in Eq. (37). Thereafter, the performance measures are fed back into the optimization algorithm. Based on this feedback a new set of inventory and financial decision parameters are generated and inputted into the simulation model for evaluation [58]. This iterative process

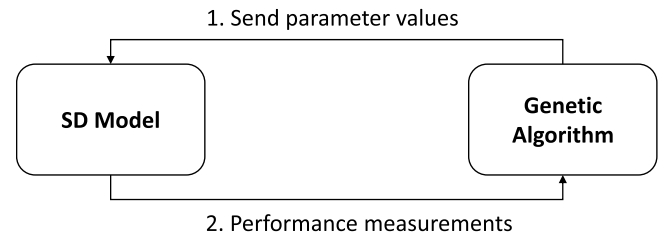

Fig. 5. SBO framework.

continues until a user-specified stop criterion such as performing a defined number of evaluations or the maximum number of generations is met [59]. We set the stopping criteria to be 300 generations.

4.3. MILP-SBO modelling

The MILP-SBO approach seeks to utilize the advantages of both MILP and SBO models. In the MILP-SBO framework, the decisions recommended by the MILP model and the decisions that are obtained by the balancing loops in the SD simulation model are integrated to determine the amount of raw material to be purchased, the production start rate and the shipment rates across the network. The material delivery rate (39) in this model is a function of the desired material order rate from the SD model and the material order rate from the MILP model. The production start rate (40) is determined by the desired production rate and the feasible production from the material determined by the SD model and the production rate recommended by the MILP model. The shipment rate of the manufacturer (MSR_d)(41) is determined by the maximum shipment rate to each distributor, the desired shipment rate of each distributor, and the shipment rate suggested by the MILP model. The amount of products that are shipped from each distribution centre to each retailer (DSR_{dr}) (42) is a function of the desired shipment rate of the distributor determined by the MILP model and the maximum shipment rate and the inventory of the distributor that are obtained from the SD model. The sale rate of each retailer (RSR_r) (43) is calculated by its customer demand, its inventory level, and the sale rate obtained from the MILP model. Employing the optimal decision variables determined by the MILP model to decide on decision variables in the SD model reduces the levels of inventory held by SC members and the level of cash held at SC.

$$\text{Material order rate} = \text{Min} \left(\text{Desired material order rate}, \sum_{s=1}^S X_{st} \right) \quad (39)$$

$$\text{Production start rate} = \text{Min}(\text{Desired production start rate}, \text{Feasible production from material}, PR_i) \quad (40)$$

$$MSR_d = \text{Min}(\text{Maximum shipment rate}_d, \text{Desired shipment rate}_d, SC_d) \forall d. \quad (41)$$

$$DSR_{dr} = \text{Min}(\text{Retailer order}_r, \text{Distributor inventory}_d, SDI_{dr}) \forall r, d. \quad (42)$$

$$RSR_r = \text{Min}(d_{rt}, \text{Retailer Inventory}_r, SR_r) \forall r. \quad (43)$$

5. A case study

The advantages of the MILP-SBO modelling are investigated by comparing it with the individual optimization and SBO methods through conducting empirical tests. The data for this case study is adopted from Longinidis and Georgiadis [12] and Longinidis and Georgiadis [26]. The range of parameter values expressed in Longinidis and Georgiadis [12] is extended to ensure that the optimal parameter values lie within the searching boundary.

The numerical experiment is scaled as follows: the number of customer zones, retailers, and distributors is three; the number of

production centres is one; the number of suppliers is two, and the number of periods is two one-year periods. Tables 2 and 3 present the production, inventory holding, and cash holding costs in each period. The transportation costs from suppliers to the production centre, from the production centre to distributors, and from distribution centres to the retailers are given in Tables 4–6, respectively. Tables 7 and 8 show the five parameters that represent economic uncertainty. Three scenarios are defined to reflect the uncertainties in five economic parameters including customer demand, expected return of the market, risk-free rate of interest, short-term interest rate, and long-term interest rate. It is assumed that in the first period, there is no economic uncertainty but at the start of the second period, there are three potential conditions including boom, stagnation, and, recession and these lead to three scenarios. During a boom period, economic prosperity leads to the increased purchasing power of customers which results in excessive demand for products and services. The expected return of the market rises, as the investors who are optimistic about the future of the companies present in the stock market increase their investment. The risk-free rate of interest, which is usually the interest rate of a governmental bond, falls as the risk of default diminishes. The risk of the borrower’s default decreases, therefore financial institutions charge lower short-term and long-term interest rates. On the other hand, during a recession period, the aforementioned parameters move in the opposite direction. In a stagnation period, it is assumed that the past shapes the future because there are minor deviations in the value of parameters comparing the preceding period [26].

The sales price of the product and production capacity in each period are presented in Table 9. Three models are developed based on optimization (MILP), SBO, and MILP-SBO methods. The results of each model are analysed and presented in the following sections.

5.1. Optimization model (MILP)

The values of the parameters in the optimization model (MILP) are randomly generated in the feasible interval of the parameter values using MATLAB software. For instance, to determine the unit production cost of the product in each period, two random data in the interval of [58–62] were generated. The MILP model focuses on identifying long-term decisions such as SC structure. Therefore, the material delivery and cash payment lead times are assumed to be zero; otherwise, the solving period must be subdivided into shorter periods, in this model weeks, to accommodate the lead times. Neglecting the lead times in material delivery and assuming zero safety stock, the MILP model recommends keeping no inventory at all with the SC members. Therefore, the EVA obtained from the MILP model is higher than the one gained from the SBO and MILP-SBO models that hold inventory, including finished goods and raw material. To establish a meaningful contrast between the MILP, SBO and MILP-SBO models, we assume that the SC members hold safety stock to hedge against the demand uncertainty. This reduces the EVA obtained from the MILP model compared to the case with zero safety stock. The MILP model is then used to determine the optimal network design and the production rates at the production centre. The computational time of the MILP model is low, less than 10 s, as it does not formulate the cash and inventory dynamics. Considering these converts the MILP model into a mixed integer non-linear programming model (MINLP) and significantly increases the computational time. As Table 10 shows the storage locations and the supplier determined by the MILP model for each scenario. Considering the possible

Table 2
Production and cash holding cost.

Production cost		Cash holding cost	
<i>t</i> = 1	<i>t</i> = 2	<i>t</i> = 1	<i>t</i> = 2
58.6	60.9	1.06	1.10

Table 3
Inventory holding costs at SC members.

Production centre		Distributors		Retailers	
<i>t</i> = 1	<i>t</i> = 2	<i>t</i> = 1	<i>t</i> = 2	<i>t</i> = 1	<i>t</i> = 2
58.6	60.9	8.2	8.9	8.2	8.9

Table 4
Transportation cost from suppliers to production centre.

To	Production centre	
From	<i>t</i> = 1	<i>t</i> = 2
Supplier 1	15.2	19.4
Supplier 2	18.6	20.7

Table 5
Transportation cost from production centre to distribution centres.

To	Distribution centre 1		Distribution centre 2		Distribution centre 3	
From	<i>t</i> = 1	<i>t</i> = 2	<i>t</i> = 1	<i>t</i> = 2	<i>t</i> = 1	<i>t</i> = 2
Production centre	20.2	23.4	25.2	61.4	65.8	72.3

Table 6
Transportation cost from distribution centres to retailers.

To	Retailer 1		Retailer 2		Retailer 3	
From	<i>t</i> = 1	<i>t</i> = 2	<i>t</i> = 1	<i>t</i> = 2	<i>t</i> = 1	<i>t</i> = 2
Distribution centre 1	25.7	34.3	52.6	54.5	95.4	79.8
Distribution centre 2	32.5	50.4	12.5	15.2	15.3	17.6
Distribution centre 3	89.1	68.9	69.4	63.1	29.3	33.6

Table 7
Customers’ demands in the predicted economic scenarios.

Scenario	Customer 1		Customer 2		Customer 3	
	<i>t</i> = 1	<i>t</i> = 2	<i>t</i> = 1	<i>t</i> = 2	<i>t</i> = 1	<i>t</i> = 2
<i>S</i> ₁	750	1125	730	1095	570	855
<i>S</i> ₂	750	750	730	730	570	570
<i>S</i> ₃	750	500	730	487	570	380

economic conditions at the start of the second year, the MILP model suggests purchasing the raw material from supplier no. 1 and to open Distribution centre no. 2.

Table 11 illustrates the MILP model results for some physical and financial variables in each scenario. Demand variability is caused by the economic uncertainty driving the production rate. Demand growth in scenario 1, is adjusted by increasing the production rate, while the demand shrinkage in scenario 3 is dealt through decreasing the production rate. In scenario 2, the MILP model recommends diminishing the production rate at year two, although the customer’s demand has remained unchanged. The reason is that the demand is partially met by the safety stock. The equality of the right and left sides of the balance sheet in each period shows the accuracy of the financial modelling. The profitability, NOPAT, and the economic performance, EVA, of the chain decrease when the economy diminishes in size as increasing cost of goods sold is not offset by neither demand growth nor reduction in financing expenses, i.e., cost of equity and cost of debt.

The structure of the current assets in each year for the three scenarios is illustrated in Fig. 6. In all scenarios at the end of the second year the highest and lowest shares of the current assets belong to the cash and inventory values, respectively. The inventory level at the end of the second year for all scenarios is similar and is equal to the safety stock, despite the demand differences. The structure of the capital in each year

Table 8
Macroeconomic parameters values in the predicted economic scenarios.

Scenario	Parameter							
	$STR_{t=0}^{[s]}$	$STR_{t=53}^{[s]}$	$LTR_{t=0}^{[s]}$	$LTR_{t=53}^{[s]}$	$r_{f,t=0}^{[s]}$	$r_{f,t=53}^{[s]}$	$r_{m,t=0}^{[s]}$	$r_{m,t=53}^{[s]}$
S_1	7.00	5.60	4.00	3.00	2.50	2.00	5.00	6.00
S_2	7.00	7.00	4.00	4.00	2.50	2.50	5.00	5.00
S_3	7.00	8.40	4.00	5.00	2.50	3.00	5.00	4.00

Table 9
Sale price and production capacity.

Sales price (pri)(GBP/Ton)		Production capacity (prcap) (Tons of products)	
$t = 1$	$t = 2$	$t = 1$	$t = 2$
235.6	270.94	2500	2500

for all scenarios is depicted in Fig. 7. The MILP model in all three scenarios recommends using long-term liabilities as the source of financing due to its lower interest rates compared to short-term liabilities and issuing new stocks. The growth of equity at the second year for all scenarios is triggered by the addition to retained earnings which is set to be 45 percent of the NOPAT.

5.2. MILP, SBO and MILP-SBO models

As explained in Section 4.3, the SBO model is constructed by incorporating genetic algorithms into the SD simulation model to identify the optimal values for the inventory and financial decision parameters of the simulation model that maximize the objective function, EVA. The parameters of the GA including the population size, crossover rate, and mutation rate are set to be 300, 0.8, and 0.1, respectively. The simulation time step is one week. The MILP-SBO model uses the optimal decision variables determined by the MILP model to decide on the quantity of the order to be placed with the suppliers, the production rate at the manufacturing site, and the shipment rates in the SC network. We also compare the performance of the MILP-SBO model with the MILP method proposed in the literature (e.g., [5,12]).

The MILP model was implemented in GAMS (25.1.1 ver.) and solved using CPLEX (12.8.0.0 ver.) solver, and the SBO simulation model was implemented in MATLAB (2021a ver.). All models run in an Intel(R) Core(TM) CPU i7-10610U @2.60 GHz with 32GB RAM.

5.2.1. Scenario 1

Scenario 1 assumes a boom in the second year of the simulation that increases customer demand and expected return of the market and a decrease in risk-free rate of interest, short-term interest rate and long-term interest rate. In terms of computational time, there is no considerable difference between the SBO and MILP-SBO models as both models consider the inventory and cash dynamics. The inventory and cash dynamics for the members in scenario 1 obtained from the SBO and MILP-SBO models are illustrated in Figs. 8(a)-(d) and 9(a)-(d), respectively. The MILP-SBO approach is more efficient than the SBO approach in managing the cash and inventory of the SC members as it uses the optimal values for the raw material order quantity, production rate, and

Table 10
Optimal storage locations and supplier selection by the MILP model under scenario 1, 2, and 3.

Decision variables	Suppliers				Distribution centres					
	S1		S2		DC 1		DC 2		DC 3	
Open/Close	$t = 1$	$t = 2$	$t = 1$	$t = 2$	$t = 1$	$t = 2$	$t = 1$	$t = 2$	$t = 1$	$t = 2$
Open=1	1	1	0	0	0	0	1	1	0	0
Close=0										

Table 11
Optimal values to the physical and financial flow variables.

Decision variables	Scenario 1		Scenario 2		Scenario 3	
	$t = 1$	$t = 2$	$t = 1$	$t = 2$	$t = 1$	$t = 2$
PR	2227.2	2500	2227.2	1890	2227.2	1207
SC	2027.2	2660	2027.2	2050	2027.2	1367
SDI	2007.2	2660	2007.2	2050	2027.2	1367
SR	2007.2	2660	2007.2	2050	2027.2	1367
FA + CA	720,200	768,971	720,200	743,099	720,200	720,261
LTL + STL + E	720,200	768,971	720,200	743,099	720,200	720,261
NOPAT	22,222	87,475	22,222	58,999	22,222	33,623
EVA	38,779		7023		-26,187	

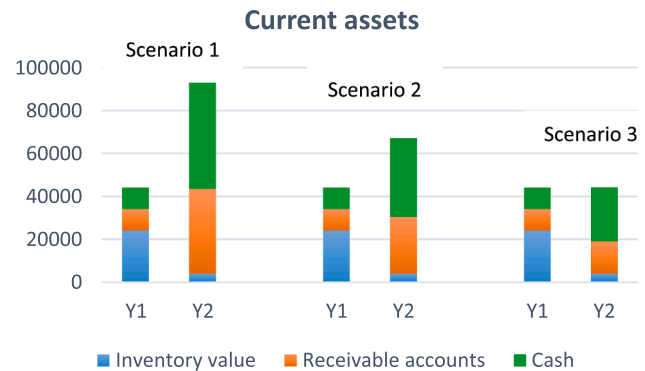

Fig. 6. Current assets structure.

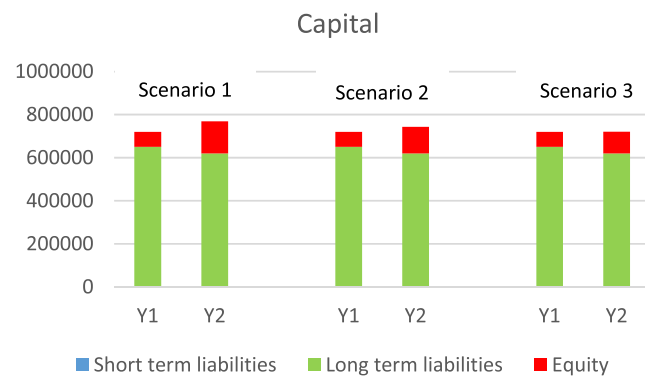

Fig. 7. Capital structure.

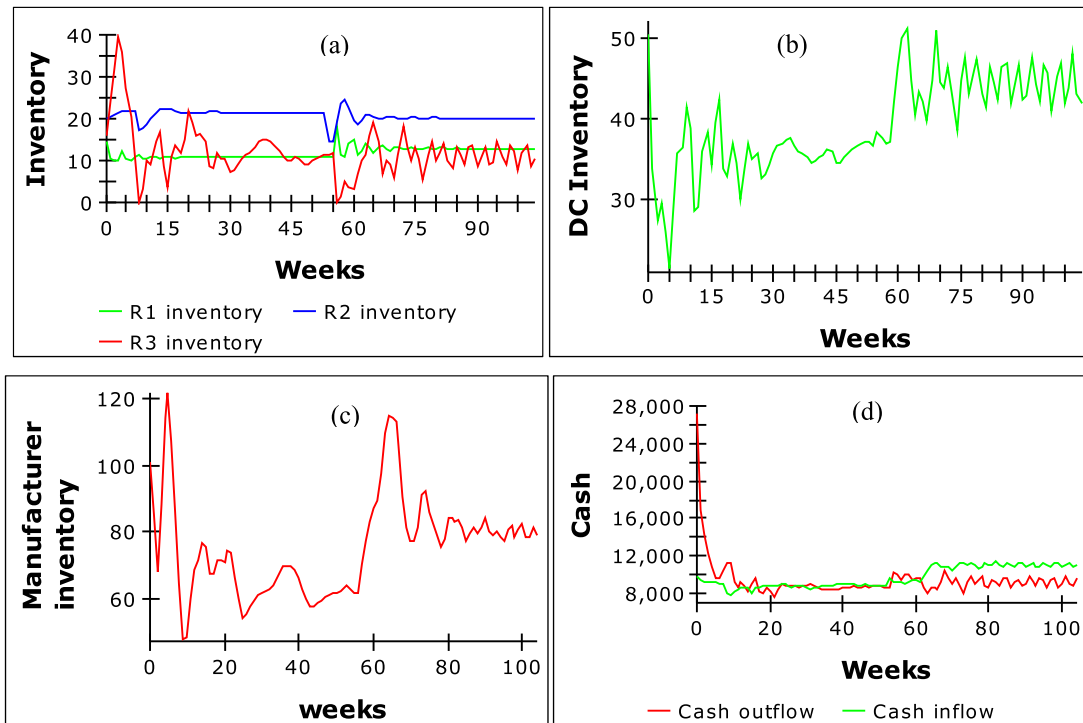

Fig. 8. Inventory and cash dynamics for the SC members in scenario 1 obtained from the SBO model.

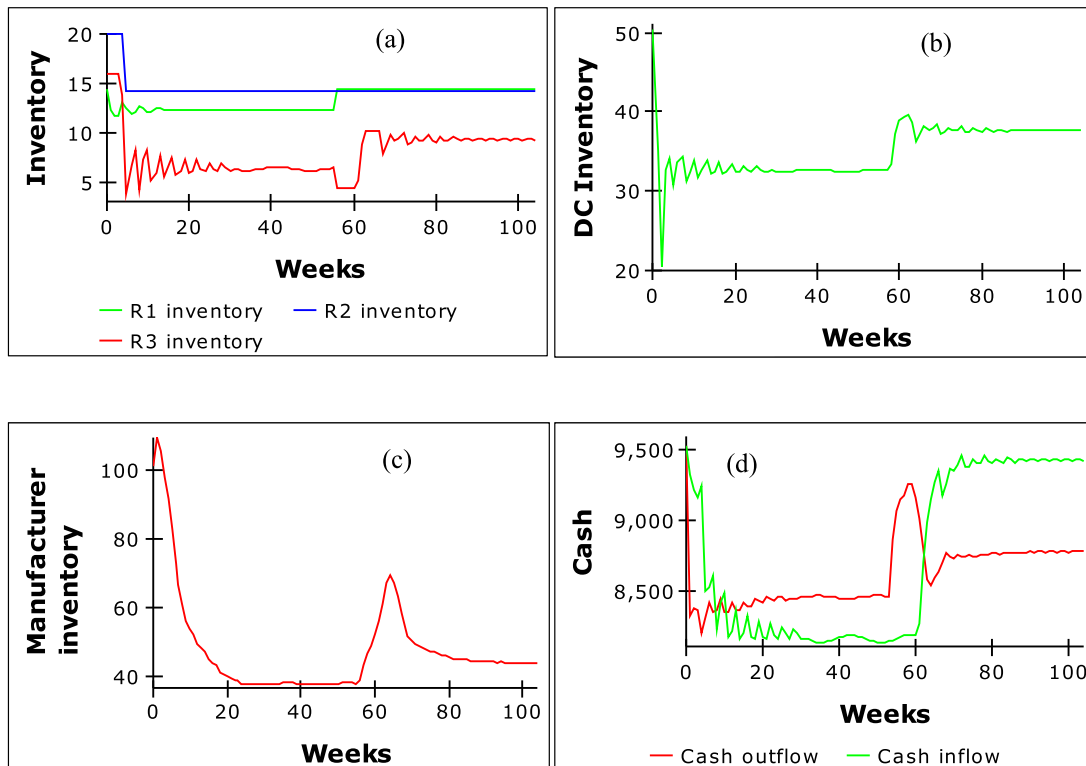

Fig. 9. Inventory and cash dynamics for the SC members in scenario 1 obtained from the MILP-SBO model.

shipment rate between the SC members when deciding on these variables for the simulation model. Both the inventory peaks and the oscillation in inventory ranges for SC members fall after using the MILP-SBO approach. Moreover, the inflow and outflow of cash in the MILP-SBO model are lower than the ones from the SBO model. Lower inventory and cash levels in the MILP-SBO model yield lower inventory

and cash costs compared to the SBO model. Consequently, the EVA of the SC obtained from the MILP-SBO model, £38,045, is 16% higher than the EVA obtained from the SBO model, £32,840. To compare the performance of the MILP-SBO and SBO models with the MILP model, 10 random realisations of the macroeconomic parameters, i.e. short-term interest rate, long-term interest rate, risk-free rate of interest, and

expected return of the market, are uniformly generated by changing the values of these parameters reported in Table 8 in the range of [−15%, +15%]. These parameters are then inputted into the MILP, SBO, and MILP-SBO models and the EVA of each realisation for each model is calculated. Table 12 reports the EVAs obtained from all models for each realisation. The mean of the EVAs obtained from the MILP model is 17% and 1.2% higher than the SBO and MILP-SBO models, respectively. The reason for this is that the MILP model does not consider the inventory and cash dynamics in the SC as opposed to the SBO and MILP-SBO models. Therefore, the recommended cash and inventory levels at SC members by the MILP model is lower than the recommended levels by the SBO and MILP-SBO models. The standard deviation of the EVAs obtained from the MILP-SBO model is 61% and 95% lower than the SBO and MILP models, respectively. This shows that the MILP-SBO model is more robust to changes in macroeconomic parameters than the SBO and MILP models. The reason for this is that the MILP-SBO model identifies the optimal values of the inventory and financial decision parameters shown in Eq. (38) and it uses the minimum function to ensure the feasibility of production and distribution values shown in Eq. (39)-(43). While the SBO only determines the optimal values of the inventory and financial decision parameters, and the MILP only identifies the optimal values of the production and distribution values without considering SC dynamics in the physical and financial flows.

5.2.2. Scenario 2

Scenario 2 assumes stagnation in the second year of the simulation that results in stability in customer demand, expected return of the market, risk-free rate of interest, short-term, and long-term interest rates. The inventory and cash dynamics for the members in scenario 2 obtained from the SBO and MILP-SBO models are illustrated in Figs. 10 (a)-(d) and 11(a)-(d), respectively. The performance of the MILP-SBO approach in decreasing the inventory levels for the retailers and distributor is not noticeably better than the SBO performance, as there is stability in customer demands. Using the MILP-SBO approach leads to a significant reduction in the inventory levels for the manufacturer. The inventory of the manufacturer in the MILP-SBO model from week 30 until the end of the simulation fluctuates in the range of [30,60] tonnes of product, while the inventory value at the same period in the SBO model remains stable at the level of 92 tonnes of product. Although the MILP-SBO approach does not significantly reduce the gap between the cash inflow and cash outflow, the number of weeks in which the cash outflow outstrips the cash inflow in the MILP-SBO model are 40 weeks, weeks 20 to 60, more than the SBO model that results in the lower cash costs in the MILP-SBO model compared to the SBO model. Lower inventory levels at the manufacturer and the cash held in the SC in the MILP-SBO model yield lower inventory and cash costs compared to the SBO model. Consequently, the EVA of the SC obtained from the MILP-SBO model, £6849, is 14% higher than the EVA obtained from the SBO model, £6008. Table 13 reports the EVAs obtained from each model by changing the values of macroeconomic parameters reported in the range of [−15%, +15%]. These parameters are then inputted into the

Table 12
Sensitivity analysis on the models in scenario 1.

No. of realisation	MILP model	SBO model	MILP-SBO model
1	39,964	32,893	37,993
2	39,626	32,901	37,870
3	39,979	32,667	37,953
4	37,070	32,574	37,922
5	38,070	32,543	38,003
6	37,651	32,750	38,074
7	37,565	32,808	37,904
8	40,123	32,984	38,016
9	37,235	33,111	37,919
10	37,061	32,703	38,068
Mean	38,434.4	32,793.4	37,972.2
Standard deviation	1252.41	163.97	62.99

MILP, SBO, and MILP-SBO models and the EVA of each realisation for each model is calculated. The mean of the EVAs obtained from the MILP model is 16% and 2.6% higher than the SBO and MILP-SBO models, respectively. Similar to scenario 1, this is because the MILP model does not consider the inventory and cash dynamics and therefore, the recommended cash and inventory levels at SC members by the MILP model are lower than the levels recommended by the SBO and MILP-SBO models. The standard deviation of the EVAs obtained from the MILP-SBO model is 36% and 90% lower than the SBO and MILP models, respectively. This shows that the MILP-SBO model is more robust to changes in microeconomic parameters than the SBO and MILP-SBO models. Similar to scenario 1 this is because the MIP model ignores SC dynamics in the physical and financial flows and the SBO only determines the optimal values of the inventory and financial decision parameters. While the MILP-SBO model identifies the optimal values of the inventory and financial decision parameters shown in Eq. (38) and it uses the minimum function to ensure the feasibility of production and distribution values shown in Eq. (39)-(43).

5.2.3. Scenario 3

Scenario 3 assumes recession in the second year of the simulation that results in a decrease in customer demand and expected return of the market and an increase in the risk-free rate of interest, short-term and long-term interest rate. The inventory and cash dynamics for the members in scenario 3 obtained from the SBO and MILP-SBO models are illustrated in Figs. 12(a)-(d) and 13(a)-(d), respectively.

Compared to the SBO model, the MILP-SBO approach does not significantly diminish the inventory levels for the SC members. However, it reduces the oscillations in the inventory levels of the members. As in scenario 2, the gap between the cash inflow and cash outflow in the MILP-SBO model is not significantly lower than the one in the SBO model, while the number of weeks in which the cash outflow outstrips the cash inflow in the MILP-SBO model is 30 weeks, weeks 20 to 50, more than the SBO model. This results in lower cash costs in the MILP-SBO model compared to the SBO model. Consequently, the EVA of the SC obtained from the MILP-SBO model, £−26,657, is 6.18% higher than the EVA obtained from the SBO model, £−28,414.

Table 14 reports the EVAs obtained from each model by changing the values of macroeconomic parameters reported in Table 8 in the range of [−15%, +15%]. The mean of the EVAs obtained from the MILP model is 8% and 1.3% higher than the SBO and MILP-SBO models, respectively. Similar to scenarios 1 and 2, this is because the recommended cash and inventory levels by the MILP model is lower than the levels recommended by the SBO and MILP-SBO models. The standard deviation of the EVAs obtained from the MILP-SBO model is 49% and 69% lower than the SBO and MILP models, respectively. This shows that the MILP-SBO model is more robust to changes in microeconomic parameters than the SBO and MILP-SBO models. This is explained by the same reason given in scenarios 1 and 2.

Table 15 shows the number of iterations performed to meet the stopping criterion, which is no improvement in the value of the EVA obtained from the MILP-SBO model, in each scenario. For each iteration in each scenario, the GA was run 15 times. The results are reported in Table 16. The results indicate the maximum stopping iterations of three in scenario 1 and two in scenarios 2 and 3. Although, it is not feasible to prove the rapid convergence of the EVAs obtained from the MILP-SBO model for all the test results as the GA is a stochastic search algorithm. The results of the comparison between the values of the EVA obtained from the MILP-SBO model and the values obtained from the MILP and SBO models are shown in Table 16. The MILP-SBO approach outperforms the SBO approach as it decreases the levels of cash and inventory in SC.

6. Concluding discussion

Integrating SC finance into SC planning is critical as it ensures the

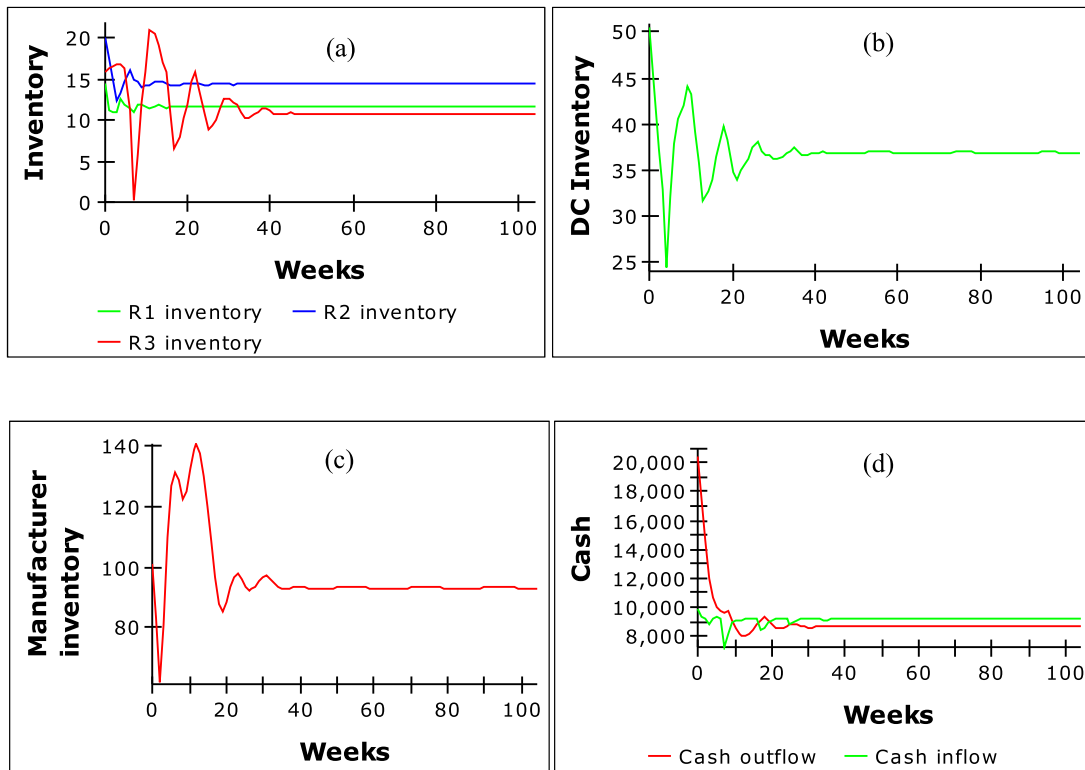

Fig. 10. Inventory and cash dynamics for the SC members in scenario 2 obtained from the SBO model.

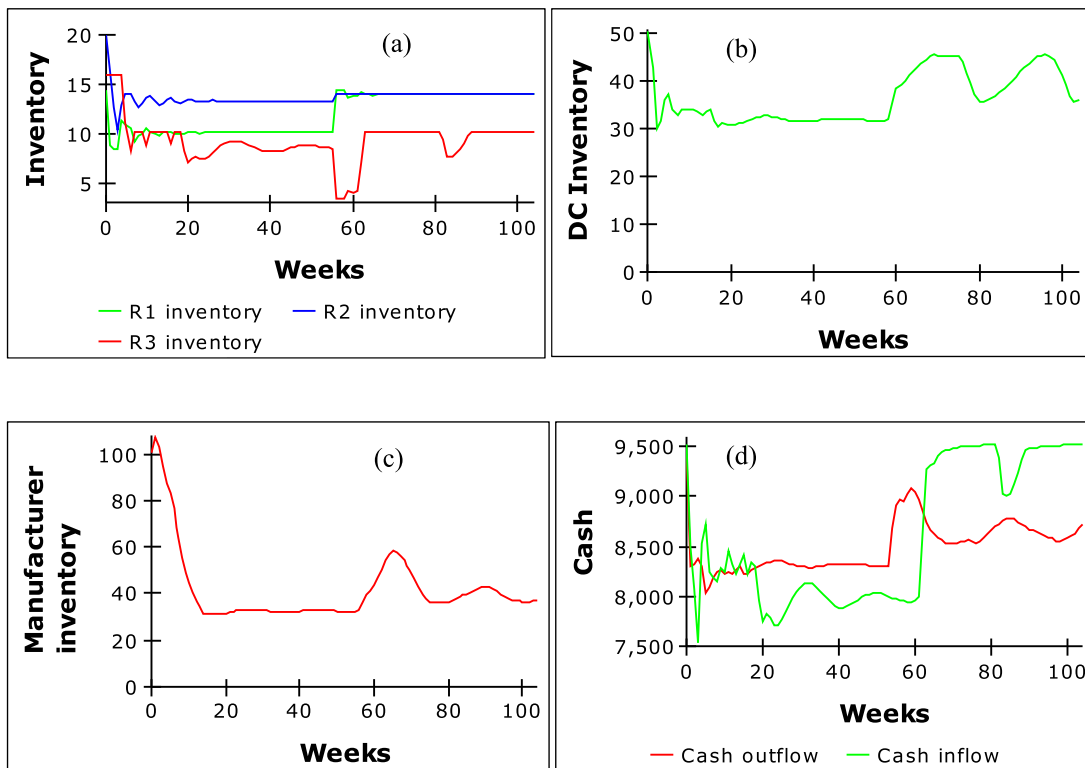

Fig. 11. Inventory and cash dynamics for the SC members in scenario 2 obtained from the MILP-SBO model.

availability of the financial resources for implementing planning decisions in SCs. Considering the economic uncertainty in SC planning and finance is of paramount importance as this improves the accuracy of the expected SC profit. To address an SC planning and finance problem

nonlinearities, feedback loops and delays that exist in the physical and financial flows of SCs along with economic uncertainty need to be considered.

MILP and SBO models have been applied by researchers to address

Table 13
Sensitivity analysis on the models in scenario 2.

No. of realisation	MILP model	SBO model	MILP-SBO model
1	6850	6047	6834
2	6946	6068	6829
3	7090	6007	6851
4	6844	6016	6855
5	6908	6009	6853
6	7180	6047	6853
7	7057	6050	6820
8	6923	6040	6851
9	7187	6015	6823
10	7193	6058	6829
Mean	7017.8	6035.7	6839.8
Standard deviation	133.02	19.93	12.69

the SC planning and finance problem. MILP models help to identify the optimal values for the strategic and tactical decisions, while they ignore the nonlinearities, feedback loops and delays that exist in the physical and financial flows of the SCs. SBO models take into account the nonlinearities, feedback loops, and delays exist in the physical and financial flows of the SCs, while they cannot identify the optimal values for the strategic and tactical decisions such as the structure of the SC. MILP-SBO modelling is an effective tool for addressing the SC planning and finance problem as it can efficiently capture nonlinearities, delays, and feedback loops that exist in physical and financial flows of the SCs and is also able to identify the optimal values for the strategic and tactical decisions. In this study, a MILP-SBO approach is presented to solve a SC planning and finance problem under economic uncertainty. The proposed model aims to maximize the EVA generated in an SC and deals with economic uncertainty by considering three predicted economic scenarios.

6.1. Theoretical contributions

This paper contributes to two research domains: SC planning and finance, and simulation-optimization modelling for SC management. SC planning and finance models (e.g., [15–17,19,25]) are mostly

optimization models, i.e., MILP, that ignore the uncertainties in macroeconomic parameters. To address this gap in the literature, we developed a simulation-optimization model in this study that considers the uncertainties in four macroeconomic parameters including short-term interest rate, long-term interest rate, expected return of the stock market, and the risk-free rate of interest in addition to the uncertainty in one microeconomic parameter, i.e., demand. Simulation-optimization models that have been developed for addressing SC problems (e.g., [36,38–40,42,45]) predominantly applied discrete-event simulation (DES) as the simulation approach and ignored the flow of funds within SC networks. Moreover, these models solely optimized the decision parameters of the simulation models and do not provide the optimal values to the decision variables of the simulation models. To address this gap in the literature, the developed model in this study integrates planning of the financial and physical flows within SC networks through combining an optimization model, i.e., MILP, and a simulation-based optimization model that includes a system dynamics simulation model and a genetic algorithm. The developed MILP-SBO model identifies the optimal values for the decision variables of the simulation model such as the flow of products amongst SC members and production rate in addition to the optimal values for the decision parameters of the simulation model such as policies on payables and receivables. To demonstrate the feasibility of the developed simulation-optimization approach, it is applied to address an integrated supplier selection, network design, production and inventory planning, and asset-liability planning problem in an SC system.

The presented approach is initialized by solving the MILP model to determine the optimal values for the amount of raw material required to be purchased from the suppliers, the production rate at the manufacturing site, and the flow of finished products between the SC members considering the existing constraints in the financial and physical flows. The solution suggested by the MILP model is then used to construct the SBO model that formulates the distribution and payment lead times, the feedback loops, and nonlinearities rooted in an SC network. Thereafter, the embedded GA in the SBO model is run to identify the optimal values for the price per tonne of the product, the

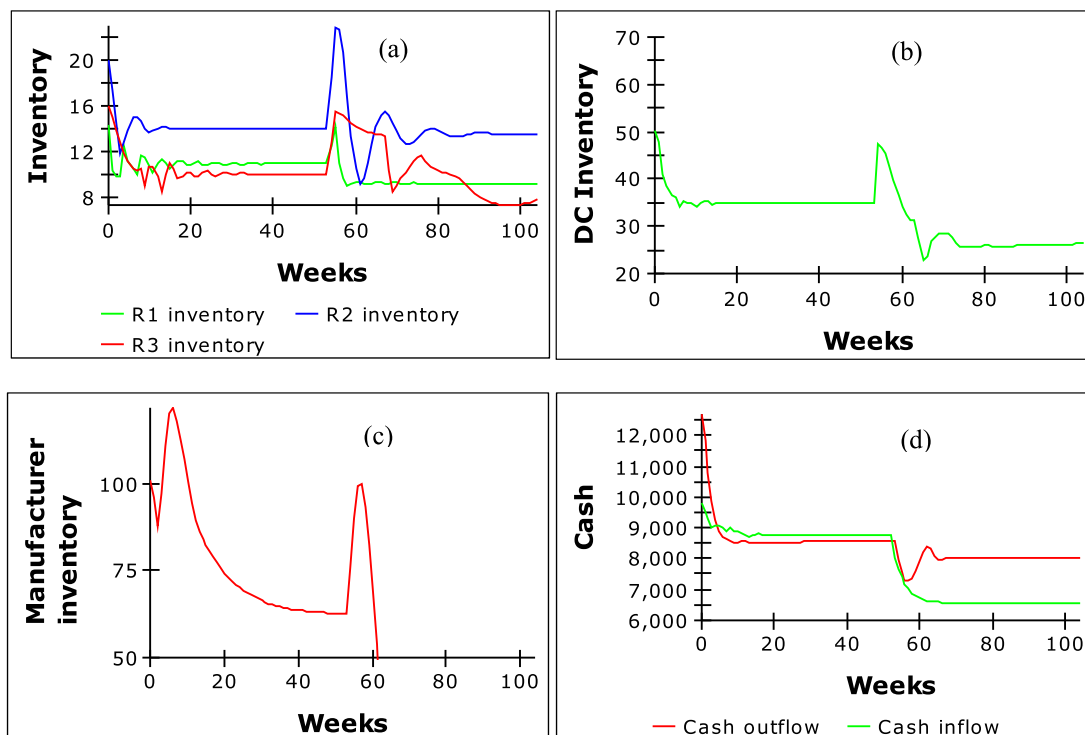

Fig. 12. Inventory and cash dynamics for the SC members in scenario 3 obtained from the SBO model.

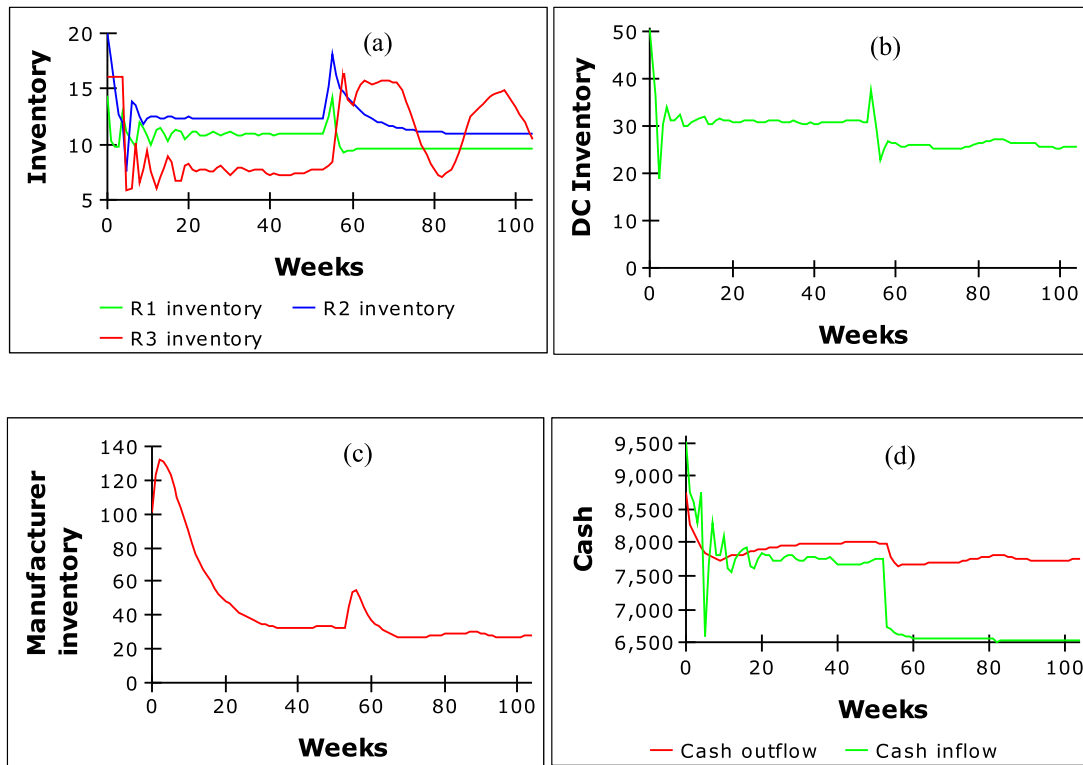

Fig. 13. Inventory and cash dynamics for the SC members in scenario 3 obtained from the MILP-SBO model.

Table 14
Sensitivity analysis on the models in scenario 3.

No. of realisation	MILP model	SBO model	MILP-SBO model
1	-26,173	-28,498	-26,590
2	-26,388	-28,539	-26,632
3	-26,093	-28,675	-26,645
4	-26,448	-28,497	-26,614
5	-26,299	-28,502	-26,563
6	-26,211	-28,496	-26,611
7	-26,104	-28,564	-26,576
8	-26,265	-28,453	-26,534
9	-26,233	-28,677	-26,586
10	-26,375	-28,496	-26,665
Mean	-26,258.9	-28,539.7	-26,601.6
Standard deviation	119.91	73.53	37.63

Table 15
Convergence of EVA obtained from MILP-SBO model in each scenario.

Scenario	Iteration number	Fitness value			
		Worst (Min)	Best (Max)	Mean	Standard deviation
Scenario 1	1	35,951	36,674	36,548	47.29
	2	37,163	37,794	37,658	26.24
	3	37,956	38,084	38,045	10.34
	4	37,956	38,076	38,023	9.67
Scenario 2	1	5755	6129	6081	30.56
	2	6734	6872	6849	16.41
	3	6764	6841	6825	6.42
Scenario 3	1	-29,344	-28,549	-28,574	28.19
	2	-27,063	-26,579	-26,657	12.65
	3	-27,009	-26,618	-26,673	10.54

desired cash, the profit distribution policy, and the stocking capacities of the SC members. In the next stage, the constraints of the optimization problem are revised in accordance with the optimal parameter values

Table 16
EVA obtained from the MILP-SBO model in each scenario.

Scenarios	EVA (GBP)	Number of iterations	Percentage difference between the MILP-SBO model and the MILP model	Percentage difference between the MILP-SBO model and the SBO model
Scenario 1	38,045	3	-1.89%	+15.85%
Scenario 2	6849	2	-2.47%	+14.42%
Scenario 3	-26,657	2	-1.79%	+6.18%

recommended by the SBO model and the optimization problem is run to generate a new set of parameter values to be inputted into the SBO model. The iterative process between the MILP and SBO models continues until the stopping criterion which is no improvement in the value of EVA is met. The MILP-SBO approach enables the modeller to not only take into account the lead times, feedback loops, and nonlinearities which exist in the SC physical and financial flows, but also dramatically bridges the gap between the desired EVA, the EVA obtained from the MILP model, and the real EVA, the EVA gained from the SBO model.

The performance of the MILP-SBO model in maximizing the EVA is compared with the performances of the SBO model under three economic scenarios. The first scenario assumes boom at the second year of the simulation that results in increase in customer demand and expected return of the market and decrease in risk-free rate of interest, short-term interest rate and long-term interest rate. The MILP-SBO significantly reduced the inventory levels for the SC members and the cash held in the SC. Moreover, the EVA of the SC increased by almost 16% from £32,840 to £38,045. The second scenario assumes stagnation at the second year of the simulation that results in stability in customer demand, expected

return of the market, risk-free rate of interest, short-term and long-term interest rates. The MILP-SBO significantly reduced the inventory levels at the manufacturer and the cash held in the SC. The EVA of the SC increased by 14% from £6008 to £6849. The third scenario assumes recession at the second year of the simulation that results in a decrease in customer demand and expected return of the market and increase in risk-free rate of interest, short-term and long-term interest rate. The differences between the inventory levels of the SC members in SBO and MILP-SBO models are negligible as a 50% reduction in customer demand at the second year makes holding high inventory levels unnecessary. However, the MILP-SBO model reduces the oscillations in the inventory levels of the members. The EVA of the SC increased by 6% from £-28,414 to £-26,657. The results of the sensitivity analysis on macroeconomic parameters showed that the MILP-SBO model is more robust to changes in microeconomic parameters than the SBO and MILP-SBO models.

6.2. Managerial implications

Businesses need to keep sufficient cash to meet their operations expenses such as buying raw material and also pay dividends to their investors. The higher the cash level held by a business, the lower the possibility of the business' inability in meeting operations expenses and paying dividends. Although keeping a high cash level by a business ensures its capability in meeting operations expenses and paying dividends, it imposes the cash opportunity cost on the business. In other words, the business is foregoing the return that would have been derived by investing the cash in alternative options to holding it such as investing the cash in the stock market. Therefore, managers need to make a trade-off between adequacy of cash for meeting business expenses and minimizing the opportunity cost that the business incurs as a result of holding cash. This study helps the SC managers make this trade-

off by considering cash holding cost as an element of the total cost of the business and ensuring the cash level of the business is minimized. Moreover, SC managers can monitor the cash level in the SC and assess the impact of cash retention policies on SC profitability by running what-if scenarios in the SBO model.

SCs are exposed to uncertainties in macroeconomic and microeconomic parameters that may have significant impacts on their profitability. SC managers need to ensure that the impact of these uncertainties is taken into account while measuring the profitability of their SCs, otherwise the profitability of the SC may represent a misleading view of the financial health of the SC. To obtain a more accurate SC profit, in this study, the impacts of uncertainties in four macroeconomic parameters including short-term interest rate, long-term interest rate, expected return of the market, and risk-free rate of interest and uncertainty in one macroeconomic parameter that is demand on SC profit are considered.

6.3. Limitations and future work

The limitations of this work that need to be studied in the future research are as follows. Firstly, this study only examines the use of MILP-SBO approach to address an SC planning and finance problem. In future research other integrated SC planning problems such as integrated network design, distribution and transportation planning could be solved using the MILP-SBO approach or other hybrid modelling approaches. Secondly, the simulation approach applied in this study is SD, it would be interesting to investigate the capability of optimization-SBO models that employ simulation models rather than SD in addressing SC planning problems. Finally, multi-objective optimization can also be incorporated into the developed MILP-SBO model as an extension to the present study.

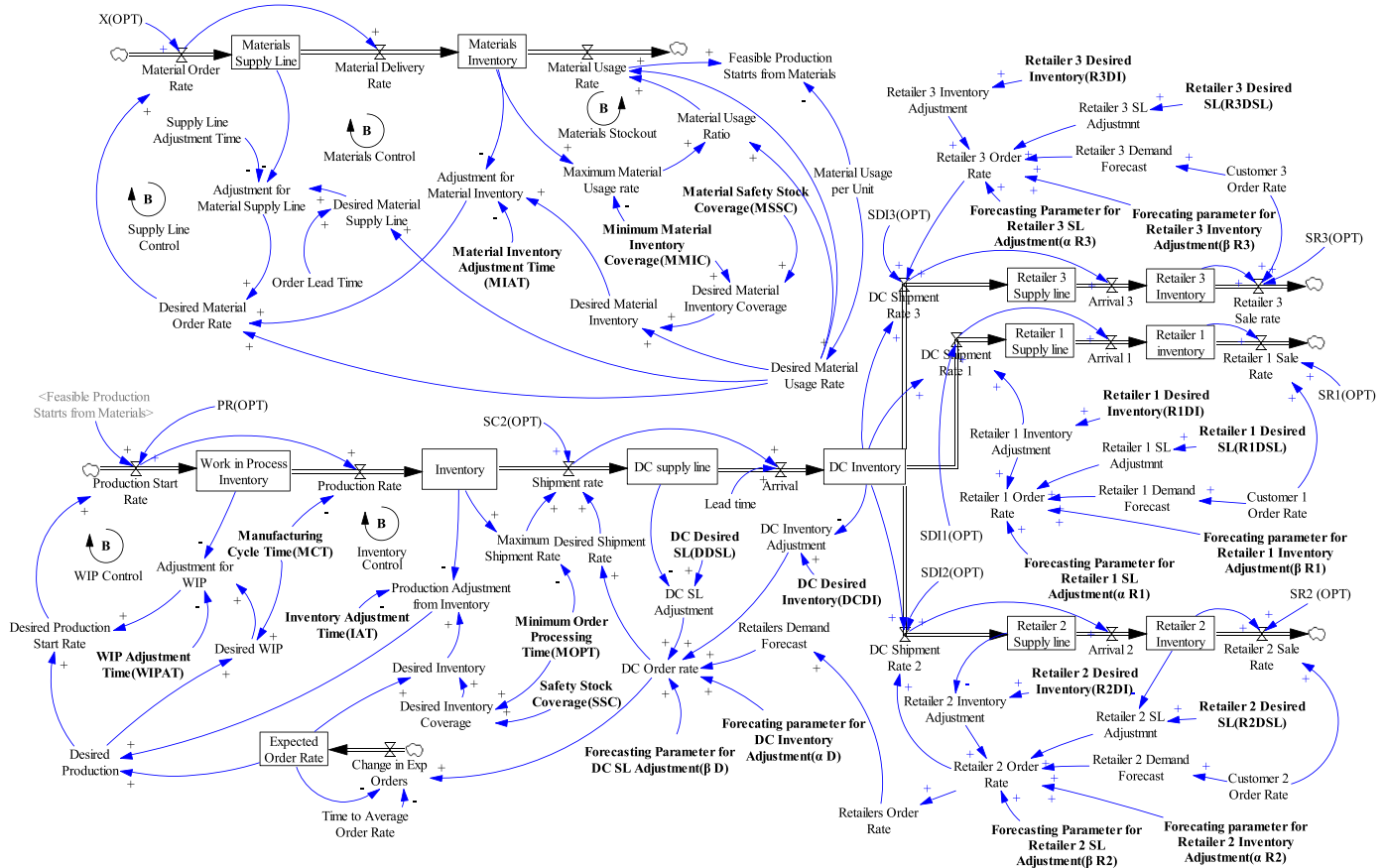

Fig. 14. Detailed stock and flow diagram of the physical flow.

CRedit authorship contribution statement

Ehsan Badakhshan: Conceptualization, Methodology, Software, Writing – original draft, Writing – review & editing. **Peter Ball:** Conceptualization, Methodology, Software, Writing – review & editing, Supervision.

Declaration of Competing Interest

All authors declare that they have no conflicts of interest.

Data availability

No data was used for the research described in the article.

Appendix

The detailed explanation of the equations in the SBO model is given as follows. Fig. 14 shows the detailed stock and flow diagram of the physical flow. It illustrates the relationships between the parameters and variables in the modules introduced in Fig. 3.

Material order quantity module

The material's inventory (44) is replenished by the delivery of placed orders and depleted by the material usage rate. The suppliers are able to fulfil the entire order of the production centre. Therefore, the delivery rate of the raw material (45) is equal to the desired delivery rate of the manufacturer. The current material inventory level either meets the demand for required raw material for production or is able to fulfil part of the demand (46).

$$\frac{d(\text{Material Inventory})}{d(t)} = \text{Material delivery rate} - \text{Material usage rate} \quad (44)$$

$$\text{Material delivery rate} = \text{Desired material delivery rate} \quad (45)$$

$$\text{Material usage rate} = \text{Min}(\text{Production start rate} \times \text{Material usage per unit}, \text{Material Inventory}) \quad (46)$$

Production module

The production start rate (47) is determined by the desired production rate and the feasible production from material inventory. The unfinished products are aggregated in work in process (WIP) inventory (48) and are converted into finished goods (FG) (49) after elapsing the production lead time (L_2). The inventory of the finished products (50) is replenished by the production rate and depleted by the shipment to the suppliers.

$$\text{Production start rate} = \text{Min}(\text{Desired production start rate}, \text{Feasible production from materials}) \quad (47)$$

$$\frac{d(\text{WIP Inventory})}{d(t)} = \text{Production start rate} - \text{Production rate} \quad (48)$$

$$\text{Production rate} = \text{Delay}(\text{Production start rate}, L_2, \text{initial value}) \quad (49)$$

$$\frac{d(\text{FG Inventory})}{d(t)} = \text{Production rate} - \text{Shipment rate} \quad (50)$$

Distribution centres order quantity module

The amount of products which are shipped to each distribution centre (MSR_d) (51) is a function of desired shipment rate determined by the desired shipment rate of each distributor which is equal to the distributor's order and the maximum shipment rate (52) that is calculated via dividing the on hand inventory of finished goods by a fixed minimum order processing time ($MOPT$) for the manufacturer. The on hand inventory of finished goods (53) is calculated by subtracting the shipped products from the finished goods inventory, and its value must always be positive.

$$MSR_d = \text{Min}(\text{Maximum shipment rate}_d, \text{Desired shipment rate}_d) \quad \forall d. \quad (51)$$

$$\text{Maximum shipment rate}_d = \frac{\text{Manufacturer FG on hand Inventory}}{MOPT} \quad \forall d. \quad (52)$$

$$\text{FG on hand Inventory} = \text{Max}\left(0, \text{Manufacturer FG Inventory} - \sum_{d=1}^{d-1} MSR_d\right) \quad \forall d. \quad (53)$$

The shipped products by the manufacturer to each distribution centre are accumulated in distributors supply lines (54) and arrive after a fixed lead time (L_d) (55) that represents the transportation time from manufacturer to each distribution centre. The inventory of each distributor (56) is replenished by arrival of the shipped products and depleted by shipment to the retailers.

$$\frac{d(\text{Distributor}_d \text{ SL})}{d(t)} = MSR_d - \text{Arrival}_d \quad \forall d. \quad (54)$$

$$\text{Arrival}_d = \text{Delay}(MSR_d, L_d, \text{initial value}) \quad \forall d. \quad (55)$$

$$\frac{d(\text{Distributor}_d \text{ Inventory})}{d(t)} = \text{Arrival}_d - \text{DSR}_d \quad \forall d. \tag{56}$$

Retailers order quantity module

The amount of products which are shipped from each distribution centre to each retailer (DSR_{dr}) (57) is a function of the distributor on-hand inventory and the retailer order. The on-hand inventory of finished goods (58) for each distributor is calculated by subtracting the shipped products from its inventory, and its value must always be positive. It is assumed that retailer 1 precedes retailer 2 and retailer 2 precedes retailer 3 when the manufacturer ships the inventory to the distributors.

$$\text{DSR}_{dr} = \text{Min}(\text{Retailer order}_r, \text{Distributor on hand inventory}_d) \quad \forall r, d. \tag{57}$$

$$\text{Distributor on hand Inventory}_d = \text{Max}\left(0, \text{Distributor Inventory}_d - \sum_{r=1}^{r-1} \text{DSR}_{dr}\right) \quad \forall d. \tag{58}$$

The shipped products by the distributors to each retailer are aggregated in retailers supply lines (59) and arrive after a fixed lead time (L_{dr}) (60) which relates to the transportation time from each distributor to any retailer. The inventory of each retailer (61) is replenished by arrival of the shipped products and depleted by shipment to the end customers. Finally, each retailer either meets the demand of its end customer or is able to fulfil part of the demand by its current inventory level (62).

$$\frac{d(\text{Retailer}_r \text{ SL})}{d(t)} = \sum_{d=1}^D \text{DSR}_{dr} - \text{Arrival}_r \quad \forall r. \tag{59}$$

$$\text{Arrival}_r = \text{Delay}(\text{DSR}_{dr}, L_{dr}, \text{initial value}) \quad \forall r. \tag{60}$$

$$\frac{d(\text{Retailer}_r \text{ Inventory})}{d(t)} = \text{Arrival}_r - \text{RSR}_r \quad \forall r. \tag{61}$$

$$\text{RSR}_r = \text{Min}(\text{ECD}_r, \text{Retailer Inventory}_r) \quad \forall r. \tag{62}$$

Fig. 15 shows the detailed stock and flow diagram of the financial flow. It illustrates the relationships between the parameters and variables in the

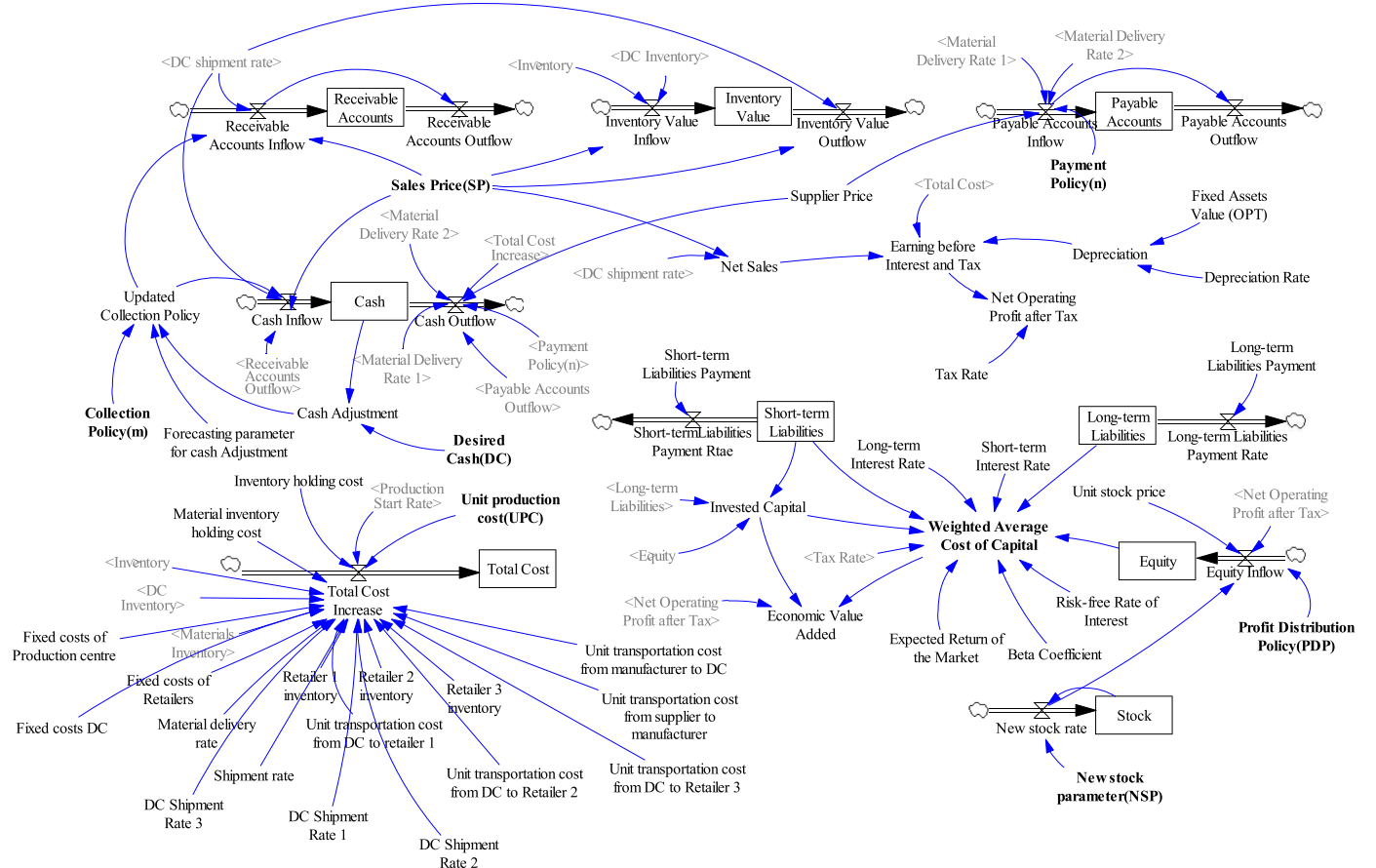

Fig. 15. Detailed stock and flow diagram of the financial flow.

modules introduced in Fig. 4.

Cash collection and cash payment modules

The inventory of cash (63) is replenished by receiving cash from end customers and is depleted by cash payment to suppliers and third-party creditors. The initial value of the cash level is the sum of short-term and long-term liabilities. Retailers collect part of customers' order values in cash, while the remaining part of the customer debt is accumulated in receivable accounts (RA) and is paid after d_c weeks. The cash inflow (64) is calculated by aggregating the customers' cash payment and receivable accounts from d_c weeks ago (65). The updated collection policy (um) (66) which is a parameter between 0 and 1 indicates the amount of customers' order value that must be collected in cash and is calculated by adding the cash adjustment to the original collection policy. The updated cash collection policy cannot exceed 1. Adjustment for cash (67) is calculated via multiplying cash gap percentage and the forecasting parameter for cash adjustment (γ) which represents the aggressiveness of the decision maker in bridging the gap between the desired and current cash levels. The outflow of cash (68) is prompted by payment to the suppliers, repayment for short-term and long-term liabilities, investment for fixed assets, and the total cost. When the manufacturer places an order to his suppliers, he pays part of the order value in cash and the outstanding debt is paid after d_1 weeks. The payment policy (n) that is a parameter between 0 and 1 shows the amount of manufacturer's order value that must be paid in cash. The remaining part of the manufacturer's debt is accumulated in payable accounts (PA) and is paid after d_1 weeks (69).

$$\frac{d(\text{Cash})}{d(t)} = \text{Cash inflow} - \text{Cash outflow} \tag{63}$$

$$\text{Cash inflow} = \sum_{r=1}^R \text{um } SR_{r,pri} + \text{RA outflow} \tag{64}$$

$$\text{RA outflow} = \text{Delay}(\text{RA inflow}, d_c, \text{initial value}) \tag{65}$$

$$\text{um} = \text{Min}(m + \text{CS Adjustment}, 1) \tag{66}$$

$$\text{Cash Adjustment} = \gamma \left(\frac{\text{Desired cash} - \text{cash}}{\text{cash}} \right) \tag{67}$$

$$\text{Cash outflow} = \sum_{s=1}^S n X_s Spri_s - \text{PA outflow} - \text{STL payment} - \text{LTL payment} - \text{FA investment} - \text{Total cost rate} \tag{68}$$

$$\text{PA outflow} = \text{Delay}(\text{PA inflow}, d_1, \text{initial value}) \tag{69}$$

NOPAT and invested capital modules

The total cost comprises the elements presented in Eq. (9). The production cost (70) is calculated via multiplying unit production cost (upc) by production start rate which might not be equal to the production rate recommended by the optimization model. The transportation cost (71) contains the shipment rates which are constrained by the maximum shipment capacity of each SC member. The inventory dynamics and cash dynamics are considered for measuring the inventory holding cost (72) and cash holding cost (73), respectively. While the optimization model solely takes into account the inventory and cash levels at the start and the end of each time period. The fixed cost is determined by the optimization model and inputted to the SBO model as an exogenous constant. The material order rate within the SBO model is recommended by the MILP model, therefore, the raw material costs determined by the simulation and optimization models are identical.

$$PC = \text{Production start rate} \times upc \tag{70}$$

$$TCR = \sum_{s=1}^S tc_s X_s + \sum_{d=1}^D tcc_d MSR_d + \sum_{r=1}^R \sum_{d=1}^D tcd_{dr} DSR_{dr} \tag{71}$$

$$HC = hr \text{ Average}(FIR) + hp \text{ Average}(FIP) + ho \text{ Average}(FIO) + hs \text{ Average}(FIS) \tag{72}$$

$$CHC = ucc \text{ Average}(CS) \tag{73}$$

The payment to the third-party creditors depletes the levels of short-term (74) and long-term liabilities (75) with a fixed rate. The initial levels of the short-term and long-term liabilities is determined by the optimization model. Finally, in each time period the equity (76) level rises by the share of NOPAT that is not distrusted amongst shareholders and new stocks that are issued.

$$\frac{d(\text{Short - term Liabilities})}{d(t)} = -\text{Short term liabilities payment} \tag{74}$$

$$\frac{d(\text{Long - term Liabilities})}{d(t)} = -\text{Long term liabilities payment} \tag{75}$$

$$\frac{d(\text{Equity})}{d(t)} = \text{NOPAT} \times (1 - \text{profit distribution policy}) + \text{new stock rate} \tag{76}$$

The detailed explanation on the inventory and financial decisions parameters of the simulation model is given as follows.

$\alpha_D, \alpha_{R1}, \alpha_{R2}, \alpha_{R3}$: denote the aggressiveness of the members in bridging the gap between the desired and current inventory.
 $\beta_D, \beta_{R1}, \beta_{R2}, \beta_{R3}$: denote the level of consideration to the inventory on-orders at the time of order placement
 m = collection policy: denotes the share of the sales is required to be collected in cash
 n = payment policy: denotes the share of the raw material purchase is required to be paid in cash
 $DDI, R1DI, R2DI, R3DI$: denote the desired inventory by distributor and retailers
 $DDSL, R1DSL, R2DSL, R3DSL$: represent the desired inventory on order by distributor and retailers
 IAT = The inventory adjustment time: represents the time period over which the manufacturer seeks to bridge the gap between the desired and current inventory of finished products
 $MIAT$ = The material inventory adjustment time: represents the time period over which the manufacturer seeks to bridge the gap between desired and current inventory of the raw material
 $MSSC$ = The manufacturer safety stock coverage: represents the time period over which the manufacturer would like to maintain a safety stock coverage to hedge against volatility in distributor's demand
 SSC = The safety stock coverage: represents the time period over which the manufacturer would like to maintain a safety stock coverage in order to meet any variations in distributor's demands
 $MMIC$ = The minimum material inventory coverage: represent the minimum material inventory required by the manufacturer
 $MOPT$ = The minimum order processing time: denotes the minimum time required by the manufacturer to process and ship a distributor order
 PDP = The profit distribution policy: denotes the dividends that is required to be paid to the shareholders
 SP = The sales price: The price per tonne of product which is paid to the retailers by the customers
 NSP = New stock parameter : represents the level of the stock that should be issued
 UPC = The unit production cost: denotes the production cost per tonne of product at the manufacturer
 $WIPAT$ = The WIP adjustment time: represents the time required for the manufacturer to adjust its WIP inventory to its desired level
 DC = The desired cash: denotes the level of cash desired to be held by the manufacturer
 MCT = The manufacturing cycle time: represents the average delay time of the production process for the products from start until completion of the product

References

- [1] Spiegler VLM, Naim MM, Towill DR, Wikner J. A technique to develop simplified and linearised models of complex dynamic supply chain systems. *Eur J Oper Res* 2016;251:888–903.
- [2] Dias LS, Ierapetritou MG. From process control to supply chain management: an overview of integrated decision making strategies. *Comput Chem Eng* 2017;106: 826–35.
- [3] Hossain MR, Akhter F, Sultana MM. SMEs in covid-19 crisis and combating strategies: a systematic literature review (SLR) and A case from emerging economy. *Oper Res Perspect* 2022:100222.
- [4] Hofmann E, Templar S, Rogers DS, Choi TY, Leuschner R, Korde RY. Supply chain financing and pandemic: managing cash flows to keep firms and their value networks healthy. *Supply chain resilience*. Cham: Springer; 2023. p. 113–32.
- [5] Yousefi A, Pishvae MS. A fuzzy optimization approach to integration of physical and financial flows in a global supply chain under exchange rate uncertainty. *Int J Fuzzy Syst* 2018;20:2415–39.
- [6] Biglar A, Hamta N, Rad MA. A Mathematical Programming Approach to Supply Chain Network Design considering Shareholder Value Creation. *Discrete Dyn Nat Soc* 2022;2022.
- [7] Chauffour J-P, Malouche M. Trade finance during the great trade collapse. The World Bank; 2011.
- [8] Badakhshan E, Humphreys P, Maguire L, McIvor R. Using simulation-based system dynamics and genetic algorithms to reduce the cash flow bullwhip in the supply chain. *Int J Prod Res* 2020;58(17):5253–79.
- [9] Jiang W-H, Xu L, Chen Z-S, Govindan K, Chin K-S. Financing equilibrium in a capital constrained supply Chain: he impact of credit rating. *Transp Res Part E Logist Transp Rev* 2022;157:102559.
- [10] Razavian E, Tabriz AA, Zandieh M, Hamidzadeh MR. An integrated material-financial risk-averse resilient supply chain model with a real-world application. *Comput Ind Eng* 2021;161:107629.
- [11] Cardoso SR, Barbosa-Póvoa AP, Relvas S. Integrating financial risk measures into the design and planning of closed-loop supply chains. *Comput Chem Eng* 2016;85: 105–23. <https://doi.org/10.1016/j.compchemeng.2015.10.012>.
- [12] Longinidis P, Georgiadis MC. Integration of financial statement analysis in the optimal design of supply chain networks under demand uncertainty. *Int J Prod Econ* 2011;129:262–76.
- [13] Liu R, Xie X, Yu K, Hu Q. A survey on simulation optimization for the manufacturing system operation. *Int J Model Simul* 2018;38:116–27.
- [14] Xu J, Huang E, Hsieh L, Lee LH, Jia Q-S, Chen C-H. Simulation optimization in the era of Industrial 4.0 and the Industrial Internet. *J Simul* 2016;10:310–20.
- [15] Melo MT, Nickel S, Saldanha da Gama F. Dynamic multi-commodity capacitated facility location: a mathematical modeling framework for strategic supply chain planning. *Comput Oper Res* 2006;33:181–208. <https://doi.org/10.1016/j.cor.2004.07.005>.
- [16] Naraharsetti PK, Karimi IA, Srinivasan R. Supply chain redesign through optimal asset management and capital budgeting. *Comput Chem Eng* 2008;32:3153–69. <https://doi.org/10.1016/j.compchemeng.2008.05.008>.
- [17] Ramezani M, Kimiagari AM, Karimi B. Closed-loop supply chain network design: a financial approach. *Appl Math Model* 2014;38:4099–119. <https://doi.org/10.1016/j.apm.2014.02.004>.
- [18] Wolff M, Becker T, Walther G. Long-term design and analysis of renewable fuel supply chains—An integrated approach considering seasonal resource availability. *Eur J Oper Res* 2023;304(2):745–62.
- [19] Zhang Y, Liu S, Zhang X. An optimized supply chain network model based on modified genetic algorithm. *Chin J Electron* 2017;26:468–76.
- [20] Ivanov D. Simulation-based ripple effect modelling in the supply chain. *Int J Prod Res* 2017;55:2083–101.
- [21] Mele FD, Guillen G, Espuna A, Puigjaner L. A simulation-based optimization framework for parameter optimization of supply-chain networks. *Ind Eng Chem Res* 2006;45:3133–48.
- [22] Oliveira JB, Lima RS, Montevechi JAB. Perspectives and relationships in Supply Chain Simulation: a systematic literature review. *Simul Model Pract Theory* 2016; 62:166–91.
- [23] Utama DM, Santoso I, Hendrawan Y, Dania WAP. Integrated procurement-production inventory model in supply chain: a systematic review. *Oper Res Perspect* 2022:100221.
- [24] Puigjaner L, Lafnez JM. Capturing dynamics in integrated supply chain management. *Comput Chem Eng* 2008;32:2582–605.
- [25] Nickel S, Saldanha-da-Gama F, Ziegler H-P. A multi-stage stochastic supply network design problem with financial decisions and risk management. *Omega (Westport)* 2012;40:511–24. <https://doi.org/10.1016/j.omega.2011.09.006>.
- [26] Longinidis P, Georgiadis MC. Managing the trade-offs between financial performance and credit solvency in the optimal design of supply chain networks under economic uncertainty. *Comput Chem Eng* 2013;48:264–79.
- [27] Arani HV, Torabi SA. Integrated material-financial supply chain master planning under mixed uncertainty. *Inf Sci (Ny)*. 2018;423:96–114.
- [28] de Matta R. Product costing in the strategic formation of a supply chain. *Ann Oper Res* 2019;272:389–427.
- [29] Wang M, Huang H. The design of a flexible capital-constrained global supply chain by integrating operational and financial strategies. *Omega (Westport)* 2019;88: 40–62.
- [30] Albrecht W, Steinrücke M. Assessing site integration into semi-continuous production, distribution and liquidity planning of supply chain networks. *EURO J Transp Logist* 2020;9:100002.
- [31] Kalantari M, Pishvae MS, Yaghoubi S. A multi objective model integrating financial and material flow in supply chain master planning. *J Indus Manag Perspect* 2024;5(3, Autumn 2015):139–67.
- [32] Figueira G, Almada-Lobo B. Hybrid simulation-optimization methods: a taxonomy and discussion. *Simul Model Pract Theory* 2014;46:118–34.
- [33] Shanthikumar JG, Sargent RG. A unifying view of hybrid simulation/analytic models and modeling. *Oper Res* 1983;31:1030–52.
- [34] Abo-Hamad W, Arisha A. Simulation-optimisation methods in supply chain applications: a review. *Irish J Manag* 2011;30:95.
- [35] Afshar-Bakeshloo M, Bozorgi-Amiri A, Sajadi SM, Jolai F. A multi-objective Environmental Hedging Point Policy with customer satisfaction criteria. *J Clean Prod* 2018;179:478–94.
- [36] Chavez H, Castillo-Villar KK, Webb E. Development of the IBSAL-SimMOpt method for the optimization of quality in a corn stover supply chain. *Energies* 2017;10: 1137.
- [37] Chiadamrong N, Piyathanavong V. Optimal design of supply chain network under uncertainty environment using hybrid analytical and simulation modeling approach. *J Ind Eng Int* 2017;13:465–78.

- [38] Ding H, Benyoucef L, Xie X. Stochastic multi-objective production-distribution network design using simulation-based optimization. *Int J Prod Res* 2009;47: 479–505.
- [39] Frazzon EM, Albrecht A, Hurtado PA. Simulation-based optimization for the integrated scheduling of production and logistic systems. *IFAC-PapersOnLine* 2016;49:1050–5.
- [40] Liu H, Chu X, Xue D. An optimal concurrent product design and service planning approach through simulation-based evaluation considering the whole product life-cycle span. *Comput Ind* 2019;111:187–97.
- [41] Otamendi FJ, Doncel LM. Towards an auction-driven gas supply: a simulation-based optimization framework for utilities. *J Oper Res Soc* 2012;63:1189–98.
- [42] Wery J, Gaudreault J, Thomas A, Marier P. Simulation-optimisation based framework for Sales and Operations Planning taking into account new products opportunities in a co-production context. *Comput Ind* 2018;94:41–51.
- [43] Altazin E, Dauzère-Pères S, Ramond F, Tréfond S. A multi-objective optimization-simulation approach for real time rescheduling in dense railway systems. *Eur J Oper Res* 2020;286:662–72. <https://doi.org/10.1016/j.ejor.2020.03.034>.
- [44] Aslam T, Ng AHC. Combining system dynamics and multi-objective optimization with design space reduction. *Ind Manag Data Syst* 2016;116:291–321.
- [45] Chu Y, You F, Wassick JM, Agarwal A. Simulation-based optimization framework for multi-echelon inventory systems under uncertainty. *Comput Chem Eng* 2015; 73:1–16.
- [46] Duggan J. Using system dynamics and multiple objective optimization to support policy analysis for complex systems, in: *complex decision making*. Springer; 2008. p. 59–81.
- [47] Linnéusson G, Ng AHC, Aslam T. A hybrid simulation-based optimization framework supporting strategic maintenance development to improve production performance. *Eur J Oper Res* 2020;281:402–14. <https://doi.org/10.1016/j.ejor.2019.08.036>.
- [48] Peirleitner AJ, Altendorfer K, Felberbauer T. A simulation approach for multi-stage supply chain optimization to analyze real world transportation effects. In: *Winter Simulation Conference (WSC)*, 2016. IEEE; 2016. p. 2272–83.