

Physical representation of hillslope leaky barriers in 2D hydraulic models: A case study from the Calder Valley

Jake G. Senior¹  | Mark A. Trigg²  | Thomas Willis³ 

¹RPS Group and School of Civil Engineering, University of Leeds, GradCIWEM, Leeds, UK

²School of Civil Engineering, University of Leeds, MCIWEM, Leeds, UK

³School of Geography, University of Leeds, Leeds, UK

Correspondence

Jake G. Senior, RPS Group and School of Civil Engineering, University of Leeds, GradCIWEM, Leeds, UK.

Email: jake.senior@rpsgroup.com

Funding information

Natural Environment Research Council, Grant/Award Number: NE/P011160/1; Yorkshire Integrated Catchment Solutions Programme

Abstract

The resources of small-scale community-based flood risk action groups are often limited, hence studies to model and predict the effects of Natural Flood Management are often restrained by time and lack of empirical data to validate results. As a result, representations of hillslope leaky barriers are largely modelled as several equifinal approaches, often without survey data. The geometrical characteristics of hillslope leaky barriers were surveyed for the first time at Hardcastle Crags, Calder Valley. This data informed six 2D hydraulic model representation scenarios with varying combinations of topography modification and roughness increase, allowing the sensitivity of their results to be tested. Results from Scenario 3 (topography modification and roughness increase) estimated total hillslope runoff peak flow to reduce by 16.6% in a 1:1-year design return period; however, this reduction diminished as rainfall intensity increased. Return periods of over 1:30 year estimated peak flow reductions of <5%. Only 14.3%–21.7% (98–148 m³) of the total additional storage provided by the barriers is mobilised during simulated events. A multi-peaked rainfall event from December 2015 was also simulated. Although the initial peak flow was reduced by 22.7%, as storage became mobilised, effectiveness reduced significantly for subsequent peaks within the same event.

KEYWORDS

flood risk, HEC-RAS, hillslope, hydraulic modelling, leaky barriers, Natural Flood Management

1 | INTRODUCTION

Over the past decade, many UK communities have experienced more intense and frequent fluvial flooding incidents (Thompson et al., 2017). Consequently, some communities have lost confidence in traditional Flood Alleviation Schemes and have mobilised themselves to increase their local catchments resilience to flood risk (Dadson et al., 2017; Howgate & Kenyon, 2008). A

popular and accessible technique available to these community groups has been Natural Flood Management (NFM). This concept aims to use natural resources and enhance natural processes to slow and store water across whole catchments (Rasche et al., 2019; Sørensen et al., 2016). This approach aims to reduce peak overland flow draining through a watershed, reducing the risk of flooding to downstream urbanised communities.

This is an open access article under the terms of the [Creative Commons Attribution](https://creativecommons.org/licenses/by/4.0/) License, which permits use, distribution and reproduction in any medium, provided the original work is properly cited.

© 2022 The Authors. *Journal of Flood Risk Management* published by Chartered Institution of Water and Environmental Management and John Wiley & Sons Ltd.

Due to the small-scale operation of these community-based flood management groups, their budgets and resources are often limited (Wells et al., 2020). Therefore, when determining the effectiveness of a project, a lack of funding incentives causes land managers to opt for cheap monitoring technology over computational modelling (Dixon et al., 2016). As a result, representations of hillside leaky barriers are largely modelled without survey data or a standardised method (Addy & Wilkinson, 2019). There is hence a need to develop an efficient method to accurately model hillslope leaky barriers.

1.1 | Current modelling approaches

The effect of leaky barriers is inherently uncertain, as they are subject to variables like event and catchment scale, soil/ land use, build quality and so on (Black et al., 2021; Pinto et al., 2019). The variable parameters of NFM sites have therefore prevented existing empirical data on leaky barrier effectiveness from being defined in standardised metrics (e.g. X barriers have Y effect on river peak flow/volume stored) (Salazar et al., 2012).

Each NFM scheme must therefore be analysed on a site-by-site basis to ascertain leaky barrier effectiveness with increased confidence. A common method to understand the overall effects of multiple barriers is through hydraulic modelling. 2D hydraulic models use digital elevation models (DEMs) to create the topographic mesh surface as a baseline, in which leaky barriers are represented on this surface in some physical form.

Conceptually, a leaky barrier forms a small dam, behind which water is stored during a runoff event. Depending on the leakiness of the barrier, water is also continually draining from the storage (Metcalf et al., 2018). The effectiveness of the leaky barrier is therefore a function of the duration and magnitude of inflow to the storage area, the volume of the storage area and the leakiness of the dam wall. As these structures are rarely “designed” in terms of storage and leakiness, there is a large uncertainty, not only in their individual parameters, but also in how to represent these structures in a hydraulic model (Abbe, 2006; Cabaneros et al., 2018; Liu et al., 2004). Currently, there is no standardised/ industry recognised method of representing hillside leaky barriers in 2D hydraulic models.

Addy and Wilkinson (2019) summarises that there are three core techniques, used in isolation or combination, to represent leaky barriers. These include (A) Adjusting geometry: Creating physical obstructions and depressions in the 2D mesh, (B) Adjusting roughness: Isolated changes to Manning’s “n” to cause flow to

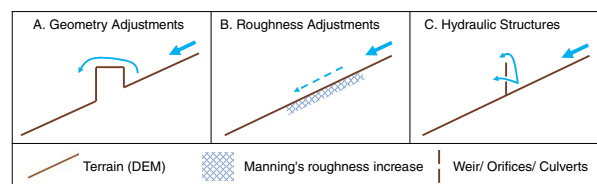

FIGURE 1 The three general techniques used to represent leaky barriers in hydraulic models

slow, and (C) Using hydraulic structure tools: Integration of 1D links like weirs, culverts, orifices, and permeable walls (Figure 1).

Addy and Wilkinson hence describe modelling of leaky barriers to be equifinal, as multiple representations can be used to achieve the same means. Also, a lack of empirical validation data does not currently allow modellers to determine which representation is the most realistic. The sensitivity in results of the stated representations should therefore be tested together to better understand their relative impact on results.

1.2 | Research gap

In this study, we have developed six different combinations of Category A—“geometry adjustments” and Category B—“roughness adjustments” to represent leaky barriers in existing hydraulic modelling software, specifically using HEC-RAS 2D, but representative of other 2D models used in industry. We use Hardcastle Crags, Calder Valley, as a study site due to its mature implementation of several hundred leaky barriers as part of Slow the Flow Calderdale’s NFM projects.

A rapid assessment method to collect on-site leaky barrier data was developed and applied to capture the geometry of the individual barriers. Leaky barrier storage volumes and event volumes are tested for a range of return period rainfall from the *Flood Estimation Handbook* and gauged rain data from an event for 26 December 2015. The rainfall event on this day caused major flooding in downstream settlements, initiating the Hardcastle Crags NFM programme. Although both in-channel watercourse barriers and hillslope barriers are implemented at the site, only the hillslope barriers have been considered in this study.

Our overall aims in this paper are to: (i) develop a rapid survey method to collect basic leaky barrier parameters efficiently; (ii) explore the sensitivity of different physical model representations required of hillslope leaky barriers on model results; and (iii) provide insight into the effectiveness of the sampled leaky barriers at the Hardcastle Crags site.

2 | STUDY SITE

2.1 | Location

Slow the Flow Calderdale are a community-based organisation situated in the Calder Valley (UK), working in association with *National Trust*. They have piloted several mature implementations of NFM. At their Hardcastle Crags site, their chosen intervention is predominantly the leaky barrier made from fallen tree debris. These barriers act as runoff attenuation features, aiming to slow and store hillside runoff in the upland catchment to reduce downstream peak flows and flooding (Abbe & Montgomery, 1996; Cashman et al., 2019).

Hardcastle Crags contains a diverse spread of leaky barrier designs. Barriers can be categorised by the type of flow path they are located in. “Watercourse barriers” are placed in Hebden Beck itself, hence interacting with regular inflow. “Hillside barriers” are placed in the ephemeral channels of the watercourse’s wider catchment. These channels are often empty in dry weather, however, they become concentrated flow paths for runoff during storm events. This paper solely focuses on the latter. In

theory, these hillslope measures reduce the peak overland flow draining into a receiving watercourse.

Hebden Bridge is a town within the Upper Calder Valley catchment of West Yorkshire, UK. Hebden Beck flows through the centre of Hebden Bridge before draining into the River Calder, south of the town. Along with other watercourses in the area, peak flows in this watercourse have been responsible for three major flooding events in the past 10 years: 2012, 2015 and 2020 (Eye on Calderdale, 2021). The topography of the upstream catchment is very steep, with average gradients of over 15% next to the Beck. This gradient causes rainfall to drain into the Beck very quickly. The stage height of the Beck is therefore very reactive to rainfall, causing flash flooding. Notably, on Boxing Day of 2015, Storm Eva caused Hebden Beck to rise 3.5 m above its usual peak. This contributed to large areas of the town centre being more than a metre under water.

2.2 | NFM interventions

Hardcastle Crags is a woodland National Trust site, 2 km north of Hebden Bridge. Hebden Beck flows through the

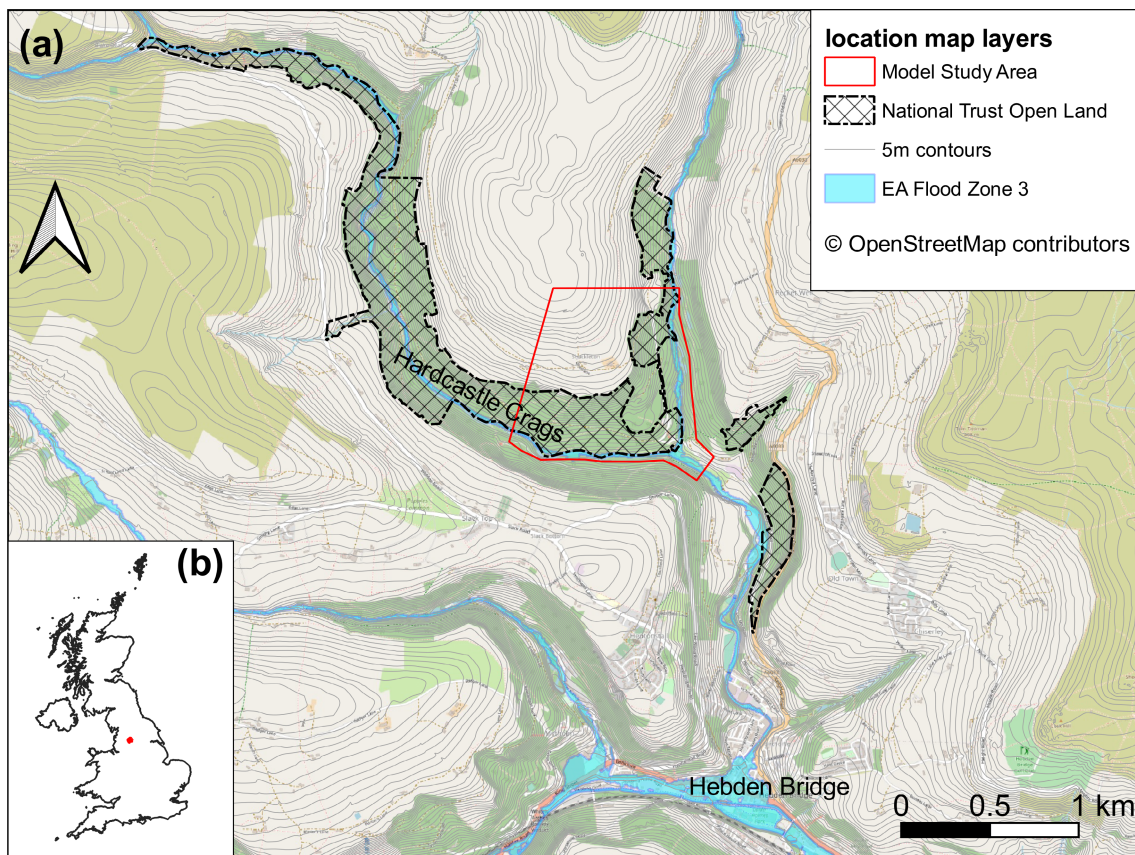

FIGURE 2 Study site location relative to Hebden Bridge, showing National Trust open land and EA Flood Zone 3 (elevation range within study area: 140–340 m)

centre of Hardcastle Crags before entering the town (Figure 2). Slow the Flow Calderdale are a community based NFM Organisation that used the 2015 flood as a stimulus to implement over 600 leaky barriers (as of October 2021) (Slow the Flow, 2021). Dense woodland stretches across this site and provides a wide range of woody debris to build the barrier structures. This NFM programme is a dense, varied and mature example of leaky barrier implementation, making it the ideal case study to collect data to inform the model representation scenarios.

3 | METHODS

The methodology can be divided into four stages (Figure 3). First, the site surveying of leaky barriers to accurately represent their location, size and orientation (using a Leica Zeno 20). Second, creating the baseline model build using a DEM with an appropriate hydraulic domain boundary to represent a scenario without NFM interventions. Third, using this baseline DEM and survey data, barriers are hydraulically represented with six different approaches. Last, suitable net rainfall

inputs must be determined to provide a realistic over-land flow through each of the models. The hydrographs from each model are recorded at an “exit boundary”, just before the receiving watercourse. Hydrographs from this boundary then allow comparisons between peak flow and volume from each hillslope barrier representation. The methodology used is summarised here but is provided in more detail in the Supporting Information.

In addition to analysing the sensitivity in peak flow and volume of each barrier representation, we suggest a method for understanding the efficiency of the storage provided by the barriers. We define this as the “fullness”, which is the proportion of storage that is active during a simulation, compared to the theoretical maximum volume.

Chappell (2020) suggested that an Environment Agency Flood Alleviation Scheme hard engineering flooding intervention is designed to store 10,000 m³/km². Although it is not suggested to be a rule of thumb for NFM interventions (as NFM is not intended as a replacement to current engineering strategies), this storage parameter provides a useful benchmark for comparison purposes.

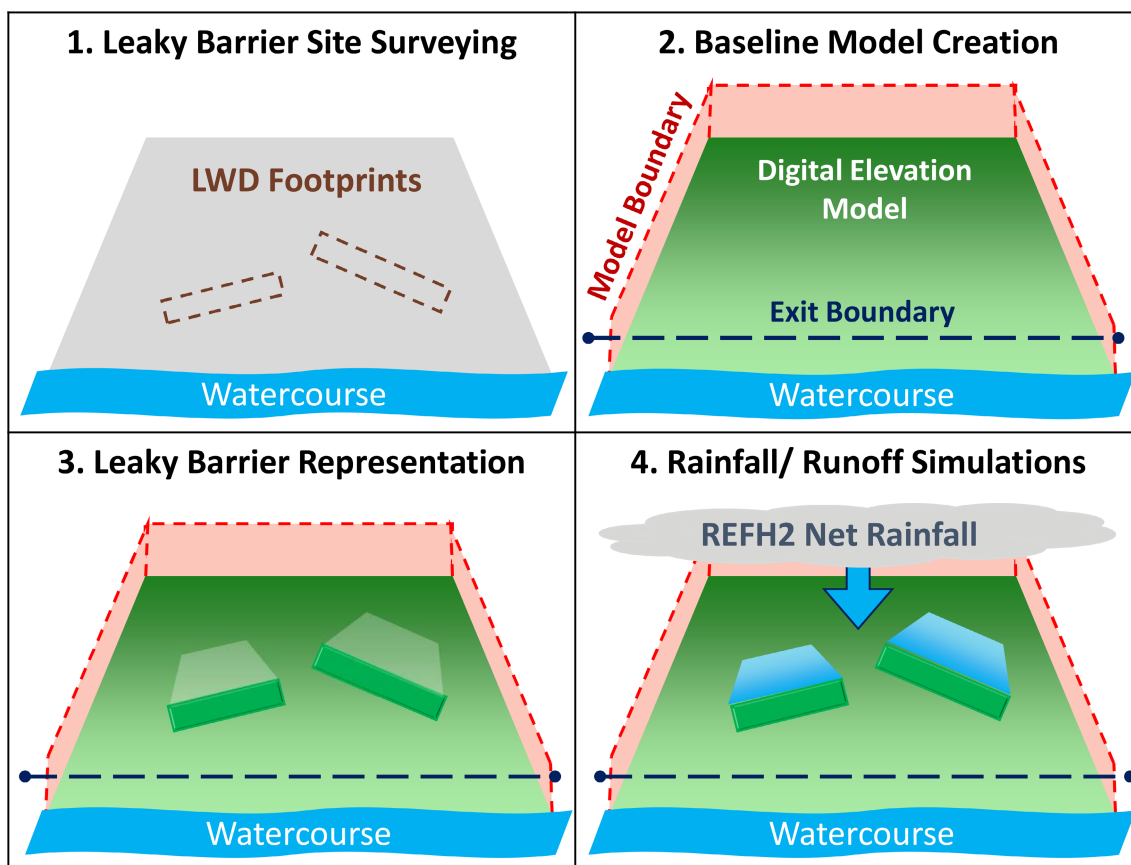

FIGURE 3 A schematic of the four stages of the methodology

3.1 | Leaky barriers survey

To model the barrier structures accurately, we used accessible survey technology to collect geospatial and dimensional data to provide a blueprint for hydraulic representation. At the time of surveying (June 2019), we surveyed 93 structures in the densest region of the site. The footprints of the barriers are shown as black outlined polygons in Figure 4.

3.2 | Hydrological modelling methods

Estimated net design rainfall was used as the input to the hydraulic model and applied with a spatially uniform “rain on grid” approach. ReFH2 was used to estimate a “net rainfall” hyetograph for the input boundary condition, using the Flood Estimation Handbook (CEH, 1999) catchment descriptors specific to the area of Hardcastle Crags (Kjeldsen et al., 2005). The resulting net rainfall is therefore the proportion of rainfall that would flow overland down the hillslope. This approach avoids needing to account explicitly for other hydrological losses (e.g. infiltration) in the hydraulic model. A 3-h duration event, with a 9-h simulation time was used as this allowed the runoff hydrograph to peak and for overland flow to return to near zero levels at the outflow. Eight return periods were considered in this study (1, 2, 5, 10, 30, 50, 75 and 100). In addition, the Boxing Day 2015

event was also modelled from rainfall gauge data processed through ReFH2 to provide net rainfall. The 2015 event caused considerable damage throughout the Upper Calder catchment, with a 24-h rainfall amount that exceeded the 50-year return period for 3 of the 8 rainfall gauges in the area (Calderdale Council, 2017).

3.3 | Hydraulic modelling methods

The hydraulic modelling software applied in this study was HEC-RAS v5.07. HEC-RAS's ability to implement nested meshing levels, sub-grid topography and enforce breaklines on the 2D mesh also give us flexibility in terms of how we represent the leaky barriers physically within the model. Other 2D solvers (including LISFLOOD-FP) were used to compare model stability due to high gradients in the catchment. HEC-RAS 2D was comparatively more stable due to an adaptive timestep and small mesh size.

A baseline model of the hillslope without any leaky barriers was constructed with the UK Ordnance Survey 5-m national digital elevation model (bare earth DEM), as no LiDAR DEM is currently available for the location. Five-meter DEM resolution risks losing some channel definition, modifying the DEM to represent leaky barrier storage is considered model build (Ferguson & Fenner, 2020). Drainage analysis was used to delineate the boundary of the hillslope catchment draining through

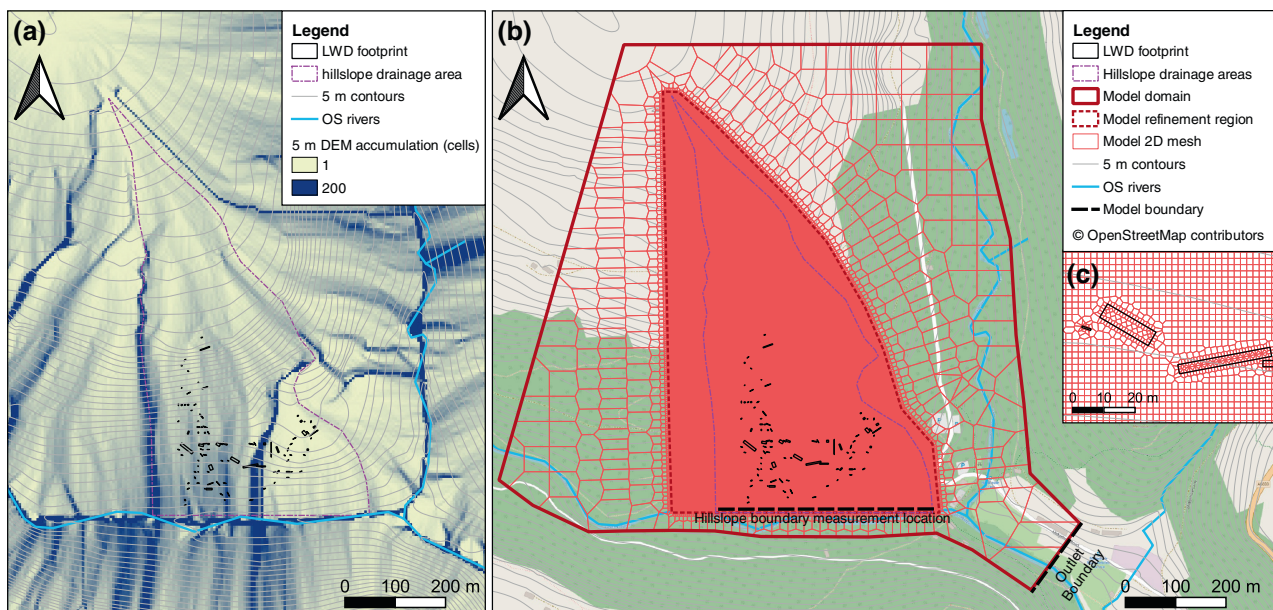

FIGURE 4 Model schematic (a) digital elevation model drainage analysis results and identified hillslope drainage area; (b) model layout, showing outer domain boundary (50 m mesh), inner refinement region (2 m mesh), domain outlet boundary, and internal measurement boundary at base of hillslope; (c) zoomed in area showing mesh detail around leaky barriers

the leaky barrier study area covering 201,151 m² (Figure 4a). A model output location along the bottom of the hillslope was defined with a profile line to enable the extraction of a hydrograph representing the cumulative runoff from the entire hillslope (Figure 4b).

The final baseline model (Figure 4b) is composed of an outer domain meshed at a 50-m resolution and encompasses a much larger area (890,505 m²) than the study area (201,151 m²) to allow for inclusion of the natural river drainage (represented by the topography of the 2D DEM only) out of the domain on both sides of the hill. The study area used a mesh size of 2 m and the underlying DEM has a resampled resolution of 0.5 m (red region, Figure 4b) to allow even the smallest leaky barriers to be represented in the DEM. The footprints of the leaky barriers were applied as breaklines on the baseline mesh so their physical shapes are present explicitly in the irregular model mesh, including the baseline model. The diffusive solver was used for all model runs.

Research shows that friction values increase under both shallow flow (Diaz, 2005) and steep slope conditions (Hessel et al., 2003). Both conditions are present in this case study, so a Manning's n friction of 0.2 is used, based on the 30% slope and typical flow depths of <0.25 m.

3.3.1 | Model build—structural representations

One of the aims of this research was to understand the sensitivity of results from multiple equifinal approaches to represent hillside leaky barriers in 2D hydraulic models.

Following the approaches summarised by Addy and Wilkinson (2019), six approaches for representing leaky barriers were constructed and evaluated. All of the six approaches are based on modification to the geometry of the 0.5 m DEM underlying the 2-m model mesh, and/or a local increase in the roughness value, also applied at a 0.5-m raster cell size. An irregular mesh was also used to allow for a more refined cell size around the footprint of the barriers to sufficiently represent the small features (shown in Figure 4c). For approaches that apply a roughness adjustment, a Manning's n value of 0.5 was used, higher than the general hillslope friction value of 0.2. The approaches are summarised below and shown in Figure 5.

Tested model build structural representations:

S1—td_pit—geometric; barriers represented as a “dam”—the DEM cells in the footprint of the barrier have been increased to the height of the structure. The region behind the barrier is represented as a “pit”—the cells in the footprint of the theoretical storage area of the dam is lowered to match the elevation from the bottom of the structure.

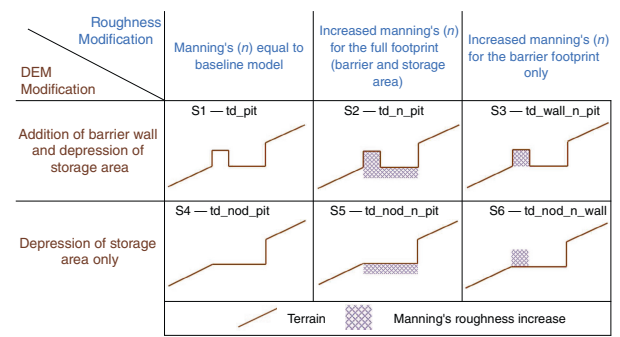

FIGURE 5 A schematic diagram of each tested model build scenarios, including various combinations of geometry (terrain) adjustment and/or roughness adjustment

S2—td_n_pit—geometry and roughness; the geometry from the S1 model is used in conjunction with an increased roughness (0.5) in both the footprint of the dam and the pit.

S3—td_wall_n_pit—geometry and roughness; the geometry from the S1 model is used in conjunction with an increased roughness (0.5) in the footprint of the dam only. The roughness of the pit is the default value of 0.2.

S4—td_nod_pit—geometry; barriers represented only as a pit. The elevation of the pit is determined from the same approach as S1 and is applied to both the footprint of the structure and the region behind it.

S5—td_nod_n_pit—geometry and roughness; the geometry from S4 is applied with an increased roughness value (0.5) in the footprint of the barrier and pit.

S6—td_nod_n_wall—geometry and roughness; the geometry is applied with an increased roughness value (0.5) in the footprint of the barrier only. The roughness of the pit is the default value of 0.2.

3.4 | Leaky barrier storage efficiency

Leaky barrier storage efficiency is defined as the percentage of volume that is predicted to be stored by barriers in a rainfall event compared to the theoretical maximum storage (based on volumetric calculations conducted in GIS) that is provided by the barrier and area behind it. This is defined in Equation (1).

$$\text{Storage Efficiency Percentage} = 100 \left(\frac{S_e}{S_m} \right), \quad (1)$$

where S_e and S_m are the storage volume behind the barrier in m³ during the event and the theoretical maximum possible, respectively.

Leaky barrier storage capacity may not entirely fill due to several reasons. First, if not placed directly in the main line of drainage, the inflow may not be sufficient to

fill the storage. Second, due to build characteristics like the orientation on the hillside, a barrier may overflow or be bypassed before being completely filled.

The leaky barrier representations are polarised in terms of how they represent leakiness. Roughness changes only slow flow, without any additional storage, hence providing 100% leakiness. However, geometry modifications produce an impervious block on the DEM which creates storage areas with no leakiness. The impervious barrier approach may overestimate the effectiveness of structures, particularly before the storage areas are filled. Therefore, we attempt to quantify a theoretical maximum storage for each barrier and calibrate this theoretical method with a field-based measurement of a sample of barriers, described in the following sections.

3.4.1 | Theoretical maximum storage

A zone of influence (ZOI) was drawn behind each leaky barrier, to represent the area which could likely store a volume of overland flow. A triangular polygon was drawn behind each barrier. The reach point, shown in Figure 6, is the backwater limit of the dam storage. This is assumed to be where the elevation of the hillside behind a barrier, derived from the DEM, is equal to the height of the barrier. This process was carried out for all the barriers using automated GIS methods. A pyramid volume formula was used calculate the estimated theoretical max storage behind each barrier, using the barrier face height and width measurements as the pyramid base, and the reach point as the pyramid height (Figure 6).

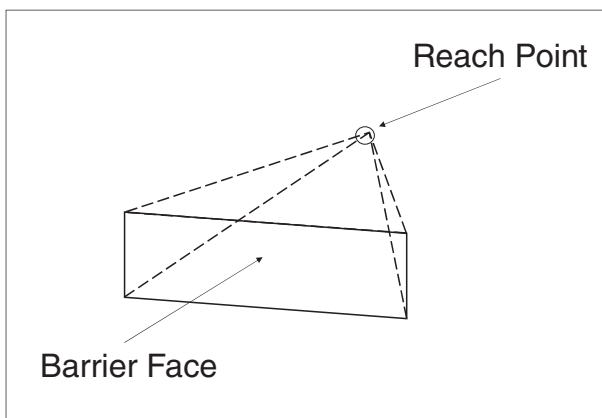

FIGURE 6 Illustration of the volume calculated from the barrier face and reach point measurements (ZOI). Flow direction from reach point to barrier face. ZOI, zone of influence

$$\text{Theoretical Storage (Pyramid Volume)} = \frac{\text{Barrier Face Area} \times \text{Distance to Reach Point}}{3} \quad (2)$$

3.4.2 | Surveyed maximum storage

The reach point of 19 barriers were surveyed to understand the accuracy of the GIS-based calculations. This was achieved by attaching a piece of string to the centre of a barrier at its top and pulling this string out, while ensuring it is level with a spirit level, to meet the hill-slope behind the barrier at the same elevation. The length of the string between the barrier and the hillslope

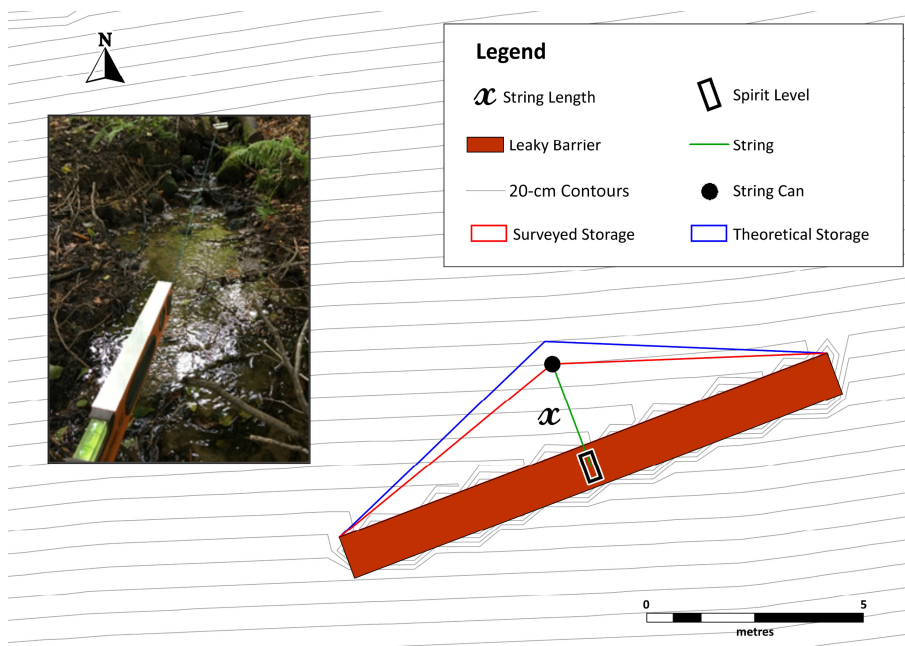

FIGURE 7 An annotated plan view representing the storage surveying method (right), coupled with an on-site photo (left)

was then measured to provide the surveyed ZOI (Figure 7).

The ZOIs drawn from this on-site field method were on average 15.8% lower than the GIS-based method ZOIs. This provides a weighting to adjust the GIS-based max storage of the barriers, that is, a “calibrated max storage”.

4 | RESULTS

4.1 | Baseline results and selection of structure representation

The hillslope runoff hydrograph for the baseline results is shown Figure 8, together with the ReFH2 calculated runoff (no baseflow) for the same area for comparison. Peak runoff ranges from 0.12 to 0.78 m³/s, for the 1:1 year to the 1:100 year event, respectively. ReFH2 estimates peaks of 0.13 to 0.54 m³/s, respectively.

The hillslope runoff hydrograph for the 1:1-year event was extracted from all the model runs, baseline and six structural representations and shown in Figure 9. This is the only return period analysed for all representations.

The ReFH2 lumped hydrology modelled runoff provides an interesting comparison for the rain on grid hydraulic method for the baseline HEC-RAS model. We would not expect these hydrographs to be identical, as neither is calibrated. The hydraulic model shows a double peak due to the two slope areas that contribute to the bottom of the hillslope at slightly different times. This is not represented in the lumped ReFH2 model, which is much simpler compared to the distributed runoff rain on grid model. The hydraulic model also shows a sharper earlier peak which may be more realistic on this relatively steep terrain, but the timing will be sensitive to the choice of Manning's n for the slope.

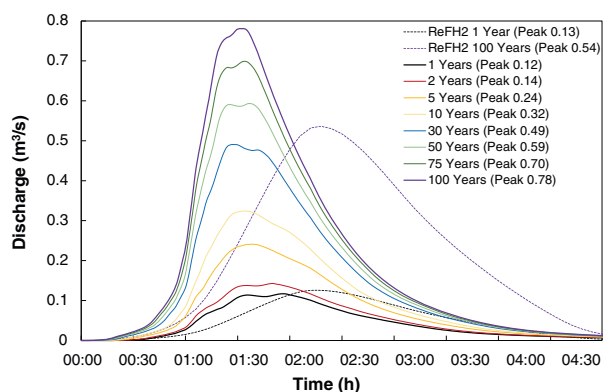

FIGURE 8 Hillslope hydrographs from baseline model for all event return periods. ReFH2 runoff hydrograph (no baseflow) also shown for 1:1- and 1:100-year return periods for comparison

All the structural representation methods show a reduction in peak flows and therefore are affecting the runoff, as expected. There was only a modest change to the timing of the peak flow ranging from 5–10 min. There is no one particular method which could be described as correct and they all appear to modify the hydrograph shape in a similar way, but with slightly varying magnitudes of impact. There is a reduction in peak flow of between 8.0% and 21.1% depending on the leaky barrier structural representation. Unsurprisingly, the lowest reduction is from S4, which has only the pit with no wall and no increase in friction, and the biggest reduction in peak flow is from S2, the representation that uses a pit, wall and increased friction for both. At the end of a 9-h model run, the water that remains behind the barriers is 60, 68 and 61 m³ for the S1, S2 and S3 scenarios (with wall) and is 27, 33 and 31 m³ for the S4, S5 and S6 scenarios (without wall). The difference in volume retained shows that the solid wall helps retain more water but may not allow full drainage as would probably be experienced in reality.

For further results analysis, we report only the results for the “S3: Wall_n_Pit” representation for clarity. We chose S3, as without further validation or verification data, it is difficult to know which representation may be closest to reality, and we feel S3 represents a sensible mid-impact approach, with some representation of both storage and leakiness.

4.2 | Design rainfall events

The full series of design rainfall events, derived using REFH2, were simulated with the “S3: Wall_n_Pit” model build scenario and the baseline model. Figure 10 illustrates how the modelled leaky barrier representation

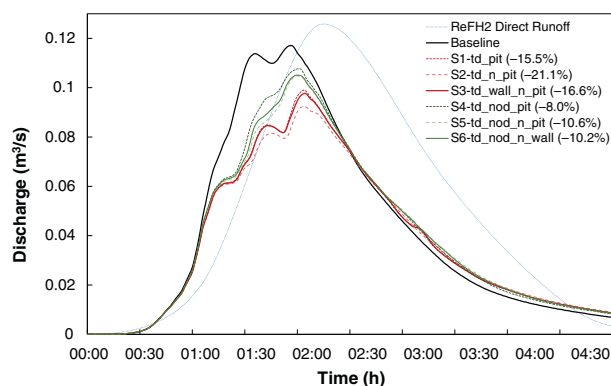

FIGURE 9 Hillslope hydrographs resulting from each tested leaky barrier modelling structure for a 1:1-year return period. Percentage reduction in peak flow shown in brackets

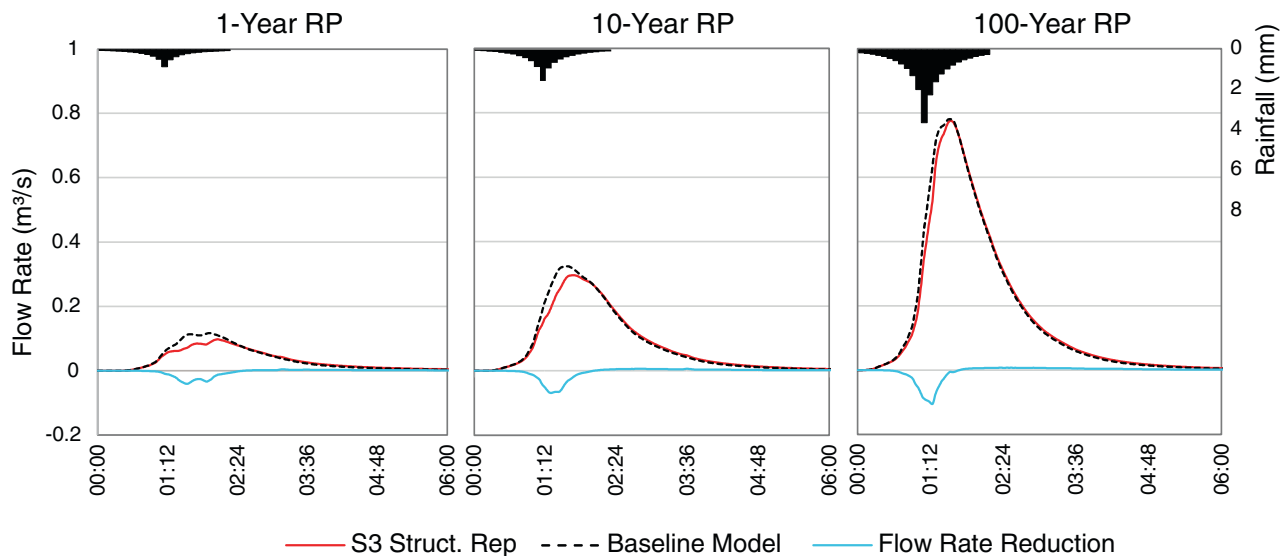

FIGURE 10 Hydrographs showing the change in flow rate into the watercourse as a result of the barrier (left Y-axis) and the rainfall in mm per 15-min interval (right Y-axis) from the 1:1-, 1:10-, 1:100-year design simulations, using the S3 scenario

TABLE 1 Percentage of event volume stored by barriers and resultant reduction in peak flow for each simulated design rainfall return period (RP) across total events

RP (1: year)	Peak flow reduction (l/s)	% Reduction in peak flow	Event volume stored by leaky barriers (m ³)	% of event volume stored by leaky barriers
1	19	16.6	98.3	10.7
2	22	15.3	104.3	9.8
5	28	11.4	118.3	7.6
10	28	8.5	126.4	6.5
30	22	4.4	137.6	5.0
50	10	1.6	143.0	4.5
75	7	1.1	146.3	4.1
100	5	0.7	148.3	3.8

have affected overland flow in terms of both volume stored and peak flow discharged into the watercourse from the study area hillslope. All measurements are taken from a profile line at the base of the hillslope, just before entry into Hebden Beck.

In lower magnitude storms, the modelled leaky barrier representations store a high proportion of the overland flow. Table 1 shows that during the most common rainfall events (RP <1:5 years), the reduction of peak discharge to the watercourse is consistently above 10%.

However, as the magnitude of overland flow increases in larger rainfall events, results show that the barriers store proportionally less of the total event volume. The subsequent effect in peak flow entering the watercourse, though still evident, is reduced. This diminishing effectiveness of the leaky barriers is illustrated in Figure 11. Each dam has limited storage capacity, hence with

increasing volumes of runoff, the barriers can store proportionally less of an event.

These results suggest that the structures are most effective during smaller storms (RP <1:5 years), which have a lower contribution to extreme downstream flood risk.

4.3 | Real rainfall event

A simulation was then run using rainfall data from 26 December 2015 to 28 December 2015. Rainfall during this period was responsible for catastrophic flooding in the Calder Valley, and provided the stimulus for the implementation of the leaky barriers modelled in this paper. The rainfall event was multi-peaked, with the maximum observed flow rate equivalent only to

approximately a 1:10-year design rainfall event (Figure 12). This storm, however, persisted at moderate intensity over a significant duration, starting on Boxing Day morning with 26 h of almost continuous rainfall. Effectiveness of the barriers can therefore be understood with increasing saturation.

At Peak 1a, as shown in Table 2, the peak flow is predicted to reduce by 22.7%, consistent with the benefits identified in the design storm simulations. However, this is followed by a significant decline in effectiveness with increasing rainfall intensity. During Peak 1c, the volume stored by the leaky barriers became negative, with a small amount more flow being discharged from the S3 model than the baseline in same period. This is due to the release of water stored from the initial rainfall peaks

draining from the model, suggesting the hillslope leaky barriers lose effectiveness due to the model becoming saturated. This may be partly explained by the model representation not providing sufficient “leakiness” to allow water to drain through the barrier, as it may do in reality.

4.4 | Leaky barrier storage efficiency

The leaky barriers GIS-based theoretical maximum storage volume summed to 813 m³. With a reduction of 15.8%, based on survey data, this would give a calibrated max storage of 684 m³ across the 0.201 km² study site (3405 m³/km²). The total event volume stored by leaky barriers during the model simulations (98–148 m³) equate to just 14.3%–21.7% of the calibrated max storage.

A typical Flood Alleviation Scheme aims to store around 10,000 m³ of flood water per km² of catchment,

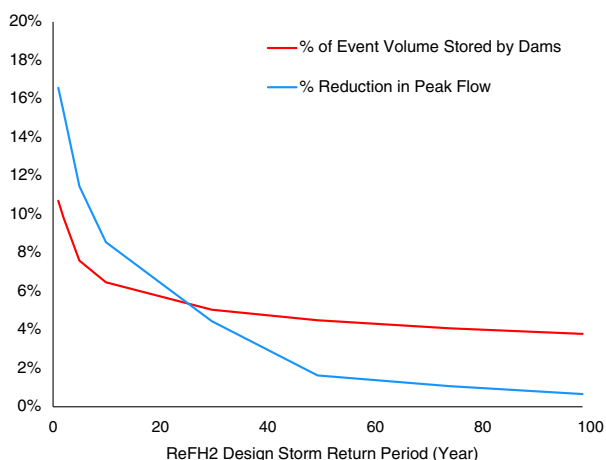

FIGURE 11 Relative effectiveness of the leaky barriers in reducing peak flow and storing water volume across increasing design rainfall events, using the S3 scenario

TABLE 2 Percentage of event volume stored by barriers and resultant reduction in peak flow at each sub-peak of the December 2015 simulation, across full event

Peak	Sub-peak	% of event volume stored by leaky barriers	% reduction in peak flow
1	1a	22.7	17.6
	1b	4.9	5.1
	1c	-0.9	0.6
2	2a	-2.3	-1.6
	2b	-0.3	-1.7
	2c	1.3	-0.9
3	3	0.7	0.0

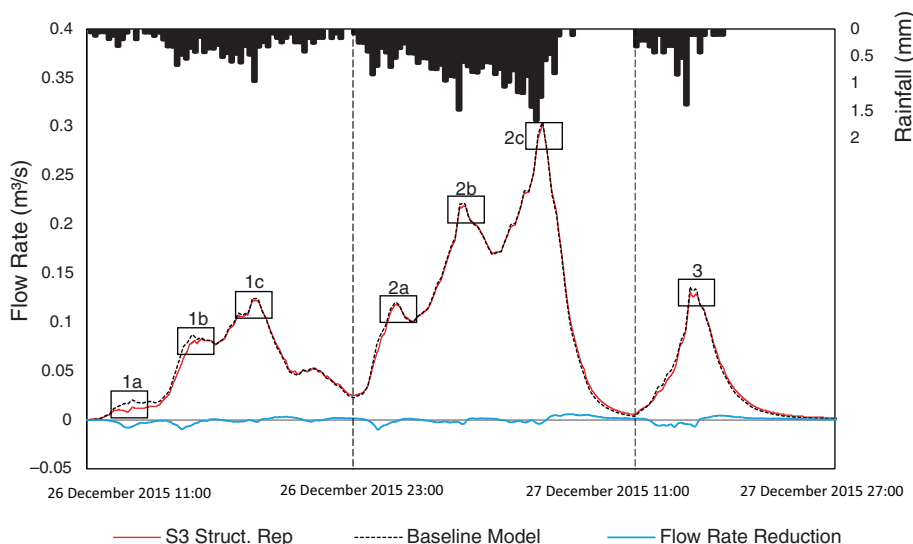

FIGURE 12 Hydrograph showing the change in flow rate into the watercourse as a result of the barriers and the rainfall in mm per 15 min from the December 2015 simulations

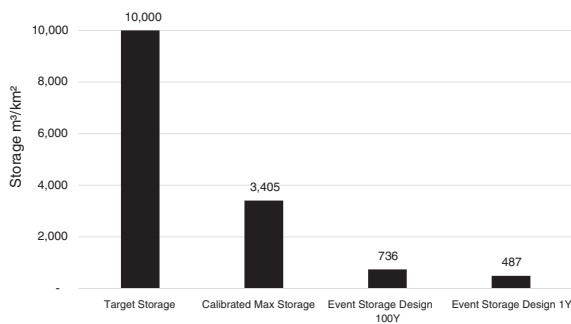

FIGURE 13 A bar chart showing max storage and range of event storages normalised from the 0.20115 km² drainage catchment to m³/km². Comparison with target volume of an Environment Agency Flood Alleviation scheme.

providing a “target storage” for comparison purposes. The calibrated max storage for this study site is approximately a third of the target storage at. Hypothetically, if the only flood defence used in this area were leaky barriers, the density would have to be tripled to have the equivalent effect of a typical hard engineered intervention for the same area. Values are shown in Figure 13.

Leaky barriers, however, can be implemented in rural areas of catchments where “grey infrastructure” cannot, hence providing additive value to a flood alleviation scheme. Enhancements to catchment storage like this could potentially provide climate-proofing to allow current flood risk management infrastructure to continue to perform to design standards.

5 | DISCUSSION

5.1 | Model sensitivity

In this paper we have run the six different models, representing leaky barriers with variations of DEM modification and roughness. The running of these different models is a sensitivity test and exploration of the range of predictions.

These representations were parametrised using detailed survey data of multiple leaky barriers in a small catchment. The running of these different models is a sensitivity test to explore the range of results. The peak flow reductions between these different models varied between 8.0% and 21.1% (1:1-year return period). If this range was smaller, it could be concluded that all representations would be equally appropriate for analysing impacts of the barriers. However, to ascertain which is “true”, further research into a method to monitor overland flow may be necessary to be able to recommend a single representation. Although the true extent of the

effect cannot be concluded, all six representations predicted a reduction in peak flow.

5.2 | Hillside leaky barrier effectiveness

Where the leaky barriers at Hardcastle Craggs are located on the hillside above the receiving watercourse, overland flow is distributed across a large area in a low concentration. Therefore, the storage efficiency of the barriers is understandably limited, as they rely on sufficient upstream area to provide inflow to fill the storage. However, it is with credit to *Slow the Flow Calderdale* that the density of barriers across this catchment is such that a significant reduction to peak inflows to Hebden Beck is predicted to occur during all rainfall events. Effectiveness, however, declines with increasing rainfall intensity, especially during return periods of over 1:5 years. These results are in-line with other studies which have modelled the effect of volume retaining NFM interventions (Ramsbottom et al., 2019; Samra, 2017).

Samra (2017) also provides evidence to suggest that in-channel leaky barriers built in larger watercourse (like Hebden Beck) have the converse relationship, showing increased effectiveness with rainfall intensity. This may be due to in-channel river barriers interaction with greater, more concentrated flows than the hillslope barriers.

5.3 | Storage implications

The comparison between the leaky barriers calibrated maximum storage and the simulated event storage suggested that only 14.3%–21.7% of the available storage was being mobilised, depending on return period. Overland flow hence does not provide a significant inflow to fill these micro-reservoirs and subsequently many hillside leaky barriers are necessary to make a significant impact. It is projected that the intensity of UK rainfall events may increase by ~10%–40% due of climate change (Garner et al., 2017). This case study shows the barrier's storage effect could help to mitigate the impacts of climate change. Ultimately, the storage benefit will depend on the build characteristics of the leaky barriers, amongst other factors. However, they may play a role in preventing current hard engineered flood alleviation measures from becoming overwhelmed.

5.4 | Scope for further development

This study has shown that equifinal approaches to represent the same leaky barriers in hydraulic models can

produce variable peak flow reduction results. This provides sufficient evidence that a method to validate flows is necessary to determine which representation method is the most accurate. Flow monitoring in this area of catchments is, however, very challenging (Ndomba, 2014). First, flows in ephemeral channels and storage areas produce measurement readings with instabilities due to low depths. Second, leaky barriers are generally implemented in environments with high amounts of vegetation/debris. Hence, water depth readings may be affected by other materials. Further research into a feasible flow survey method to validate flows across a site with many barriers may therefore be required.

Leaky barriers were modelled by increasing roughness in the barrier footprint or creating impenetrable blocks on a DEM. However, leaky barriers inherently “leak” flow. Furthermore, site observations (summarised in the Supporting Information section), suggest that 38% of surveyed barriers were not connected to the hillside across the full length of the barrier. The dynamics of how these leaks affect the event storage inflows and outflows are unrepresented. Moreover, the nature of the heterogenic building materials causes the extent of barrier leakage to be variable from structure to structure. An efficient method to determine individual leakage and subsequent hydraulic representation of leaky barriers hence requires further research.

Soil saturation and infiltration are only considered implicitly through the ReFH2 losses calculation in this study. One of the aims of Slow the Flow Calderdale is to design hillside leaky barriers which forces flow to spill out of ephemeral channels and onto adjacent land. This allows greater opportunity for flow to infiltrate into the soil instead of being directed in channels to the watercourse. This process was, however, not represented explicitly in this hydraulic modelling.

6 | CONCLUSIONS

The purpose of this study was to compare six equifinal methods of representing hillside leaky barriers in hydraulic models (with DEM geometry and roughness alterations). To ensure these methods were best-informed, we carried out a rapid site survey of 93 hillside leaky barriers at Hardcastle Crags, UK. The method used accessible technology to geolocate the barriers and measure their dimensions and orientation. The spatial data from this survey provided the blueprint to represent the effect of the barriers in a 2D hydraulic model.

The observed variability in peak flow reductions illustrates that more research into monitoring overland flow and a subsequent model validation method is required to understand which representation is most accurate.

Leaky barrier representation Scenario S3 predicted total hillslope runoff peak flow to reduce by 16.6% in a 1:1-year design return period. However, this reduction diminished as rainfall intensity increased. Time to peak only lagged by 10 min compared to the baseline. During return periods of over 1:30 years, peak flow was predicted to reduce by less than 5%. Further analysis also predicted only 14.3%–21.7% of the total additional storage provided by the leaky barriers is mobilised during simulated events.

A measurable effect on peak flow and event volume retention was also observed in the December 2015 simulation. However, this event identified that the hillslope leaky barriers become less effective during close rainfall events with multiple peaks, due to the model becoming saturated. The storage created by the barriers becomes filled by the inflow of the initial rainfall, preventing the storage being mobilised by following storm peaks.

ACKNOWLEDGEMENTS

This study was undertaken as the lead author's dissertation while studying an MSc (Eng) in Environmental Engineering and Project Management at the University of Leeds. The authors gratefully acknowledge the commitment and support of RPS Group during this project. Thank you to Amy Jones for her feedback and recommendations on the completion of the paper. The authors also thank Craig Best and Rosie Holdsworth of the National Trust, as well as Sally Kelling of the Environment Agency for their inputs and discussions and access to the Hardcastle Crags site. The authors extend this thanks to the members of Slow the Flow Calderdale for their voluntary involvement in building the interventions on this site. Lastly, the authors' sincere thanks go to Stephen Hammond and Andrew Senior for their assistance collecting data in the field. This study was supported as part of the Yorkshire Integrated Catchment Solutions Programme (iCASP, NERC Grant: NE/P011160/1).

DATA AVAILABILITY STATEMENT

Data are openly available from the corresponding author.

ORCID

Jake G. Senior  <https://orcid.org/0000-0002-8886-3884>

Mark A. Trigg  <https://orcid.org/0000-0002-8412-9332>

Thomas Willis  <https://orcid.org/0000-0003-0103-1805>

REFERENCES

- Abbe, T. (2006). *Conceptual design guidelines: Application of engineered logjams*. Scottish Environment Protection Agency. https://www.sepa.org.uk/media/152246/wat_sg_37.pdf
- Abbe, T., & Montgomery, D. (1996). Large woody debris jams, channel hydraulics and habitat formation in large rivers. *Regulated Rivers: Research and Management*, 12, 201–221. <https://>

- [doi.org/10.1002/\(SICI\)1099-1646\(199603\)12:2/3<201::AID-RRR390>3.0.CO;2-A](https://doi.org/10.1002/(SICI)1099-1646(199603)12:2/3<201::AID-RRR390>3.0.CO;2-A)
- Addy, S., & Wilkinson, M. (2019). Representing natural and artificial in-channel large wood in numerical hydraulic and hydrological models. *Wiley Interdisciplinary Reviews: Water*, 6, 1389. <https://doi.org/10.1002/wat2.1389>
- Black, A., Peskett, L., MacDonald, A., Young, A., Spray, C., Ball, T., Thomas, H., & Werrity, A. (2021). Natural flood management, lag time and catchment scale: Results from an empirical nested catchment study. *Journal of Flood Risk Management*, 14, e12717. <https://doi.org/10.1111/jfr3.12717>
- Cabaneros, S., Danieli, F., Formetta, G., Gonzalez, R., Grinfeld, M., Hankin, B., Hewitt, I., Johnstone, T., Kamilova, A., Kovacs, A., Kretzschmar, A., Kiradjiev, K., Pegler, S., Sander, G., Wong, C. (2018). JBA trust challenge: A risk-based analysis of small scale, distributed, “nature-based” flood risk management measures deployed on river networks. <http://www.turinggateway.cam.ac.uk/event/tgmw41/programme>
- Calderdale Council. (2017). Section 19 report: Flood events of November and December 2015. Calderdale Metropolitan Borough Council. https://www.calderdale.gov.uk/nweb/COUNCIL.minutes_pkg.view_doc?p_Type=AR&p_ID=50542
- Cashman, M., Wharton, G., Harvey, G., Naura, M., & Bryden, A. (2019). Trends in the use of large wood in UK river restoration projects: Insights from the National River Restoration Inventory. *Water and Environment Journal*, 33, 318–328. <https://doi.org/10.1111/wej.12407>
- Centre for Ecology and Hydrology. (1999). *Flood estimation handbook*. Centre for Ecology and Hydrology (formerly the Institute of Hydrology).
- Chappell, N. (2020). NERC evaluating NFM Programme: Measuring NFM effectiveness. NERC webinar series. https://research.reading.ac.uk/nerc-nfm/webinar_recordings/
- Dadson, S., Hall, J., Murgatroyd, A., Acreman, M., Bates, P., Beven, K., Heathwaite, L., Holden, J., Heathwaite, I. P. H. L., Holden, J., Holman, I. P., Lane, S. N., O’Connell, E., Penning-Rowsell, E., Reynard, N., Sear, D., Thorne, C., & Wilby, R. (2017). A restatement of the natural science evidence concerning catchment-based “natural” flood management in the UK. *Proceedings of the Royal Society A: Mathematical, Physical and Engineering Sciences*, 473, 1–19. <https://doi.org/10.1098/rspa.2016.0706>
- Diaz, R. (2005). Analysis of manning coefficient for small-depth flows on vegetated beds. *Hydrological Processes*, 19, 3221–3233. <https://doi.org/10.1002/hyp.5820>
- Dixon, S., Sear, D., Odoni, N., Sykes, T., & Lane, S. (2016). The effects of river restoration on catchment scale flood risk and flood hydrology. *Earth Surface Processes and Landforms*, 41, 997–1008. <https://doi.org/10.1002/esp.3919>
- Eye on Calderdale. (2021, January 25). *History of flooding in Calderdale*. <https://eyeoncalderdale.com/history-of-flooding-in-calderdale>
- Ferguson, C., & Fenner, R. (2020). The impact of Natural Flood Management on the performance of surface drainage systems: A case study in the Calder Valley. *Journal of Hydrology*, 590, 125354. <https://doi.org/10.1016/j.jhydrol.2020.125354>
- Garner, G., Hannah, D., & Watts, G. (2017). Climate change and water in the UK: Recent scientific evidence for past and future change. *Progress in Physical Geography*, 41, 154–170. <https://doi.org/10.1177/0309133316679082>
- Hessel, R., Jetten, V., & Guanghai, Z. (2003). Estimating Manning’s n for steep slopes. *Catena*, 54, 77–91. [https://doi.org/10.1016/S0341-8162\(03\)00058-4](https://doi.org/10.1016/S0341-8162(03)00058-4)
- Howgate, O., & Kenyon, W. (2008). Community cooperation with natural flood management: A case study in the Scottish borders. *Royal Geographical Society*, 41, 329–340. <https://doi.org/10.1111/j.1475-4762.2008.00869.x>
- Kjeldsen, T., Stewart, E., Packman, J., Folwell, S., & Bayliss, A. (2005). Revitalisation of the FSR/FEH rainfall-runoff method. Defra R&D Technical Report FD1913. https://assets.publishing.service.gov.uk/media/602ba595d3bf7f031745a021/Revitalisation_of_the_FSRFEH_rainfall_runoff_method_summary.pdf
- Liu, Y., Gebremeskel, S., De Smedt, F., Hoffmann, L., & Pfister, L. (2004). Simulation of flood reduction by natural river rehabilitation using a distributed hydrological model. *Hydrology and Earth System Sciences Discussions*, 8, 1129–1140. <https://doi.org/10.5194/hess-8-1129-2004>
- Metcalfe, P., Beven, K., Hankin, B., & Lamb, R. (2018). A new method, with application, for analysis of the impacts on flood risk of widely distributed enhanced hillslope storage. *Hydrology and Earth System Sciences*, 22, 2589–2605. <https://doi.org/10.5194/hess-22-2589-2018>
- Ndomba, P. (2014). Streamflow data needs for water resources management and monitoring challenges: A case study of Wami River subbasin in Tanzania. In A. Melesse, W. Abtew, & S. Setegn (Eds.), *Nile River basin*. Springer. https://doi.org/10.1007/978-3-319-02720-3_3
- Pinto, C., Ing, R., Browning, B., Delboni, V., Wilson, H., Martyn, D., & Harvey, G. (2019). Hydromorphological, hydraulic and ecological effects of restored wood: Findings and reflections from an academic partnership approach. *Water and Environment Journal*, 33, 353–365. <https://doi.org/10.1111/wej.12457>
- Ramsbottom, D., Pinto, A., Roca, M., & Body, R. (2019). *Effectiveness of natural flood management measures*. IAHR World Congress. <https://static.iahr.org/34/368.pdf>
- Rasche, D., Reinhardt-Imjela, C., Schulte, A., & Wenzel, R. (2019). Hydrodynamic simulation of the effects of in-channel large woody debris on the flood hydrographs of a low mountain range creek, Ore Mountains, Germany. *Hydrology and Earth System Sciences Discussions*, 23, 4349–4365. <https://doi.org/10.5194/hess-2019-35>
- Salazar, S., Frances, F., Komma, J., Blume, T., Francke, T., Bronstert, A., & Blöschl, G. (2012). A comparative analysis of the effectiveness of flood management measures based on the concept of “retaining water in the landscape” in different European hydro-climatic regions. *Natural Hazards and Earth System Sciences*, 12, 3287–3306. <https://doi.org/10.5194/nhess-12-3287-2012>
- Samra, A. (2017). The effects of natural flood management in rural catchments: A research and hydraulic modelling study. https://www.researchgate.net/profile/Alberto-Pinto-Samra/publication/320455848_The_Effects_of_Natural_Flood_Management_in_Rural_Catchments_A_research_and_hydraulic_modelling_study_applied_within_the_River_Thames_catchment_in_the_United_Kingdom/links/59e63efaaca2721fc227a2bf/The-Effects-of-Natural-Flood-Management-in-Rural-Catchments-A-research-and-hydraulic-modelling-study-applied-within-the-River-Thames-catchment-in-the-United-Kingdom.pdf

- Slow the Flow. (2021, January 25). Hardcastle crags. <https://slowtheflow.net/hardcastle-crags/>
- Sörensen, J., Persson, A., Sternudd, C., Aspegren, H., Nilsson, J., Nordström, J., Jönsson, K., Mottaghi, M., Becker, P., Pilesjö, P., Larsson, R., Berndtsson, R., & Mobini, S. (2016). Re-thinking urban flood management-time for a regime shift. *Water*, 8, 332. <https://doi.org/10.3390/w8080332>
- Thompson, V., Dunstone, N., Scaife, A., Smith, D., Slingo, J., Brown, S., & Belcher, S. (2017). High risk of unprecedented UKrainfall in the current climate. *Nature Communications*, 8, 1–6. <https://doi.org/10.1038/s41467-017-00275-3>
- Wells, J., Labadz, J., Smith, A., & Islam, M. (2020). Barriers to the uptake and implementation of natural flood management: A social-ecological analysis. *Journal of Flood Risk Management*, 13, 1–12. <https://doi.org/10.1111/jfr3.12561>

SUPPORTING INFORMATION

Additional supporting information may be found in the online version of the article at the publisher's website.

How to cite this article: Senior, J. G., Trigg, M. A., & Willis, T. (2022). Physical representation of hillslope leaky barriers in 2D hydraulic models: A case study from the Calder Valley. *Journal of Flood Risk Management*, 15(3), e12821. <https://doi.org/10.1111/jfr3.12821>