

This is a repository copy of *Modelling of transmission and reflection of thin layers for EMC applications in TLM*.

White Rose Research Online URL for this paper:

<https://eprints.whiterose.ac.uk/184145/>

Version: Accepted Version

---

**Book Section:**

Dawson, J F orcid.org/0000-0003-4537-9977, Cole, J A and Porter, S J (1997) Modelling of transmission and reflection of thin layers for EMC applications in TLM. In: *Electromagnetic Compatibility, 1997. 10th International Conference on. IEEE , COVENTRY , pp. 65-70.*

<https://doi.org/10.1049/cp:19971120>

---

**Reuse**

Items deposited in White Rose Research Online are protected by copyright, with all rights reserved unless indicated otherwise. They may be downloaded and/or printed for private study, or other acts as permitted by national copyright laws. The publisher or other rights holders may allow further reproduction and re-use of the full text version. This is indicated by the licence information on the White Rose Research Online record for the item.

**Takedown**

If you consider content in White Rose Research Online to be in breach of UK law, please notify us by emailing [eprints@whiterose.ac.uk](mailto:eprints@whiterose.ac.uk) including the URL of the record and the reason for the withdrawal request.

# Modelling of transmission and reflection of thin layers for EMC applications in TLM

J. F. Dawson, J. A. Cole, S. J. Porter  
Department of Electronics, University of York, England

## Abstract

The paper describes a method for designing recursive filters for frequency dependent boundary conditions in the TLM method using frequency domain data. The approach described here allows the development of boundary conditions representing thin inhomogeneous composite materials where an analytical approach is excessively complex. It has applications in EMC for the modelling of ferrite tile absorber materials, composite equipment enclosures, and mesh screens such as those used to shield apertures.

## Introduction

The Transmission Line Matrix (TLM) method has been used to model enclosures whose walls are composed of material which is strongly conducting. Typically energy penetration into such enclosures is via apertures and cabling: the walls can be considered to be approximated by perfect conductors. As such the walls are often incorporated using a boundary between nodes in the TLM mesh. The effects of the walls are modelled using frequency-independent reflection coefficients, typically of value  $-1$ : there is no transmission allowed. This has proved to be successful where the dominant energy penetration mechanism is via apertures.

In the case where the enclosure walls are composed of a material which is not opaque to electromagnetic energy (for example, materials with conductivities in the range of  $1 \text{ kS/m}$  to  $30 \text{ kS/m}$ ), and where the energy penetration mechanism is not dominantly through apertures and cabling, the use of a fixed reflection coefficient and zero transmission coefficient is inadequate. In this case, it is necessary to use boundaries with frequency dependent reflection and transmission coefficients.

Direct incorporation of the walls within the normal TLM mesh is possible, but requires a prohibitively small grid size.

The TLM method has also been used to model ferrite tile absorbers [1] but the fine grid (Typically  $1 \text{ mm}$ ) necessary for modelling the tile directly prevents its application to larger problems.

## Thin Layer Models

Various methods for circumventing this problem have been tried. Mallik and Loller [2] present a method using a par-

allel combination of resistors to represent the frequency dependent reflection and transmission properties of thin sheets of conducting materials. This becomes computationally inefficient when many layers of resistance are required to model the composite structure.

Since the lateral propagation in such materials is negligible, the efficiency of the computation can be increased if only propagation through the layer is considered. Johns et al [3] have proposed such a method using lossy, loaded transmission lines later improved by Trenkic [4].

Fuchs [5] has succeeded in demonstrating a full analytical, time-domain solution to the transmission through thin, homogeneous, isotropic conducting layers. The authors have also presented an approximate solution [6] in series form using a filter design of the type proposed in this paper.

Other thin layer models have been derived for the Finite Difference Time-Domain method. A vast majority of this work is concerned with perfect conductors [7], or infinitely thin sheets [8]. Other methods such as those described by Maloney [9] primarily consider the modelling of thin conducting sheets of relatively low conductivity. They do not take into account the decay of fields propagating through a conductor which is many skin-depths thick.

A similar thin layer model has been used by the Author to model effect of ferrite tile absorbers in enclosures, and screened rooms [10]. It relies on an empirical formula for the reflection coefficient of the ferrite tiles using the manufacturers measured reflection data. It is not able to accurately model all types of tile.

The new method proposed here allows an accurate approximation of frequency dependent transmission and reflection coefficients for thin layers from measured or computed data.

## New thin layer model

The implementation described here is designed in the frequency domain using discrete time recursive digital filters. It is applicable to materials that cannot be solved by analytical means - such as ferrite tiles, composite materials with complex internal structures, meshes and grids. It is however limited to materials where one-dimensional propagation can be assumed - e.g. thin layers containing conductive or lossy material. The filter algorithm can be determined from measured, frequency-domain data or a detailed small scale model. This paper describes the design of the filter algorithms from measured or computed data and demonstrates the application for computed results.

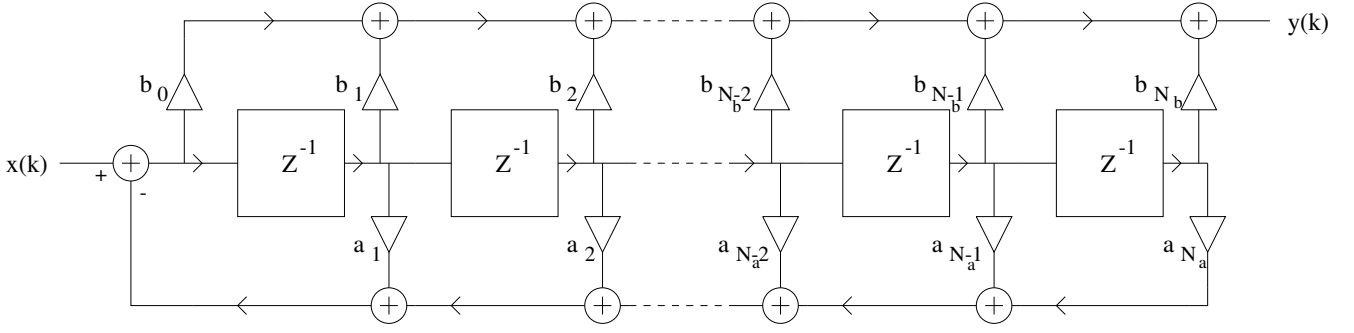

Figure 1: Structure of an  $N$ th order recursive digital filter

## Use of digital filters as frequency dependent boundaries in TLM

This section reviews the operation of recursive digital filters and their application as frequency dependent boundaries in TLM.

### Digital filters

Digital filters are the embodiment of a set of difference equations in a sampled data system. Figure 1 shows one way of implementing a digital filter of order  $N$ , where the order  $N$  is the greater of the orders  $N_b$  and  $N_a$ . The unit time delay is represented by the boxes marked  $Z^{-1}$ , the triangles labelled  $a_n$  or  $b_n$  are coefficient multipliers, and the circles containing a plus sign are adders (with a minus sign on an input denoting subtraction). The transfer function of the filter is often described as a ratio of polynomials in  $Z^{-1}$ . This can be used to determine the time response of the filter, by means of  $Z$ -transforms, or the frequency response of the filter by letting  $Z = \exp(j\omega T_s)$  where  $\omega$  is the angular frequency and  $T_s$  is the sampling period. For Figure 1 the transfer function in  $Z^{-1}$  is given in Equation 2.

$$H(Z) = \frac{b_0 + Z^{-1}b_1 + \dots + Z^{-(N_b-1)}b_{N_b-1} + Z^{-N_b}b_{N_b}}{1 + Z^{-1}a_1 + \dots + Z^{-(N_a-1)}a_{N_a-1} + Z^{-N_a}a_{N_a}} \quad (1)$$

Using the structure of Figure 1 can cause numerical problems. In practice filters are often implemented as a cascade of second order sections which gives improved numerical accuracy. In order for the filter to be stable the poles of Equation 2 (zeros of the denominator) must lie inside the unit circle on the  $Z$ -plane.

### Realisation of TLM boundary

The digital filter as described above has a single input and a single output. A boundary in TLM is defined by reflection and transmission in two directions and each with two polarisations. For each boundary element, four filters must be used for transmission and four for reflection. Often the number of filters can be reduced: e.g. to model ferrite tiles [11], used as radio absorptive material against a metal

backing, only the reflection coefficients for one direction and two polarisations are required.

## The Wiener-Hopf algorithm applied to recursive design

Here the design of a least-mean-squares ‘best-fit’ filter using measurement or simulation data is described. The method is based on a novel application of the Wiener-Hopf equation for signal estimators as described in [12, pp250-264]. The same method is also described by Levy [13] and used in the Matlab ‘Signal processing toolbox’ [14] routines ‘invfreqz’ and ‘invfreqs’.

If we rewrite Equation 2 as:

$$H(Z) = \frac{B(Z)}{1 + A(Z)} \quad (2)$$

and assume we wish to choose the coefficients of  $A(Z)$  and  $B(Z)$  so that  $H(Z)$  is the best fit to the function  $G(Z)$ . The error in the fit, in the frequency domain is given by:

$$\epsilon'(j\omega) = S(j\omega) \left\{ \frac{B(j\omega)}{1 + A(j\omega)} - G(j\omega) \right\} \quad (3)$$

where  $\epsilon'(j\omega)$  is the error,  $G(j\omega)$  is the desired frequency response and  $H(j\omega)$  is the frequency response of the filter calculated by substituting  $Z = \exp(j\omega T_s)$  in  $H(Z)$ .  $S(j\omega)$  is a weighting function which can be chosen to make the problem more sensitive to errors at particular frequencies.

In principle the mean squared error  $|\overline{\epsilon}|^2$  can be calculated and minimised over the desired frequency range. However  $H$  has very non-linear dependence on the coefficients of  $A$  and is difficult to minimise. Widrow and Stearns [12, pp250-264] suggest an alternative formulation which overcomes this problem. If we multiply both sides of Equation 3 by  $(1 + A(j\omega))$  we get:

$$\begin{aligned} \epsilon(j\omega) &= (1 + A(j\omega))\epsilon'(j\omega) \\ &= -S(j\omega)G(j\omega) - S(j\omega)G(j\omega)A(j\omega) + \\ &\quad S(j\omega)B(j\omega) \end{aligned} \quad (4)$$

The new error  $\epsilon$  is dependent upon  $A$  but minimising  $|\overline{\epsilon}|^2$  also minimises  $|\overline{\epsilon'}|^2$ .

If we make  $[\epsilon]$  a column vector of  $K$  samples of the error at discrete frequencies  $\omega_k$ , Equation 5 can be written as:

$$[\epsilon] = [D] - [X][W] \quad (5)$$

where  $[D]$  is the vector containing the product  $-s_k g_k$ :

$$[D] = [-s_1 g_1, -s_2 g_2, \dots, -s_K g_K]^T \quad (6)$$

$[X]$  is the matrix combining the products  $s_k g_k e^{-n_a j \omega_k T_s}$ ,  $n_a = 1, \dots, N_a$  and  $-s_k e^{-n_b j \omega_k T_s}$ ,  $n_b = 0, \dots, N_b$  which multiply the coefficients  $a_{n_a}$  and  $b_{n_b}$  of the filter:

$$[X] = \begin{bmatrix} s_1 g_1 e^{-j \omega_1 T_s} & s_1 g_1 e^{-2j \omega_1 T_s} & \dots & s_1 g_1 e^{-N_a j \omega_1 T_s} & -s_1 & -s_1 e^{-j \omega_1 T_s} \dots & -s_1 e^{-N_b j \omega_1 T_s} \\ s_2 g_2 e^{-j \omega_2 T_s} & s_2 g_2 e^{-2j \omega_2 T_s} & \dots & s_2 g_2 e^{-N_a j \omega_2 T_s} & -s_2 & -s_2 e^{-j \omega_2 T_s} \dots & -s_2 e^{-N_b j \omega_2 T_s} \\ s_3 g_3 e^{-j \omega_3 T_s} & s_3 g_3 e^{-2j \omega_3 T_s} & \dots & s_3 g_3 e^{-N_a j \omega_3 T_s} & -s_3 & -s_3 e^{-j \omega_3 T_s} \dots & -s_3 e^{-N_b j \omega_3 T_s} \\ \vdots & \vdots & \ddots & \vdots & \vdots & \vdots & \vdots \\ s_K g_K e^{-j \omega_K T_s} & s_K g_K e^{-2j \omega_K T_s} & \dots & s_K g_K e^{-N_a j \omega_K T_s} & -s_K & -s_K e^{-j \omega_K T_s} \dots & -s_K e^{-N_b j \omega_K T_s} \end{bmatrix} \quad (7)$$

$[W]$  is the vector containing the (unknown) filter coefficients  $a_{n_a}$  and  $b_{n_b}$ :

$$[W] = [a_1, a_2, \dots, a_{N_a}, b_0, b_1, \dots, b_{N_b}]^T \quad (8)$$

If  $\Re(x)$  denotes the real part of  $x$ ,  $[Q]^T$  is the transpose of  $[Q]$  and  $[Q]^*$  is the conjugate transpose of  $[Q]$ , the mean squared error is:

$$\begin{aligned} \overline{|\epsilon|^2} &= \frac{1}{K} \Re \{ [\epsilon]^* [\epsilon] \} \\ &= \frac{1}{K} \Re \{ [D]^* [D] + [W]^T [X]^* [X] [W] - 2[D]^* [X]^* [W] \} \end{aligned}$$

If we let  $[R] = \Re \{ [X]^* [X] \}$  and  $P = \Re \{ [X]^* [D] \}$  then

$$\overline{|\epsilon|^2} = \frac{1}{K} \{ [D]^* [D] + [W]^T [R] [W] - 2[P]^T [W] \} \quad (9)$$

In order to determine the minimum mean squared error we can differentiate Equation 9 with respect to the coefficient vector,  $[W]$ , and equate to zero:

$$\frac{\partial \overline{|\epsilon|^2}}{\partial [W]} = \frac{1}{K} \{ 2[R][W] - 2[P] \} = 0 \quad (10)$$

This is a system of linear equations which can be solved by matrix inversion to give the filter coefficients:

$$[W] = [R]^{-1} [P] \quad (11)$$

Thus it is possible to design a filter to give a least-mean-squares fit to measured or computed data for a thin layer.

This technique has two potential problems:

1. The filter design is not necessarily stable.
2. The required filter order is also unknown.

The next section shows results of using the method to design filters to match reflection and transmission coefficients.

## Results

### Perforated screen

Here the transmission coefficient of a perforated screen was simulated using a fine grid TLM model (0.1 mm) and the resulting frequency domain data used to design a transmission filter for use as a boundary in a larger mesh (10 cm). A set of 50 data points were used to represent the frequency domain data (ie.  $K = 50$ ). Filters of increasing order were designed and the mean squared error for a range is tabulated in Table 1 below. The weighting function  $S = 1/|G|$  was used so that the relative error tended to be the same at all frequency points. Filters of order 10 and above were unstable and therefore not used.

Figures 2 and 3 show the magnitude and phase response of the filters of order 2 and 9 with the original specified response. Figures 4 and 5 show the error in magnitude and phase response of the filters as a function of frequency. The frequency range extends to half the sampling frequency of the 10 cm mesh, however results from TLM would normally only be used for one tenth of this range. It can be seen that both filters have better accuracy in the low frequency range, this is probably due to the difficulty of controlling the frequency response near the upper limit in digital filters.

Poles	Zeros	Mean squared error	Note
2	2	0.00049888	
8	4	0.00024546	
9	9	0.00016312	
10	10	0.00011883	Unstable

Table 1: Mean squared error for a range of ‘perforated screen’ filter designs

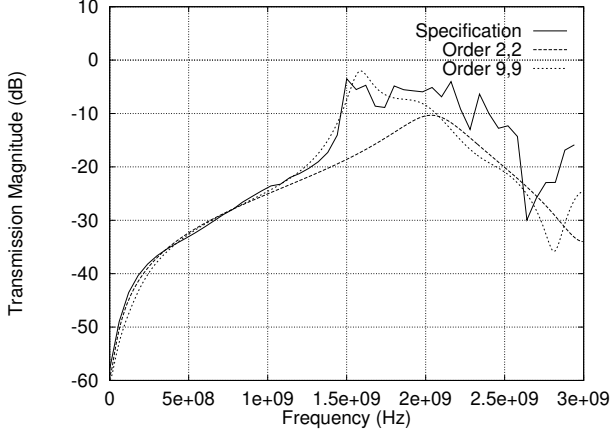

Figure 2: Frequency response of transmission through a perforated screen (Specification) and filter designs of order 2 and 9.

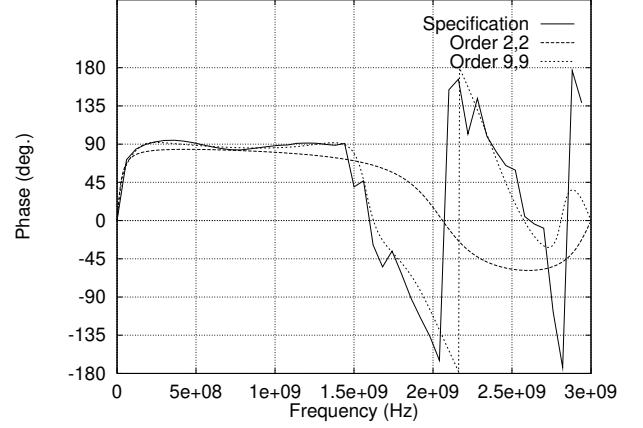

Figure 3: Phase response of transmission through a perforated screen (Specification) and filter designs of order 2 and 9.

## Ferrite tile

The reflection coefficient of a ferrite tile was computed with TLM using a 1.05 mm grid using the technique in [1]. The Wiener-Hopf design technique was then used to compute the filter design suitable for use in a TLM model with 10 cm grid. This was also compared with the 2nd order approximation described in [10]. A set of 200 data points were used to represent the frequency domain data (ie.  $K = 200$ ). Filters of order 3 or less produced unsatisfactory results. The first design to produce an acceptable approximation to the desired frequency response was of order 4. It was however unstable. The filter was sta-

bilised by removing the unstable pole and nearby zero, or alternatively by simply moving the unstable pole inside the unit circle such that its effect on the magnitude response was unchanged. The mean squared error for a number of designs is shown below in Table 2 below. Filters 1–3 have  $S = 1/|G|$  however it was noticed that the zero frequency gain of the filter had a large error. For filters 4 and 5 the zero frequency weighting was increased by a factor of 10 which reduced the zero frequency error for a small increase in overall error (comparing filter 5 with filter 2). This demonstrated the importance of the weighting function in controlling the overall error.

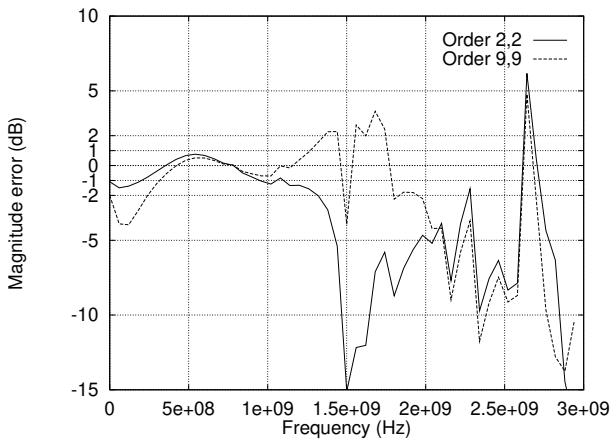

Figure 4: Magnitude error for ‘perforated screen’ filter designs of order 2 and 9.

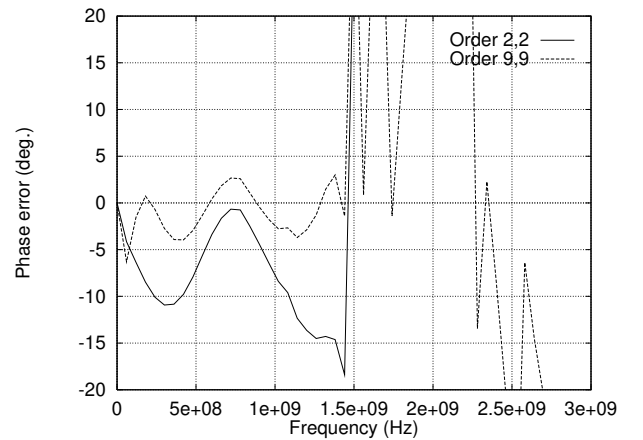

Figure 5: Phase error for ‘perforated screen’ filter designs of order 2 and 9.

No.	Poles	Zeros	Mean squared error	Note
1	4	4	0.00024291	Unstable $S = 1/G$
2	3	3	0.0023514	By removing pole and zero outside unit circle from 1 By stabilising polynomial of 1
3	3	3	0.013959	
4	4	4	0.00030563	Unstable (changed $S$ )
5	3	3	0.0024013	By removing pole and zero outside unit circle from 4

Table 2: Mean squared error for a range of ‘ferrite tile’ filter designs

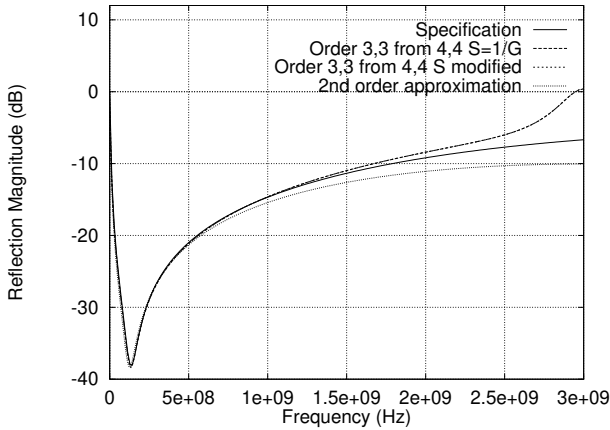

Figure 6: Frequency response of reflection from a ferrite tile absorber (Specification) and filter designs of order 2 and 3.

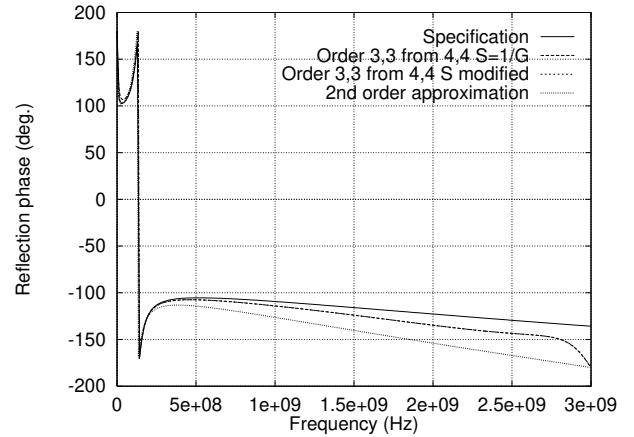

Figure 7: Phase response of reflection from a ferrite tile absorber (Specification) and filter designs of order 2 and 3.

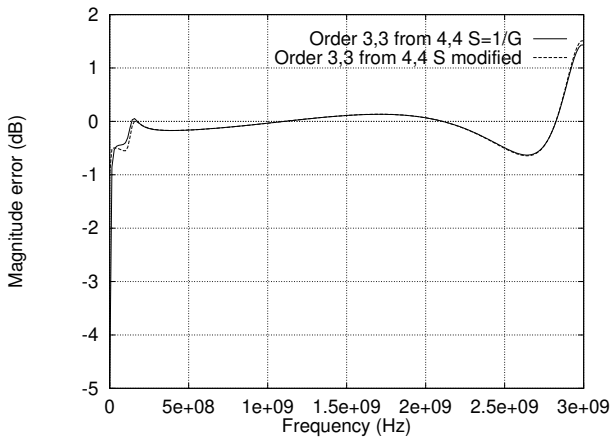

Figure 8: Magnitude error for the ‘ferrite tile’ filter designs of order 3.

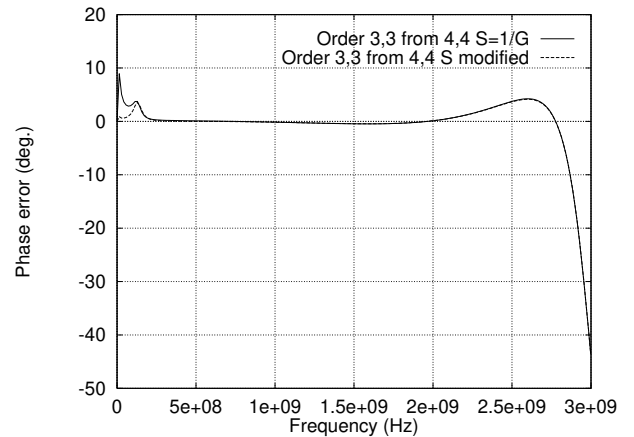

Figure 9: Phase error for the ‘ferrite tile’ filter designs of order 3.

Figures 6 and 7 show the frequency and phase response of the two 3rd order filters compared with the specified frequency response and the result of the 2nd order approximation of [10]. The responses of the two 3rd order filters are almost indistinguishable at this resolution. It can be seen that the Wiener-Hopf design is slightly more accurate than the 2nd order approximation at higher frequencies. However phase information is required for the Wiener-Hopf design which must be measured or determined by simulation

whilst the 2nd order approximation can be computed from the magnitude of the tile’s reflection coefficient only. Figures 8 and 9 show the error in the magnitude and phase response of the 3rd-order filters as a function of frequency.

## Conclusions

The Wiener-Hopf algorithm allows frequency dependent boundary conditions to be designed from measured or com-

puted frequency response (phase and magnitude). However the order of the filter must be determined experimentally and sometimes manual interaction is required to stabilise the filter.

The algorithm will find application in the modelling of thin lossy layers, such as composite materials, where the transmission and reflection coefficients can be measured or computed in the frequency domain.

The filter based boundary conditions have been installed in the "Hawk" TLM package at York and demonstrated for ferrite tiles [11, 10] and thin conducting layers [6] using analytical formulations approximating the frequency response of reflection and transmission. The new technique described here allows boundaries to be formulated for layers using measured or computed data where a suitable analytical formulation is not available.

## Acknowledgments

The authors would like to thank British Aerospace, Lucas Varity, EPSRC, D.G. Teer Coatings who have supported this work.

## References

- [1] J.F. Dawson. Improved magnetic loss for TLM. *Electronics Letters*, 29(5):467–468, 1993.
- [2] A. Mallik and C. P. Loller. The modelling of EM leakage into advanced composite enclosures using the TLM technique. *International Journal of Numerical Modelling, Electronic Networks, Devices and Fields*, 2(4):241–248, 1989.
- [3] D.P. Johns, J. Wlodarczyk, and A. Mallik. New TLM models for thin structures. In *IEE Proc. International Conference on Computation in Electromagnetics*, pages 335–338, 1991.
- [4] V. Trenkic, A. P. Duffy, T. M. Benson, and C. Christopoulos. Numerical simulation of penetration and coupling using the TLM method. In *EMC'94 Roma*, pages 321–326, 13–16 September 1994.
- [5] Ch. Fuchs and A. J. Schwab. Efficient computation of 3D shielding enclosures in time domain with TLM. In *COST 243 Workshop, Numerical Methods and their Applications, Hamburg*, June 1995.
- [6] J. A. Cole, J. F. Dawson, and S. J. Porter. Efficient modelling of thin conducting sheets within the TLM method. In *IEE 3rd Int. Conference on Computation in Electromagnetics*, Bath, 10–12 April 1996.
- [7] K.S. Kunz, D.J. Steich, and R.J. Luebbers. Low frequency shielding effects of a conducting shell with an aperture: Response of an internal wire. *IEEE Transactions on Antennas and Propagation*, pages 370–373, 1992.
- [8] L.-K. Wu and L.-T. Han. Implementation and application of resistive sheet boundary condition in the finite-difference time-domain method. *IEEE Transactions on Antennas and Propagation*, pages 628–632, 1992.
- [9] J.G. Maloney and G.S. Smith. A comparison of methods for modelling electrically thin dielectric and conducting sheets in the finite-difference time-domain (FDTD) method. *IEEE Transactions on Antennas and Propagation*, pages 690–694, 1993.
- [10] J.F. Dawson, J. Ahmadi, and A. C. Marvin. Modelling the damping of screened room resonances by ferrite tiles using frequency dependent boundaries in TLM. In *IEE 2nd Int. Conf. on Computation in Electromagnetics*, pages 271–274, 1994.
- [11] J.F. Dawson. Representing ferrite absorbing tiles as frequency dependent boundaries in TLM. *Electronics Letters*, 29(9):791–792, 1993.
- [12] B Widrow and S. D. Stearns. *Adaptive signal processing*. Prentice-Hall, 1985. ISBN 0-13-004029-01.
- [13] E. C. Levy. Complex curve fitting. *IRE Trans. on Automatic Control*, AC-4:37–44, 1959.
- [14] T. P. Krauss, L. Shure, and J. N. Little. *Signal processing toolbox for use with Matlab*. The Mathworks Inc., 1994.

Dawson, J. F.; Cole, J. A. & Porter, S. J. , "Modelling of transmission and reflection of thin layers for EMC applications in TLM" , IEE 10th Int. Conf on Electromagnetic Compatibility , 65-70 , September 1997. IEE conf pub 445