



UNIVERSITY OF LEEDS

This is a repository copy of *Three-state Markov chain based reliability analysis of complex traction power supply systems*.

White Rose Research Online URL for this paper:

<https://eprints.whiterose.ac.uk/181435/>

Version: Accepted Version

Proceedings Paper:

Zuo, W and Li, K orcid.org/0000-0001-6657-0522 (2022) Three-state Markov chain based reliability analysis of complex traction power supply systems. In: 2021 5th International Conference on System Reliability and Safety (ICSRS). 2021 5th International Conference on System Reliability and Safety, 24-26 Nov 2021, Palermo, Italy. IEEE , pp. 74-79. ISBN 978-1-6654-0049-7

<https://doi.org/10.1109/ICSRS53853.2021.9660623>

This item is protected by copyright. Personal use of this material is permitted. Permission from IEEE must be obtained for all other uses, in any current or future media, including reprinting/republishing this material for advertising or promotional purposes, creating new collective works, for resale or redistribution to servers or lists, or reuse of any copyrighted component of this work in other works. Uploaded in accordance with the publisher's self-archiving policy.

Reuse

Items deposited in White Rose Research Online are protected by copyright, with all rights reserved unless indicated otherwise. They may be downloaded and/or printed for private study, or other acts as permitted by national copyright laws. The publisher or other rights holders may allow further reproduction and re-use of the full text version. This is indicated by the licence information on the White Rose Research Online record for the item.

Takedown

If you consider content in White Rose Research Online to be in breach of UK law, please notify us by emailing eprints@whiterose.ac.uk including the URL of the record and the reason for the withdrawal request.



eprints@whiterose.ac.uk
<https://eprints.whiterose.ac.uk/>

Three-state Markov chain based reliability analysis of complex traction power supply systems

Wei Zuo
University of Leeds
School of Electronic and Electrical Engineering
Leeds, United Kingdom
elwz@leeds.ac.uk

Kang Li
University of Leeds
School of Electronic and Electrical Engineering
Leeds, United Kingdom
k.li1@leeds.ac.uk

Abstract—The reliability of traction power supply systems (TPSSs) is an important consideration in railway electrification and development of high-speed rail. The state analysis of the whole system and individual components often involves the construction of an appropriate system model. The Markov chain has been widely used to evaluate random processes quantitatively and is suitable for the reliability analysis of complex systems with multiple failure modes. A challenge with the Markov chain approach is the curse of dimensionality and its computational complexity increases exponentially with the number of system components. This paper proposes to use a three-state model and system regionalization based on the specific structural features of the TPSS. The failure probability of TPSS over time is analyzed and a new simplified method to compute the average system availability index is developed to evaluate system reliability. Simulation studies confirm that the proposed approach can derive a rich set of reliability indexes, and the reliability of TPSSs can be effectively evaluated.

Keywords—Markov chain, reliability analysis, TPSS availability index, average availability.

I. INTRODUCTION

With the rapid development of transportation electrification around the world to tackle the climate change challenge, how to ensure safe and reliable operation of traction power supply systems has become an increasingly important research topic [1]. For the electrified railway, a widely used public transportation means, to guarantee the operation reliability of its traction power supply system (TPSS) is at the heart of the railway system management and maintenance routines. The TPSS failures could delay the train or paralyze the entire line, causing significant economic losses and passenger dissatisfaction [2]. However, the railway TPSS has a complex structure with numerous subsystems. To ensure its safe operation, reliability analysis is vital for the follow-on planning of system maintenance and safe and reliable train operation.

The reliability analysis methods based on the Markov chain can be grouped to two modes in the time domain: namely discrete and continuous, and reliability analysis can be conducted through the system state transition diagram in these two modes [3-5]. In addition, Markov chain can be combined with Monte Carlo simulation for system reliability analysis in different traffic scenarios [6,7]. Markov chain modelling can not only be used for complex railway systems, including traction power supply systems and catenary systems, but also in aerospace, and other fields, thus possessing huge development potentials.

In practical applications, the increasing number of system components may lead to overly complex Markov chain

configuration and consequent huge calculation burdens. The simple two state Markov chain structure may no longer meet the requirements of system reliability analysis, while the multi-state Markov chain has overly complex matrix equations incurring huge number of calculations. The complexity of the Markov chain model increases exponentially with the number of components as well as the number of states. Therefore, how to effectively use the random model features of the Markov chains for complex system reliability analysis with simplified computational framework is a hot research topic. To address the aforementioned challenges, this paper proposes a reliability analysis method for complex systems based on a three state Markov chain. Through the derivation of system availability index and the regionalization of complex systems, the problem-solving procedure can be efficiently performed, and fairly satisfactory system reliability analysis results can also be obtained.

The remainder of this paper is organized as follows. Section II introduces the configuration of a simple two state Markov chain followed by the proposed three state Markov chain, and the procedures for calculating the system reliability index are also presented. In section III, the implementation of the proposed method for the reliability analysis of complex systems are described in detail. Section IV presents a case study by using the proposed method to analyze the reliability of a railway TPSS and section V concludes the paper.

II. THE PROPOSED METHOD

The Markov process is used to model a stochastic process with random state variables $X(t_n)$ at time t_n . The state variables $X(t_n)$ at time t_n are only related to the previous states $X(t_i)$ ($i < n$) of a finite number of time steps and are independent on states $X(t_{n-1}), X(t_{n-2}), \dots, X(t_{n-i})$ ($i < n$). Hence, as a "no memory process", previous state of the Markov process does not affect the current one. The Markov process has been widely used to model stochastic processes, and it can quantitatively analyze the numerical, non-numerical, continuous and discrete states of complex systems, based on which the system reliability can be analyzed. The essence here for reliability study is that the Markov process can be used to derive the probability value of each working state, the failure state, and the time required for the system to reach a steady state.

To apply the Markov processes for system reliability analysis, the following assumptions are often required.

- The system should be repairable.

- The life span and maintenance time of the system units obey an exponential distribution.
- Unit states are independent of each other and have no influence between them.

The common steps for system reliability analysis are as follows:

- Build the system state transition diagram: define the system states and draw the system transition diagram based on the failure and repair process.
- Formulate the system state transition equation: define the Markov chain and formulate its state transition equations.
- Compute the system reliability index: based on the state transition equation and system initial states, use Laplace and its inverse transformation to solve the state transition equations to obtain the reliability indices.

A. Two State Markov Chain Process

Taking the simple two state repairable system as an example, the operating states of the system are normal working state and faulty working state. As shown in Fig.1, state '0' is usually used to indicate that the system is working normally, and the state '1' is used to indicate the system is under faulty working state. The state of the system at time t can then be represented by $X(t)$.

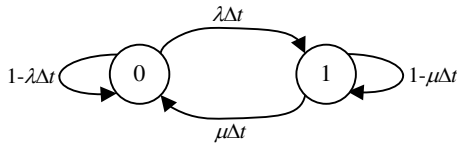

Fig. 1. A two-state system transition diagram

In Fig. 1, λ is the failure rate of the system, and μ is the repair rate of the system, Δt represents a very short time interval.

Taking a two state system in Fig.1 as an example, for this repairable system, the system state function is given as follows.

$$X(t) = \begin{cases} 0, & \text{normal work state} \\ 1, & \text{faulty work state} \end{cases}$$

Suppose P_0 is the probability of the system in normal working state, and P_1 is the system in abnormal working state. According to the state transition diagram, the state transition function at the time instant $[t, t+\Delta t]$ is given as follows.

$$\begin{bmatrix} P_0(t+\Delta t) \\ P_1(t+\Delta t) \end{bmatrix} = \begin{bmatrix} 1-\lambda\Delta t & \mu\Delta t \\ \lambda\Delta t & 1-\mu\Delta t \end{bmatrix} \cdot \begin{bmatrix} P_0(t) \\ P_1(t) \end{bmatrix} \quad (1)$$

Where $\begin{bmatrix} 1-\lambda\Delta t & \mu\Delta t \\ \lambda\Delta t & 1-\mu\Delta t \end{bmatrix}$ is the transition matrix of the Markov Chain, denoted as $P(\Delta t)$, which represents the instantaneous transition probabilities from one state to another. The availability $A(t)$ of the system can be derived below.

$$A(t) = \frac{\mu}{\lambda + \mu} + \frac{\lambda}{\lambda + \mu} e^{-(\lambda + \mu)t} \quad (2)$$

When t tends to positive infinity, the steady-state availability of the system becomes below.

$$A(t) = \frac{\mu}{\lambda + \mu} \quad (3)$$

B. Three-State Markov Chain Process

As the number of system components increases, the complexity of the overall system states also increases, and the simple two-state repairable system model can no longer meet the requirements for reliability analysis. Therefore, a three-state Markov chain model which can represent different system areas is used to evaluate the reliability of a complex system, and a new time-based system average availability index is introduced to analyze and evaluate the overall system reliability.

The new three state Markov chain of system state transition diagram is built shown in the Fig.2. State '0' represents the normal working state, and states '1' and '2' respectively represent abnormal working state under different subsystem failure states.

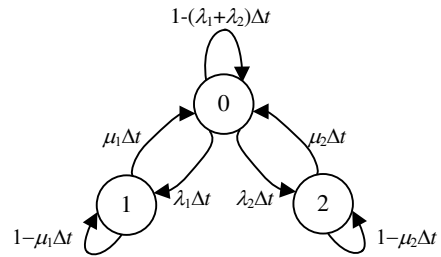

Fig. 2. Three state system transition diagram

Based on Fig.2, the system state transition equation in time $[t, t+\Delta t]$ can be derived. While P_0 is the system normal work state, and P_1 and P_2 are the probabilities of two different system abnormal work states. The instantaneous availability of the system is given below.

$$\begin{bmatrix} P_0(t+\Delta t) \\ P_1(t+\Delta t) \\ P_2(t+\Delta t) \end{bmatrix} = \begin{bmatrix} 1-(\lambda_1+\lambda_2)\Delta t & \mu_1\Delta t & \mu_2\Delta t \\ \lambda_1\Delta t & 1-\mu_1\Delta t & 0 \\ \lambda_2\Delta t & 0 & 1-\mu_2\Delta t \end{bmatrix} \begin{bmatrix} P_0(t) \\ P_1(t) \\ P_2(t) \end{bmatrix} \quad (4)$$

$$P_0(t) = \frac{\mu_1\mu_2}{\lambda_1\mu_2 + \lambda_2\mu_1 + \mu_1\mu_2} + \frac{-\lambda_1(\lambda_1 + \mu_1 - \mu_2)}{(\lambda_1 + \mu_1)[(\lambda_2 + \mu_2) - (\lambda_1 + \mu_1)]} e^{-(\lambda_1 + \mu_1)t} + \frac{-\lambda_2(\lambda_2 + \mu_2 - \mu_1)}{(\lambda_2 + \mu_2)[(\lambda_1 + \mu_1) - (\lambda_2 + \mu_2)]} e^{-(\lambda_2 + \mu_2)t}$$

$$P_1(t) = \frac{\lambda_1\mu_2}{\lambda_1\mu_2 + \lambda_2\mu_1 + \mu_1\mu_2} + \frac{\lambda_1(\lambda_1 + \mu_1 - \mu_2)}{(\lambda_1 + \mu_1)[(\lambda_2 + \mu_2) - (\lambda_1 + \mu_1)]} e^{-(\lambda_1 + \mu_1)t}$$

$$P_2(t) = \frac{\lambda_2\mu_1}{\lambda_1\mu_2 + \lambda_2\mu_1 + \mu_1\mu_2} + \frac{\lambda_2(\lambda_2 + \mu_2 - \mu_1)}{(\lambda_2 + \mu_2)[(\lambda_1 + \mu_1) - (\lambda_2 + \mu_2)]} e^{-(\lambda_2 + \mu_2)t} \quad (5)$$

As the time tends to positive infinity, the steady-state probability of all states can be expressed as follows.

$$\begin{aligned}
P_0(\infty) &= \frac{\mu_1\mu_2}{\lambda_1\mu_2 + \lambda_2\mu_1 + \mu_1\mu_2} \\
P_1(\infty) &= \frac{\lambda_1\mu_2}{\lambda_1\mu_2 + \lambda_2\mu_1 + \mu_1\mu_2} \\
P_2(\infty) &= \frac{\lambda_2\mu_1}{\lambda_1\mu_2 + \lambda_2\mu_1 + \mu_1\mu_2}
\end{aligned} \tag{6}$$

The above equations can be derived as follows.

According to the system state transition map, the state transition equations can be obtained.

$$\begin{cases}
P_0(t + \Delta t) = [1 - (\lambda_1 + \lambda_2)\Delta t]P_0(t) + \mu_1\Delta tP_1(t) + \mu_2\Delta tP_2(t) \\
P_1(t + \Delta t) = \lambda_1\Delta tP_0(t) + (1 - \mu_1\Delta t)P_1(t) \\
P_2(t + \Delta t) = \lambda_2\Delta tP_0(t) + (1 - \mu_2\Delta t)P_2(t)
\end{cases} \tag{7}$$

By taking the limit, the differential equation of the system can be derived as (8).

$$\begin{cases}
P_0'(t) = \lim_{\Delta t \rightarrow 0} \frac{P_0(t + \Delta t) - P_0(t)}{\Delta t} = -(\lambda_1 + \lambda_2)P_0(t) + \mu_1P_1(t) + \mu_2P_2(t) \\
P_1'(t) = \lim_{\Delta t \rightarrow 0} \frac{P_1(t + \Delta t) - P_1(t)}{\Delta t} = \lambda_1P_0(t) - \mu_1P_1(t) \\
P_2'(t) = \lim_{\Delta t \rightarrow 0} \frac{P_2(t + \Delta t) - P_2(t)}{\Delta t} = \lambda_2P_0(t) - \mu_2P_2(t)
\end{cases} \tag{8}$$

Taking the Laplace transform, the following can be derived.

$$\begin{cases}
sP_0(s) - P_0(0) = -(\lambda_1 + \lambda_2)P_0(s) + \mu_1P_1(s) + \mu_2P_2(s) \\
sP_1(s) - P_1(0) = \lambda_1P_0(s) - \mu_1P_1(s) \\
sP_2(s) - P_2(0) = \lambda_2P_0(s) - \mu_2P_2(s)
\end{cases} \tag{9}$$

Assuming $(SI-A)P(s)=P(0)$, Eq. (10) and (11) can be obtained.

$$\begin{bmatrix} s + \lambda_1 + \lambda_2, & -\mu_1, & -\mu_2 \\ -\lambda_1, & s + \mu_1, & 0 \\ -\lambda_2, & 0, & s + \mu_2 \end{bmatrix} \begin{bmatrix} P_0(s) \\ P_1(s) \\ P_2(s) \end{bmatrix} = \begin{bmatrix} P_0(0) \\ P_1(0) \\ P_2(0) \end{bmatrix} \tag{10}$$

where $P(s)=[P_0(s), P_1(s), P_2(s)]^T$, $P(0)=[1, 0, 0]^T$.

$$SI - A = \begin{bmatrix} s + \lambda_1 + \lambda_2, & -\mu_1, & -\mu_2 \\ -\lambda_1, & s + \mu_1, & 0 \\ -\lambda_2, & 0, & s + \mu_2 \end{bmatrix} \tag{11}$$

$$P(s) = (SI - A)^{-1}P(0) \tag{12}$$

The inversion of $(SI-A)$ is required to obtain $P(s)$, hence

$$(SI - A)^{-1} = \begin{bmatrix} \frac{a}{s} - \frac{b}{s + \lambda_1 + \mu_1} - \frac{c}{s + \lambda_2 + \mu_2} \\ \frac{(s + \mu_1)(s + \mu_2), & \mu_1(s + \mu_2), & \mu_2(s + \mu_1)}{\lambda_1(s + \mu_2), (s + \lambda_1 + \lambda_2)(s + \mu_2) - \lambda_2\mu_2, & \lambda_1\mu_2} \\ \lambda_2(s + \mu_1), & \mu_1\lambda_2, & (s + \lambda_1 + \lambda_2)(s + \mu_1) - \lambda_1\mu_1 \end{bmatrix} \tag{13}$$

Based on the assumption that failure rates of components are independent of each other, hence $\lambda_1\lambda_2=0$. Applying the partial fraction method and adverse Laplace method to solve (13), yielding

$$P(s) = \frac{a}{s} \begin{bmatrix} \mu_1\mu_2 \\ \lambda_1\mu_2 \\ \lambda_2\mu_1 \end{bmatrix} + \frac{b}{s + \lambda_1 + \mu_1} \begin{bmatrix} -\lambda_1(\lambda_1 + \mu_1 - \mu_2) \\ \lambda_1(\lambda_1 + \mu_1 - \mu_2) \\ \lambda_1\lambda_2 \end{bmatrix} + \frac{c}{s + \lambda_2 + \mu_2} \begin{bmatrix} -(\lambda_2 + \mu_2 - \mu_1)\lambda_2 \\ \lambda_1\lambda_2 \\ (\lambda_2 + \mu_2 - \mu_1)\lambda_2 \end{bmatrix} \tag{14}$$

$$P(t) = a \begin{bmatrix} \mu_1\mu_2 \\ \lambda_1\mu_2 \\ \lambda_2\mu_1 \end{bmatrix} + b \begin{bmatrix} -\lambda_1(\lambda_1 + \mu_1 - \mu_2) \\ \lambda_1(\lambda_1 + \mu_1 - \mu_2) \\ \lambda_1\lambda_2 \end{bmatrix} e^{-(\lambda_1 + \mu_1)t} + c \begin{bmatrix} -(\lambda_2 + \mu_2 - \mu_1)\lambda_2 \\ \lambda_1\lambda_2 \\ (\lambda_2 + \mu_2 - \mu_1)\lambda_2 \end{bmatrix} e^{-(\lambda_2 + \mu_2)t} \tag{15}$$

where a, b, c is the constant numbers, and their values are calculated based on (16).

$$\begin{cases} a = \frac{1}{(\lambda_1 + \mu_1)(\lambda_2 + \mu_2)} \\ b = \frac{1}{(\lambda_1 + \mu_1)[(\lambda_2 + \mu_2) - (\lambda_1 + \mu_1)]} \\ c = \frac{1}{(\lambda_2 + \mu_2)[(\lambda_1 + \mu_1) - (\lambda_2 + \mu_2)]} \end{cases} \tag{16}$$

It can be verified that $\sum_{i=0}^n P_i(t) = 1$, where n is the totally number of the system states [4]. Further, when the time t tends to 0, P_0 tends to 1, and P_1 and P_2 tend to 0. On the other hand, when time t approaches the positive infinity, the probability of the system under normal working state P_s and abnormal working state P_F are given as:

$$P_s = P_0(\infty) = \frac{\mu_1\mu_2}{\lambda_1\mu_2 + \lambda_2\mu_1 + \mu_1\mu_2} \tag{17}$$

$$P_F = P_1(\infty) + P_2(\infty) = \frac{\lambda_1\mu_2 + \lambda_2\mu_1}{\lambda_1\mu_2 + \lambda_2\mu_1 + \mu_1\mu_2} \tag{18}$$

Hence, the system average availability indicator A_m are given in (19) and (20).

$$A(t) = P_0(t) = \frac{\mu_1\mu_2}{\lambda_1\mu_2 + \lambda_2\mu_1 + \mu_1\mu_2} + \frac{-\lambda_1(\lambda_1 + \mu_1 - \mu_2)}{(\lambda_1 + \mu_1)[(\lambda_2 + \mu_2) - (\lambda_1 + \mu_1)]} e^{-(\lambda_1 + \mu_1)t} + \frac{-\lambda_2(\lambda_2 + \mu_2 - \mu_1)}{(\lambda_2 + \mu_2)[(\lambda_1 + \mu_1) - (\lambda_2 + \mu_2)]} e^{-(\lambda_2 + \mu_2)t} \tag{19}$$

$$A_{ms}(t) = \frac{1}{t} \int_0^t P_0(t) dt = \frac{\mu_1\mu_2}{(\lambda_1 + \mu_1)\mu_2 + \lambda_2\mu_1} + \frac{\lambda_1(\lambda_1 + \mu_1 - \mu_2)}{t(\lambda_1 + \mu_1)^2 [(\lambda_2 + \mu_2) - (\lambda_1 + \mu_1)]} (1 - e^{-(\lambda_1 + \mu_1)t}) + \frac{\lambda_2(\lambda_2 + \mu_2 - \mu_1)}{t(\lambda_2 + \mu_2)^2 [(\lambda_1 + \mu_1) - (\lambda_2 + \mu_2)]} (1 - e^{-(\lambda_2 + \mu_2)t}) \tag{20}$$

C. Reliability analysis based on three state Markov chain process

Compared with the two state Markov chain which is suitable for reliability analysis of a simple repairable system, the proposed three state Markov chain can use the series-parallel relationship of the components in the system to simplify the calculation process. It can not only achieve the quantitative calculation of the reliability index of the complex system, but also greatly reduce the computational complexity.

The reliability analysis procedure is illustrated in Fig.3.

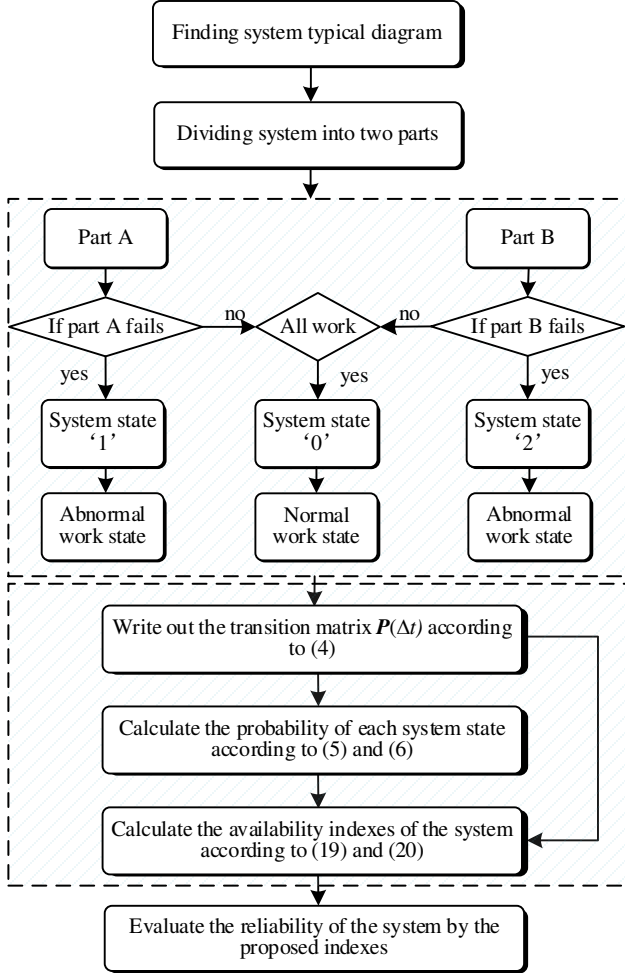

Fig. 3. Complex system reliability analysis process based on Markov chain

For a complex system containing multiple components or subsystems, the steps to quantitatively calculate the reliability indices of the Markov chains are shown as follows.

1) Build the system configuration diagram, divide the system into two parts according to their system functionalities, and then define normal and abnormal working states of different parts.

2) Define a homogeneous Markov chain $X(t)$, formulate the transition matrix $P(\Delta t)$, and the instantaneous, steady state and average availability indices of the system.

3) Calculate the instantaneous, steady state and average availability index of the system using the formulas derived in step 2 and output the system reliability analysis results with those indices values.

III. CASE STUDY

To verify the effectiveness of the proposed approach for the reliability analysis of the railway TPSS, the proposed three state Markov Chain method is applied to a typical TPSS as a case study. Fig. 4 illustrates the typical system topology of a railway substation system including bus line, transformers, rectifiers, circuit breakers, and isolating switches.

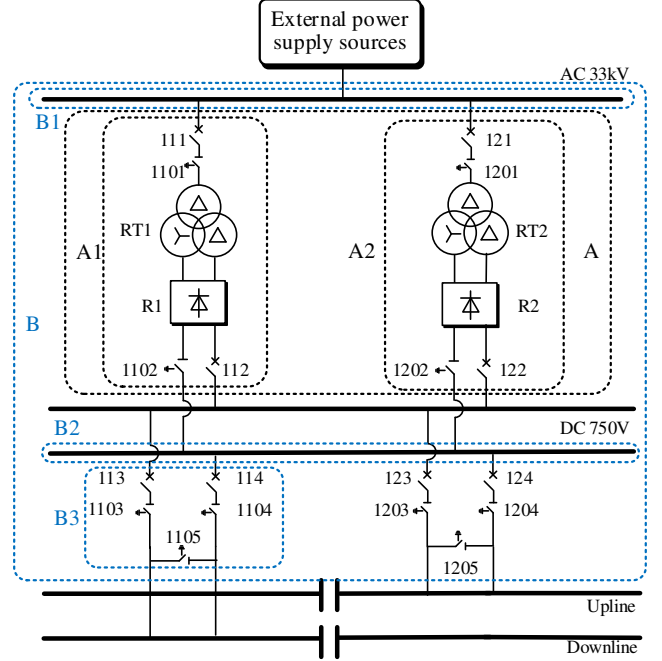

Fig. 4. The diagram of a typical railway traction power supply system

In most reliability studies, the railway TPSS default equipment failure and repair function obey the exponential distribution [8]. The reference data of the key equipment of the traction substation can be referred to [9], and the specific values are listed in Table I, the unit is per hour. This case assumes that the same type of equipment has the same probability of failure in the same traction substation.

TABLE I. FAILURE RATE AND REPAIR RATE OF MAIN EQUIPMENT OF RAILWAY TPSS

Equipment	Failure rate λ	Repair rate μ
Breaker	2.5114×10^{-6}	1/4
Isolating switch	1.7837×10^{-6}	1/4
Transformer	1.83×10^{-4}	1/24
Rectifier	9.134×10^{-6}	1/24
33 kV bus	2.354×10^{-8}	1/4
1500 V bus	1.354×10^{-8}	1/24

The system configuration can be divided into two parts, namely part A, and part B as shown in Fig.4. Then, the failure rate and repair rate of each part can be calculated according to its series-parallel relationship and these values are fed to the equations for formulating the reliability index.

TABLE II. RELIABILITY INDEX UNDER DIFFERENT SYSTEM STATES

Index	System
Availability (steady-state)	0.999963
Availability (instantaneous)	$P_0(t) = 0.999963 + 2.14210 \times 10^{-5} \times e^{-0.08848t} + 1.50979 \times 10^{-5} \times e^{-0.24104t}$
Average availability	$A_{ms}(t) = \frac{1}{t} \int_0^t P_0(t) dt$ $= 0.999963 + \frac{2.5236 \times 10^{-4}}{t} \times (1 - e^{-0.08856t})$ $+ \frac{6.2657 \times 10^{-5}}{t} \times (1 - e^{-0.08848t})$

(A) RELIABILITY INDEX OF SYSTEM

Index	Part A
Probability (steady-state)	2.14212×10^{-5}
Probability (instantaneous)	$P_1(t) = 2.14212 \times 10^{-5} - 2.14205 \times 10^{-5} \times e^{-0.08848t}$
Average probability	$A_{m1}(t)$ $= \frac{1}{t} \int_0^t P_1(t) dt = 2.14212 \times 10^{-5} - \frac{2.42100 \times 10^{-4}}{t} (1 - e^{-0.08848t})$

(B) RELIABILITY INDEX OF SYSTEM PART A

Index	Part B
Probability (steady-state)	1.50974×10^{-5}
Probability (instantaneous)	$P_2(t) = 1.50974 \times 10^{-5} - 1.50979 \times 10^{-5} \times e^{-0.24104t}$
Average probability	$A_{m2}(t)$ $= \frac{1}{t} \int_0^t P_2(t) dt = 1.50974 \times 10^{-5} - \frac{6.26365 \times 10^{-5}}{t} (1 - e^{-0.24104t})$

(C) RELIABILITY INDEX OF SYSTEM PART B

According to the proposed three state Markov chain method, the system reliability indicators calculated are listed in Tables II. Table II (A), (B), (C) quantitatively represent the instantaneous and steady state values of part A, part B and the whole railway traction power supply system in terms of availability and failure probability.

Functions in the Table II are the stable and instantaneous availability indices of the system and the failure probability of part A and part B. It can be easily inferred that the steady-state availability of parts A and B tends to be 99.9978% and 99.9985% respectively. Furthermore, as shown in Figure 5, the system average availability and the probability of part A and B vary with time. During the first 600 hours of operation, system availability decreases over time, and finally approaches to a steady state value. The availability of whole system reaches 0.999963 which implies that the system operation can still keep reliable operations, and the failure probability of part A and part B reaches 2.14212×10^{-5} and 1.50974×10^{-5} respectively.

Compared with two state Markov Chain method, the proposed method leads to rich set of reliability indices, such as probability of different system regions, which cannot be derived by two state Markov Chain method. However, adopting more system states must lead to extra and unacceptable computational burdens.

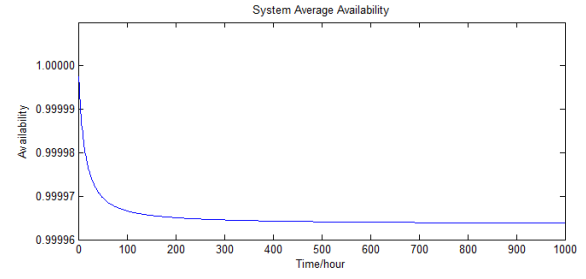

(A) AVERAGE AVAILABILITY OF SYSTEM

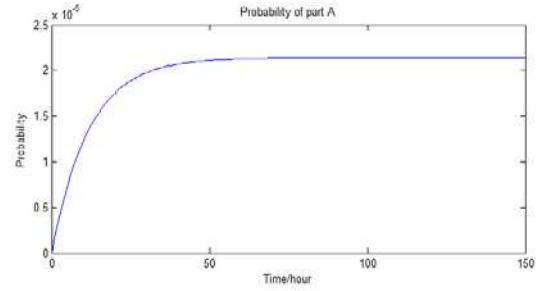

(B) PROBABILITY OF SYSTEM PART A

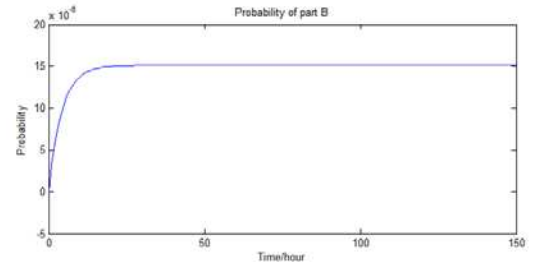

(C) PROBABILITY OF SYSTEM PART B

Fig. 5. System average availability and probability of part A and B

For example, defining system as four and more state Markov chain model with a higher-dimensional matrix structure leads to huge computational burden for Laplace and adverse transformation, hence it becomes less attractive to conduct the reliability calculation for complex systems. On the other hand, lower-order Markov chain cannot offer a desirable suite of reliability indexes to evaluate complex system. Therefore, three state Markov chain is good trade-off method for analyzing complex system reliability.

IV. CONCLUSION

Quantitative evaluation of reliability for TPSS is vital for safe and reliable operation of railway systems, and it is an important prerequisite for system maintenances plans. This paper has proposed a complex reliability analysis method based on three state Markov Chain by dividing the complex system into two regions. Based on the three state Markov Chain, the typical railway TPSS state transition diagram is established, and Laplace transformation is used to calculate the system stable, instantaneous, and average availability index for reliability analysis. Through the improved model and the derived indexes, the system reliability can be better analyzed. A case study to analyze the reliability of a typical TPSS shows that this method can not only greatly reduce the complexity of calculation, but also can obtain the whole system availability and the fault probability of the different system parts. This allows a better maintenance planning of complex railway systems.

ACKNOWLEDGMENT

This work is partially funded by the China Scholarship Council to Wei Zuo for sponsoring her PhD study at University of Leeds.

REFERENCES

- [1] H. Wang, Y. -P. Fang and E. Zio, "Risk Assessment of an Electrical Power System Considering the Influence of Traffic Congestion on a Hypothetical Scenario of Electrified Transportation System in New York State," in *IEEE Transactions on Intelligent Transportation Systems*, vol. 22, no. 1, pp. 142-155, Jan. 2021, doi: 10.1109/TITS.2019.2955359.
- [2] S. Lin, D. Feng and X. Sun, "Traction Power-Supply System Risk Assessment for High-Speed Railways Considering Train Timetable Effects," in *IEEE Transactions on Reliability*, vol. 68, no. 3, pp. 810-818, Sept. 2019, doi: 10.1109/TR.2019.2896127.
- [3] Y. Huang, X. Pan and L. Hu, "Rapid assessment of system-of-systems(SoS) mission reliability based on Markov chains," 2015 First International Conference on Reliability Systems Engineering (ICRSE), 2015, pp. 1-6, doi: 10.1109/ICRSE.2015.7366452.
- [4] K. Hou, H. Jia, X. Xu, Z. Liu and Y. Jiang, "A Continuous Time Markov Chain Based Sequential Analytical Approach for Composite Power System Reliability Assessment," in *IEEE Transactions on Power Systems*, vol. 31, no. 1, pp. 738-748, Jan. 2016, doi: 10.1109/TPWRS.2015.2392103.
- [5] L. Cui, Y. Xu and X. Zhao, "Developments and Applications of the Finite Markov Chain Imbedding Approach in Reliability," in *IEEE Transactions on Reliability*, vol. 59, no. 4, pp. 685-690, Dec. 2010, doi: 10.1109/TR.2010.2054172.
- [6] M. Althoff and A. Mergel, "Comparison of Markov Chain Abstraction and Monte Carlo Simulation for the Safety Assessment of Autonomous Cars," in *IEEE Transactions on Intelligent Transportation Systems*, vol. 12, no. 4, pp. 1237-1247, Dec. 2011, doi: 10.1109/TITS.2011.2157342.
- [7] K. Li, Q. Yang, Z. Cui, Y. Zhao and S. Lin, "Reliability Evaluation of a Metro Traction Substation Based on the Monte Carlo Method," in *IEEE Access*, vol. 7, pp. 172974-172980, 2019, doi: 10.1109/ACCESS.2019.2957151.
- [8] L. Sheng, L. Xiaohong, and F. Wei, "Reliability evaluation of relay protection for traction substation of urban rail transit," *J. Southwest Jiaotong Univ*, vol. 53, no. 6, pp. 1 8, 2018.
- [9] D. Feng, S. Lin, Q. Yang, X. Lin, Z. He and W. Li, "Reliability Evaluation for Traction Power Supply System of High-Speed Railway Considering Relay Protection," in *IEEE Transactions on Transportation Electrification*, vol. 5, no. 1, pp. 285-298, March 2019, doi: 10.1109/TTE.2018.2870293.

Authors' background (This form is only for submitted manuscript for review) *This form helps us to understand your paper better, the form itself will not be published. **Please delete this form on final papers.** *Title can be chosen from: master student, Phd candidate, assistant professor, lecture, senior lecture, associate professor, full professor.

Your Name	Title*	Affiliation	Research Field	Personal website
Wei Zuo	Phd candidate	elwz@leeds.ac.uk	Electrical railway traction power supply system reliability analysis	