



This is a repository copy of *Low salinity waterflooding in carbonate reservoirs: review of interfacial mechanisms*.

White Rose Research Online URL for this paper:  
<https://eprints.whiterose.ac.uk/180555/>

Version: Published Version

---

**Article:**

Derkani, M., Fletcher, A., Abdallah, W. et al. (3 more authors) (2018) Low salinity waterflooding in carbonate reservoirs: review of interfacial mechanisms. *Colloids and Interfaces*, 2 (2). 20. ISSN 2504-5377

<https://doi.org/10.3390/colloids2020020>

---

**Reuse**

This article is distributed under the terms of the Creative Commons Attribution (CC BY) licence. This licence allows you to distribute, remix, tweak, and build upon the work, even commercially, as long as you credit the authors for the original work. More information and the full terms of the licence here:  
<https://creativecommons.org/licenses/>

**Takedown**





If you consider content in White Rose Research Online to be in breach of UK law, please notify us by emailing [eprints@whiterose.ac.uk](mailto:eprints@whiterose.ac.uk) including the URL of the record and the reason for the withdrawal request.



[eprints@whiterose.ac.uk](mailto:eprints@whiterose.ac.uk)  
<https://eprints.whiterose.ac.uk/>

Review

# Low Salinity Waterflooding in Carbonate Reservoirs: Review of Interfacial Mechanisms

Maryam H. Derkani <sup>1</sup> , Ashleigh J. Fletcher <sup>1,\*</sup> , Wael Abdallah <sup>2</sup> , Bastian Sauerer <sup>2</sup>,  
James Anderson <sup>3</sup>  and Zhenyu J. Zhang <sup>4,\*</sup> 

<sup>1</sup> Department of Chemical and Process Engineering, University of Strathclyde, Glasgow G1 1XJ, UK; maryam.derkani@strath.ac.uk

<sup>2</sup> Schlumberger Middle East, S.A., Schlumberger Dhahran Carbonate Research Center, Dhahran Techno Valley, P.O. Box 39011, Dammam 31942, Saudi Arabia; WAbdallah@slb.com (W.A.); BSauerer@slb.com (B.S.)

<sup>3</sup> Chemical and Materials Engineering Group, School of Engineering, University of Aberdeen, Aberdeen AB24 3UE, UK; j.anderson@abdn.ac.uk

<sup>4</sup> School of Chemical Engineering, University of Birmingham, Birmingham B15 2TT, UK

\* Correspondence: ashleigh.fletcher@strath.ac.uk (A.J.F.); z.j.zhang@bham.ac.uk (Z.J.Z.)

Received: 15 March 2018; Accepted: 8 May 2018; Published: 18 May 2018



**Abstract:** Carbonate rock reservoirs comprise approximately 60% of the world's oil and gas reserves. Complex flow mechanisms and strong adsorption of crude oil on carbonate formation surfaces can reduce hydrocarbon recovery of an oil-wet carbonate reservoir to as low as 10%. Low salinity waterflooding (LSW) has been confirmed as a promising technique to improve the oil recovery factor. However, the principal mechanism underpinning this recovery method is not fully understood, which poses a challenge toward designing the optimal salinity and ionic composition of any injection solution. In general, it is believed that there is more than one mechanism involved in LSW of carbonates; even though wettability alteration toward a more desirable state for oil to be recovered could be the main cause during LSW, how this alteration happens is still the subject of debate. This paper reviews different working conditions of LSW, previous studies, and field observations, alongside the proposed interfacial mechanisms which affect the colloidal interactions at oil–rock–brine interfaces. This paper provides a comprehensive review of studies on LSW in carbonate formation and further analyzes the latest achievements of LSW application in carbonates, which helps to better understand the challenges involved in these complicated multicomponent systems and potentially benefits the oil production industry.

**Keywords:** enhanced oil recovery; wettability alteration; recovery factor; surface charge; electric double layer; multicomponent ion exchange; fluid–fluid interactions

## 1. Introduction

Maximizing the amount of crude oil extracted from existing reservoirs is vital for the oil and gas industry to increase its profitability and sustainability. However, studies [1,2] have shown that about 70% of global oil reserves cannot be extracted using conventional oil recovery techniques. It is also suggested that improving the global oil recovery factor by only 1% has the potential to produce an extra 88 billion barrels of oil, equal to three years of annual oil production, at current rates [3]. In principle, all hydrocarbon recovery operations involve three phases. During the primary oil recovery phase, the natural pressure within the reservoir pushes the oil out from the oil well. This stage can generally extract only 10% of available oil reserves in the reservoir. During the secondary oil recovery phase, also known as improved oil recovery (IOR), waterflooding is commonly used to provide pressure support and improve the sweep efficiency [2]. Conventional oil recovery phases, including both the

primary and secondary phases, can only extract a maximum of 30–35% of the available hydrocarbon from oil reservoirs [1]. During the tertiary oil recovery phase, also known as enhanced oil recovery (EOR), chemicals flooding (polymers, alkaline, and surfactants), miscible flooding (carbon dioxide, liquefied petroleum gases, methane, and nitrogen), thermal flooding (steam), microbial flooding (microorganisms), or a combination of them, are introduced, which helps the flow of the oil trapped in the reservoir rock by decreasing both the surface tension and viscosity of the crude oil [1,2,4,5]. This could be achieved by single or multiple changes of reservoir fluids properties and its interfacial energy. The application of each technique depends on the reservoir conditions, such as viscosity of the crude oil, brine salinity, rock permeability, as well as reservoir depth (temperature). EOR processes can recover an additional 5–20% of the original oil in place (OOIP), so that the total oil recovery can be improved potentially up to 50–70% depending on specific reservoir conditions [3].

During the secondary oil recovery phase, waterflooding (formation water) is conventionally used to maintain reservoir pressure above the bubble point pressure of the oil, improve sweep efficiency, and displace oil by water by taking advantage of viscous force [2,3]. It was first shown that either altering the brine composition or reducing the salinity of injected brine below that of the initial formation water can lead to additional oil recovery for Berea sandstone [6–12]. Such results attracted many oil and gas companies, such as British Petroleum [13–19], Shell [20–26], ExxonMobil [27,28], Schlumberger [29–31], TOTAL [32,33], and Statoil [34,35] to investigate and further explore the potential and applicability of low salinity waterflooding (LSW) for improved oil recovery. LSW, also known as designer waterflood, advanced ion management, and smart waterflooding, injects brine with controlled ionic concentration and composition (also known as smart water or dynamic water) into the well [17,20,27]. The devised formulation destabilizes the equilibrium of the initial oil–rock–brine system, which results in alteration of initial wettability conditions, and has a positive influence on the capillary pressure and relative permeability [3]. LSW can produce up to 10% extra crude oil compared to simple waterflooding methods [1]. During LSW, no expensive chemicals are added; therefore, this technique is cheap and environmentally friendly, and has no associated injection issues. Additionally, it is economically efficient to use LSW improved recovery from the start of the waterflooding process [3].

Water treatment processes for LSW are performed over two stages: nanofiltration and reverse osmosis. In the nanofiltration process, contaminations, such as sulphate, as well as other divalent ions, are removed to decrease the hardness of the brine and the probability of membrane blockage in the reverse osmosis process [3]. During the reverse osmosis process, salinity is reduced by removing salts from the injected brine. LSW permits variations in the operation window of key parameters allowing customization of the ionic concentration and composition of the injected brine, making it suitable for a particular reservoir condition, with the consideration of the clay swelling and reservoir souring, also to prevent corrosion and aerobic bacterial issues. The advantage of this technology is its lower operating and capital costs compared to most EOR processes [16,36–38]. Additionally, LSW is not only applicable from the early stages of the oil recovery process (unlike EOR techniques), but can also be applied during the late life cycle of the reservoir [36,37]. LSW techniques can also be used alongside chemical and thermal EOR processes. Studies show that using low salinity water, instead of sea water, in polymer flooding processes can decrease polymer consumption considerably (5–10 times), which is additional to the potential benefits of LSW itself [39]. Appropriate implementation of LSW could potentially improve hydrocarbon recovery efficiencies up to 40% of OOIP, corresponding to a reduction in residual oil saturation of up to 20% pore-volume [36,40–43]. LSW has been demonstrated as a promising approach to improve the oil recovery factor and it can be used both onshore and offshore. However, inconsistent and conflicting results about efficiency of this technique have been reported in literature. Additionally, the principal mechanism underpinning this technique is not yet fully understood and poses a challenge in designing and optimizing the salinity and ionic composition of the injected brine.

Approximately 60% of the world's oil reserves are found in carbonate fields (limestone, chalks, and dolomites) with a large portion located in the Middle East; these comprise 75% of oil and

90% of gas reserves for the region [44,45]. Carbonates are sedimentary rocks formed of minerals, including those predominately containing carbonate ions, e.g., calcite and dolomite [46]. Carbonate rock may also contain aragonite, anhydrite, phosphate, glauconite, chert, quartz, pyrite, ankerite, clay minerals, and siderite [44]. It is likely that carbonate rocks undergo dissolution, recrystallization, and mineralogical replacement by varying the temperature, pressure, and pore-fluid chemistry [44]. Limited knowledge with regards to the petrophysical properties of carbonate reservoir, such as heterogeneity, porosity, permeability, and wettability, is one of the greatest challenges that the oil industry is facing to manage such reservoirs and maximize its oil recovery factor [44]. Carbonate surfaces are originally water-wet, containing positively charged surface electrostatics over a wide range of pH [47]. However, adsorption of negatively charged carboxylic materials ( $-\text{COO}^-$ ), present in the heavy end fractions of crude oil such as resin and asphaltene fractions, onto positively charged carbonate rock surfaces, results in large crude oil particles covering the carbonate surface and could promote mixed-wet or oil-wet characteristics [45,47–50]. Carbonate reservoir rocks have inherently higher chemical activities compared to minerals in sandstone reservoirs (quartz); additionally, there have been difficulties in modelling the distribution of permeability in carbonates and predicting reservoir behaviour, due to poor correlation between permeability and porosity. Researchers have also reported the presence of fractures, and large-scale heterogeneity, which generates complex paths available for fluid flow [51]; thus, the combination of these factors, as well as reduced water wetness, results in low oil recovery (30–10%) from oil-wet carbonate reservoirs [52,53].

Extensive studies on the application of LSW in both sandstone [9–13,18,54–57] and carbonate [58–62] reservoirs have been reported in the literature. However, the effect of LSW at field scale was not observed in carbonates until the recent work by Yousef and colleagues [37], where they conducted coreflooding experiments under reservoir conditions and executed successful field trials. Implementation of LSW in carbonate reservoirs has received inconsistent feedback compared to sandstone reservoirs. This is most likely due to the carbonate heterogeneity and considerably high bonding energy between carbonate surface and polar components in crude oil, in comparison with more homogeneous sandstone formations, as well as a deficiency of clay and certain minerals in carbonates [55,60]. Although improvement of oil recovery in carbonates was reported by using LSW injection [15,20,38,52,61,63–68], a few studies [69,70] reported failure in improving oil recovery efficiency when seawater or diluted seawater was used. Moreover, Fathi and coworkers [65] observed a reduction in oil recovery for outcrop chalk cores, from 60% to 15% of OOIP, by using diluted seawater compared to seawater, due to a decrease in active ions.

Improved oil recovery was observed in both secondary mode (at initial formation water saturation) and tertiary mode (after seawater residual saturation) [46,57,71,72], or solely in the secondary LSW mode [57,73–75]. No specific temperature range has been proposed for performing LSW, despite that the process is mostly carried out at temperatures of less than 100 °C [60,76]. Even though very low concentrations (up to 5 kppm) of total dissolved solids (TDS) have been proposed for LSW in sandstones [16,41,76,77], there are other works whereby improved oil recovery in carbonates was achieved by a considerably higher salinity of injected brine (up to 33 kppm) [60,65]. It is suggested that LSW in carbonates can improve oil recovery even at higher salinity of the injected brine, as long as it contains a different relative concentration of active ions compared to the formation water.

A survey of the literature shows that the wetting condition of a carbonate rock can be altered by increasing the concentration of divalent anion (e.g.,  $\text{SO}_4^{2-}$ ), decreasing the concentration of divalent cations ( $\text{Ca}^{2+}$  or  $\text{Mg}^{2+}$ ), reducing the salinity of brine, or removing sodium chloride (NaCl) from seawater [62,78,79]. For example, it was reported that removing sodium chloride from the injection brine and increasing  $\text{SO}_4^{2-}$  concentration, at high temperature (above 90 °C), could modify the rock wettability significantly, improving oil recovery from 37% to 62% of OOIP from chalk cores, compared to original seawater flooding [79]. Depending on the characteristics of the crude oil, the reservoir condition, and the properties of the formation brine, several mechanisms have been suggested to interpret LSW in carbonate reservoirs. The primary mechanisms proposed include fines

migration, rock dissolution, reduction of interfacial tension (IFT), fluid–fluid interaction and formation of microemulsions, multicomponent ionic exchange (MIE), and expansion of electric double layer (EDL) [46,80–84]. The desirable condition for enhanced oil recovery could be due to an alteration in the wettability of the rock, which is determined by the thickness and stability of a water film between the rock surface and crude oil. It is generally accepted that LSW disturbs the pre-established thermodynamic equilibrium between rock, formation water and oil interfaces and facilitates a new chemical equilibrium, which modifies the wetting properties towards a more desirable condition to improve oil recovery from reservoir rock pores. The wettability alteration is affected by temperature, pressure, pore water and crude oil chemistry [85]. In general, it is believed that there is more than one mechanism involved in LSW of carbonates; wettability alteration could be the main cause during LSW, although how this alteration happens is still the subject of debate. Understanding the colloidal interactions at oil–rock–brine interfaces, the underlying physiochemical mechanisms involved in LSW, as well as detecting its suitability to a specific type of reservoir, are essential before implementing this technique to a given carbonate reservoir.

This paper provides a critical review on LSW in carbonate reservoirs by discussing different variables involved in this technique, such as reservoir and the injected brine parameters, previous experimental and theoretical studies on surface wettability, interfacial tension and recovery factors, as well as field observations, and finally the proposed interfacial mechanisms. Our review summarizes and further analyzes the latest achievements of LSW in carbonates, which helps to better understand the challenges involved in these complicated multicomponent systems, and potentially benefits the oil industry.

## 2. Working Conditions

Based on previous studies, various conditions have been suggested to affect oil recovery improvement during LSW in carbonate formations, such as specific reservoir conditions, oil–rock–brine properties, and well pattern. Both reservoir and the injected brine parameters are summarized in this section.

### 2.1. Reservoir Parameters

#### 2.1.1. Formation Water Composition and pH

The composition of the formation (connate) water in reservoirs and its pH can influence the efficiency of oil recovery by affecting the initial rock wettability and interactions with the injected brine. The charge of rock–brine interfaces is affected by potential determining ions (PDIs) present in the formation water, as well as the pH of the formation water [58]. Natural pH of formation water in carbonate reservoirs is slightly basic (7–8) [58,61]. However, due to the high buffer capacity of calcium carbonate from the formation water, the pH remains unchanged, due to chemical equilibrium at the oil–rock–brine interface. Thus, it is suggested that wettability alteration, as a result of pH variation is temporary [61]. Table 1 shows the variation in composition of brine (formation water and seawater) in different regions, such as the Persian Gulf, Ekofisk and common areas [3,30,38,86]. Formation water is usually extremely saline (up to 250 kppm), and contains a high concentration of  $\text{Ca}^{2+}$  ions, but much lower concentration  $\text{Mg}^{2+}$  ions. Additionally,  $\text{SO}_4^{2-}$  is known as the most active anion in altering wettability of carbonate rock. However, the concentration of  $\text{SO}_4^{2-}$  ions is very low, due to the high concentration of  $\text{Ca}^{2+}$  in the formation water, especially at high temperatures, which results in precipitation of anhydrite ( $\text{CaSO}_4$ ) [87]. Romanuka et al. [88] suggested that injection of seawater with high concentrations of surface interacting ions ( $\text{SO}_4^{2-}$ ,  $\text{BO}_3^{3-}$  or  $\text{PO}_4^{3-}$ ), with the presence of divalent cations, e.g., barium ( $\text{Ba}^{2+}$ ) and strontium ( $\text{Sr}^{2+}$ ), in formation water, can increase the chance of scale formation in the production lines and plugging of reservoir rock in the production well. Additionally, injection of seawater with high concentration of  $\text{SO}_4^{2-}$  can turn sweet oil fields to sour oil fields [89]. The interactions between small amounts of  $\text{SO}_4^{2-}$  dissolved in formation water and the rock surface using chalk cores at 20–130 °C was studied by Shariatpanahi et al. [87]. Their experimental results



showed that even small concentrations of  $\text{SO}_4^{2-}$  ions (up to 2 mmol/L) present in formation water can influence initial wetting conditions of carbonate rock reservoir considerably and alter it to a more water-wet state. Therefore, composition of the formation water in carbonate fields must be taken into account before designing the injected brine for LSW in order to prevent the chance of reservoir souring and plugging, and to be able to maximize oil production from a specific carbonate reservoir.

**Table 1.** Composition of the formation water and seawater compared in different regions (the Persian Gulf, Ekofisk, and common areas) [3,30,38,86].

Type Ionic Composition	Seawater (ppm)			Formation Water (ppm)		
	Persian Gulf	Ekofisk	Common	Persian Gulf	Ekofisk	Common
$\text{Na}^+$	18,040	10,345	10,890	59,491	15,745	31,275
$\text{K}^+$	0	390	460	0	0	654
$\text{Ba}^{2+}$	0	0	0	0	0	269
$\text{Ca}^{2+}$	650	521	428	19,040	9258	5038
$\text{Mg}^{2+}$	2160	1093	1368	2439	607	379
$\text{Sr}^{2+}$	10	0	0	0	0	771
$\text{SO}_4^{2-}$	4450	2305	2960	350	0	0
$\text{Cl}^-$	31,810	18,719	19,766	132,060	42,437	60,412
$\text{CO}_3^{2-}$	30	0	0	0	0	0
$\text{HCO}_3^-$	120	122	0	354	0	0
Total	57,270	33,497	35,872	213,734	68,050	98,798

### 2.1.2. Initial Water Saturation

Initial water saturation ( $S_{wi}$ ) is determined as the amount of water adsorbed on the surface of rock porous channels per pore-volume and exist as free water in the pore space [90]. It is suggested that reducing initial water saturation results in reduction of the water-wet condition for sandstone cores [8,91]. The effect of initial water saturation on wettability alteration of reservoir limestone cores was studied by Strand et al. [59], where their experimental results showed an increase in oil recovery of reservoir limestone cores by increasing the initial water saturation from 9.1% to 14.8%. They showed that the core with higher initial water saturation produced an additional 15% compared with OOIP. Similarly, Puntervold et al. [92] examined a range of initial water saturations, such as 100% oil saturation ( $S_{wi} = 0$ ), low initial water saturation ( $S_{wi} = 10\%$ ), and high initial water saturation ( $S_{wi} = 30\text{--}50\%$ ), where they observed a decrease in water wetness of chalk cores by decreasing the initial water saturation. By contrast, in their later published work [93], two different residual water saturations (10% and 22%) and a crude oil were used, where the experimental results showed no correlation between initial water saturation and improved oil recovery from chalk cores, as the authors observed 50% recovery for both cores. They suggested that initial water saturation has a negligible impact on wettability alteration of chalk cores.

### 2.1.3. Crude Oil Composition

An appropriate evaluation of crude oil composition is a prerequisite for any successful LSW process. Polarity of crude oil is related to the presence of heteroatoms such as sulphur, nitrogen, and oxygen, which are found in the functional groups of acidic and basic organic molecules in the crude oil, such as asphaltene and resins, which can affect rock wettability [94]. Asphaltenes are the most dense, most aromatic, and most polar component of crude oil, having a great importance in predicting the chemistry and properties of crude oil [95,96]. Asphaltenes have a complex nature and their molecular structures are not well known [97], and associated clogging in reservoir rock and oil wells, reduces oil production and has significant negative effects on the economics of this industry [98]. The amount of carboxylic material in crude oil can be quantified by the acid number (AN), determined as the number of milligrams of potassium hydroxide required to neutralize 1 g of crude oil (mg

KOH/g) [99]. The AN and the chemical properties of the carboxylic material in the crude oil can strongly affect the wetting properties of carbonate [100,101]. Austad and colleagues [61] suggested that low salinity effect is dependent on a mixed-wet state, and such influence increases as the AN of crude oil is increased. However, no direct correlation was established between the AN of a crude oil and improvement in oil recovery by LSW [55]. Standnes and Austad [102,103] showed that oil recovery and water wetness increases as the AN of the oil decreases (Figure 1). Even though the base number (BN) of crude oils are believed to have a minor impact on wettability alteration, Puntervold et al. [92] observed an improvement in water-wetness of chalk by increasing the BN of crude oil with a given AN. It was argued that the formation of an acid–base complex in the crude oil can make the acidic material less active toward the carbonate rock surface.

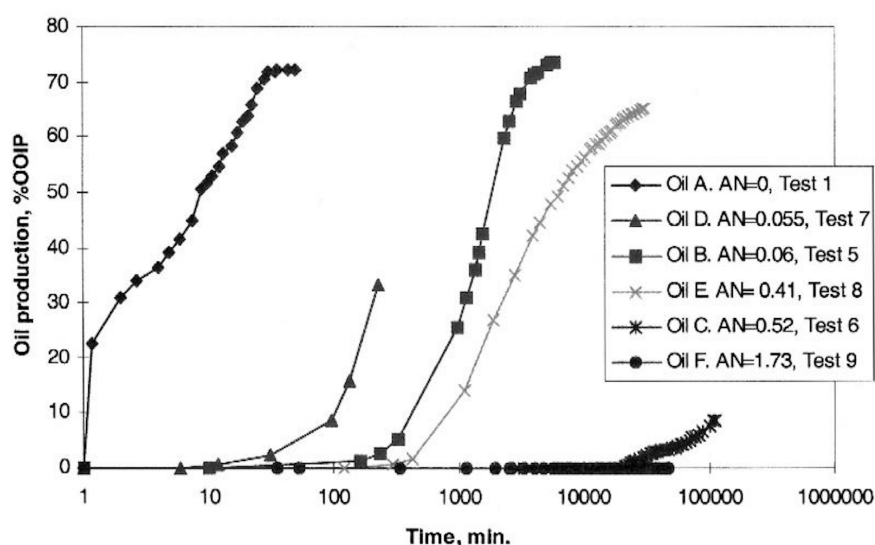

**Figure 1.** Oil production from a chalk core at 40 °C, when the core was saturated with crude oils with different AN from [102]. Reproduced with permission from Standnes and Austad, *J. Pet. Sci. Eng.*; published by Elsevier, 2000.

The effect of acidic material on wettability alteration of chalk was systematically examined by extracting water-soluble acids (naphthenic acids) from a crude oil with high AN [104]. The results indicate that the core, saturated with oil depleted in water-soluble acids, was more water-wet, showing that water-soluble acids can influence the stability of the initial water film at oil–rock interfaces. In a different study, Yi and Sarma [80] observed 17% additional LSW oil recovery by using a heavy oil, in comparison with 9% for a thin field oil. They attributed such difference to the ability of large molecules in the viscous oil to reach equilibrium with the rock surface and re-establish the mixed or oil-wet condition, as opposed to a thin oil, where wettability restoration would take a longer time and the final wettability state would be less oil-wet. This suggests that LSW can be more efficient in the case with heavier oil compared to lighter oil, as the more oil-wet initial state can be altered to a more water-wet condition and LSW has a higher chance to make a significant wettability alteration.

The effects of various chemical compounds (carboxylic acids, alcohols,  $\text{SO}_4^{2-}$ , sulphonates, amines, amino acids, and carboxylated polymers) on surface adsorption, and consequently modification of the rock wettability of carbonate minerals (calcite, dolomite, and magnesite), were investigated by Thomas and co-workers [105]. They reported that organic compounds can readily adsorb on carbonate surfaces from both organic and aqueous solvents and fatty acid can be adsorbed from aqueous solutions irreversibly. Additionally, it was found that carboxylic acids adsorb most strongly to the carbonate surface and their adsorption is stabilized by long straight chains, due to interactions between closed-packed hydrophobic layer, or by polymeric structures by providing multiple attachments

sites, altering the wettability of rock to strongly oil-wet. In a separate study [106], it was shown that long chain carboxylic acids (naphthenic acid) could alter the wettability of chalk to a more oil-wet condition, comparing to short chain fatty acids (acetic acid). Rezaei Gomari et al. [107] studied the effect of different fatty acids, such as short chain (heptanoic acid), long chain (stearic and oleic acids), and naphthenic acids (cyclohexane-pentanoic and decahydronaphthalene-pentanoic acids) on wettability alteration of calcite crystal surfaces. Their experimental results showed that long chain saturated stearic acid, as well as long chain unsaturated oleic acid, are by far the most effective among the studied acidic species to alter the calcite surfaces to a more oil-wet state. Therefore, higher AN of crude oil, as well as the presence of long chain carboxylic acids, are suggested to play role in wettability alteration of carbonate surfaces toward a more oil-wet state.

#### 2.1.4. Aging Time, Temperature, and Pressure

Reservoir temperature is an essential factor that affects the activation energy required for the chemical reaction for wettability improvement to occur by LSW [59]. Carbonate rock reservoirs are suggested to be more water-wet at higher temperatures [108]. It is believed that reservoir temperature and the AN of crude oil are related to each other: as the reservoir temperature increases, the AN decreases, due to increased decarboxylation of the acidic molecules at high temperature [109]. The effect of aging time and temperature on the wettability alteration of carbonate surfaces were studied by Heidari et al. [110], where they reached an intermediate-wet state at 50 °C after 10 days aging of carbonate slides, as opposed to 63 days aging at 25 °C. They suggested that aging is an essential parameter in wettability modification in order to produce similar oil-wet conditions to a reservoir; however they concluded that wettability of rock is mostly influenced by temperature rather than the time for which the core is aged with oil. Core preparation involves, first solvent cleaning using Dean–Stark extraction to remove contamination before petrophysical measurements (dimensions and porosity) and wettability restoration. Then, the core is saturated with the formation water under vacuum and permeability is determined by the formation water flooding using different flooding rates. Afterwards, crude oil is injected to the core to achieve initial water saturation, and the core plug is aged using steel aging cell under experimental temperature and pressure of about 200 psi [80]. For limestone core plugs to restore the reservoir wettability, Yi and Sarma suggested that, according to properties of the rock core and fluids, a minimum aging time of three weeks is required [80]: they suggested that a deficiency in aging time may result in improved oil recovery in the secondary oil recovery mode, but limited wettability modification in the tertiary mode. In contrast, it was suggested that aging time and temperature have a negligible impact on oil recovery from chalks, as the oil–rock–brine system reaches equilibrium quickly [111,112]. Pressure may also affect wettability of carbonate rock reservoirs, due to changes in solubility of compounds in the crude oil. Solubility of asphaltenes decreases, as the pressure decreases toward the bubble point of the crude oil, which results in precipitation and adsorption of the polyaromatic compounds on the rock surface [113].

#### 2.1.5. Rock Mineralogy

Different carbonate minerals, such as chalk, limestone (reservoir and outcrop), and dolomite possess different surface areas and available binding sites toward PDIs. Chalk and reservoir limestone cores are reactive toward the active ions present in seawater, resulting in wettability modification. However, reactivity of reservoir limestone cores toward PDIs ( $\text{Ca}^{2+}$ ,  $\text{Mg}^{2+}$ , and  $\text{SO}_4^{2-}$ ) can vary. For example, it was shown that wettability of oil-wet reservoir limestone cores can be improved by firstly cleaning with toluene and methanol, and then flooding with synthetic seawater at 130 °C, resulting in an improvement of the water-wet fraction by approximately 30% [114]. Furthermore, the results show that oil recovery from low permeable reservoir limestone was improved considerably, from 8% to 37% of OOIP, after switching the injected brine from formation water to seawater in both secondary and tertiary oil recovery modes. However, in a different investigation, Fathi and colleagues [115] showed that it was impossible to improve the water-wetness of an offshore oil-wet



reservoir limestone, even though the reservoir crude oil had a very low AN. Different behavior of outcrop limestone from reservoir limestone in a wettability modification process was shown by Ravari et al. [116]. Two outcrop limestones collected from different regions were examined, and both of them showed that wettability can be modified in the presence of crude oil. However, no reactivity toward PDIs was observed on the outcrop limestone surfaces, while wettability modification and improved oil recovery could not be obtained using seawater at high temperature. This could be due to outcrop limestone acting oil-wet without being in contact with oil, or outcrop limestone acting water-wet, but showing no reactivity towards PDIs due to structural differences between outcrop limestone with that of reservoir limestone, or due to adsorption of polymeric hydrophilic materials on the rock surface. It was concluded that care must be taken to use outcrop limestone as a model for carbonate reservoir rock in systematic studies of wettability alteration and oil recovery. However, even different sources of limestone showed different surface reactivity towards variation in brine salinity, which could be due to their different grain structure and degree of crystallinity [25]. Chalk is made of pure biogenic  $\text{CaCO}_3$  (fragmentary portions of calcite skeletons generated by plankton) and is known to have higher reactivity towards PDIs than limestone [59]. It is suggested that seawater has higher potential to act as a wettability modifier towards chalk surfaces compared to limestone [59]. NaCl depleted seawater was recognized as a better wettability modifier toward chalk surfaces than seawater [117]. Moreover, Austad et al. [62] observed no low salinity effect for chalk cores that do not contain anhydrite and suggested that much higher oil recovery (up to 20% of OOIP) in limestone cores can be obtained if the core contains a high amount of anhydrite. Similarly, even though Zahid et al. [69] observed considerable oil recovery improvement in a tertiary mode for reservoir carbonate (limestone) cores, by reducing concentration of seawater at 90 °C, they did not notice any oil recovery improvement in anhydrite free chalk cores. Additionally, different types of outcrop chalk cores are shown to have different degree of reactivity towards  $\text{SO}_4^{2-}$  ions [118]. Dolomite surfaces are suggested to behave similar to calcite surfaces in wettability alteration toward LSW [30,31,62,119]. However, it was suggested that, adsorption of stearic acid molecules on dolomite surfaces is stronger than on calcite surfaces, due to the positive surface charge of dolomite in diluted seawater [31]. Consequently, diluted seawater is less efficient in altering the surface charge of dolomite and releasing adsorbed carboxylic acid materials when compared to calcite [31]. Mahani and co-workers [25,26] explained that different carbonate rocks exhibited different surface reactivity and wettability alteration by variation in the brine salinity, pH, and temperature. It was shown that chalk surfaces had the highest surface reactivity towards alteration in brine concentration and pH, while dolomite surfaces showed the lowest [26]. Furthermore, a more noticeable improvement in wettability of dolomite surfaces at elevated temperature was observed compared to limestone surfaces [25]. Lastly, it is suggested that the optimal brine concentration for LSW that produces the highest oil recovery varies in different layers of the same reservoir and is dependant on the rock mineralogy and properties [22].

#### 2.1.6. Rock Porosity and Permeability

Carbonate reservoir wettability is also affected by rock porosity and relative permeability (the permeability difference between the fractures and the matrix block). Porosity is directly linked to the amount of oil in place and permeability is linked to the rate at which the crude oil can be recovered [105]. Evaluation of porosity and permeability in carbonates is multifarious, due to complex pore systems and their chemical reactivity. If the natural fractures have a high degree of connectivity, the viscous displacement of oil from the matrix blocks, by the injected brine, decreases, due to its negative impact on capillary pressure, which prevents brine imbibing spontaneously from the fractures through the matrix blocks. In contrast, displacement of oil from the matrix block, with injected brine, results in an increase in the water saturation in matrix blocks of a reservoir and relative permeability. Therefore, if the difference between permeability of the matrix and fractures is moderate, then a large pore-volume of seawater flows into the matrix blocks during waterflooding [120]. Naturally fractured outcrop chalk cores are characterized by their high porosity and low permeability. However, limestone

is less homogeneous than chalk, in terms of porosity and permeability, and has smaller surface area [121]. Korsnes and co-workers [122] studied the mechanical properties of high porosity outcrop chalk using synthetic seawater, modified seawater, and distilled water at 130 °C. Their experimental results showed an increase in compaction, by a factor of 2.7, when seawater, including  $\text{SO}_4^{2-}$  ions, was used, due to chemical reactions at the chalk surface, rather than pure chemical dissolution of chalk. Additionally, reductions in permeability, by a factor of 2.5, when brine contained  $\text{SO}_4^{2-}$  ions was observed compared to 1.7 for brine without  $\text{SO}_4^{2-}$ . They suggested that no considerable reduction in permeability, due to compaction of chalk with high porosity, was observed, by using different brines, and seawater does not alter permeability of the chalk even at high temperature. Even though porosity and permeability of carbonate rocks are important factors that influence oil recovery efficiency, additional previous studies on the effect of LSW on permeability and wettability alteration were not available in the open literature, hence, the discussion on their impact on oil recovery in carbonates could not be extended further.

## 2.2. Injected Brine Parameters

### 2.2.1. Ionic Composition and Temperature

The effects of  $\text{Ca}^{2+}$ ,  $\text{Mg}^{2+}$ , and  $\text{SO}_4^{2-}$ , three primary PDIs toward carbonate surfaces, have been extensively studied in the literature. It was reported [123] that increasing the concentration of  $\text{SO}_4^{2-}$  ions at four times the concentration present in seawater can improve oil recovery from chalk cores, from 15% to 55% of OOIP after 30 days at 70 °C (Figure 2a). In a similar work, Zhang and co-workers [111] reported that increasing the concentration of  $\text{Ca}^{2+}$  ions at four times the concentration present in seawater whilst keeping the  $\text{SO}_4^{2-}$  concentration the same as in the seawater, could increase oil recovery of chalk cores from 28% to 60% of the OOIP, after 30 days at 70 °C (Figure 2b). Additionally, they suggested that increasing the concentration of  $\text{Ca}^{2+}$  and  $\text{SO}_4^{2-}$  ions in seawater and the initial brine altered the wettability of chalk surfaces, and improved oil recovery. However, high concentrations of  $\text{Ca}^{2+}$  ions did not enhance oil recovery when cores were aged with a crude oil of high AN. The effect of  $\text{Ca}^{2+}$  and  $\text{SO}_4^{2-}$  ions on wettability modification of chalk surfaces were investigated, and it was found that adsorption of  $\text{SO}_4^{2-}$ , and co-adsorption of  $\text{Ca}^{2+}$ , onto chalk surfaces with increasing temperature, could result in enhanced water-wetness conditions and improved oil recovery [58,124]. However, the surface adsorption decreases as the ratio of  $\text{Ca}^{2+}/\text{SO}_4^{2-}$  increases, at temperatures beyond 100 °C, due to precipitation of anhydrite ( $\text{CaSO}_4$ ). Additionally, reduction of brine salinity and increasing concentration of  $\text{SO}_4^{2-}$  ions are shown to improve oil recovery in sandstone cores with a low clay content, containing high amount of dolomite and anhydrite and the interstitial dolomite crystals are argued to play a role in low salinity oil recovery mechanism [119].

Activity of  $\text{SO}_4^{2-}$ , as a PDI and wettability modifier of chalk surfaces, could increase as temperature increases from 70–130 °C [125]. Oil recovery from a chalk core at two different temperatures (100 °C and 130 °C) for a fixed oil by varying concentration of  $\text{SO}_4^{2-}$  ions in a synthetic seawater is shown in Figure 3 [123]. However, individual observations need to be carefully considered with respect to a system of interest as anticipated gains may not always be obtained (Figure 4) [111]. Systematic series of studies was carried out to investigate the effect of divalent cations ( $\text{Mg}^{2+}$  as well as  $\text{Ca}^{2+}$ ) and an anion ( $\text{SO}_4^{2-}$ ) on the wettability alteration of chalk surfaces [63,120,122,126]. They revealed that, at high temperatures (above 70 °C),  $\text{Mg}^{2+}$  can substitute  $\text{Ca}^{2+}$  on the chalk, and the quantity of carboxylate complexes and the degree of substitution increases as temperature increases. Similarly, it was shown that ( $\text{Mg}^{2+}$  ions can substitute  $\text{Ca}^{2+}$  on reservoir limestone cores at high temperature (130 °C), but the reactivity was less than for chalk [59]. It is possible that  $\text{SO}_4^{2-}$  cannot improve water-wetness and oil recovery alone in the absence of divalent cations ( $\text{Mg}^{2+}$  and  $\text{Ca}^{2+}$ ). Additionally, Chandrasekhar and Mohanty [43], as well as Shehata et al. [127], suggested that  $\text{Mg}^{2+}$  and  $\text{SO}_4^{2-}$  ions are more efficient than  $\text{Ca}^{2+}$  ions in wettability alteration and improved oil recovery of reservoir limestone. Figure 5 shows that the equilibria established with specific seawater concentrations can

be significantly affected by additional PDIs. Yi and Sarma [80] studied the effect of reducing ionic strength and increasing concentration of  $\text{SO}_4^{2-}$  ions on wettability alteration and oil recovery of reservoir limestone cores at 70–120 °C. They argued that, at 70 °C, lowering the concentration of brine is more efficient than increasing the concentration of  $\text{SO}_4^{2-}$  ions, whereas, at 120 °C, reducing water salinity and increasing  $\text{SO}_4^{2-}$  concentration resulted in much higher oil recovery. Additionally, at 90 °C, oil recovery can be improved by either lowering water salinity or increasing  $\text{SO}_4^{2-}$  concentration, while divalent cations had a negligible impact on wettability alteration [80]. However, it is shown that wettability of carbonate rock surfaces can be altered to a more water-wet state even at ambient temperature, depending on specific type of rock, and elevated temperature does not always lead to a more water-wet condition [25,128].

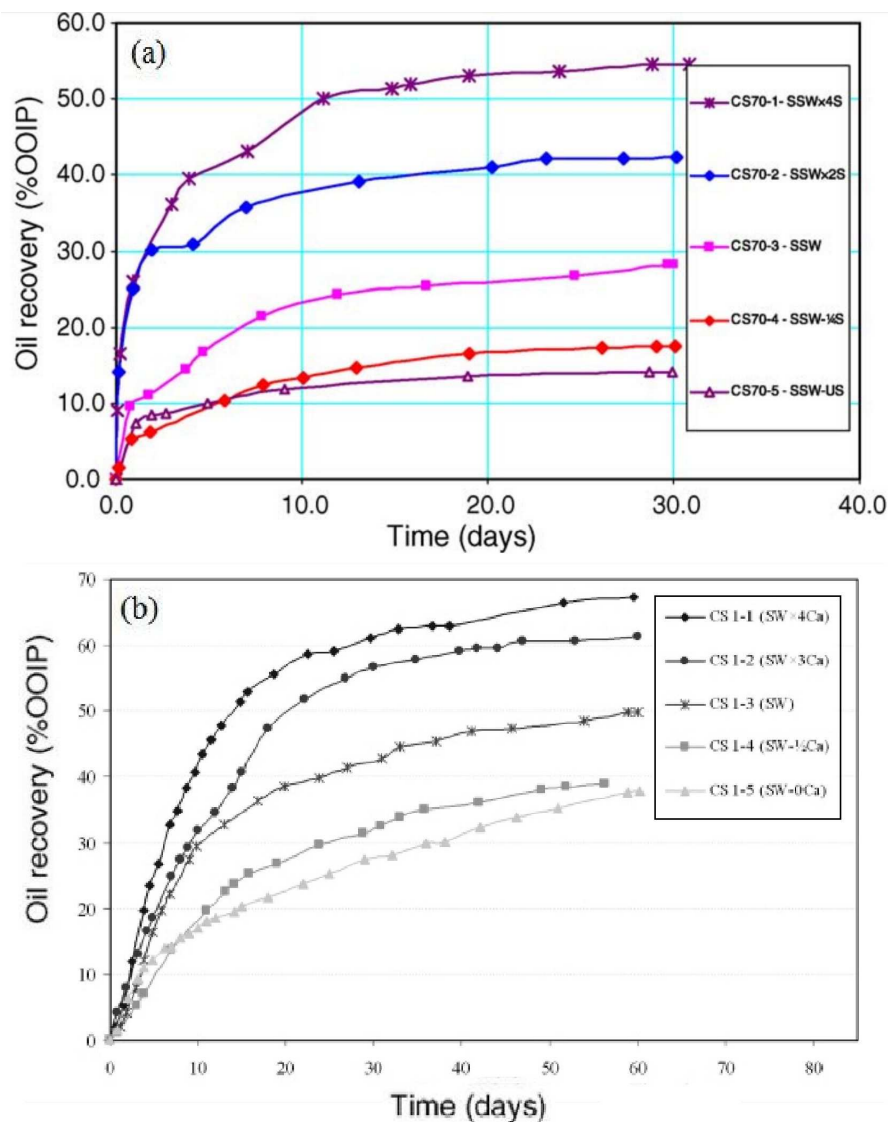

**Figure 2.** Oil recovery from a chalk core 70 °C when a synthetic seawater (SSW) with different concentrations of: (a)  $\text{SO}_4^{2-}$  (0–4 times the concentration present in synthetic seawater (SSW-US, SSW-1/2S, SSW, SSWx2S, and SSWx4S)) from [123] (reproduced with permission from Zhang et al., *Colloids Surf. A*; published by Elsevier, 2006); and (b)  $\text{Ca}^{2+}$  (0–4 times the concentration present in seawater (SW-0Ca, SW-1/2Ca, SW, SWx3Ca, and SWx4Ca)), but constant amount of  $\text{SO}_4^{2-}$  ions from [111] (reproduced with permission from Zhang et al., *Energy Fuels*; published by American Chemical Society, 2006), were used as imbibing fluids (AN = 0.55 mg KOH/g).

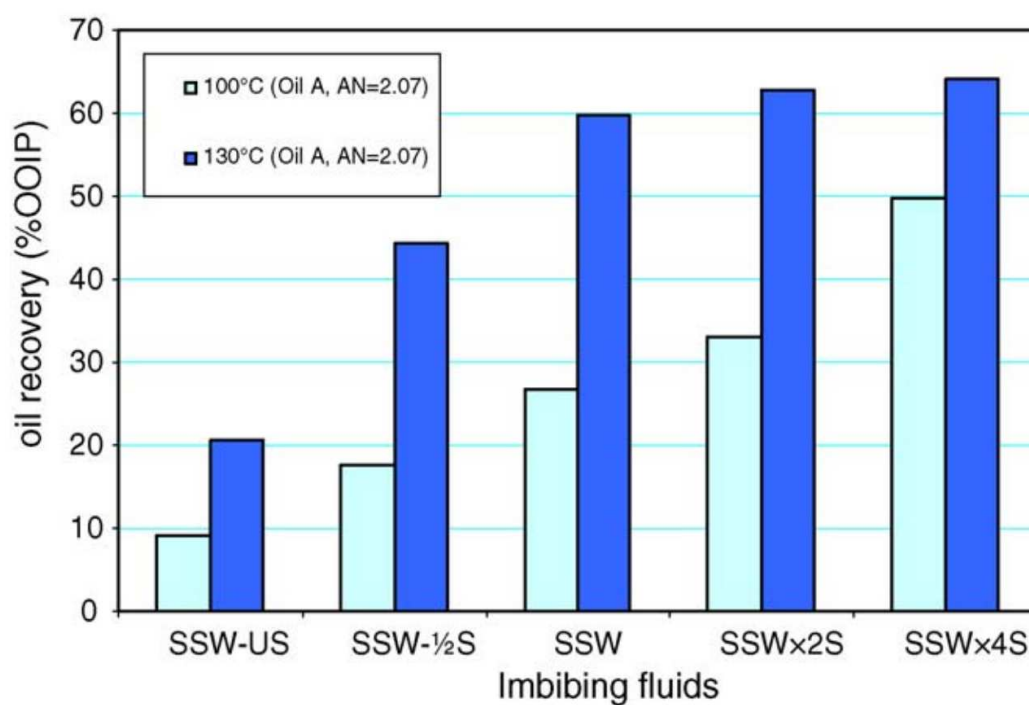

**Figure 3.** Effect of temperature (100 °C and 130 °C) and different concentrations of  $\text{SO}_4^{2-}$  ions (0–4 times the concentration present in synthetic seawater (SSW-US, SSW-1/2S, SSW, SSWx2S, and SSWx4S)) on oil recovery from a chalk core (AN = 2.07 mg KOH/g) from [123]. Reproduced with permission from Zhang et al., *Colloids Surf. A*; published by Elsevier, 2006.

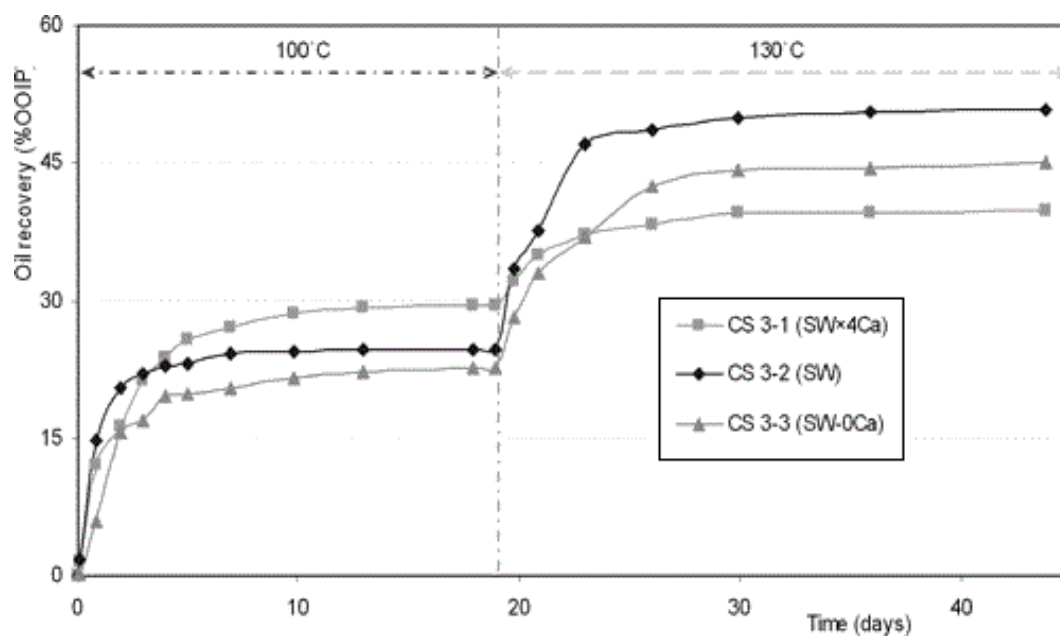

**Figure 4.** Effect of temperature (100 °C and 130 °C) and different concentrations of  $\text{Ca}^{2+}$  ions (0–4 times the concentration present in seawater (SW-0Ca, SW, and SWx4Ca), but constant amount of  $\text{SO}_4^{2-}$  ions) on oil recovery from a chalk core (AN = 2.07 mg KOH/g) from [111]. Reproduced with permission from Zhang et al., *Energy Fuels*; published by American Chemical Society, 2006.

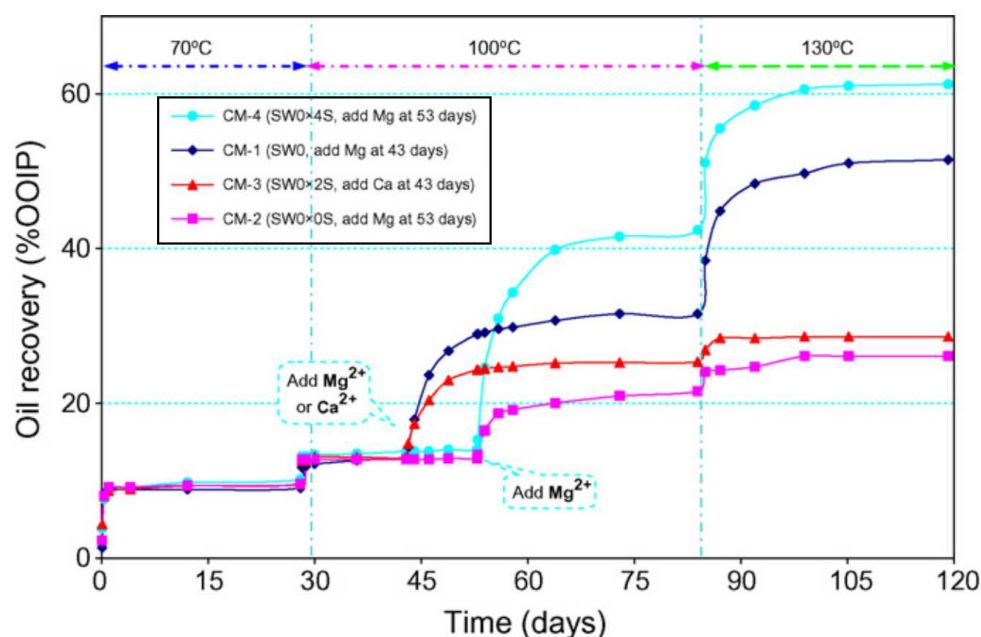

**Figure 5.** Effect of temperature (70 °C, 100 °C, and 130 °C) and PDIs ( $\text{Ca}^{2+}$ ,  $\text{Mg}^{2+}$  and  $\text{SO}_4^{2-}$ ) on oil recovery from a chalk core when modified seawater depleted in  $\text{Ca}^{2+}$ ,  $\text{Mg}^{2+}$  ions and different concentrations of  $\text{SO}_4^{2-}$  ions was used as initial imbibing fluids (SW0x0S, SW0x2S, SW0, and SS0x4S) and  $\text{Ca}^{2+}$ ,  $\text{Mg}^{2+}$  ions were added later as the same concentration present in seawater (AN = 2.07 mg KOH/g) from [63]. Reproduced with permission from Zhang et al., *Colloids Surf. A*; published by Elsevier, 2007.

As for the effect of non-active salt (NaCl), Fathi and co-workers suggested that the depletion of NaCl from seawater, as well as the presence of reactive ions ( $\text{Ca}^{2+}$ ,  $\text{Mg}^{2+}$  and  $\text{SO}_4^{2-}$ ), at elevated temperature (120 °C), are essential for wettability alteration of chalk surfaces and improved oil recovery [65,79,129]. They observed improvement in oil recovery by using NaCl depleted seawater and increasing  $\text{SO}_4^{2-}$  concentration up to four-times at 90 °C and a decrease in oil recovery, by increasing the concentration of NaCl in seawater up to four times at 100 °C (Figure 6). Similarly, improvement in oil recovery and water-wetness were observed by using NaCl depleted seawater containing four times the  $\text{SO}_4^{2-}$  concentration compared to seawater in a carbonate reservoir chalk cores [36]. However, it should be mentioned that, by virtue of removing NaCl from seawater, the total salinity is greatly reduced due to high concentration of this salt present in seawater. Therefore, it is expected that brine becomes more efficient and there is a possibility that NaCl is not a determinant salt in the brine.

Influence of polyatomic anions, e.g., borate ( $\text{BO}_3^{3-}$ ) and phosphate ( $\text{PO}_4^{3-}$ ), on the wettability alteration and improved oil recovery of limestone and dolomite cores free of anhydrite was examined, and it was found that they could facilitate 15–20% of OOIP additional oil recovery [27]. It is likely that considerable amounts of oil can be recovered when  $\text{SO}_4^{2-}$  ions are replaced by  $\text{BO}_3^{3-}$  and  $\text{PO}_4^{3-}$  ions in the injected brine when soft water ( $\text{Ca}^{2+}$  and  $\text{Mg}^{2+}$  depleted formation water) was used. Additionally, Meng and co-workers [130] showed that the presence of large amount of  $\text{PO}_4^{3-}$  ions (1000 mg/L) in seawater can alter wettability of limestone cores to a more water-wet condition at 90 °C. Similarly, it was suggested that  $\text{BO}_3^{3-}$  ions can substitute and replace  $\text{SO}_4^{2-}$  ions on chalk surfaces, but degree of substitution is limited at field scale due to formation of precipitate and aqueous speciation at reservoir pH [131]. It can be concluded, based on the previous studies, that the injection brine for LSW in carbonates should contain PDIs ( $\text{Ca}^{2+}$  and/or  $\text{Mg}^{2+}$ ,  $\text{SO}_4^{2-}$ ), depleted in NaCl, and operate at high temperatures (beyond 70 °C). However, there is a limit for increasing the concentration of  $\text{SO}_4^{2-}$  with increasing temperature, as high concentrations of  $\text{SO}_4^{2-}$  at high temperature results in precipitation of  $\text{CaSO}_4$  and reduces oil recovery. As for limestone cores containing anhydrite, the  $\text{SO}_4^{2-}$



ions generated due to dissolution of  $\text{CaSO}_4$  can give rise to oil recovery, which is dependant on the brine salinity/content and temperature. The solubility of  $\text{CaSO}_4$  increases as concentration of  $\text{Ca}^{2+}$  ions in the brine and temperature decreases, and concentration of  $\text{NaCl}$  increases [62]. In addition, concentration of  $\text{SO}_4^{2-}$  ions in the brine decreases as temperature increases, due to adsorption on the rock surface. On the other hand, the wettability modification process and oil recovery are improved by increasing temperature and decreasing concentration of  $\text{NaCl}$ . Therefore, the influence of non-active salt concentration and temperature contrast each other. Thus, for limestone, an optimum temperature for improved oil recovery in LSW is suggested to be in range of 90–110 °C [62].

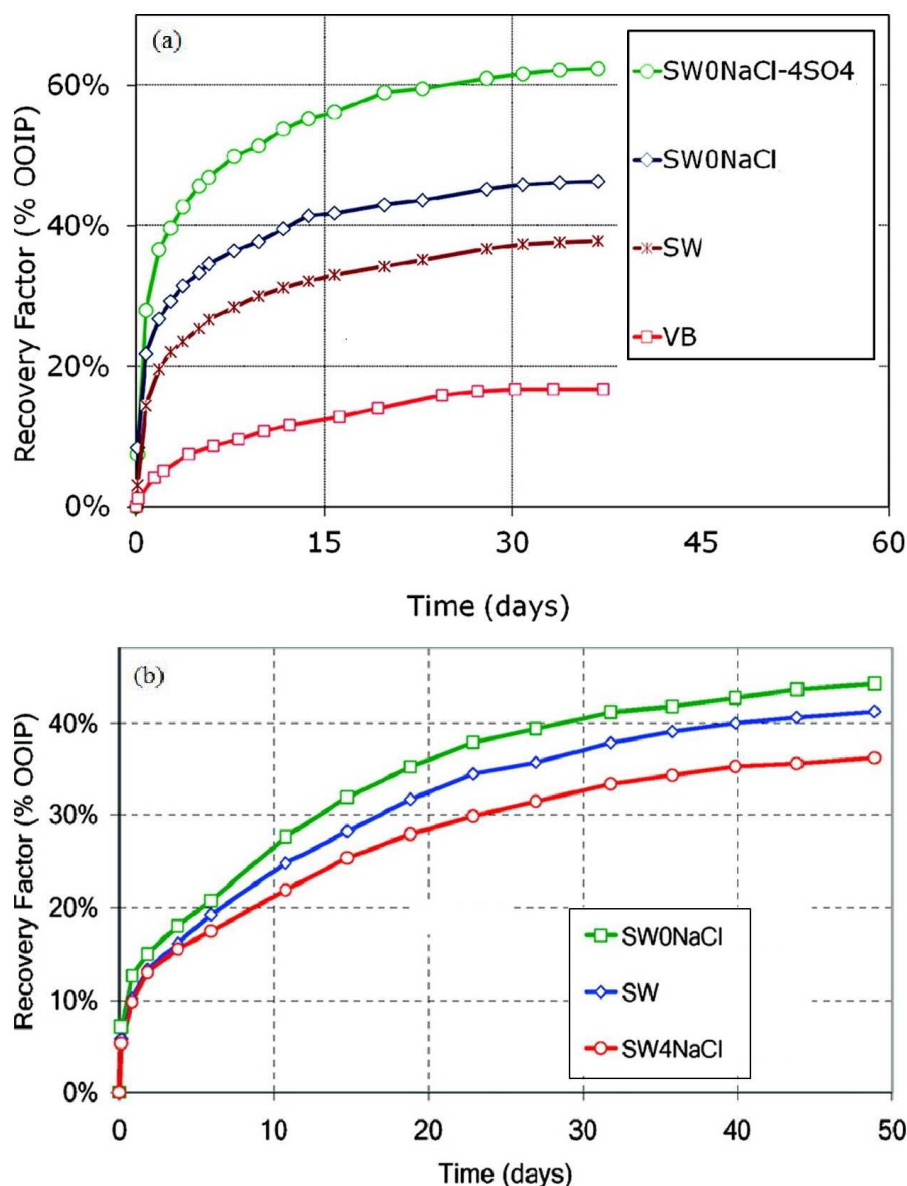

**Figure 6.** Oil recovery from a chalk core at (a) 90 °C (AN = 0.5 mg KOH/g) and (b) 100 °C (AN = 1.90 mg KOH/g) when formation water (VB), seawater (SW), NaCl depleted seawater (SW0NaCl), NaCl depleted seawater spiked with four times the concentration of  $\text{SO}_4^{2-}$  ions present in seawater (SW0NaCl-4SO4), and seawater spiked with four times the concentration of NaCl present in seawater (SW4NaCl), were used as imbibing fluids from [79] (reproduced with permission from Fathi et al., *Energy Fuels*; published by American Chemical Society, 2011) and [65] (reproduced with permission from Fathi et al., *Energy Fuels*; published by American Chemical Society, 2010).

### 2.2.2. Ionic Concentration

The effect of salinity on wettability alteration of carbonate rocks was studied using both diluted brine (formation water or seawater) and tuned brine. There are several experimental results reported in the literature that (up to 20-times) diluted seawater showed higher potential to improved oil recovery from carbonate reservoirs compared to the formation water and seawater [22,43,80]. For example, Yousef and co-workers [38,66,68] enhanced oil recovery from a carbonate reservoir (composite limestone cores) by using synthetic seawater (57,600 ppm) and up to 100-times diluted seawater. The highest levels of oil recovery were obtained using twice diluted seawater (28,800 ppm at 7–8.5% of OOIP) and 10 times diluted seawater (5760 ppm at 9–10% of OOIP). However, 20 times diluted seawater (2880 ppm) resulted in lower oil recovery improvement of 1–1.6% of OOIP and 100-times diluted seawater did not improve oil recovery. Therefore, the total additional oil recovery of approximately 18% was observed by using diluted seawater compared to the conventional waterflooding. Similarly, Sohal et al. [131] observed improvement in water-wetness of chalk by using up to 20-times diluted seawater, where higher dilution did not increase water-wet conditions. Effect of the formation water (160 kppm), seawater (32 kppm), and low salinity water (2 kppm) on oil recovery from limestone cores was studied by Tetteh et al. [81]. Their experimental results indicated 9.1% of OOIP incremental oil recovery by switching the injected brine from seawater to low salinity water. Moreover, Shehata and colleagues [127] observed a considerable improvement on oil recovery of limestone cores (50.4% of OOIP) by changing the concentration of injected brine from seawater in the secondary mode to deionized water in the tertiary mode, due to sudden changes in the injected brine ionic content between two recovery modes. However, it is worth noting that 20% diluted seawater did not improve oil recovery compared to seawater, while 50% diluted seawater showed a slight improvement. An improvement of 1–5% of OOIP with oil recovery in limestone cores that contain small amounts of anhydrite was reported in tertiary LSW, when diluting the high salinity formation brine (208,940 ppm) by 10 and 100 times [62]. Additionally, Zahid et al. [69] reported a significant improvement in oil recovery by using (up to 20-times) diluted synthetic seawater in reservoir carbonate (limestone) core plugs only at high temperature (90 °C). Furthermore, Alotaibi et al. [132] observed 8.6% of OOIP additional oil recovery using aquifer water (4 kppm) after the formation water (230 kppm) flooding. Similarly, it is shown that reducing the brine salinity (25-times diluted seawater) can improve rock water-wetness and increase oil recovery compared to seawater (44 kppm) and the formation water (180 kppm) flooding in reservoir limestone cores [133]. It was suggested that injection of seawater can also improve oil recovery in carbonates compared to conventional formation waterflooding, unlike sandstone reservoirs where only low salinity brine results in improved oil recovery.

The potential of enhanced oil recovery in carbonate cores at much higher concentrations than reported in literature was argued by Al-Harrasi et al. [134], based on 2, 5, 10 and 100 times diluted formation water, at 70 °C. They observed improved oil recovery even with high salinity twice diluted formation brine (9225 ppm), at 10% of OOIP, whilst the 100 times diluted formation brine (1944 ppm) resulted in maximum oil production and a faster oil production rate (up to 21% of OOIP). Additionally, Romanuka et al. [88] observed additional oil recovery from 4% to 20% of OOIP by lowering salinity of seawater (up to 10-times diluted) in limestone and dolomite core plugs. However, the highest oil recovery for chalk cores was found when using a higher concentration of  $\text{SO}_4^{2-}$  ions, rather than by reducing the ionic concentration. Furthermore, Al-Attar et al. [135] attempted to determine the optimum salinity of diluted seawater, where they observed improved oil recovery of 63–84.5% of OOIP from reservoir limestone, by varying the concentration of  $\text{Ca}^{2+}$  and  $\text{SO}_4^{2-}$  ions, which was attributed to intermediate wetting states. Their experimental results showed that increasing the concentration of  $\text{SO}_4^{2-}$  ions beyond 46.8 ppm has a negative effect on LSW processes. However, using 20-times diluted seawater (1600 ppm) resulted in a considerable decrease in oil recovery from chalk cores compared to seawater, from 60% to 15% of OOIP, due to a reduction in the amount of available PDIs [65]. It was suggested that wettability alteration is not a low salinity effect, and that seawater, up to a concentration of 33 kppm, can modify the wettability of rocks and improve oil recovery in LSW in carbonate [54,60,65].

Therefore, inconsistencies in the literature regarding the optimum concentration of the injected brine are reported. Even though low salinity brine has shown to improve oil recovery in most cases, and it is suggested that diluted brine without high quantities of PDIs can improve oil recovery from carbonates at elevated temperature [25]. It is also argued that reducing ionic concentration does not necessarily improve oil recovery and concentration of PDIs is claimed to play a more important role [60,65].

### 2.2.3. Surfactant

Wettability of carbonate surfaces can be altered toward a more water-wet state in the presence of surface active cationic surfactants dissolved in seawater, which help to enhance efficiency of LSW. Fourteen different types of surfactants were investigated to analyze the effect of surfactant on wettability alteration of oil-wet chalk cores [102]. The results suggested that cationic surfactants, of the type of alkyl trimethyl ammonium ( $R-N^+(CH_3)_3$ ), were able to desorb and release carboxylic material from the chalk surface in an irreversible way, and consequently improve oil recovery by up to 70% of OOIP. It was also found that anionic surfactants were not able to desorb anionic organic carboxylic molecules or modify the wettability irreversibly. The mechanism for wettability modification, in this case, was proposed as ion-pair formation between the cationic surfactants and the negatively charged carboxylic layer adsorbed on the carbonate, which results in formation of cationic–anionic complexes, releasing carboxylates from the rock surface. In a separate study, the effects of a non-ionic surfactant (ethoxylated alcohol, EA) and a cationic surfactant (dodecyltrimethylammonium bromide, DTAB) on wettability alteration of oil-wet carbonate reservoir cores were examined [136]. The experimental results showed that DTAB was more efficient than EA in wettability alteration towards a more water-wet condition, by recovering 45% and 10% of OOIP, respectively. Hognesen et al. [125] suggested that the activity of  $SO_4^{2-}$  as a PDI and wettability modifier of chalk surfaces increases as temperature is increased, by addition of cationic surfactant (DTAB) to the studied brine. Furthermore, Jarrahan et al. [137] studied the effect of a cationic surfactant (DTAB), nonionic surfactant (Triton X-100), and anionic surfactant (SDS) on wettability alteration of dolomite surfaces using various analytical techniques. Their results indicated that DTAB is most efficient in wettability alteration of dolomite surfaces to a more water-wet condition. In addition, Triton X-100 and SDS changed the wettability to weak water-wet and neutral wet conditions, respectively. Lastly, it was shown that  $Mg^{2+}$  ions in the presence of a cationic surfactant (DTAB) are able to remove adsorbed carboxylic material from calcite surfaces and led to a more water-wet surface compared to the absence of this surfactant [49].

## 3. Investigation Techniques

### 3.1. Surface Wettability

In an oil reservoir, wettability describes to what degree oil or water have the tendency to spread over the rock surface. In other words, wettability is a measure of the affinity of a surface towards one contacting fluid over another immiscible fluid, which is also present in the bulk. Wettability is an essential factor in a multiphase flow and fluid distribution in reservoir rocks. It also affects the relative permeability of a rock–fluid system [36]. Electrostatic attraction between carbonate rock–brine and oil–brine interfaces facilitate the formation of a thin and unstable water film and brings oil in contact with the carbonate mineral surface, which consequently traps hydrocarbons in the reservoir rock pores and reduces the oil recovery efficiency [138]. In this section, we review different techniques to infer surface wettability of carbonate rocks, such as chromatographic wettability test, contact angle measurements, diffusion nuclear magnetic resonance (NMR), atomic force microscopy (AFM), zeta potential measurements, and surface complexation modelling, and present the findings from such measurements.

#### 3.1.1. Chromatographic Wettability

The chromatographic wettability test is a technique developed by Strand et al. [124], based on the chromatographic separation of two water soluble compounds, such as non-adsorbing tracer ( $SCN^-$ ),

and a PDI ( $\text{SO}_4^{2-}$ ), toward a carbonate surface. The aim is to validate the alteration in a water-wet fraction after exposing carbonate rock samples to various fluids (water or oil). The area between the relative concentration of  $\text{SCN}^-$  and  $\text{SO}_4^{2-}$ , as a function of the injected pore-volume for a chalk core at residual oil saturation, can then be related to the water-wet area of the core. However, the chromatographic separation is only suitable for coreflooding in  $\text{SO}_4^{2-}$  free carbonate cores at low temperature [131]. Core preparation and aging for the chromatographic test includes two different procedures, depending whether the initial water is present or not. The cores are placed in a container and aged with either crude oil (without the initial water) or brine (with the initial water saturation) and the porosity is calculated using the weight difference, oil density, and bulk volume. The cores are then prepared using the Hassler core holder and flooded with the crude oil with pressure of 25 bar and then aged with the crude oil in a closed container to establish initial reservoir conditions [124].

The chromatographic test was used to determine the influence of different PDIs and temperature on wettability alteration of chalk and limestone cores [36,58,59,65,124,129]. For example, Strand et al. [124] examined the effect of  $\text{SO}_4^{2-}$  ions on wettability alteration of chalk cores using crude oil samples with different AN and synthetic brines, based on the chromatographic wettability test. They compared the results with those obtained from Amott–Harvey spontaneous imbibition tests at room temperature, and concluded that the chromatographic wettability test could be an appropriate tool to be used in the neutral-wet state and at residual oil saturation without performing long-term imbibition tests. With the same methodology, they carried on to measure the adsorption of  $\text{SO}_4^{2-}$  ions on chalk cores as a function of  $\text{Ca}^{2+}$  concentrations and temperatures [58]. The results showed that adsorption of  $\text{SO}_4^{2-}$  ions increases with increasing temperature and concentration of  $\text{Ca}^{2+}$  ions, which is consistent with their imbibition and zeta potential measurement results. Fathi et al. [65] studied the effect of salinity and the presence of  $\text{Ca}^{2+}$ ,  $\text{Mg}^{2+}$ , and  $\text{SO}_4^{2-}$  ions on wettability alteration of chalk surfaces and displacement of adsorbed carboxylic acid, at a range of temperatures (100–120 °C), where the order of improved water-wet fraction from diluted seawater, seawater and NaCl depleted seawater was confirmed by separate chromatographic wettability tests. Lastly, wettability of reservoir limestone cores and their reactivity toward PDIs ( $\text{Ca}^{2+}$ ,  $\text{Mg}^{2+}$ , and  $\text{SO}_4^{2-}$ ) in the temperature range of 20–130 °C was studied using the chromatographic test [59]. The experimental results indicated that the chromatographic wettability test is also applicable to limestone, where the PDIs interacted with the limestone surface and relative concentration of the PDIs affected the established chemical equilibrium. Additionally,  $\text{Ca}^{2+}$  and  $\text{Mg}^{2+}$  ions showed similar adsorption from a NaCl solution on the limestone surface at room temperature. However, by increasing temperature,  $\text{Mg}^{2+}$  ions adsorbed more strongly on the rock surface and at 130 °C,  $\text{Ca}^{2+}$  ions replaced  $\text{Mg}^{2+}$  ions on the rock surface. Moreover, interactions between  $\text{Ca}^{2+}$  and  $\text{Mg}^{2+}$  ions towards limestone surface in seawater was controlled by  $\text{SO}_4^{2-}$  ions and  $\text{Ca}^{2+}$  ions showed higher affinity to adsorb on the rock surface than  $\text{Mg}^{2+}$  ions, due to formation of ion-pair between  $\text{Mg}^{2+}$  and  $\text{SO}_4^{2-}$  ions and strong adsorption of  $\text{SO}_4^{2-}$  ions on the limestone surface.

### 3.1.2. Contact Angle

A contact angle measurement can quantitatively reflect the degree of wetting when a solid and two liquids are in contact, and is described as the angle between the solid and the liquid–liquid interface through the denser liquid phase [139]. Contact angle values show the equilibrium between the interfacial tensions of the two fluid phases and their adhesive attraction to the solid surface. The degree of liquid wettability increases when the contact angle of a liquid droplet on a solid surface decreases. In a system with reservoir rock, oil, and water, the rock could be: (i) water-wet when water is the spreading fluid (0° to 75°); (ii) intermediate/neutral-wet when the rock surface has no preference for either oil or water to spread on it (75° to 115°); and (iii) oil-wet when oil is the spreading fluid (115° to 180°). Additionally, weakly water-wet and weakly oil-wet are considered as 55° to 75°, and 115° to 135°, respectively [140]. However, contact angle measurement requires homogeneous surfaces without surface roughness. Therefore, a wide range of contact angle results are reported in the literature,

which is due difference in surface roughness of each carbonate rock type. The aging procedure for the contact angle test involves first surface alteration of carbonate surfaces with or without an initial brine solution, and then with a crude oil to establish an oil-wet state. Following the treatment with oil, the carbonate surfaces may be aged with a brine to study its influence on the wettability. Contact angle can be measured by a drop of water or a drop of oil. However, it is mostly an oil drop in a bulk of water, due to optical transparency of the system. [29].

Abdallah et al. [29] examined the effect of ionic composition ( $\text{Ca}^{2+}$ ,  $\text{Mg}^{2+}$ , and  $\text{SO}_4^{2-}$ ) and concentration of modified seawater, on wettability alteration of cleaved calcite (limestone) crystals aged with a crude oil using static contact angle measurements. They measured the contact angle of deionized water on calcite crystals after surface aging in crude oil and different brines. Their results show that first  $\text{SO}_4^{2-}$  ions and then diluted seawater have notable impacts on wettability alteration of calcite surfaces to strongly water-wet. Weaker wettability alteration was observed when removing  $\text{Mg}^{2+}$  ions from the brine, indicating that  $\text{Mg}^{2+}$  ions must be present in the brine. The effect of different smart brines on carbonate (limestone) rock wettability was measured by Awolayo et al. [78] using different synthetic brine solutions ( $\text{NaCl}$ ,  $\text{Na}_2\text{SO}_4$ ,  $\text{NaHCO}_3$ ,  $\text{MgCl}_2$ , and  $\text{CaCl}_2$ ), and an oil from a carbonate reservoir, on polished rock plates cut from the same carbonate reservoir core plugs aged with a synthetic brine and then the reservoir oil to restore their wettability toward reservoir conditions at 95 °C. Contact angle measurement of oil droplets on the submerged aged plates in the studied brines, confirmed that the contact angle decreases with increasing exposure time to brine and increasing  $\text{SO}_4^{2-}$  concentration, suggesting that rock wettability was modified from a strongly oil-wet to a weakly oil-wet condition. They explained that by increasing the concentration of  $\text{SO}_4^{2-}$  ions, the water film on the rock surface becomes thicker and more stable; therefore, the contact between oil droplets and rock surfaces is prevented, due to the repulsive electrostatic forces at the oil–rock interfaces. Thereby, wettability of the rock is altered and carboxylic acid is desorbed from the rock surfaces, whereafter  $\text{SO}_4^{2-}$  ions occupy the free sites on the rock surface. Hamouda et al. [141] studied the effect of temperature (25–80 °C) on wettability alteration of calcite (limestone) crystals previously aged with stearic acid, using advancing contact angle measurements. Their experimental results indicated that, as temperature increases, contact angle decreases and the wettability of calcite surface improves from strongly oil-wet, at low temperature ( $160 \pm 3^\circ$  at 25 °C), to a more water-wet condition at higher temperature ( $90 \pm 3^\circ$  at 80 °C). The influence of brine chemistry and temperature on wettability alteration of dolomite surfaces aged with crude oil was evaluated by water advancing contact angle [142]. The results showed that, by using up to 15 times diluted seawater, wettability of the dolomite surfaces were altered from an oil-wet condition ( $158^\circ$ ) to a neutral wet condition ( $86^\circ$ ). Additionally, similar wettability alteration behaviour was observed by increasing  $\text{SO}_4^{2-}$  concentration up to two times and increasing the temperature from 26 to 121 °C. Yousef et al. [68] measured contact angles of oil droplets on carbonate (limestone) rock plates submerged in brines of various salinity at reservoir conditions, and observed a reduction in contact angle from about  $90^\circ$  to  $60^\circ$  for formation water and 100 times diluted seawater, respectively. Lastly, oil-droplet contact angle of reservoir limestone and dolomite surfaces as a function of brine concentration and temperature (25–100 °C) was measured [25]. The experimental results indicated that by increasing temperature the rock surfaces became more water-wet, although the degree of water-wetness was dependant on the type of rock. For example, limestone showed less response to increasing temperature by reducing the brine salinity, while wettability of dolomite surfaces improved considerably at elevated temperature when using low salinity brine, which consequently can result in additional oil recovery.

### 3.1.3. Nuclear Magnetic Resonance (NMR)

Nuclear magnetic resonance (NMR) has been used as a rapid, non-destructive, and non-invasive methodology for both laboratory and field applications. A novel bench-type NMR instrument is designed, where T2 relaxation rate of proton nuclear spins in fluid samples in a porous rock is measured and has been used to determine the petrophysical properties of reservoir rock, such as



pore-size distribution, porosity, permeability, and rock wettability [68]. Yousef et al. [68] performed NMR T2 measurements on reservoir carbonate (limestone) rock samples used in their coreflooding study, before and after LSW treatment with a core water saturation ( $S_w$ ) of 1 to determine the effect of brine salinity on pore geometry and reactivity of the formation water on carbonate rock surfaces. Their experimental results showed that injection of various diluted seawater in the carbonate core samples can have a significant impact on surface relaxation alteration of carbonate surfaces. Surface relaxivity is a geochemical property that explains the capacity of the grain surface to improve relaxation and is usually increased as the concentration of paramagnetic ions on the rock surface increases [68]. In addition, an improvement in connectivity among macro and micro pores was observed, which was attributed to the rock dissolution, due to alteration in the brine composition. To investigate the effect of post core cleaning (with toluene and methanol) on the measured T2, they performed another NMR measurements on new cores before and after the cleaning process. The results indicated that the cleaning process had a negligible effect on the NMR T2 distributions and confirmed that modification of the brine content is indeed the cause of the observed shift in the position of T2 distribution between NMR results taken before and after LSW. However, NMR T2 distribution, performed by Zahid et al. [69], using different diluted synthetic seawaters showed no significant changes in surface relaxation and shift in T2 distribution of both reservoir carbonate (limestone) and outcrop chalk cores.

#### 3.1.4. Atomic Force Microscopy

The DLVO (Derjaguin, Landau, Verwey and Overbeek) theory is a classic mechanism explaining long-range interaction forces between the surfaces of two electrically charged particles in aqueous solution, based on London-dispersion (van der Waals) and electrostatic forces. Additionally, other contributions to the interfacial forces include hydrophobic, hydration, and steric forces, as well as hydrodynamic effects, which are known as non-DLVO (extended DLVO) forces [55,143,144]. All of these interfacial forces could contribute to the disjoining pressure of the water film which dictates its thickness. Generally speaking, attractive forces will have a negative contribution on the disjoining pressure and reduce the stability and thickness of the water film, whilst repulsive forces have a positive contributing to the disjoining pressure and produce more stable and thicker films, and a more water-wet rock surface [99]. The van der Waals forces between oil and carbonate surfaces are attractive, while the electrostatic force could be attractive or repulsive, based on the oil, brine and mineral compositions, as well as pH [99]. By reducing the ionic concentration, the electrostatic repulsive force increases and the EDLs at the oil–brine and rock–brine interfaces expand to become more diffuse (due to reduced ion density in the diffuse layer and increase of Debye screening length), and electrostatic screening becomes weaker, which causes the disjoining pressure to be more positive and prevents crude oil components from adhering to the rock surface and reduce adhesion force at rock–oil interfaces [25,26,42,145]. (However, this might not be always the case, as reducing brine salinity did not result in increased repulsion force for dolomite surfaces at lower temperature [25]). In contrast, by increasing the salinity, the magnitude of the electrostatic forces will be reduced and, at a certain concentration, the van der Waals attractive forces will overwhelm the repulsive electrostatic force and the water film will collapse, and consequently, the oil phase replaces the water phase and adheres to the rock surface [42,145]. In other words, a water film will remain stable if it can resist the pressure from the oil phase [85]. Therefore, rock surface wettability is dependent on the variation between the oil and water pressure (capillary pressure). Additionally, brines with lower ionic strength tend to reduce adhesion of the crude oil molecules on the rock surface by producing thicker water films and modifying rock wettability toward a more water-wet condition, thereby improving oil recovery.

Atomic force microscopy (AFM) can be used to directly measure adhesion forces, a combination of electrostatic and van der Waals forces, as well as forces, due to chemical bonds or acid–base interactions found in different fluids by generating force versus distance curves (force curves) [143]. Force curves provide valuable information about the solid properties, such as hardness, elasticity, surface energy

and surface charge densities [143]. The adhesive force between two surfaces can be affected by the properties of the material (surface roughness and inhomogeneity), as well as contact geometry [143]. To generate surface topography or force curves, the surface of the sample is scanned by a tip mounted on a fine cantilever. Micro-fabricated silicon nitride (tips) are commonly used, as they provide high resolution of surface force measurements; however, they introduce a further complication when determining the surface geometry at the nanometre scale and in the presence of complex surface chemistry [146]. This challenge can be addressed by attachment of a smooth sphere, of micrometre size (2–10  $\mu\text{m}$ ), to the cantilever tip (colloidal probe), thereby considerably reducing the issues related to sample roughness, since the sample surface needs to be smooth only at a similar scale to the radius of the curvature at the end of the tip (5–50 nm) [146].

Most previous AFM force measurement studies [147–154] in aqueous electrolyte solutions have used mica or silica substrates, due to their fine surface roughness, as well as providing a good basis for comparison, due to several other investigations, undertaken on these samples using other techniques. Limited work has been done in examining the wettability alteration of carbonate rock surfaces (calcite and dolomite crystals), following the adsorption of polar components of crude oil, using AFM force measurements. Undertaking AFM force measurements on calcite or dolomite crystals can be challenging, again, due to the surface roughness of these substrates and their heterogeneous surfaces. Karoussi and co-workers [155] studied the surface characteristics of polished and cleaved calcite substrates coated with organic long chain or short chain carboxylic acids (stearic and heptanoic acids) that were exposed to solutions of different pH. Both surface topography and adhesion were acquired. Their investigation showed that cleaved calcite samples are more suitable for AFM measurement than polished calcite, due to the surface roughness of polished samples. Due to the coating, there was a thin layer of alkane present on the calcite surface, which prevented spontaneous recrystallization of the surface. Force measurements showed the adhesion forces of heptanoic acid treated samples was not responsive to the pH of the environment. However, cleaved calcite, treated with stearic acid, showed higher adhesion forces at pH 5 than pH 10. In a recent study [156], growth and dissolution of a stearic acid coated calcite crystal that was exposed to various aqueous salt solutions were investigated using amplitude-modulation atomic force microscope. It was believed that stearic acid particles tend to act as “pinning points” on the calcite crystal, interfering with the growth and dissolution process. When supersaturated brine was used, the growth of crystal around dense stearic acid patches was observed, including the patches into the crystal accompanied by ionic impurities present in the solution. When the brine was diluted, the freshly grown material was dissolved and the stearic acid patches, formerly incorporated into the crystal during the growth phase, were exposed. Sauerer et al. [48] measured the surface free energy of calcite and dolomite samples using AFM adhesion force measurements, in order to predict carbonate reservoir wettability. Adhesion forces, between the installed colloidal calcite and dolomite particles on the AFM tip (Figure 7) and the planar cleaved calcite and dolomite samples, both in air and in the presence of organic solvents (ethylene glycol, bromonaphthalene and heptane) were measured. Reduced adhesion forces were observed in the presence of polar and non-polar solvents compared to the same systems in air. This was attributed to the presence of adsorbed water layers at both the AFM tip and on the mineral substrates, due to humidity in the air environment. This experiment demonstrated the applicability of this approach for determination of surface total energies of mineral surfaces by AFM force measurement and, therefore, provided a valuable new tool for reservoir characterisation. Overall, AFM adhesion force measurements of carbonate surfaces has not been studied extensively, due to the challenges involved in determination of surface roughness, heterogeneity, tip characterisation, as well as approach/retract conditions. However, the methodology has a great potential as a high-throughput approach to quantitatively evaluate the surface energy of natural objects such as carbonate formation.

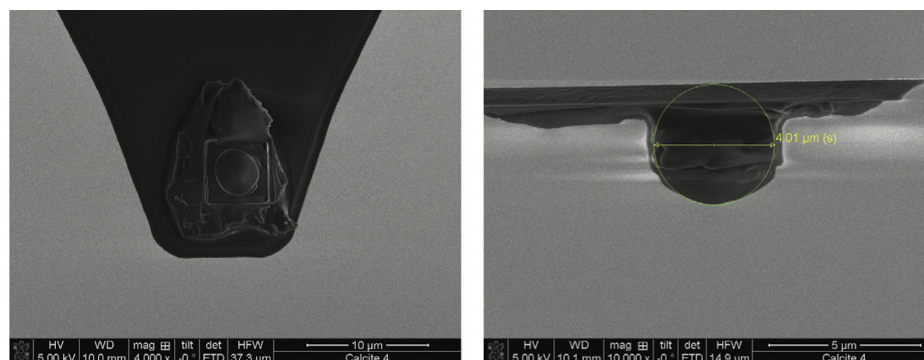

**Figure 7.** Scanning electron microscopy image of calcite particle fixed on a cantilever (calcite probe) used for force measurements from [48]. Reproduced with permission from Sauerer et al., *J. Colloid Interface Sci.*; published by Elsevier, 2016.

### 3.1.5. Zeta Potential

The surface charge of rock–brine or oil–brine interfaces is critical for better understanding the stability of water films and, therefore, the degree of rock wettability. Wettability of a rock is a function of the sign and magnitude of the electric surface charges at the two interfaces, which arises from the electrostatic interactions at the oil–rock–brine interfaces. Zeta potential is an essential parameter used to evaluate the electrokinetic behaviour of solid–liquid or liquid–liquid interfaces. Zeta potential indicates the electrokinetic properties of a particle, while the magnitude shows the stability of the colloidal system. Expansion of the EDL at the rock–brine and oil–brine interfaces will result in increased electrostatic repulsion between the two interfaces and consequently form a thick and stable film and a more water-wet rock surface. On the contrary, a thin and unstable water film could reduce the thickness of the EDL, resulting in the rock surface being more oil-wet. Additionally, the sign and magnitude of the zeta potential at rock–brine interfaces is dependent on the type and concentration of ions, pH, temperature, the presence of additives, such as surfactants, in the solution, as well as rock mineralogy [26]. However, zeta potential measurements require uniformly sized particles. Also, there are difficulties in measuring zeta potential of particles at high salinity, temperature, and pressure.

Previous zeta potential measurements have primarily focused on calcite surfaces as a representative of carbonate rock reservoirs [58,63,111,123,157–161], with considerable work using zeta potentials measured as a function of pH. The zeta potential measurements of carbonate surfaces are routinely inconsistent in both trend and magnitude, which could be attributed to the specific systems examined, such as sources of calcite. In addition, the complex dissolution mechanism of calcite in water makes it difficult to reach equilibrium in solution. The zeta potential of calcite is mostly measured at high pH (above 7) to prevent dissolution of the mineral. Carbonate surfaces are aged with carboxylic acid materials using two methods: dry and wet aging [137,157,162]. In the dry method, carbonate surfaces are immersed into dry carboxylic acid materials or carboxylic acid material dissolved in an oil phase (e.g., *n*-heptane, *n*-decane, toluene), while, in the wet method, the carbonate surfaces are aged with carboxylic material in the presence of water film, where carbonate surfaces are added to deionized water (in the presence or absence of electrolytes) and then carboxylic acid materials dissolved in an oil phase are added to the system. The suspensions in both methods are shaken for a period of time to ensure adsorption of fatty acid molecules on the rock surface and then the aged powder is dried.

Zeta potential of calcite particles was measured as a function of concentration of monovalent ( $\text{Na}^+$ ) and multivalent ( $\text{Ca}^{2+}$ ,  $\text{Ba}^{2+}$  and  $\text{La}^{3+}$ ) ions, over a range of pH [163]. It was suggested that  $\text{Na}^+$  act as indifferent ions towards calcite surfaces, whilst  $\text{Ba}^{2+}$  showed similar behaviour to that of  $\text{Ca}^{2+}$ , increasing the positive magnitude of calcite zeta potential with increasing concentration. However, the presence of  $\text{Ba}^{2+}$  ions resulted in a greater magnitude of zeta potential compared to  $\text{Ca}^{2+}$ , due to

the higher hydration energy of  $\text{Ca}^{2+}$  ions. However,  $\text{La}^{3+}$  ions showed an opposite behaviour to that of the divalent cations, resulting in reduced zeta potential values with increasing ionic strength, due to the lacking of specific adsorption on the calcite surfaces. The effects of concentration of two types of divalent ions, namely  $\text{Ca}^{2+}$  and  $\text{SO}_4^{2-}$ , were investigated for their impact on surface charge of milled chalk in NaCl brine [58]. It was suggested that surface charge of chalk surfaces is controlled by the relative concentration of  $\text{Ca}^{2+}$  and  $\text{SO}_4^{2-}$  and the chemical mechanism for surface charge modification was proposed as adsorption of  $\text{SO}_4^{2-}$  ions, in parallel with the co-adsorption of  $\text{Ca}^{2+}$ , with increasing temperature on the conditioned chalk surface. Similarly, the effect of PDIs ( $\text{Ca}^{2+}$ ,  $\text{Mg}^{2+}$ , and  $\text{SO}_4^{2-}$ ) on surface charge and wetting properties of chalk was studied by Zhang et al. [63,111,123] using zeta potential measurements. It was suggested that  $\text{Mg}^{2+}$  ions can substitute  $\text{Ca}^{2+}$  ions from chalk surfaces at high temperature, and increase the positive surface charge density.

Mahani et al. [25,26,164] suggested that surface charge alteration is likely to be the main mechanism for LSW in carbonates, where they examined calcite, limestone, chalk and dolomite surfaces. They observed that, regardless of carbonate rock type, zeta potential is positive for the high salinity formation water (180 kppm) at pH 6.5–8.5, while diluted seawater (1750 ppm) and addition of  $\text{SO}_4^{2-}$  ions lead to more negative surface charges and more water-wet conditions. Changes in pH influenced the zeta potential at low concentrations of brine, due to the presence of fewer active ions compared to  $\text{H}^+$  and  $\text{OH}^-$  ions. Additionally, when being exposed to diluted seawater, surface charge of carbonate (limestone) rock particles was found to become more negative, resulting in greater interactions with water molecules and rock wettability alteration [37,67].

Zeta potential measurements of rock–brine and oil–brine interfaces in the temperature range of 25–70 °C showed that, by increasing temperature, the observed trend as a function of salinity and pH remains the same for all rock types, although the magnitude of zeta potential changes [25]. As temperature increased, the magnitude of zeta potential of both rock–brine and oil–brine interfaces reduces towards the point of zero potential. This reduction in magnitude of zeta potential was more apparent for low salinity brine, which could be due to lower concentration of  $\text{SO}_4^{2-}$  ions, allowing  $\text{Ca}^{2+}$  and  $\text{Mg}^{2+}$  ions to adsorb on the rock surfaces [25]. Additionally, zeta potential measurements of calcite at elevated temperatures and pressures showed that the negative magnitude of zeta potential increases with increasing temperature and pressure, up to 45 psi, before decreasing at higher pressures, due to changes in solubility of minerals, which affects the EDL structure and consequently surface charges [165].

As for the effect of adsorbed carboxylic acid materials on surface charge modification of carbonates, Gomari and co-workers [157,158] observed that zeta potential surface charge of calcite was altered from positive to negative, in the presence of stearic and oleic acids (introduced onto the calcite particle using both dry and wet treatments). The ability for  $\text{SO}_4^{2-}$  and  $\text{Mg}^{2+}$  ions to displace the pre-adsorbed carboxylic acid materials from the calcite surface was suggested, based on zeta potential measurements. It was reasoned that ions causing positive carbonate surface charges are likely to change surface wettability of limestone and dolomite surfaces toward a more oil-wet condition, whereas negatively charged minerals increase oil recovery by releasing trapped crude oil molecules [159,166]. The effect of a mixture of ions ( $\text{Ca}^{2+}$ ,  $\text{Mg}^{2+}$ , and  $\text{SO}_4^{2-}$ ) on zeta potential of calcite and dolomite surfaces aged with stearic acid (using the dry method) was investigated by Kasha et al. [30]. The results confirmed that, as the concentration of divalent  $\text{Ca}^{2+}$  and  $\text{Mg}^{2+}$  ions increases, the zeta potential of the aged calcite was altered from negative to positive and resulted in higher positive charge in dolomite, while  $\text{SO}_4^{2-}$  ions caused the zeta potential of the carbonate surfaces to be more negative. Such a change in the measured zeta potential is highly likely, due to the affinity of  $\text{Ca}^{2+}$ ,  $\text{Mg}^{2+}$ , and  $\text{SO}_4^{2-}$  ions being affected by the presence of other PDIs when using mixtures of ions. Additionally, Jackson et al. [145] measured zeta potentials of rock–brine and oil–brine interfaces using a reservoir limestone core sample and various oil components to investigate the effect of different salts ( $\text{NaCl}$ ,  $\text{CaCl}_2$ ,  $\text{MgCl}_2$ , and  $\text{Na}_2\text{SO}_4$ ) on wettability alteration and oil recovery. It was suggested that in order to design an optimum brine composition for LSW in carbonates, zeta potential of both mineral-brine and oil-brine must be taken



into account. The authors reported positive surface charge for the oil-brine system for the first time. It was concluded that LSW results in oil recovery improvement only if two mineral-brine and oil-brine interfaces have the same sign of zeta potential (both positive or both negative), which results in repulsive electrostatic forces and positive contribution to disjoining pressure and acts to stabilize the water film on the mineral surface (Figure 8). Therefore, the studies that reported failure in improving oil recovery by performing LSW, may have had a positively charged oil-brine interface, which had not been identified [145]. Lastly, zeta potential of calcite and dolomite surfaces aged with stearic acid was studied using synthetic diluted seawater [31]. The examined calcite surfaces maintained negative zeta potential in the presence of deionized water and in the all tested brines, excluding diluted seawater with higher concentration of cations ( $\text{Ca}^{2+}$  and  $\text{Mg}^{2+}$ ), which resulted in a positive zeta potential. In contrast, dolomite surfaces showed positive zeta potential in deionized water and the diluted brines, except for diluted seawater containing two and four times higher concentrations of  $\text{SO}_4^{2-}$ . It was concluded that diluted seawater is less efficient in altering surface charge of dolomite, due to the tendency of stearic acid to adsorb more strongly on dolomite surfaces.

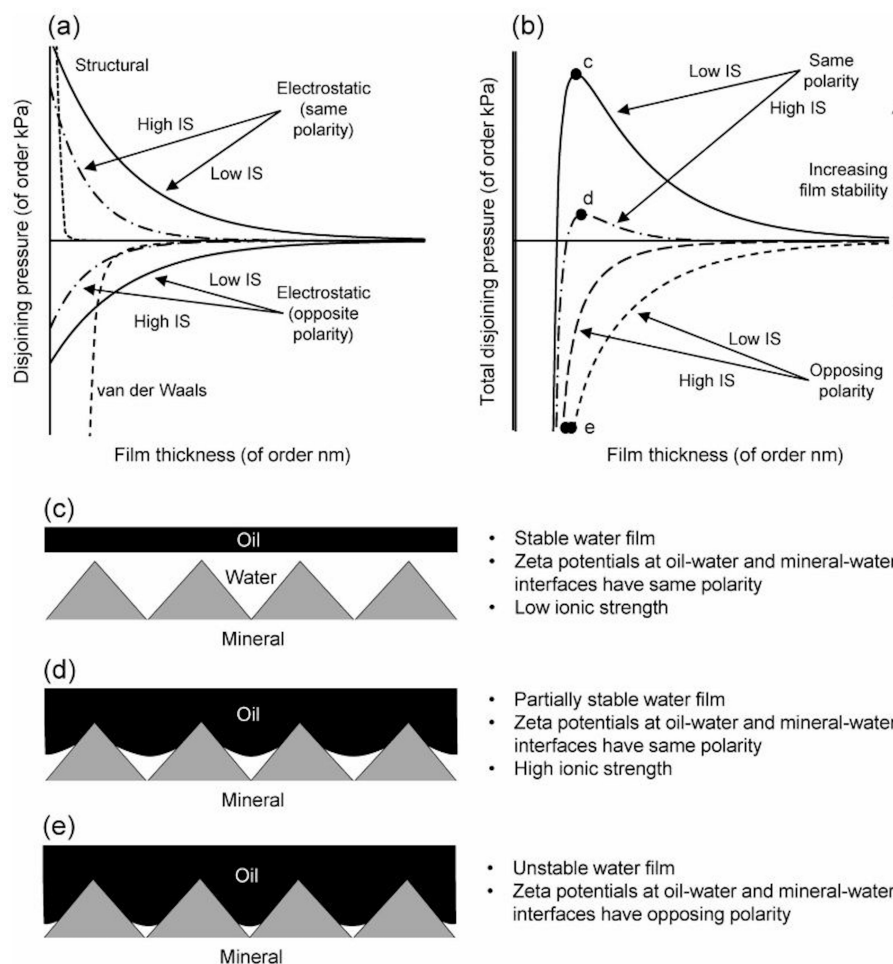

**Figure 8.** Effect of disjoining pressure on wettability alteration of carbonate surfaces: (a) schematic view of contribution of electrostatic and van der Waals forces on disjoining pressure; (b) total disjoining pressure at low and high ionic strength (IS) when rock-brine and oil-brine interfaces have the same/opposite sign of zeta potential; and (c–e) schematic models showing stability of water film between oil and mineral interfaces (water-wet, mixed-wet, and oil-wet conditions, respectively). Reproduced from reference [145].



### 3.1.6. Surface Complexation Modelling

A surface complexation model (SCM) simulates the chemical equilibrium, based on the chemical reactions occurring at the mineral-solution interfaces, which results in the formation of surface complexes. These surface complexes are responsible for the mineral surface charge and their equilibrium constants are assumed to be similar to the analogue reactions in the bulk solution [167]. The SCM is used to describe adsorption of inorganic ions on mineral surfaces using either inner or outer-sphere surface complexes and fit these models to adsorption data to distinguish between inner- and outer-sphere adsorption mechanisms [168]. The SCM has been used to understand surface charges of carbonate particles and calculate surface potential that can be validated by experimentally measured zeta potential values. Hiroth and co-workers [85,169,170] developed a geochemical model to investigate the effect of water chemistry on surface charge, considering mineral precipitation and dissolution of calcium carbonate rock, based on a calculation for formation water and seawater at 70–130 °C by determining the expected dissolved  $\text{Ca}^{2+}$  ions in the brine effluent after LSW against oil recovery from a outcrop core. It was suggested that the model could precisely predict the surface potential of calcite, and adsorption of  $\text{SO}_4^{2-}$  ions from pore water, and concluded that changes in surface potential cannot describe all aspects of oil recovery improvement by alteration of pore water chemistry and temperature. Instead, mineral dissolution could be the main mechanism.

A Basic–Stern surface complexation model, based on zeta potential results for calcite, considering outer-sphere complexes of ions other than protons and hydroxide, was developed by Heberling et al. [171]. It was suggested that the model can successfully predict zeta potential results with acceptable values for the inner Helmholtz capacitance, which is in agreement with the estimated Stern layer thickness, based on surface diffraction data. In another attempt, Mahani and colleagues [167] built a surface complexation model relating the surface reaction to their experimental zeta potential results for different types of carbonate rock, as a function of ionic concentration and pH. Their model confirmed that zeta potential increases with increasing pH, due to formation of surface species, which strongly affect the total surface charge. Additionally, at higher concentration, the surface charge of carbonates is less sensitive to changes in pH, resulting in a smaller variation in zeta potential. It was suggested that this particular model could capture the changes in the surface charge of carbonate rocks by altering salinity and pH. Lastly, Song et al. [172] used a double layer surface complexation to model experimental results obtained from synthetic calcite zeta potential measurements using mixed PDIs ( $\text{Ca}^{2+}$ ,  $\text{Mg}^{2+}$ ,  $\text{SO}_4^{2-}$ , and  $\text{CO}_3^{2-}$ ) and different  $\text{CO}_2$  partial pressures to systematically analyse the contribution of charged species, and better understand the role of electrostatic forces in wettability alteration of calcite. It is claimed that their model can precisely predict calcite zeta potential in brine containing PDIs and apply it to predict zeta potential at low and high pressures of  $\text{CO}_2$ .

### 3.2. Interfacial Tension

Distributions of fluid in the reservoir porous media are also dependant on the forces at liquid–liquid interfaces, which are quantified by interfacial tension (IFT) measurements. The effect of ionic content, as well as temperature and pressure on the IFT of crude oil–brine systems have been extensively studied. For example, the influence of NaCl concentration on the IFT of an oil phase (*n*-dodecane) and water was examined [173], where a critical salt concentration of NaCl (5 wt %) resulted in the lowest IFT. It was concluded that lowering the ionic concentration of brine will not always decrease the IFT. Moreover, Hamouda and Karoussi [155] measured IFT of stearic acid in an *n*-decane-water system including  $\text{MgCl}_2$  and  $\text{Na}_2\text{SO}_4$ , where they observed lower IFT in the presence of  $\text{Mg}^{2+}$  ions compared to  $\text{SO}_4^{2-}$  or distilled water by increasing temperature from 0–80 °C. In a different work, Meng and co-workers [130] examined the influence of  $\text{PO}_4^{3-}$  ions on the IFT and wettability alteration of carbonate reservoirs by increasing temperature from 25–90 °C, based on IFT and contact angle measurements. The brine with a higher concentration of  $\text{PO}_4^{3-}$  ions showed higher wettability alteration, as well as a reduction in the IFT compared to brine with a lower concentration

of  $\text{PO}_4^{3-}$ . This could be due to strong ability of these ions to desorb crude oil from pore throats and enhanced ionic exchange at both rock–fluid and fluid–fluid interfaces.

The effect of monovalent and divalent cations ( $\text{NaCl}$ ,  $\text{CaCl}_2$  and  $\text{MgCl}_2$ ) in range of concentration of 0–45 kppm on crude oil–brine interactions using an Iranian crude oil, as well as extracted asphaltene and resin from the crude oil was investigated using the IFT measurements [174]. The experimental results indicated that  $\text{NaCl}$  has a slight influence on IFT of asphaltene and resin, whereas the effect of  $\text{CaCl}_2$  and  $\text{MgCl}_2$  on the IFT was more apparent. At low concentration of the divalent salts, asphaltene resulted in a higher reduction in IFT compared to resin, while at higher salts concentration, the reduction in IFT was more dominant in case of resin. Additionally,  $\text{MgCl}_2$  resulted in higher reduction in IFT of resin than  $\text{CaCl}_2$ , due to the higher affinity of  $\text{Mg}^{2+}$  ions to bond with the oxygen molecules present in resin. In contrast,  $\text{Ca}^{2+}$  resulted in greater IFT reduction in asphaltene than  $\text{Mg}^{2+}$ . This could be due to a higher chance of forming of complexes between  $\text{Ca}^{2+}$  and asphaltene molecules because of their molecular sizes. It was concluded that oil–brine interactions are dependant on the presence of natural surface active compounds in crude oil (both asphaltene and resin), as well as type and concentration of ions in brine. Similarly, it was shown that IFT of crude oil–brine interfaces is dependant on asphaltene content of crude oil as a function of monovalent and divalent cation ( $\text{NaCl}$  and  $\text{MgCl}_2$ ) concentrations [175]. In a different work, the effect of different ions ( $\text{Ca}^{2+}$ ,  $\text{Mg}^{2+}$ ,  $\text{SO}_4^{2-}$ ), as well as diluted and softened seawater on dynamic IFT of crude oil–brine interfaces was studied [176]. The experimental results indicated that in all brines, IFT reduced over time (about 12 mN/m) until it reached a stable value depending on the type of brine. It was suggested that under dynamic conditions, active ions present in the brine can migrate to the surface until reaching equilibrium over time. Therefore, interfacial properties were claimed as an important contribution to the LSW mechanisms, which is affected by crude oil composition, type of ions, temperature, and contact time. However, brine composition was suggested to have a more significant effect on IFT than brine concentration.

The influence of brine salinity on the IFT of crude oil–brine was also studied by using diluted reservoir fluids [177], where a reduction in IFT (critical spreading tension) for up to 50% volume diluted reservoir brine was observed; however, further dilution of the brine increased the IFT. The authors suggested that a critical salinity of brine should be proposed to enhance oil recovery, based on IFT results. Similarly, Okasha et al. [178], investigated the effect of diluted brine on IFT of an oil–brine interface, where they observed a reduction in the IFT by decreasing the ionic concentration to twice and four-times diluted reservoir brine, using different crude oils under reservoir conditions, as well as reduction in IFT by increasing temperature and increase in IFT by increasing pressure. They suggested that, based on the IFT results, LSW may have a potential to improve oil recovery in carbonates. In contrast, Alameri et al. [179] observed an increase in the IFT of oil–brine by reducing the salinity of the brine from formation water to various diluted seawater and deionized water, which was attributed to reduction of pH of the brines. Additionally, the effect of diluted seawater on IFT of oil–brine interfaces was studied by Yousef et al. [38,68], when various diluted brines and crude oils at reservoir conditions were examined. The authors only observed reduction in IFT by diluting the fluid from formation water to seawater and no changes in IFT were observed by using different diluted seawater. It was concluded that LSW has no significant influence on the IFT and therefore fluid–fluid interactions. Lastly, dynamic IFT of crude oil–brine interfaces using a formation water, seawater and diluted seawater was studied [81]. The experimental results showed that the equilibrium IFT reduced significantly in the case of seawater, but not formation water and diluted seawater. Similar observations were reported in the literature where seawater resulted in the lower IFT compared to low salinity brine [38,68,174,180]. This was attributed to the presence of  $\text{SO}_4^{2-}$  ions in seawater and its effect to reduce dynamic IFT of seawater–crude oil interfaces [81]. Therefore, it was suggested that reduction of IFT and improvement of the capillary number could be a mechanism for seawater flooding but not LSW.

### 3.3. Recovery Factor

Recovery factor is reported as a percentage of the extracted crude oil that is initially in place, and it is affected by the displacement mechanism. The main purpose of EOR processes is to maximize the recovery factor. In this section, different techniques that have measured the recovery factor by performing LSW, such as imbibition, coreflooding, and reservoir modelling are summarized.

#### 3.3.1. Imbibition

Spontaneous imbibition is a process where a non-wetting phase is displaced by a wetting phase in a porous medium, due to capillary forces (combined effect of interfacial tension, wettability, and pore throat size). Therefore, it is a reliable laboratory technique that not only is used to determine the initial rock wettability conditions, but also the ability of different fluids to modify the wettability of rock surface towards a more water-wet state [22,181]. Wettability alteration of rock is quantitatively measured by the amount of brine being absorbed into or oil being displaced from the porous material. However, the spontaneous imbibition test is very time-consuming, as it takes months to collect results using this method. In addition, the chance of precipitation in the presence of reactive anions (e.g.,  $\text{SO}_4^{2-}$ ) is not taken into account in the spontaneous imbibition test [131].

A range of imbibition experiments on chalk [65,92,93,103,111,125] and reservoir limestone [59,125] were performed by Austad and co-workers to better understand the wettability alteration mechanism during LSW processes involving carbonates. Their findings for chalk cores were already discussed in previous sections. As for the limestone cores, the effect of  $\text{SO}_4^{2-}$  ions in the imbibing fluid was investigated, where synthetic seawater resulted in 15% OOIP additional oil recovery from a reservoir limestone core (aged with a crude oil (AN = 0.05 and BN = 0.44 mg KOH/g) for four weeks at 90 °C), compared to  $\text{SO}_4^{2-}$  depleted seawater at 120 °C [59]. Similarly, Ligthelm et al. [20] observed 5% improvement in oil recovery (total recovery of 17% OOIP) from a microcrystalline limestone core compared to the formation water by increasing concentration of  $\text{SO}_4^{2-}$  ions (up to 54 times) and reducing concentration of  $\text{Ca}^{2+}$  ions (about 22 times), to avoid critical solubility and precipitation limit of  $\text{CaSO}_4$ . However, Hognesen et al. [125] observed no improvement in oil recovery in spontaneous imbibition test on unfractured limestone cores (aged with a crude oil (AN = 1.7 mg KOH/g) for four weeks at 90 °C) by increasing  $\text{SO}_4^{2-}$  concentration to three times the concentration present in a synthetic seawater at 120 °C. Furthermore, Yi and Sarma [80] performed spontaneous imbibition on limestone core plugs from a carbonate reservoir (aged with a crude oil for three weeks) using diluted seawater, where they observed total oil recovery production of 23% of OOIP. Their results indicated that rock wettability is altered toward a more water-wet condition by LSW at 70 °C.

Imbibition measurements can be performed under various conditions. For example, Romanuka et al. [88] performed Amott spontaneous imbibition tests on samples collected from oil-bearing zones, namely outcrop chalks, limestone, and dolostone (aged with different crude oils (AN = 0.92 and BN = 0.16 mg KOH/g, AN = 0.42 and BN = 0.1 mg KOH/g, and AN = 0.07 and BN = 1.77 mg KOH/g) for four weeks at reservoir temperature), with increasing concentration of  $\text{SO}_4^{2-}$ . The tests were conducted under simulated reservoir conditions, by controlling key parameters, such as formation water and crude oil composition, as well as temperature. Their results showed increased oil recovery, from 4% to 20% of OOIP, in tertiary oil recovery mode, due to an improved water-wet condition. Kazankapov et al. [36] performed spontaneous imbibition tests on carbonate reservoir cores (aged with a crude oil (AN = 2.8 and BN = 0.74 mg KOH/g) for four weeks at 90 °C) acquired from the Caspian sea using NaCl depleted seawater, containing four times the  $\text{SO}_4^{2-}$  concentration at 90 °C, where they observed an improvement of 10% of OOIP in oil recovery compared to seawater. Lastly, Al Harrasi et al. [134] observed an increase in oil recovery, by 16–21% of OOIP, by performing spontaneous imbibition on carbonate reservoir core samples aged with a crude oil for 20–30 days, using synthetic diluted seawater at 70 °C. Even though spontaneous imbibition shows direct evidence of oil recovery and wettability alteration by LSW and indicates the efficiency of low salinity water as imbibing brines, it was argued that spontaneous imbibition results cannot be used directly to evaluate the potential

recovery of LSW on the field scale, especially for non-fractured reservoirs, as the recovery factor during LSW is less than that of spontaneous imbibition test. For this reason, coreflooding tests are used to quantify the effect of brine salinity and composition on incremental oil recovery during LSW.

### 3.3.2. Coreflooding

Coreflooding experiments are used to better understand the wettability mechanism of improved oil recovery by performing LSW. Most previous coreflooding studies on carbonate cores [22,27,43,80,179], were performed at low flooding rate condition (about 1 ft/day equal to  $0.3 \text{ cm}^3/\text{min}$ ), where up to 40% of OOIP additional oil recovery was reported, in comparison to conventional formation waterflooding. However, in this condition, capillary force is the dominant factor, with flow and oil production being strongly influenced by capillary end effects, which results in marginal overestimation of residual oil saturation and suppression of the water end point relative permeability [182]. Therefore, the reduction of capillary end effects, due to wettability alteration toward a more water-wet state in the LSW process, could have positive impacts on the improved oil recovery, which is not the case for real reservoir conditions, as there is no capillary end effect at field scale. This has to be taken into consideration when interpreting coreflooding results. For example, Gupta et al. [27] performed coreflooding experiments on limestone and dolomite cores (aged with a crude oil (AN = 0.11 mg KOH/g) for six weeks at reservoir temperature) with flooding rates of 1–2 ft/day ( $0.1 \text{ cm}^3/\text{min}$ ), where they observed 7–9% improvement in oil recovery in limestone cores by switching imbibing fluid from the formation water to seawater, 5–9% additional oil recovery in dolomite and non-fractured limestone cores by imbibing the core with seawater with added  $\text{SO}_4^{2-}$  ions, compared to the formation water, and 15% and 20% improvement in oil recovery by addition of  $\text{BO}_3^{3-}$  and  $\text{PO}_4^{3-}$  to synthetic seawater, respectively. Moreover, Nasralla and co-workers [22] performed quantitative and qualitative coreflood tests on reservoir limestone cores (aged with a crude oil for 28 days at reservoir temperature ( $100 \text{ }^\circ\text{C}$ )) intentionally at low flooding rates ( $0.25 \text{ cm}^3/\text{min}$  or  $0.05 \text{ cm}^3/\text{min}$ ) in order to examine capillary pressure. They observed up to 7% of OOIP improvement in oil recovery using 10-times diluted seawater and confirmed the higher potential of diluted seawater compared to seawater and the formation water to improve oil recovery in the secondary and tertiary modes.

To overcome capillary end effects, Al-Harrasi et al. [134] examined carbonate cores (aged with a crude oil for 20–30 days) at  $70 \text{ }^\circ\text{C}$  with higher injection rates ( $0.4$ ,  $0.7$  and  $1.3 \text{ cm}^3/\text{min}$ ) during high salinity waterflooding, before injecting low salinity brine, where an improvement of oil recovery from 3% to 5% of OOIP by using diluted formation water was observed. They reported low salinity effects within first pore-volume of the injected brine for such a high salinity for the first time. Additionally, Shehata et al. [127] used outcrop limestone cores (aged with a crude oil (AN = 0.18 and BN < 0.01 mg KOH/g) for 20 days at reservoir temperature ( $90 \text{ }^\circ\text{C}$ )) in their coreflooding experiments, operated at secondary and tertiary modes at  $90 \text{ }^\circ\text{C}$ , with injection rates of  $0.25$ ,  $0.5$ ,  $1.0$ , and  $2.0 \text{ cm}^3/\text{min}$  to avoid capillary end effects. The experimental results showed that deionized water and 50% diluted seawater improved oil recovery up to 3% of OOIP in the tertiary mode, compared to seawater in the secondary mode. Laboratory coreflooding experiments were performed using composite cores from a Saudi Arabian carbonate (limestone) reservoir (aged with a crude oil (AN = 0.25 mg KOH/g) for six weeks), and various diluted synthetic seawaters with injection rates of  $1$ ,  $2$  and  $4 \text{ cm}^3/\text{min}$ , reflecting reservoir conditions, such as temperature, pressure, and initial formation water [38,68]. The authors observed additional oil recovery, of up to 10% of OOIP, showing substantial potential of LSW to improve oil recovery from carbonates. Moreover, reductions in the pressure drop across the examined carbonate core and, consequently capillary forces by reducing the brine salinity was observed, which was attributed to modification of oil–rock–brine interactions. Lastly, limestone outcrop cores (aged with a crude oil (AN = 0.17 and BN = 0.11 mg KOH/g) for 40 days) were flooded with a synthetic formation water, seawater and diluted seawater with flooding rate of  $1\text{--}2 \text{ cm}^3/\text{min}$  [81]. The experimental results showed an additional 9.1% of OOIP improvement in oil recovery by LSW (2 kppm, 49.1%), compared to seawater flooding (33 kppm, 40%) in the tertiary mode. The coreflooding experiment was also performed using a non-aged limestone core to minimize

the effect of wettability alteration, where improvement in oil recovery by LSW was still observed (additional 3%), indicating that there might be another mechanism apart from wettability alteration involved in LSW. It was concluded that both wettability alteration and fluid–fluid interactions could be two potential mechanisms for improved oil recovery by LSW.

### 3.3.3. Reservoir Modelling

Reservoir modelling in carbonates includes consideration of the effect of LSW on wettability alteration by simulating capillary pressure and relative permeability, as a function of ionic concentration/composition or temperature. Such models have been developed using experimental spontaneous imbibition or coreflooding experimental results. Reservoir modelling is a very valuable tool, as it helps to verify and validate the experimental LSW results to predict wettability process at reservoir conditions (high temperature and pressure), where experimental work may not be possible. Yu et al. [183] developed a numerical model to simulate dynamic wettability of oil-wet chalk cores, taking into account molecular diffusion, adsorption of a wettability modifier agent ( $\text{SO}_4^{2-}$  ions), gravity, and capillary pressure. The correlation between capillary pressure and relative permeability and its influence on wettability alteration was calculated by interpolation. Their modelling results indicated that the adsorption of  $\text{SO}_4^{2-}$  ions onto the rock surface induced wettability alteration, thus modifying the dynamic capillary pressure curve to higher values from oil-wet to water-wet state. Additionally, it was shown that the capillary pressure depends on both initial water saturation and the  $\text{SO}_4^{2-}$  concentration, as it was altered from negative (at initial water saturation) to positive towards a more water-wet condition. The simulated capillary pressure and relative permeability results were claimed to be consistent with their spontaneous imbibition experimental results, leading to the conclusion that wettability alteration is dominated by diffusion, as shown by the initially limited recovery rate and wettability alteration, which is a key element that must be taken into account in simulation studies. Aladasani and colleagues [184] developed a model for LSW in carbonate reservoirs to calculate the capillary pressure and relative permeability, as a function of phase saturations and salt as a mass component in the water phase, based on the published coreflooding experiment results by Yousef et al. [38] and validated their simulation results with the coreflooding experimental results. Their simulation indicated that, in a neutral-wetting state, incremental oil recovery could be controlled by low capillary pressure, and an increase in relative permeability is the principal mechanism for LSW. Al-Shalabi et al. [185,186] simulated reservoir wettability to advocate that EDL expansion is a primary mechanism for LSW in carbonates, based on recently published coreflood experiments conducted by Yousef et al. [38]. Their simulation suggested that wettability modification has a minor impact on water relative permeability, which is consistent with an EDL expansion mechanism. Qiao et al. [187] modelled wettability alteration in carbonates by using a reaction network to capture the competitive surface reactions between carboxylic groups, cations, and  $\text{SO}_4^{2-}$  ions. Their model was developed, based on the published experimental results from spontaneous imbibition tests on Stevns Klint chalk [65], and then used to predict oil recovery for various conditions, where increased recovery, up to 30% of OOIP, was observed. Their simulation results indicated that increasing  $\text{SO}_4^{2-}$  anions concentration can improve oil recovery up to 40% of OOIP, whereas increasing the concentration  $\text{Ca}^{2+}$  cations reduced oil recovery by 5% of OOIP. Additionally, they predicted an optimum brine concentration of 0.096 mol/kg for  $\text{SO}_4^{2-}$  ions, a moderate concentration of cations, and a total ionic salinity of injected brine of 0.2 mol/kg for LSW of chalks.

### 3.4. Field Studies

There is only a limited amount of reports available in the open literature, concerning LSW treatment in carbonates at field scale. Performing pilot waterflooding on the chalk Ekofisk field located in the Norwegian sector of the North Sea, Thomas and co-workers [188,189] demonstrated the potential of LSW in carbonates, where a significant increase in oil recovery rate was observed (30% over a two-year waterflooding period). The Ekofisk field is a thick, heterogeneous, low permeability, and



fractured chalk reservoir with a high temperature (130 °C) with a crude oil AN of about 0.1 mg KOH/g. Fathi et al. [65] showed, via laboratory investigation, that oil recovery can be improved by 10% of the OOIP by using NaCl depleted seawater. Additionally, because the reservoir is running at a high temperature,  $\text{SO}_4^{2-}$  ions should not be added to the injected brine, due to potential precipitation of anhydrite. Furthermore, Webb et al. [15] reported that seawater improved oil recovery from the Valhall field in the North Sea considerably (40%) compared to  $\text{SO}_4^{2-}$  depleted formation water. The Valhall field is an oil-wet fractured chalk field with a temperature of 90 °C with a crude oil AN of 0.35 mg KOH/g. Therefore, due to the low reservoir temperature, considerable oil recovery improvement can be achieved by removing NaCl and adding up to four times the inherent  $\text{SO}_4^{2-}$  ionic concentration to the injected seawater, which indicated oil recovery improvement up to 25% of the OOIP at the laboratory scale [65].

Additionally, significant oil recovery improvement was reported by injection of seawater from the Persian Gulf, transported by pipelines to the desert, into a Saudi Arabian non-fractured limestone reservoir [3]. Moreover, Yousef et al. [37] reported the first ever field trials of LSW in Saudi Arabian carbonate reservoirs to examine the effect of ionic salinity (up to 5 kppm) on oil recovery for secondary and tertiary recovery modes, where a single well chemical tracer was used to determine the residual oil saturation after LSW. Their results showed great potential of LSW in tertiary and secondary oil recovery modes, where reduction of residual oil, by seven units beyond conventional waterflooding, was observed. Wettability alteration is confirmed as a primary mechanism for improved oil recovery and argued that variation in oil recovery efficiency varies for carbonate reservoirs, due to a different reservoir temperature and the chemistry of the initial formation water, oil properties and reservoir heterogeneity.

#### 4. Proposed Mechanisms

Based on the literature, there are several mechanisms elaborated on improving oil recovery when performing LSW, which are dependent on the type of crude oil, reservoir conditions, and the properties of the formation brine [76]. Wettability alteration of rock surfaces towards a more desirable state for oil to be recovered during LSW is widely accepted as a primary reason for improved oil recovery efficiencies during LSW. Even though most of the published work [36,38,58,63,65,66,88,123] links improved oil recovery to wettability alteration to a more water-wet condition by creating thicker and more stable water film, only a handful of reports [135,184,190,191] attributed wettability alteration to a mixed-wet condition. Almost all studies agree that the injection of low salinity water alters the wettability of rock to improve oil recovery. However, there are inconsistencies regarding the fundamental mechanisms of wettability alteration in carbonates, and the following section outlines the principles of each mechanism. Therefore, all mechanisms mentioned in this section can lead to wettability alteration. In other words, wettability alteration is the result of LSW, but not the cause of it.

##### 4.1. Multicomponent Ionic Exchange

The mechanism of multicomponent ionic exchange (MIE) in chalk [20,59,61–63,121,192,193] and reservoir limestone [20,46,59] was first proposed by Austad and co-workers. They suggested that the presence of MIE between the injected brine and the rock surface results in a reduction of ionic bonding between oil molecules and rock surface, which is a dominant mechanism of improved oil recovery during LSW (Figure 9). The mechanism of MIE in carbonates is attributed to the exchange of anions, including adsorption of potential determining anions ( $\text{SO}_4^{2-}$ ) and co-adsorption of divalent cations ( $\text{Ca}^{2+}$  and  $\text{Mg}^{2+}$ ) onto the rock surface, resulting in desorption, and consequently release of negatively charged fatty acid components of crude oil from the rock surface. According to this mechanism,  $\text{SO}_4^{2-}$  ions act as a catalytic agent and adsorb onto the carbonate rock surface, decreasing the positive surface charge density. This minimizes electrostatic repulsive forces, and results in co-adsorption of  $\text{Ca}^{2+}$  and cations on the rock surface. The  $\text{Ca}^{2+}$  ions can then react with carboxylic acid groups that are bonded to the rock surface, thus breaking the attractive interactions between the oil and rock interface. Consequently, carboxylic acid components are released from the rock surface and the

wettability of the rock surface is altered to a more water-wet condition. Additionally, it is suggested that, at high temperature (above 90 °C),  $Mg^{2+}$  ions can substitute  $Ca^{2+}$  ions on the carbonate surface and, therefore, displace surface bonded  $Ca^{2+}$  ions that are also bonded to carboxylic acid molecules, causing them to be released in the form of calcium-carboxylate complexes, thereby further improving oil recovery [65,129]. As a result, the presence of divalent cations ( $Ca^{2+}$  and  $Mg^{2+}$ ) in brine can affect the ability of anions ( $SO_4^{2-}$ ) to adsorb on carbonate surfaces [29,30]. Additionally, it was explained that the mechanism of MIE could also occur at high brine salinity given that the injected brine includes a different relative concentration of active ions compared to the formation water [60]. The mechanism of MIE for carbonate (limestone) cores containing anhydrite is suggested to be similar to chalk cores, the only difference is that  $SO_4^{2-}$  ions are generated from the rock matrix, due to anhydrite dissolution [62]. The MIE mechanism is suggested to be valid for dolomite as well [62]. However, the MIE was not observed by Ravari et al. [116] using outcrop limestone, where negligible increase in concentration of  $Ca^{2+}$  ions and decrease in concentration of  $Mg^{2+}$  and  $SO_4^{2-}$  ions were observed. Even higher temperature and increasing contact time between the rock surface and the injected brine did not result in substitution of  $Ca^{2+}$  ions with  $Mg^{2+}$  ions. Moreover, Zahid and co-workers [69] observed the MIE for outcrop chalk cores by LSW, but not for anhydrite free reservoir carbonate (limestone) cores. However, they claimed that MIE did not result in any additional oil recovery from the chalk cores. Therefore, the mechanism of MIE is dependent on the rock mineralogy and is not valid for all carbonate rock types.

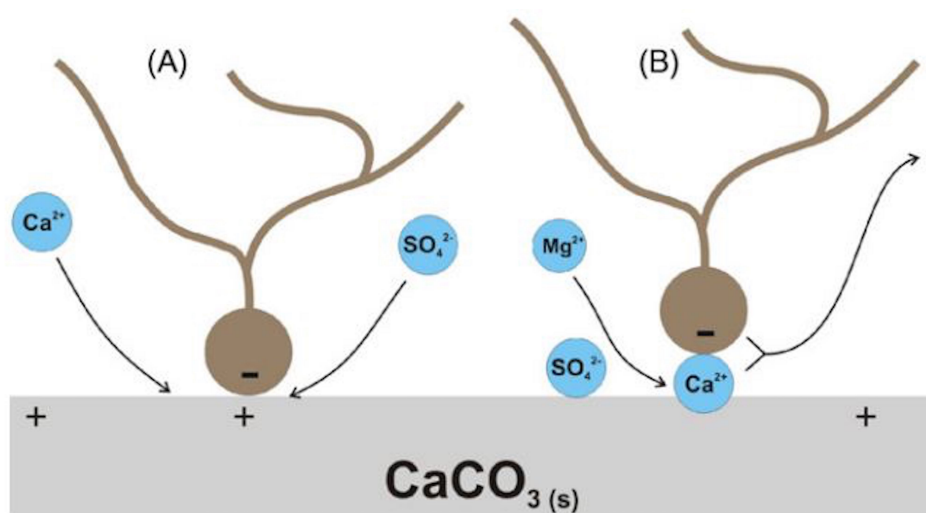

**Figure 9.** Schematic model for proposed wettability alteration mechanism by LSW when: (A)  $Ca^{2+}$  and  $SO_4^{2-}$  ions act as PDIs toward carbonate surface at low and high temperature; and (B)  $Mg^{2+}$  and  $SO_4^{2-}$  ions act as PDIs toward carbonate surface at high temperature from [63]. Reproduced with permission from Zhang et al., *Colloids Surf. A*; published by Elsevier, 2007.

#### 4.2. Rock Dissolution

Dissolution of calcite was proposed as a mechanism for wettability alteration of chalks, by Hiorth et al. [85,169,170], using a geochemical thermodynamic model, based on experimental spontaneous imbibition tests conducted by Austad and co-workers [52,63,64,125,194]. Hiorth et al. suggested that changes in surface potential cannot describe the improvement in oil recovery with changes in pore water chemistry or temperature. Instead, they rationalized that lowering the concentration of  $Ca^{2+}$  ions could result in dissolution of calcium carbonates to restore the equilibrium with the brine. Such chemical dissolution of calcite will release the adsorbed polar components of crude oil from the rock surface, consequently improving water-wetness. Additionally, anhydrite and dolomite dissolutions are suggested to play a role in LSW improved oil recovery [62,195]. Although some

researchers [27,30,31,38,43,66,67,69,80] have identified that rock dissolution may be one of the possible mechanisms for LSW in carbonates, Austad et al. [126] strongly disagreed with the mechanism of calcite dissolution proposed by Hiroth et al. [169], based on published experimental results, where they questioned the applicability of the geochemical model to calculate the chemical equilibrium between calcite and seawater during few days of spontaneous imbibition at high temperature (70–130 °C). It was argued that under these conditions a large portion of minerals will be supersaturated, resulting in the precipitation of minerals in the solution; therefore, a chemical equilibrium at rock–brine interfaces cannot be calculated precisely to define mineral dissolution by their geochemical model. Furthermore, it was argued that mineral dissolution cannot be a mechanism for improved oil recovery, based on spontaneous imbibition and coreflooding tests where incremental oil recovery was observed for samples from the same geological formation without dissolution of salt mineral [88,133]. Mahani et al. [26,164] demonstrated that improved oil recovery happens in the absence of mineral dissolution, arguing that surface charge modification is probable to be the primary mechanism for LSW, which is good news for field application, as calcite dissolution will not contribute at a reservoir scale. Therefore, even though rock dissolution is suggested by some authors, based on the thermodynamic geochemical modelling, currently there is no experimental result that validates this mechanism.

#### 4.3. Fines Migration

A mechanism of fines migration and stripping of oil bearing particles from rock surfaces in sandstones was proposed by Bernard et al. [196], and Tang and Morrow [12]. Both teams suggested that fines migration could help with improving the water-wetness condition, as released movable particles can potentially block some pore throats, in turn diverting the fluid flow and increasing the microscopic sweep efficiency, while reducing permeability. Therefore, the fines migration can lead to improvement in rock water-wetness condition. Additionally, an increase in pressure drop is experienced during LSW processes in carbonates, as reported in the literature [63,68–70]. However, Lager et al. [54] suggested that fines migration is not a mechanism of low salinity oil recovery improvement, but a phenomenon of MIE, based on coreflooding experiments under reservoir conditions, where improved oil recovery, without fines migration or permeability reduction, was observed. RezaeiDoust et al. [60] supported the argument and suggested that diversion of the original flow path would be a more important result than wettability alteration by fines migration. The mechanism of fines migration in LSW was initially proposed for sandstone reservoirs; however, later, this mechanism also has been suggested for carbonates by some researchers [69,70,80], who performed experimental coreflooding tests. Additionally, it is suggested that LSW can result in anhydrite and dolomite dissolution, and consequently fines migration [119,154,195]. Therefore, to acknowledge fines migration as a mechanism for carbonates, petrophysical analysis of rock samples before and after performing LSW is required [80].

#### 4.4. Reduction of Interfacial Tension and Role of pH

Increased pH and reduced interfacial tension (IFT) can result in reduction of the residual oil saturation, and are a possible mechanism during LSW [16]. It is believed that reduction of IFT results in an increase in capillary number, and leads to lower residual oil saturation and improved oil recovery. The residual oil saturation is determined by the ratio of viscous force to capillary force (capillary number) at the end of the waterflooding process. In LSW treatment, reduced salinity and ionic composition have insignificant effect on viscosity; therefore, changes in capillary force will have the dominant impact on the residual oil saturation. Capillary force is a primary mechanism, causing the injected brine to be imbibed into the matrix micropores where oil is bound, and it becomes stronger as the wettability of the rock is altered toward a more water-wet condition. To reduce residual oil saturation, a substantial reduction in capillary force, which is determined by fluid–fluid and fluid–rock interactions, is required. However, whether performing LSW affects IFT (fluid–fluid interactions), contact angle (fluid–rock interactions), or both of them is not clearly established in the literature. Meng and co-workers [130] concluded that wettability

alteration and reduction of IFT could be the two dominant mechanisms for LSW in carbonates. However, Yousef et al. [38,68] claimed that brine salinity has a negligible impact on the IFT of crude oil and seawater compared to contact angle measurements. Therefore, it is probable that LSW has a more significant impact on rock–brine interactions (contact angle) than oil–brine interactions (IFT). Furthermore, some experimental studies showed no correlation between LSW and an increase in pH [16,72]. Therefore, even though the mechanism of reduction of IFT in carbonates is suggested by some authors [130,173,178], others [18,25,38,68,131,134] argued that variation in pH value and reduction of IFT are not the primary causes of LSW oil recovery improvement.

#### 4.5. Fluid–Fluid Interactions and Formation of Microemulsions

Interactions at oil–brine interfaces and formation of water micro-dispersions was proposed as a potential mechanism for LSW oil recovery improvement by Sohrabi and co-workers [197–199] using micromodels at reservoir conditions. It was suggested that when low salinity brine as opposed to high salinity formation water comes into contact with crude oil, water micro-dispersions are formed inside the oil phase, which results in oil recovery improvement due to depletion of natural surface active compound from the oil–brine interface, as well as swelling of high salinity formation water droplets. It was explained that depletion of surface active materials from oil–brine interface, results in changes in the balance between binding and repulsive forces at rock–brine and oil–brine interfaces and consequently alters wettability. In addition, formation of water micro-dispersions in case of low salinity brine and their coalescence at the high salinity formation water, leads to swelling of the formation water, redistribution of fluids, and consequently release of trapped crude oil. It should be noted that injection of low salinity brine only improved oil recovery when a mixed-wet system and a high salinity formation water was used. Additionally, Alvarado et al. [176,200] suggested that improved oil recovery during LSW is due to fluid–fluid interactions and an increase in oil–brine interfacial viscoelasticity, which suppress the trapped oil by snap-off. It was explained that by reducing concentration of the injected brine, regardless of type of ions present in the brine, viscoelasticity of the film at the oil–brine interface is increased and the effect of interfacial film breakage (snap-off) is decreased. Therefore, the oil phase becomes more continuous and larger oil droplets block the pore throat and improve flow of the low salinity brine in non-swept oil bearing pore throats, thus decrease the residual oil saturation and increase oil recovery. Similarly, increase in oil–brine interfacial viscoelasticity at low salt concentration, resulting in reduction of pressure fluctuations and decrease of the oil phase snap-off and, consequently enhanced oil recovery was proposed as a mechanism for LSW [175]. Furthermore, osmosis was proposed as a mechanism for LSW, where the oil phase inside a porous medium acts as a semipermeable membrane and only passes brine with low ionic strength due to sudden changes in osmosis gradient [201]. It was suggested that osmosis expansion of the formation water, which results in relocation of oil phase inside a porous medium could be a potential mechanism of LSW. Lastly, a mechanism of formation of water-in-oil microdispersions (with diameter of 50  $\mu\text{m}$ ) due to oil–brine interactions, which results in increased sweep efficiency was suggested for improved oil recovery by LSW [81]. It was argued that the presence of divalent cations (e.g.,  $\text{Ca}^{2+}$ ) in the injected brine results in stability of water-in-oil microdispersions in order to maintain the continuous oil phase and block the pore throats to improve sweep efficiency.

#### 4.6. Expansion of Electric Double Layer

A mechanism of electric double layer (EDL) expansion was first suggested by Ligthelm et al. [20], who explained that brine with a high salinity, containing a high level of multivalent cations, can interact with negatively charged oil surfaces, thereby screening any repulsive forces and compressing the EDL. This results in a more oil-wet state and suppresses oil recovery. They suggested that the wettability alteration towards increasing water-wetness is responsible for the low salinity oil recovery, due to the increased thickness of the EDL surrounding the oil droplets and rock particles. Expansion of the EDL increases the electrostatic repulsive forces between oil–brine and rock–brine interfaces and, therefore,

creates a thicker and more stable water film on the rock surface, thereby altering the wettability by increasing the water-wet condition. This was further confirmed by Fathi and co-workers who explained that, as the concentration of NaCl in seawater is much higher than for PDIs ( $\text{Ca}^{2+}$ ,  $\text{Mg}^{2+}$ , and  $\text{SO}_4^{2-}$ ), the EDL surrounding a charged rock surface contains a large amount of ions that are inactive in the wettability alteration process and do not form part of the inner Stern layer, which prevents access of active ions to the rock surface [79]. Therefore, NaCl depleted seawater results in EDL expansion and wettability alteration [179]. Additionally, increasing the pH above the carbonate point of zero charge density, changes the rock–brine interface from positive to negative, resulting in repulsive electrostatic forces between the rock–brine and the negatively charged oil–brine interfaces. This results in an increase in the disjoining pressure and expansion of the EDL [202]. Similarly, it was explained that when rock–brine and oil–brine interfaces have the same sign of electrostatic charge, the electrostatic repulsive force will increase, resulting in an increase in the disjoining pressure and creating a thicker and more water-wet film [99,145]. The mechanism of EDL expansion has been suggested, by some researchers [25,42,65,87,164,179,184,186,203], for wettability alteration and LSW oil recovery improvement in carbonates (Figure 10).

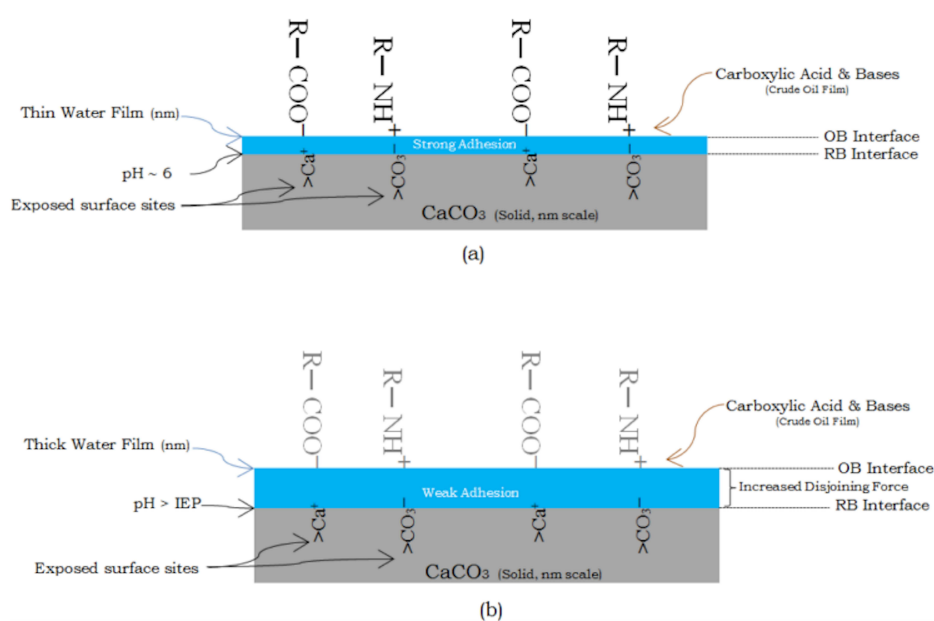

**Figure 10.** Schematic view of suggested mechanism for wettability alteration by expansion of EDL: (a) original wetting condition; and (b) low salinity brine condition from [42]. Reproduced with permission from Sohal et al., *Energy Fuels*; published by American Chemical Society, 2016.

## 5. Conclusions

This review collates evidence to show that LSW has a great potential to improve oil recovery in carbonates. However, LSW is a very complicated technique that is dependent on different variables, such as the specific reservoir conditions and oil–rock–brine interactions. Therefore, it is difficult to apply a brine formulation that suits all systems and conditions and, in order to design an optimized injection brine for a specific type of reservoir, it is essential to gain a mechanistic understanding of the wettability alteration at oil–rock–brine interfaces under controlled laboratory conditions by investigating the effect of individual ions and mixture of ions, as well as different oil components on surface charge modification and wettability alteration of different carbonate mineral surfaces, as the suggested primary mechanisms differ depending on the type of carbonate minerals.

A review of the available literature shows that mechanisms involved at both rock–brine and oil–brine interfaces, such as wettability alteration and fluid–fluid interactions, can play a role in



enhanced oil recovery during LSW. Surface charge modification of carbonate mineral surfaces, due to MIE between PDIs, present in the injected brine, and carbonate rock surfaces, as well as expansion of EDL, due to modification of electrostatic forces between rock surface and carboxylic acid materials in line with the DLVO theory, results in an increase in the disjoining pressure and wettability alteration of rock surfaces by creating thicker and more stable water film on the rock surface, and, therefore, desorption and release of crude oil components from the rock surface and, consequently, improved oil recovery. Alternatively, dissolution of carbonate minerals resulting in increased concentration of  $\text{Ca}^{2+}$  ions in the brine leads to alteration of the brine pH and therefore expansion of EDL and wettability alteration to improve oil recovery. Additionally, alteration of the brine composition could modify oil–brine interactions and improve oil recovery as a result of fluid–fluid interactions and formation of microemulsions, by enhancing the sweep efficiency. Therefore, a single mechanism is incapable of explaining all oil production outcomes observed for LSW, especially in consideration of the large variation in key parameters between reservoirs, as there are many different variables involved in LSW in carbonates. There are also issues in the underpinning empirical data that have been obtained for such systems, as the nature of oil–rock–brine interactions is complex and there are inconsistencies in the experimental studies reported in the literature. Consequently, there might either be a number of mechanisms, or even an undiscovered mechanism, playing a role in LSW improved oil recovery processes and this work suggests greater rigour is required in experimental studies, which may also benefit from the use of advanced techniques, including atomic force microscopy, together with symbiotic modelling studies at realistic reservoir conditions.

**Acknowledgments:** MHD thanks the Energy Technology Partnership (ETP) for a PhD scholarship (ETP 120). Z.J.Z. thanks the support from EPSRC Impact Acceleration Account via the University of Birmingham.

**Conflicts of Interest:** The authors declare no conflict of interest.

## References

1. Kokal, S.; Al-Kaabi, A. Enhanced oil recovery: Challenges & opportunities. *World Pet. Coun. Off. Publ.* **2010**, *64*.
2. Terry, R.E. *Encyclopedia of Physical Science and Technology*, 3rd ed.; Academic Press: San Diego, CA, USA, 2001; Volume 18.
3. Sheng, J. *Enhanced Oil Recovery Field Case Studies*; Elsevier Science: San Diego, CA, USA, 2013.
4. Lyons, W.C.; Plisga, G.J. *Standard Handbook of Petroleum and Natural Gas Engineering*; Gulf Professional Publishing: Houston, TX, USA, 2011.
5. Lake, L.W. *Enhanced Oil Recovery*; Prentice Hall Englewood Cliffs: Upper Saddle River, NJ, USA, 1989.
6. Reiter, P.K. A Water-Sensitive Sandstone Flood Using Low Salinity Water. Ph.D. Thesis, University of Oklahoma, Norman, OK, USA, 1961.
7. Jadhunandan, P.P. Effects of Brine Composition, Crude Oil, and Aging Conditions on Wettability and Oil Recovery. Ph.D. Thesis, Department of Petroleum Engineering, New Mexico Institute of Mining & Technology, Socorro, NM, USA, 1990.
8. Jadhunandan, P.; Morrow, N. Spontaneous imbibition of water by crude oil/brine/rock systems. *In Situ (USA)* **1991**, *15*, 4.
9. Jadhunandan, P.; Morrow, N.R. Effect of wettability on waterflood recovery for crude-oil/brine/rock systems. *Soc. Pet. Eng. Reserv. Eng.* **1995**, *10*, 40–46. [[CrossRef](#)]
10. Yildiz, H.O.; Morrow, N.R. Effect of brine composition on recovery of Moutray crude oil by waterflooding. *J. Pet. Sci. Eng.* **1996**, *14*, 159–168. [[CrossRef](#)]
11. Tang, G.; Morrow, N.R. Salinity, temperature, oil composition, and oil recovery by waterflooding. *Soc. Pet. Eng. Reserv. Eng.* **1997**, *12*, 269–276. [[CrossRef](#)]
12. Tang, G.Q.; Morrow, N.R. Influence of brine composition and fines migration on crude oil/brine/rock interactions and oil recovery. *J. Pet. Sci. Eng.* **1999**, *24*, 99–111. [[CrossRef](#)]
13. Webb, K.; Black, C.; Al-Ajeel, H. Low salinity oil recovery-log-inject-log. In *Proceedings of the Middle East Oil & Gas Show and Conference, 9–12 June 2003*; Society of Petroleum Engineers: Manama, Bahrain, 2003.

14. Webb, K.; Black, C.; Edmonds, I. Low salinity oil recovery—The role of reservoir condition corefloods. In Proceedings of the IOR 2005-13th European Symposium on Improved Oil Recovery, Budapest, Hungary, 25–27 April 2005.
15. Webb, K.J.; Black, C.J.J.; Tjetland, G. A laboratory study investigating methods for improving oil recovery in carbonates. In Proceedings of the International Petroleum Technology Conference, Doha, Qatar, 21–23 November 2005.
16. McGuire, P.; Chatham, J.; Paskvan, F.; Sommer, D.; Carini, F. Low salinity oil recovery: An exciting new EOR opportunity for Alaska's North Slope. In Proceedings of the Society of Petroleum Engineers Western Regional Meeting, Irvine, CA, USA, 30 March–1 April 2005.
17. Robertson, E.P. *Low-Salinity Waterflooding to Improve Oil Recovery—Historical Field Evidence*; Technical Report; Idaho National Laboratory (INL): Idaho Falls, ID, USA, 2007.
18. Lager, A.; Webb, K.J.; Collins, I.R.; Richmond, D.M. LoSal enhanced oil recovery: Evidence of enhanced oil recovery at the reservoir scale. In *Society of Petroleum Engineers Symposium on Improved Oil Recovery*; Society of Petroleum Engineers: Tulsa, OK, USA, 2008.
19. Seccombe, J.; Lager, A.; Jerauld, G.; Jhaveri, B.; Buikema, T.; Bassler, S.; Denis, J.; Webb, K.; Cockin, A.; Fueg, E. Demonstration of low-salinity EOR at interwell scale, Endicott field, Alaska. In *Society of Petroleum Engineers Improved Oil Recovery Symposium*; Society of Petroleum Engineers: Tulsa, OK, USA, 2010.
20. Ligthelm, D.J.; Gronsveld, J.; Hofman, J.; Brussee, N.; Marcelis, F.; van der Linde, H. Novel waterflooding strategy By manipulation Of injection brine composition. In Proceedings of the EUROPEC/EAGE Conference and Exhibition, Amsterdam, The Netherlands, 8–11 June 2009; Society of Petroleum Engineers: Tulsa, OK, USA, 2009.
21. Nasralla, R.A.; Sergienko, E.; Masalmeh, S.K.; van der Linde, H.A.; Brussee, N.J.; Mahani, H.; Suijkerbuijk, B.M.; Al-Qarshubi, I.S. Potential of low-salinity waterflood to improve oil recovery in carbonates: Demonstrating the effect by qualitative coreflood. *Soc. Pet. Eng. J.* **2016**, *21*, 1643–1654. [[CrossRef](#)]
22. Nasralla, R.A.; Mahani, H.; van der Linde, H.A.; Marcelis, F.H.; Masalmeh, S.K.; Sergienko, E.; Brussee, N.J.; Pieterse, S.G.; Basu, S. Low Salinity waterflooding for a carbonate reservoir: Experimental evaluation and numerical interpretation. *J. Pet. Sci. Eng.* **2018**, *164*, 640–654. [[CrossRef](#)]
23. Vledder, P.; Gonzalez, I.E.; Carrera Fonseca, J.C.; Wells, T.; Ligthelm, D.J. Low salinity water flooding: Proof of wettability alteration on a field wide scale. In Proceedings of the Society of Petroleum Engineers Improved Oil Recovery Symposium, Tulsa, OK, USA, 24–28 April 2010.
24. Mahani, H.; Sorop, T.; Ligthelm, D.J.; Brooks, D.; Vledder, P.; Mozahem, F.; Ali, Y. Analysis of field responses to low-salinity waterflooding in secondary and tertiary mode in Syria. In Proceedings of the Society of Petroleum Engineers EUROPEC/EAGE Annual Conference and Exhibition, Vienna, Austria, 23–26 May 2011.
25. Mahani, H.; Menezes, R.; Berg, S.; Fadili, A.; Nasralla, R.; Voskov, D.; Joekar-Niasar, V. Insights into the impact of temperature on the wettability alteration by low salinity in carbonate rocks. *Energy Fuels* **2017**, *31*, 7839–7853. [[CrossRef](#)]
26. Mahani, H.; Keya, A.L.; Berg, S.; Nasralla, R. Electrokinetics of carbonate/brine interface in low-salinity waterflooding: Effect of brine salinity, composition, rock type, and pH on  $\zeta$ -potential and a surface-complexation model. *Soc. Pet. Eng. J.* **2017**, *22*, 53–68.
27. Gupta, R.; Smith, G.G.; Hu, L.; Willingham, T.; Lo Cascio, M.; Shyeh, J.J.; Harris, C.R. Enhanced waterflood for carbonate reservoirs-impact of injection water composition. In Proceedings of the Society of Petroleum Engineers Middle East Oil and Gas Show and Conference, Manama, Bahrain, 25–28 September 2011.
28. Gupta, R.; Lu, P.; Glotzbach, R.; Hehmeyer, O. A Novel, field-representative enhanced-oil-recovery coreflood method. *Soc. Pet. Eng. J.* **2015**, *20*, 442–452. [[CrossRef](#)]
29. Abdallah, W.; Gmira, A. Wettability assessment and surface compositional analysis of aged calcite treated with dynamic water. *Energy Fuels* **2013**, *28*, 1652–1663. [[CrossRef](#)]
30. Kasha, A.; Al-Hashim, H.; Abdallah, W.; Taherian, R.; Sauerer, B. Effect of  $\text{Ca}^{2+}$ ,  $\text{Mg}^{2+}$  and  $\text{SO}_4^{2-}$  ions on the zeta potential of calcite and dolomite particles aged with stearic acid. *Colloids Surf. A Physicochem. Eng. Asp.* **2015**, *482*, 290–299. [[CrossRef](#)]
31. Al-Hashim, H.; Kasha, A.A.; Abdallah, W.; Sauerer, B. Impact of modified seawater on zeta potential and morphology of calcite and dolomite aged with stearic acid. *Energy Fuels* **2018**, *32*, 1644–1656. [[CrossRef](#)]

32. Soraya, B.; Malick, C.; Philippe, C.; Bertin, H.J.; Hamon, G. Oil recovery by low-salinity brine injection: Laboratory results on outcrop and reservoir cores. In Proceedings of the Society of Petroleum Engineers Annual Technical Conference and Exhibition, New Orleans, LA, USA, 4–7 October 2009.
33. Cissokho, M.; Bertin, H.; Boussour, S.; Cordier, P.; Hamon, G. Low salinity oil recovery on clayey sandstone: Experimental study. *Petrophysics* **2010**, *51*.
34. Ashraf, A.; Hadia, N.; Torsaeter, O.; Tweheyo, M.T. Laboratory investigation of low salinity waterflooding as secondary recovery process: Effect of wettability. In Proceedings of the Society of Petroleum Engineers Oil and Gas India Conference and Exhibition, Mumbai, India, 20–22 January 2010.
35. Skrettingland, K.; Holt, T.; Tweheyo, M.T.; Skjevraak, I. Snorre low-salinity-water injection–coreflooding experiments and single-well field pilot. *Soc. Pet. Eng. Reserv. Eval. Eng.* **2011**, *14*, 182–192. [[CrossRef](#)]
36. Kazankapov, N. Enhanced oil recovery in Caspian carbonates with “smart water”. In Proceedings of the Society of Petroleum Engineers Russian Oil and Gas Exploration & Production Technical Conference and Exhibition, Moscow, Russia, 14–16 October 2014.
37. Yousef, A.A.; Al-Saleh, S.; Al-Jawfi, M.S. Improved/enhanced oil recovery from carbonate reservoirs by tuning injection water salinity and ionic content. In Proceedings of the Society of Petroleum Engineers Improved Oil Recovery Symposium, Tulsa, OK, USA, 14–18 April 2012.
38. Yousef, A.A.; Al-Saleh, S.; Al-Kaabi, A.U.; Al-Jawfi, M.S. Laboratory investigation of novel oil recovery method for carbonate reservoirs. In Proceedings of the Canadian Unconventional Resources and International Petroleum Conference, Calgary, AB, Canada, 19–21 October 2010; Society of Petroleum Engineers: Tulsa, OK, USA, 2010.
39. Shaker Shiran, B.; Skauge, A. Enhanced oil recovery (EOR) by combined low salinity water/polymer flooding. *Energy Fuels* **2013**, *27*, 1223–1235. [[CrossRef](#)]
40. Matthiesen, J.; Bovet, N.; Hilner, E.; Andersson, M.P.; Schmidt, D.; Webb, K.; Dalby, K.N.; Hassenkam, T.; Crouch, J.; Collins, I. How naturally adsorbed material on minerals affects low salinity enhanced oil recovery. *Energy Fuels* **2014**, *28*, 4849–4858. [[CrossRef](#)]
41. Jerauld, G.R.; Webb, K.J.; Lin, C.Y.; Secombe, J. Modeling low-salinity waterflooding. In Proceedings of the Society of Petroleum Engineers Annual Technical Conference and Exhibition, San Antonio, TX, USA, 24–27 September 2006.
42. Sohal, M.A.; Thyne, G.; Søgaaard, E.G. Review of recovery mechanisms of ionically modified waterflood in carbonate reservoirs. *Energy Fuels* **2016**, *30*, 1904–1914. [[CrossRef](#)]
43. Chandrasekhar, S.; Sharma, H.; Mohanty, K.K. Wettability alteration with brine composition in high temperature carbonate rocks. In Proceedings of the Society of Petroleum Engineers Annual Technical Conference and Exhibition, Dubai, UAE, 26–28 September 2016.
44. Akbar, M.; Vissapragada, B.; Alghamdi, A.H.; Allen, D.; Herron, M.; Carnegie, A.; Dutta, D.; Olesen, J.R.; Chourasiya, R.; Logan, D. A snapshot of carbonate reservoir evaluation. *Oilfield Rev.* **2000**, *12*, 20–21.
45. Marathe, R.; Turner, M.L.; Fogden, A. Pore-scale distribution of crude oil wettability in carbonate rocks. *Energy Fuels* **2012**, *26*, 6268–6281. [[CrossRef](#)]
46. Myint, P.C.; Firoozabadi, A. Thin liquid films in improved oil recovery from low-salinity brine. *Curr. Opin. Colloid Interface Sci.* **2015**, *20*, 105–114. [[CrossRef](#)]
47. Gomari, K.R.; Hamouda, A. Effect of fatty acids, water composition and pH on the wettability alteration of calcite surface. *J. Pet. Sci. Eng.* **2006**, *50*, 140–150. [[CrossRef](#)]
48. Sauerer, B.; Stukan, M.; Abdallah, W.; Derkani, M.H.; Fedorov, M.; Buiting, J.; Zhang, Z.J. Quantifying mineral surface energy by scanning force microscopy. *J. Colloid Interface Sci.* **2016**, *472*, 237–246. [[CrossRef](#)] [[PubMed](#)]
49. Karimi, M.; Al-Maamari, R.S.; Ayatollahi, S.; Mehranbod, N. Mechanistic study of wettability alteration of oil-wet calcite: The effect of magnesium ions in the presence and absence of cationic surfactant. *Colloids Surf. A Physicochem. Eng. Asp.* **2015**, *482*, 403–415. [[CrossRef](#)]
50. Gomari, K.R.; Denoyel, R.; Hamouda, A. Wettability of calcite and mica modified by different long-chain fatty acids (C18 acids). *J. Colloid Interface Sci.* **2006**, *297*, 470–479. [[CrossRef](#)] [[PubMed](#)]
51. Badri, M.; El-Banbi, A.; Montaron, B. The Schlumberger commitment to carbonate reservoirs. *Middle East Asia Reserv. Rev.* **2009**, 4–15.
52. Puntervold, T.; Strand, S.; Austad, T. Coinjection of seawater and produced water to improve oil recovery from fractured North Sea chalk oil reservoirs. *Energy Fuels* **2009**, *23*, 2527–2536. [[CrossRef](#)]

53. Montaron, B. Defining the challenges of carbonate reservoirs. *Middle East Asia Reserv. Rev.* **2009**, *9*, 16–23.
54. Lager, A.; Webb, K.; Black, C. Impact of brine chemistry on oil recovery. In Proceedings of the IOR 2007-14th European Symposium on Improved Oil Recovery, Cairo, Egypt, 22 April 2007.
55. Lager, A.; Webb, K.J.; Black, C.; Singleton, M.; Sorbie, K.S. Low salinity oil recovery-an experimental investigation1. *Petrophysics* **2008**, *49*.
56. Seccombe, J.C.; Lager, A.; Webb, K.J.; Jerauld, G.; Fueg, E. Improving wateflood recovery: LoSalTM EOR field evaluation. In Proceedings of the Society of Petroleum Engineers Symposium on Improved Oil Recovery, Tulsa, Oklahoma, USA, 20–23 April 2008.
57. Zhang, Y.; Morrow, N.R. Comparison of secondary and tertiary recovery with change in injection brine composition for crude-oil/sandstone combinations. In Proceedings of the Society of Petroleum Engineers/DOE Symposium on Improved Oil Recovery, Tulsa, OK, USA, 22–26 April 2006.
58. Strand, S.; Høgnesen, E.J.; Austad, T. Wettability alteration of carbonates—Effects of potential determining ions ( $\text{Ca}^{2+}$  and  $\text{SO}_4^{2-}$ ) and temperature. *Colloids Surf. A Physicochem. Eng. Asp.* **2006**, *275*, 1–10. [[CrossRef](#)]
59. Strand, S.; Austad, T.; Puntervold, T.; Høgnesen, E.J.; Olsen, M.; Barstad, S.M.F. “Smart water” for oil recovery from fractured limestone: A preliminary study. *Energy Fuels* **2008**, *22*, 3126–3133. [[CrossRef](#)]
60. RezaeiDoust, A.; Puntervold, T.; Strand, S.; Austad, T. Smart water as wettability modifier in carbonate and sandstone: A discussion of similarities/differences in the chemical mechanisms. *Energy Fuels* **2009**, *23*, 4479–4485. [[CrossRef](#)]
61. Austad, T.; Strand, S.; Høgnesen, E.; Zhang, P. Seawater as IOR fluid in fractured chalk. In Proceedings of the Society of Petroleum Engineers International Symposium on Oilfield Chemistry, The Woodlands, TX, USA, 2–4 February 2005.
62. Austad, T.; Shariatpanahi, S.; Strand, S.; Black, C.; Webb, K. Conditions for a low-salinity enhanced oil recovery (EOR) effect in carbonate oil reservoirs. *Energy Fuels* **2011**, *26*, 569–575. [[CrossRef](#)]
63. Zhang, P.; Tweheyo, M.T.; Austad, T. Wettability alteration and improved oil recovery by spontaneous imbibition of seawater into chalk: Impact of the potential determining ions  $\text{Ca}^{2+}$ ,  $\text{Mg}^{2+}$ , and  $\text{SO}_4^{2-}$ . *Colloids Surf. A Physicochem. Eng. Asp.* **2007**, *301*, 199–208. [[CrossRef](#)]
64. Strand, S.; Puntervold, T.; Austad, T. Effect of temperature on enhanced oil recovery from mixed-wet chalk cores by spontaneous imbibition and forced displacement using seawater. *Energy Fuels* **2008**, *22*, 3222–3225. [[CrossRef](#)]
65. Fathi, S.J.; Austad, T.; Strand, S. “Smart water” as a wettability modifier in chalk: The effect of salinity and ionic composition. *Energy Fuels* **2010**, *24*, 2514–2519. [[CrossRef](#)]
66. Yousef, A.A.; Al-Salehsalah, S.H.; Al-Jawfi, M.S. New recovery method for carbonate reservoirs through tuning the injection water salinity: Smart waterflooding. In Proceedings of the Society of Petroleum Engineers EUROPEC/EAGE Annual Conference and Exhibition, Vienna, Austria, 23–26 May 2011.
67. Yousef, A.A.; Al-Saleh, S.; Al-Jawfi, M.S. The impact of the injection water chemistry on oil recovery from carbonate reservoirs. In Proceedings of the Society of Petroleum Engineers EOR Conference at Oil and Gas West Asia, Muscat, Oman, 16–18 April 2012.
68. Yousef, A.A.; Al-Saleh, S.H.; Al-Kaabi, A.; Al-Jawfi, M.S. Laboratory investigation of the impact of injection-water salinity and ionic content on oil recovery from carbonate reservoirs. *Soc. Pet. Eng. Reserv. Eval. Eng.* **2011**, *14*, 578–593. [[CrossRef](#)]
69. Zahid, A.; Shapiro, A.A.; Skauge, A. Experimental studies of low salinity water flooding carbonate: A new promising approach. In Proceedings of the Society of Petroleum Engineers Enhanced Oil Recovery Conference at Oil and Gas West Asia, Muscat, Oman, 16–18 April 2012.
70. Winoto, W.; Loahardjo, N.; Xie, S.X.; Yin, P.; Morrow, N.R. Secondary and tertiary recovery of crude oil from outcrop and reservoir rocks by low salinity waterflooding. In Proceedings of the Society of Petroleum Engineers Improved Oil Recovery Symposium, Tulsa, OK, USA, 14–18 April 2012.
71. Agbalaka, C.C.; Dandekar, A.Y.; Patil, S.L.; Khataniar, S.; Hemsath, J.R. Coreflooding studies to evaluate the impact of salinity and wettability on oil recovery efficiency. *Transp. Porous Media* **2009**, *76*, 77. [[CrossRef](#)]
72. Zhang, Y.; Xie, X.; Morrow, N.R. Waterflood performance by injection of brine with different salinity for reservoir cores. In Proceedings of the Society of Petroleum Engineers Annual Technical Conference and Exhibition, Anaheim, CA, USA, 11–14 November 2007.
73. Nasralla, R.A.; Nasr-El-Din, H.A. Double-layer expansion: Is it a primary mechanism of improved oil recovery by low-salinity waterflooding? *Soc. Pet. Eng. Reserv. Eval. Eng.* **2014**, *17*, 49–59. [[CrossRef](#)]



74. Rivet, S.; Lake, L.W.; Pope, G.A. A coreflood investigation of low-salinity enhanced oil recovery. In Proceedings of the Society of Petroleum Engineers Annual Technical Conference and Exhibition, Florence, Italy, 19–22 September 2010.
75. Nasralla, R.A.; Nasr-El-Din, H.A. Impact of electrical surface charges and cation exchange on oil recovery by low salinity water. In Proceedings of the Society of Petroleum Engineers Asia Pacific Oil and Gas Conference and Exhibition, Jakarta, Indonesia, 20–22 September 2011.
76. Austad, T.; RezaeiDoust, A.; Puntervold, T. Chemical mechanism of low salinity water flooding in sandstone reservoirs. In Proceedings of the Society of Petroleum Engineers improved oil recovery symposium, Tulsa, OK, USA, 24–28 April 2010.
77. Morrow, N.; Buckley, J. Improved oil recovery by low-salinity waterflooding. *J. Pet. Technol.* **2011**, *63*, 106–112. [[CrossRef](#)]
78. Awolayo, A.; Sarma, H.; AlSumaiti, A.M. A laboratory study of ionic effect of smart water for enhancing oil recovery in carbonate reservoirs. In Proceedings of the Society of Petroleum Engineers EOR Conference at Oil and Gas West Asia, Muscat, Oman, 31 March–2 April 2014.
79. Fathi, S.J.; Austad, T.; Strand, S. Water-based enhanced oil recovery (EOR) by “smart water”: Optimal ionic composition for EOR in carbonates. *Energy Fuels* **2011**, *25*, 5173–5179. [[CrossRef](#)]
80. Yi, Z.; Sarma, H.K. Improving waterflood recovery efficiency in carbonate reservoirs through salinity variations and ionic exchanges: A promising low-cost “smart-waterflood” approach. In Proceedings of the Abu Dhabi International Petroleum Conference and Exhibition, Abu Dhabi, UAE, 11–14 November 2012.
81. Tetteh, J.T.; Rankey, E.; Barati, R. Low Salinity Waterflooding Effect: Crude Oil/Brine Interactions as a Recovery Mechanism in Carbonate Rocks. In *OTC Brasil; Offshore Technology Conference: Rio de Janeiro, Brazil*, 2017.
82. Tian, H.; Wang, M. Electrokinetic mechanism of wettability alternation at oil-water-rock interface. *Surf. Sci. Rep.* **2018**, *72*, 369–391. [[CrossRef](#)]
83. Afekare, D.A.; Radonjic, M. From mineral surfaces and coreflood experiments to reservoir implementations: Comprehensive review of low-salinity water flooding (LSWF). *Energy Fuels* **2017**, *31*, 13043–13062. [[CrossRef](#)]
84. Purswani, P.; Tawfik, M.S.; Karpyn, Z.T. Factors and mechanisms governing wettability alteration by chemically tuned waterflooding: A review. *Energy Fuels* **2017**, *31*, 7734–7745. [[CrossRef](#)]
85. Hiorth, A.; Cathles, L.; Madland, M. The impact of pore water chemistry on carbonate surface charge and oil wettability. *Transp. Porous Media* **2010**, *85*, 1–21. [[CrossRef](#)]
86. Crabtree, M.; Eslinger, D.; Fletcher, P.; Miller, M.; Johnson, A.; King, G. Fighting scale—Removal and prevention. *Oilfield Rev.* **1999**, *11*, 30–45.
87. Shariatpanahi, S.F.; Strand, S.; Austad, T. Initial wetting properties of carbonate oil reservoirs: Effect of the temperature and presence of sulfate in formation water. *Energy Fuels* **2011**, *25*, 3021–3028. [[CrossRef](#)]
88. Romanuka, J.; Hofman, J.; Ligthelm, D.J.; Suijkerbuijk, B.; Marcelis, F.; Oedai, S.; Brussee, N.; van der Linde, H.; Aksulu, H.; Austad, T. Low salinity EOR in carbonates. In Proceedings of the Society of Petroleum Engineers Improved Oil Recovery Symposium, Tulsa, OK, USA, 14–18 April 2012.
89. Khatib, Z.; Salanitro, J. Reservoir souring: Analysis of surveys and experience in sour waterfloods. In Proceedings of the Society of Petroleum Engineers Annual Technical Conference and Exhibition, San Antonio, TX, USA, 5–8 October 1997.
90. Bódi, T. Direct and indirect connate water saturation determination methods in the practice of Rias Tibor Bódi. In Proceedings of the Conference & Exhibition on Earth Sciences and Environmental Protection, Miskolc-Egyetemváros, Hungary, 27–29 September 2012.
91. Morrow, N.R.; Xie, X. Oil recovery by spontaneous imbibition from weakly water-wet rocks. *Petrophysics* **2001**, *42*.
92. Puntervold, T.; Strand, S.; Austad, T. Water flooding of carbonate reservoirs: Effects of a model base and natural crude oil bases on chalk wettability. *Energy Fuels* **2007**, *21*, 1606–1616. [[CrossRef](#)]
93. Puntervold, T.; Strand, S.; Austad, T. New method to prepare outcrop chalk cores for wettability and oil recovery studies at low initial water saturation. *Energy Fuels* **2007**, *21*, 3425–3430. [[CrossRef](#)]
94. Denekas, M.; Mattax, C.; Davis, G. Effects of crude oil components on rock wettability. *Soc. Pet. Eng.* **1959**, *216*, 330–333.



95. Mullins, O.C.; Sabbah, H.; Eyssautier, J.; Pomerantz, A.E.; Barré, L.; Andrews, A.B.; Ruiz-Morales, Y.; Mostowfi, F.; McFarlane, R.; Goual, L. Advances in asphaltene science and the Yen–Mullins model. *Energy Fuels* **2012**, *26*, 3986–4003. [[CrossRef](#)]
96. Breure, B.; Subramanian, D.; Leys, J.; Peters, C.J.; Anisimov, M.A. Modeling asphaltene aggregation with a single compound. *Energy Fuels* **2012**, *27*, 172–176. [[CrossRef](#)]
97. Sabbaghi, S.; Jahanmiri, A.; Ayatollahi, S.; Shariaty Niassar, M.; Mansoori, G.A. Characterization of asphaltene using potential energy and nanocalculation. *Iran. J. Chem. Chem. Eng. (IJCCE)* **2008**, *27*, 47–58.
98. Akbarzadeh, K.; Hammami, A.; Kharrat, A.; Zhang, D.; Allenson, S.; Creek, J.; Kabir, S.; Jamaluddin, A.; Marshall, A.G.; Rodgers, R.P. Asphaltenes—Problematic but rich in potential. *Oilfield Rev.* **2007**, *19*, 22–43.
99. Dubey, S.; Doe, P. Base number and wetting properties of crude oils. *Soc. Pet. Eng. Reserv. Eng.* **1993**, *8*, 195–200. [[CrossRef](#)]
100. Zhang, P.; Austad, T. The relative effects of acid number and temperature on chalk wettability. In Proceedings of the Society of Petroleum Engineers International Symposium on Oilfield Chemistry, The Woodlands, TX, USA, 2–4 February 2005.
101. Fathi, S.J.; Austad, T.; Strand, S. Effect of water-extractable carboxylic acids in crude oil on wettability in carbonates. *Energy Fuels* **2011**, *25*, 2587–2592. [[CrossRef](#)]
102. Standnes, D.C.; Austad, T. Wettability alteration in chalk: 1. Preparation of core material and oil properties. *J. Pet. Sci. Eng.* **2000**, *28*, 111–121. [[CrossRef](#)]
103. Standnes, D.C.; Austad, T. Wettability alteration in chalk: 2. Mechanism for wettability alteration from oil-wet to water-wet using surfactants. *J. Pet. Sci. Eng.* **2000**, *28*, 123–143. [[CrossRef](#)]
104. Fathi, S.J.; Austad, T.; Strand, S.; Puntervold, T. Wettability alteration in carbonates: The effect of water-soluble carboxylic acids in crude oil. *Energy Fuels* **2010**, *24*, 2974–2979. [[CrossRef](#)]
105. Thomas, M.M.; Clouse, J.A.; Longo, J.M. Adsorption of organic compounds on carbonate minerals: 1. Model compounds and their influence on mineral wettability. *Chem. Geol.* **1993**, *109*, 201–213. [[CrossRef](#)]
106. Mwangi, P.; Thyne, G.; Rao, D. Extensive experimental wettability study in sandstone and carbonate-oil-brine systems: Part 1—Screening tool development. In Proceedings of the International Symposium of the Society of Core Analysts, Napa Valley, CA, USA, 16–19 September 2013; pp. 16–19.
107. Gomari, K.R.; Hamouda, A.; Davidian, T.; Fargland, D. Study of the effect of acidic species on wettability alteration of calcite surfaces by measuring partitioning coefficients, IFT and contact angles. *Contact Angle Wettabil. Adhes.* **2006**, *4*, 351–367.
108. Rao, D.N. Wettability effects in thermal recovery operations. In Proceedings of the Society of Petroleum Engineers/DOE Improved Oil Recovery Symposium, Tulsa, OK, 21–24 April 1996.
109. Shimoyama, A.; Johns, W.D. Formation of alkanes from fatty acids in the presence of CaCO<sub>3</sub>. *Geochim. Cosmochim. Acta* **1972**, *36*, 87–91. [[CrossRef](#)]
110. Heidari, M.A.; Habibi, A.; Ayatollahi, S.; Masihi, M.; Ashoorian, S. Effect of time and temperature on crude oil aging to do a right surfactant flooding with a new approach. In Proceedings of the Offshore Technology Conference-Asia, Kuala Lumpur, Malaysia, 25–28 March 2014.
111. Zhang, P.; Tweheyo, M.T.; Austad, T. Wettability alteration and improved oil recovery in chalk: The effect of calcium in the presence of sulfate. *Energy Fuels* **2006**, *20*, 2056–2062. [[CrossRef](#)]
112. Sohal, M.A.; Kucheryavskiy, S.; Thyne, G.; Søggaard, E.G. Study of ionically modified water performance in the carbonate reservoir system by multivariate data analysis. *Energy Fuels* **2017**, *31*, 2414–2429. [[CrossRef](#)]
113. Buckley, J. Asphaltene precipitation and crude oil wetting. *Soc. Pet. Eng. Adv. Technol. Ser.* **1995**, *3*, 53–59. [[CrossRef](#)]
114. Austad, T.; Strand, S.; Puntervold, T.; Ravari, R.R. New method to clean carbonate reservoir cores by seawater. Presented at the SCA2008-15 International Symposium of the Society of Core Analysts, Abu Dhabi, UAE, 29 October–2 November 2008; Volume 29.
115. Fathi, S.J.; Austad, T.; Strand, S.; Frank, S.; Mogensen, K. Evaluation of EOR potentials in an offshore limestone reservoir: A case study. In Proceedings of the Eleventh International Symposium on Reservoir Wettability, Calgary, AB, Canada, 6–8 September 2010; pp. 7–9.
116. Ravari, R.R. Water-Based EOR in Limestone by Smart Water: A Study of Surface Chemistry. Ph.D. Thesis, University of Stavanger, Stavanger, Norway, 2011.
117. Shariatpanahi, S.; Strand, S.; Austad, T.; Aksulu, H. Wettability restoration of limestone cores using core material from the aqueous zone. *Pet. Sci. Technol.* **2012**, *30*, 1082–1090. [[CrossRef](#)]

118. Fernø, M.; Grønsdal, R.; Åsheim, J.; Nyheim, A.; Berge, M.; Graue, A. Use of sulfate for water based enhanced oil recovery during spontaneous imbibition in chalk. *Energy Fuels* **2011**, *25*, 1697–1706. [[CrossRef](#)]
119. Pu, H.; Xie, X.; Yin, P.; Morrow, N.R. Application of coalbed methane water to oil recovery from Tensleep sandstone by low salinity waterflooding. In Proceedings of the Society of Petroleum Engineers Symposium on Improved Oil Recovery, Tulsa, OK, USA, 20–23 April 2008.
120. Korsnes, R.; Strand, S.; Hoff, Ø.; Pedersen, T.; Madland, M.; Austad, T. Does the chemical interaction between seawater and chalk affect the mechanical properties of chalk. In *Multiphysics Coupling and Long Term Behaviour in Rock Mechanics*; CRC Press: Boca Raton, FL, USA, 2006; pp. 427–434.
121. Puntervold, T. Waterflooding of Carbonate Reservoirs: EOR by Wettability Alteration. Ph.D. Thesis, University of Stavanger, Stavanger, Norway, 2008.
122. Korsnes, R.; Madland, M.; Austad, T. Impact of brine composition on the mechanical strength of chalk at high temperature. In *Eurock, Proceedings of the International Symposium of the International Society for Rock Mechanics, Liège, Belgium, 9–12 May 2006*; Taylor & Francis/Balkema: Ghent, Belgium, 2006; pp. 133–140.
123. Zhang, P.; Austad, T. Wettability and oil recovery from carbonates: Effects of temperature and potential determining ions. *Colloids Surf. A Physicochem. Eng. Asp.* **2006**, *279*, 179–187. [[CrossRef](#)]
124. Strand, S.; Standnes, D.; Austad, T. New wettability test for chalk based on chromatographic separation of  $\text{SCN}^-$  and  $\text{SO}_4^{2-}$ . *J. Pet. Sci. Eng.* **2006**, *52*, 187–197. [[CrossRef](#)]
125. Hognesen, E.J.; Strand, S.; Austad, T. Waterflooding of preferential oil-wet carbonates: Oil recovery related to reservoir temperature and brine composition. In Proceedings of the Society of Petroleum Engineers Europec/EAGE Annual Conference, Madrid, Spain, 13–16 June 2005.
126. Austad, T.; Strand, S.; Puntervold, T. Is wettability alteration of carbonates by seawater caused by rock dissolution? In Proceedings of the SCA International Symposium, Noordwijk, The Netherlands, 27–30 September 2009; p. 2009-43.
127. Shehata, A.M.; Alotaibi, M.B.; Nasr-El-Din, H.A. Waterflooding in carbonate reservoirs: Does the salinity matter? *Soc. Pet. Eng. Reserv. Eval. Eng.* **2014**, *17*, 304–313. [[CrossRef](#)]
128. Brady, P.V.; Thyne, G. Functional wettability in carbonate reservoirs. *Energy Fuels* **2016**, *30*, 9217–9225. [[CrossRef](#)]
129. Fathi, S.J.; Austad, T.; Strand, S. Water-based enhanced oil recovery (EOR) by “smart water” in carbonate reservoirs. In Proceedings of the Society of Petroleum Engineers Enhanced Oil Recovery Conference at Oil and Gas West Asia, Muscat, Oman, 16–18 April 2012.
130. Meng, W.; Haroun, M.; Sarma, H.; Adeoye, J.; Aras, P.; Punjabi, S.; Rahman, M.; Al Kobaisi, M. A novel approach of using phosphate-spiked smart brines to alter wettability in mixed oil-wet carbonate reservoirs. In Proceedings of the Abu Dhabi International Petroleum Exhibition and Conference, Abu Dhabi, UAE, 9–12 November 2015.
131. Sohal, M.A.; Thyne, G.; Søgaard, E.G. Novel application of the flotation technique to measure the wettability changes by ionically modified water for improved oil recovery in carbonates. *Energy Fuels* **2016**, *30*, 6306–6320. [[CrossRef](#)]
132. Alotaibi, M.B.; Azmy, R.; Nasr-El-Din, H.A. Wettability challenges in carbonate reservoirs. In Proceedings of the Society of Petroleum Engineers Improved Oil Recovery Symposium, Tulsa, Oklahoma, USA, 24–28 April 2010.
133. Nasralla, R.A.; Sergienko, E.; Masalmeh, S.K.; van der Linde, H.A.; Brussee, N.J.; Mahani, H.; Suijkerbuijk, B.; Alqarshubi, I. Demonstrating the potential of low-salinity waterflood to improve oil recovery in carbonate reservoirs by qualitative coreflood. In Proceedings of the Abu Dhabi International Petroleum Exhibition and Conference, Abu Dhabi, UAE, 10–13 November 2014.
134. Al Harrasi, A.; Al-maamari, R.S.; Masalmeh, S.K. Laboratory investigation of low salinity waterflooding for carbonate reservoirs. In Proceedings of the Abu Dhabi International Petroleum Conference and Exhibition, Abu Dhabi, UAE, 11–14 November 2012.
135. Al-Attar, H.H.; Mahmoud, M.Y.; Zekri, A.Y.; Almehaideb, R.; Ghannam, M. Low-salinity flooding in a selected carbonate reservoir: Experimental approach. *J. Pet. Explor. Prod. Technol.* **2013**, *3*, 139–149. [[CrossRef](#)]
136. Standnes, D.C.; Nogaret, L.A.; Chen, H.L.; Austad, T. An evaluation of spontaneous imbibition of water into oil-wet carbonate reservoir cores using a nonionic and a cationic surfactant. *Energy Fuels* **2002**, *16*, 1557–1564. [[CrossRef](#)]

137. Jarrahan, K.; Seiedi, O.; Sheykhani, M.; Sefti, M.V.; Ayatollahi, S. Wettability alteration of carbonate rocks by surfactants: A mechanistic study. *Colloids Surf. A Physicochem. Eng. Asp.* **2012**, *410*, 1–10. [[CrossRef](#)]
138. Hirasaki, G.; Zhang, D.L. Surface chemistry of oil recovery from fractured, oil-wet, carbonate formations. *Soc. Pet. Eng. J.* **2004**, *9*, 151–162. [[CrossRef](#)]
139. Yuan, Y.; Lee, T.R. Contact angle and wetting properties. In *Surface Science Techniques*; Springer: New York, NY, USA, 2013; pp. 3–34.
140. Anderson, W. Wettability Literature survey-part 1: Rock/oil/brine interactions and the effects of core handling on wettability. *J. Pet. Technol.* **1986**, 1125–1144. [[CrossRef](#)]
141. Hamouda, A.A.; Rezaei Gomari, K.A. Influence of temperature on wettability alteration of carbonate reservoirs. In Proceedings of the Society of Petroleum Engineers/DOE Symposium on Improved Oil Recovery, Tulsa, OK, USA, 22–26 April 2006.
142. Kafili Kasmaei, A.; Rao, D. Is wettability alteration the main cause for enhanced recovery in low-salinity waterflooding? In Proceedings of the Society of Petroleum Engineers Improved Oil Recovery Symposium, Tulsa, Oklahoma, USA, 12–16 April 2014.
143. Butt, H.J.; Cappella, B.; Kappl, M. Force measurements with the atomic force microscope: Technique, interpretation and applications. *Surf. Sci. Rep.* **2005**, *59*, 1–152. [[CrossRef](#)]
144. Liang, Y.; Hilal, N.; Langston, P.; Starov, V. Interaction forces between colloidal particles in liquid: Theory and experiment. *Adv. Colloid Interface Sci.* **2007**, *134*, 151–166. [[CrossRef](#)] [[PubMed](#)]
145. Jackson, M.D.; Al-Mahrouqi, D.; Vinogradov, J. Zeta potential in oil-water-carbonate systems and its impact on oil recovery during controlled salinity water-flooding. *Sci. Rep.* **2016**, *6*, 37363. [[CrossRef](#)] [[PubMed](#)]
146. Butt, H.J.; Jaschke, M.; Ducker, W. Measuring surface forces in aqueous electrolyte solution with the atomic force microscope. *Bioelectrochem. Bioenerg.* **1995**, *38*, 191–201. [[CrossRef](#)]
147. Seiedi, O.; Rahbar, M.; Nabipour, M.; Emadi, M.A.; Ghatee, M.H.; Ayatollahi, S. Atomic force microscopy (AFM) investigation on the surfactant wettability alteration mechanism of aged mica mineral surfaces. *Energy Fuels* **2010**, *25*, 183–188. [[CrossRef](#)]
148. Zargari, S.; Ostvar, S.; Niazi, A.; Ayatollahi, S. Atomic force microscopy and wettability study of the alteration of mica and sandstone by a biosurfactant-producing bacterium *Bacillus thermodenitrificans*. *J. Adv. Microsc. Res.* **2010**, *5*, 143–148. [[CrossRef](#)]
149. Ducker, W.A.; Senden, T.J.; Pashley, R.M. Direct measurement of colloidal forces using an atomic force microscope. *Nature* **1991**, *353*, 239. [[CrossRef](#)]
150. Vigil, G.; Xu, Z.; Steinberg, S.; Israelachvili, J. Interactions of silica surfaces. *J. Colloid Interface Sci.* **1994**, *165*, 367–385. [[CrossRef](#)]
151. Hartley, P.G.; Larson, I.; Scales, P.J. Electrokinetic and direct force measurements between silica and mica surfaces in dilute electrolyte solutions. *Langmuir* **1997**, *13*, 2207–2214. [[CrossRef](#)]
152. Toikka, G.; Hayes, R.A. Direct measurement of colloidal forces between mica and silica in aqueous electrolyte. *J. Colloid Interface Sci.* **1997**, *191*, 102–109. [[CrossRef](#)] [[PubMed](#)]
153. Liu, J.; Xu, Z.; Masliyah, J. Studies on bitumen-silica interaction in aqueous solutions by atomic force microscopy. *Langmuir* **2003**, *19*, 3911–3920. [[CrossRef](#)]
154. Lebedeva, E.; Senden, T.; Knackstedt, M.; Morrow, N. Improved Oil Recovery from Tensleep Sandstone—Studies of Brine-Rock Interactions by Micro-CT and AFM. In Proceedings of the IOR 2009-15th European Symposium on Improved Oil Recovery, Paris, France, 27–29 April 2009.
155. Karoussi, O.; Skovbjerg, L.L.; Hassenkam, T.; Stipp, S.S.; Hamouda, A.A. AFM study of calcite surface exposed to stearic and heptanoic acids. *Colloids Surf. A Physicochem. Eng. Asp.* **2008**, *325*, 107–114. [[CrossRef](#)]
156. Ricci, M.; Segura, J.J.; Erickson, B.W.; Fantner, G.; Stellacci, F.; Voitchovsky, K. Growth and dissolution of calcite in the presence of adsorbed stearic acid. *Langmuir* **2015**, *31*, 7563–7571. [[CrossRef](#)] [[PubMed](#)]
157. Gomari, K.R.; Hamouda, A.; Denoyel, R. Influence of sulfate ions on the interaction between fatty acids and calcite surface. *Colloids Surf. A Physicochem. Eng. Asp.* **2006**, *287*, 29–35. [[CrossRef](#)]
158. Rezaei Gomari, K.A.; Karoussi, O.; Hamouda, A.A. Mechanistic study of interaction between water and carbonate rocks for enhancing oil recovery. In Proceedings of the Society of Petroleum Engineers Europec/EAGE Annual Conference and Exhibition, Vienna, Austria, 12–15 June 2006.
159. Alroudhan, A.; Vinogradov, J.; Jackson, M. Zeta potential of intact natural limestone: Impact of potential-determining ions Ca, Mg and SO<sub>4</sub>. *Colloids Surf. A Physicochem. Eng. Asp.* **2016**, *493*, 83–98. [[CrossRef](#)]

160. Monfared, A.D.; Ghazanfari, M.; Jamialahmadi, M.; Helalizadeh, A. Adsorption of silica nanoparticles onto calcite: Equilibrium, kinetic, thermodynamic and DLVO analysis. *Chem. Eng. J.* **2015**, *281*, 334–344. [[CrossRef](#)]
161. Al Mahrouqi, D.; Vinogradov, J.; Jackson, M.D. Zeta potential of artificial and natural calcite in aqueous solution. *Adv. Colloid Interface Sci.* **2017**, *240*, 60–76. [[CrossRef](#)] [[PubMed](#)]
162. Mihajlović, S.R.; Vučinić, D.R.; Sekulić, Ž.T.; Miličević, S.Z.; Kolonja, B.M. Mechanism of stearic acid adsorption to calcite. *Powder Technol.* **2013**, *245*, 208–216. [[CrossRef](#)]
163. Nyström, R.; Lindén, M.; Rosenholm, J.B. The influence of  $\text{Na}^+$ ,  $\text{Ca}^{2+}$ ,  $\text{Ba}^{2+}$ , and  $\text{La}^{3+}$  on the  $\zeta$  potential and the yield stress of calcite dispersions. *J. Colloid Interface Sci.* **2001**, *242*, 259–263. [[CrossRef](#)]
164. Mahani, H.; Keya, A.L.; Berg, S.; Bartels, W.B.; Nasralla, R.; Rossen, W.R. Insights into the mechanism of wettability alteration by low-salinity flooding (LSF) in carbonates. *Energy Fuels* **2015**, *29*, 1352–1367. [[CrossRef](#)]
165. Rodríguez, K.; Araujo, M. Temperature and pressure effects on zeta potential values of reservoir minerals. *J. Colloid Interface Sci.* **2006**, *300*, 788–794. [[CrossRef](#)] [[PubMed](#)]
166. Alotaibi, M.B.; Nasr-El-Din, H.A.; Fletcher, J.J. Electrokinetics of limestone and dolomite rock particles. *Soc. Pet. Eng. Reserv. Eval. Eng.* **2011**, *14*, 594–603. [[CrossRef](#)]
167. Mahani, H.; Keya, A.L.; Berg, S.; Nasralla, R. The effect of salinity, rock type and pH on the electrokinetics of carbonate-brine interface and surface complexation modeling. In Proceedings of the Society of Petroleum Engineers Reservoir Characterisation and Simulation Conference and Exhibition, Abu Dhabi, UAE, 14–16 September 2015.
168. Goldberg, S. Sensitivity of surface complexation modeling to the surface site density parameter. *J. Colloid Interface Sci.* **1991**, *145*, 1–9. [[CrossRef](#)]
169. Hiorth, A.; Cathles, L.; Kolnes, J.; Vikane, O.; Lohne, A.; Madland, M. A chemical model for the seawater- $\text{CO}_2$ -carbonate system—aqueous and surface chemistry. In Proceedings of the Wettability Conference, Abu Dhabi, UAE, 29 October–2 November 2008; pp. 27–28.
170. Hiorth, A.; Cathles, L.; Kolnes, J.; Vikane, O.; Lohne, A.; Madland, M. Chemical modelling of wettability change in carbonate rocks. Presented at the 10th Wettability Conference, Abu Dhabi, UAE, 7–28 October 2008; pp. 1–9.
171. Heberling, F.; Trainor, T.P.; Lützenkirchen, J.; Eng, P.; Denecke, M.A.; Bosbach, D. Structure and reactivity of the calcite–water interface. *J. Colloid Interface Sci.* **2011**, *354*, 843–857. [[CrossRef](#)] [[PubMed](#)]
172. Song, J.; Zeng, Y.; Wang, L.; Duan, X.; Puerto, M.; Chapman, W.G.; Biswal, S.L.; Hirasaki, G.J. Surface complexation modeling of calcite zeta potential measurements in brines with mixed potential determining ions ( $\text{Ca}^{2+}$ ,  $\text{CO}_3^{2-}$ ,  $\text{Mg}^{2+}$ ,  $\text{SO}_4^{2-}$ ) for characterizing carbonate wettability. *J. Colloid Interface Sci.* **2017**, *506*, 169–179. [[CrossRef](#)] [[PubMed](#)]
173. Alotaibi, M.; Nasr-El-Din, H. Effect of brine salinity on reservoir fluids interfacial tension. EUROPEC/EAGE Annual Conference and Exhibition, Amsterdam, The Netherlands, 8–11 June 2009. *Pap. Soc. Pet. Eng.* **2009**, *121569*, 1–14.
174. Lashkarbolooki, M.; Ayatollahi, S.; Riazi, M. Effect of salinity, resin, and asphaltene on the surface properties of acidic crude oil/smart water/rock system. *Energy Fuels* **2014**, *28*, 6820–6829. [[CrossRef](#)]
175. Chávez-Miyauchi, T.E.; Firoozabadi, A.; Fuller, G.G. Nonmonotonic elasticity of the crude oil–brine interface in relation to improved oil recovery. *Langmuir* **2016**, *32*, 2192–2198. [[CrossRef](#)] [[PubMed](#)]
176. Alvarado, V.; Garcia-Olvera, G.; Manrique, E. Considerations of adjusted brine chemistry for waterflooding in offshore environments. In Proceedings of the OTC Brasil, Offshore Technology Conference, Rio de Janeiro, Brazil, 27–29 October 2015.
177. Vijapurapu, C.S.; Rao, D.N. Effect of brine dilution and surfactant concentration on spreading and wettability. In Proceedings of the International Symposium on Oilfield Chemistry, Houston, TX, USA, 5–7 February 2003.
178. Okasha, T.M.; Alshiwai, A. Effect of brine salinity on interfacial tension in Arab-D carbonate reservoir, Saudi Arabia. In Proceedings of the Middle East Oil and Gas Show and Conference, Manama, Bahrain, 15–18 March 2009.
179. Alameri, W.; Teklu, T.W.; Graves, R.M.; Kazemi, H.; AlSumaiti, A.M. Wettability alteration during low-salinity waterflooding in carbonate reservoir cores. In Proceedings of the Society of Petroleum Engineers Asia Pacific Oil & Gas Conference and Exhibition, Adelaide, Australia, 14–16 October 2014.



180. Xu, W. Experimental Investigation of Dynamic Interfacial Interactions at Reservoir Conditions. Master's Thesis, Louisiana State University, Baton Rouge, LA, USA, 2005.
181. Ma, S.; Zhang, X.; Morrow, N.; Zhou, X. Characterization of wettability from spontaneous imbibition measurements. *J. Can. Pet. Technol.* **1999**, *38*. [[CrossRef](#)]
182. Masalmeh, S. Impact of capillary forces on residual oil saturation and flooding experiments for mixed to oil-wet carbonate reservoirs. In Proceedings of the International Symposium of the Society of Core Analysts held in Aberdeen (SCA2012-11), Scotland, UK, 27–30 August 2012.
183. Yu, L.; Evje, S.; Kleppe, H.; Karstad, T.; Fjelde, I.; Skjaeveland, S.M. Analysis of the Wettability alteration process during seawater imbibition into preferentially oil-wet chalk cores. In Proceedings of the Society of Petroleum Engineers Symposium on Improved Oil Recovery, Tulsa, OK, USA, 20–23 April 2008.
184. Al-adasani, A.; Bai, B.; Wu, Y.S. Investigating low salinity waterflooding recovery mechanisms in carbonate reservoirs. In Proceedings of the Society of Petroleum Engineers Enhanced Oil Recovery Conference at Oil and Gas West Asia, Muscat, Oman, 16–18 April 2012.
185. Al Shalabi, E.W.; Sepehrnoori, K.; Delshad, M. Mechanisms behind low salinity water injection in carbonate reservoirs. *Fuel* **2014**, *121*, 11–19. [[CrossRef](#)]
186. Al Shalabi, E.W.; Sepehrnoori, K.; Delshad, M. Does the double layer expansion mechanism contribute to the LSWI effect on hydrocarbon recovery from carbonate rocks? In Proceedings of the Society of Petroleum Engineers Reservoir Characterization and Simulation Conference and Exhibition, Abu Dhabi, UAE, 16–18 September 2013.
187. Qiao, C.; Li, L.; Johns, R.T.; Xu, J. A mechanistic model for wettability alteration by chemically tuned water flooding in carbonate reservoirs. In Proceedings of the Society of Petroleum Engineers Annual Technical Conference and Exhibition, Amsterdam, The Netherlands, 27–29 October 2014.
188. Sylte, J.; Hallenbeck, L.; Thomas, L. Ekofisk formation pilot waterflood. In Proceedings of the Society of Petroleum Engineers Annual Technical Conference and Exhibition, Houston, TX, USA, 2–5 October 1988.
189. Hallenbeck, L.; Sylte, J.; Ebbs, D.; Thomas, L. Implementation of the Ekofisk field waterflood. *Soc. Pet. Eng. Form. Eval.* **1991**, *6*, 284–290. [[CrossRef](#)]
190. Sharma, M.; Filoco, P. Effect of brine salinity and crude-oil properties on oil recovery and residual saturations. *Soc. Pet. Eng. J.* **2000**, *5*, 293–300. [[CrossRef](#)]
191. Agbalaka, C.C.; Dandekar, A.Y.; Patil, S.L.; Khataniar, S.; Hemsath, J. The effect of wettability on oil recovery: A review. In Proceedings of the Society of Petroleum Engineers Asia Pacific Oil and Gas Conference and Exhibition, Perth, Australia, 20–22 October 2008.
192. Zhang, P.; Austad, T. Waterflooding in chalk—relationship between oil recovery, new wettability index, brine composition and cationic wettability modifier (Society of Petroleum Engineers94209). In Proceedings of the 67th EAGE Conference & Exhibition, Madrid, Spain, 13–16 June 2005.
193. Austad, T.; Strand, S.; Madland, M.V.; Puntervold, T.; Korsnes, R.I. Seawater in chalk: An EOR and compaction fluid. In Proceedings of the International Petroleum Technology Conference, Dubai, UAE, 4–6 December 2007.
194. Standnes, D.C. Enhanced Oil Recovery from Oil-Wet Carbonate Rock by Spontaneous Imbibition of Aqueous Surfactant Solutions. Ph.D. Thesis, Dibrugarh University, Assam, India, 2001.
195. Pu, H.; Xie, X.; Yin, P.; Morrow, N.R. Low-salinity waterflooding and mineral dissolution. In Proceedings of the Society of Petroleum Engineers Annual Technical Conference and Exhibition, Florence, Italy, 19–22 September 2010.
196. Bernard, G.G. Effect of floodwater salinity on recovery of oil from cores containing clays. In Proceedings of the Society of Petroleum Engineers California Regional Meeting, Los Angeles, CA, USA, 26–27 October 1967.
197. Emadi, A.; Sohrabi, M. Visual investigation of oil recovery by low salinity water injection: Formation of water micro-dispersions and wettability alteration. In Proceedings of the Society of Petroleum Engineers Annual Technical Conference and Exhibition, New Orleans, LA, USA, 30 September–2 October 2013.
198. Mahzari, P.; Sohrabi, M. Crude oil/brine interactions and spontaneous formation of micro-dispersions in low salinity water injection. In Proceedings of the Society of Petroleum Engineers Improved Oil Recovery Symposium, Tulsa, OK, USA, 12–16 April 2014.
199. Sohrabi, M.; Mahzari, P.; Farzaneh, S.A.; Mills, J.R.; Tsois, P.; Ireland, S. Novel insights into mechanisms of oil recovery by use of low-salinity-water injection. *Soc. Pet. Eng. J.* **2017**, *22*, 407–416. [[CrossRef](#)]



200. Alvarado, V.; Moradi Bidhendi, M.; Garcia-Olvera, G.; Morin, B.; Oakey, J.S. Interfacial visco-elasticity of crude oil-brine: An alternative EOR mechanism in smart waterflooding. In Proceedings of the Society of Petroleum Engineers Improved Oil Recovery Symposium, Tulsa, OK, USA, 12–16 April 2014.
201. Sandengen, K.; Kristoffersen, A.; Melhuus, K.; Jøsang, L.O. Osmosis as mechanism for low-salinity enhanced oil recovery. *Soc. Pet. Eng. J.* **2016**, *21*, 1227–1235. [[CrossRef](#)]
202. Takamura, K.; Chow, R.S. The electric properties of the bitumen/water interface Part II. Application of the ionizable surface-group model. *Colloids Surf.* **1985**, *15*, 35–48. [[CrossRef](#)]
203. Al-Shalabi, E.; Sepehrnoori, K.; Pope, G.; Mohanty, K. A Fundamental model for predicting oil recovery due to low salinity water injection in carbonate rocks. In Proceedings of the Society of Petroleum Engineers Energy Resources Conference, Port of Spain, Spain, 9–11 June 2014.



© 2018 by the authors. Licensee MDPI, Basel, Switzerland. This article is an open access article distributed under the terms and conditions of the Creative Commons Attribution (CC BY) license (<http://creativecommons.org/licenses/by/4.0/>).