



**UNIVERSITY OF LEEDS**

This is a repository copy of *Topology Optimisation of Lattice Telecommunication Tower and Performance-Based Design Considering Wind and Ice Loads*.

White Rose Research Online URL for this paper:  
<https://eprints.whiterose.ac.uk/164057/>

Version: Accepted Version

---

**Article:**

Tsavdaridis, KD [orcid.org/0000-0001-8349-3979](https://orcid.org/0000-0001-8349-3979), Nicolaou, A, Mistry, AD et al. (1 more author) (2020) Topology Optimisation of Lattice Telecommunication Tower and Performance-Based Design Considering Wind and Ice Loads. *Structures*, 27. pp. 2379-2399. ISSN 2352-0124

<https://doi.org/10.1016/j.istruc.2020.08.010>

---

© 2020 Institution of Structural Engineers. Published by Elsevier Ltd. This manuscript version is made available under the CC-BY-NC-ND 4.0 license  
<http://creativecommons.org/licenses/by-nc-nd/4.0/>.

**Reuse**

This article is distributed under the terms of the Creative Commons Attribution-NonCommercial-NoDerivs (CC BY-NC-ND) licence. This licence only allows you to download this work and share it with others as long as you credit the authors, but you can't change the article in any way or use it commercially. More information and the full terms of the licence here: <https://creativecommons.org/licenses/>

**Takedown**

If you consider content in White Rose Research Online to be in breach of UK law, please notify us by emailing [eprints@whiterose.ac.uk](mailto:eprints@whiterose.ac.uk) including the URL of the record and the reason for the withdrawal request.



[eprints@whiterose.ac.uk](mailto:eprints@whiterose.ac.uk)  
<https://eprints.whiterose.ac.uk/>

# Topology Optimisation of Lattice Telecommunication Tower and Performance-Based Design considering Wind and Ice Loads

Konstantinos Daniel Tsavdaridis<sup>1\*</sup>, Andreas Nicolaou<sup>1,2</sup>, Anand Dipak Mistry<sup>1</sup>, and Evangelos Efthymiou<sup>3</sup>

<sup>1</sup>University of Leeds, School of Civil Engineering, Faculty of Engineering and Physical Sciences, Woodhouse Lane, LS2 9JT, Leeds, United Kingdom

<sup>2</sup>Ramboll, 240 Blackfriars Rd, London SE1 8NW, United Kingdom

<sup>3</sup>Aristotle University of Thessaloniki, Institute of Metal Structures, Department of Civil Engineering, Greece

*Corresponding author: [\\*k.tsavdaridis@leeds.ac.uk](mailto:k.tsavdaridis@leeds.ac.uk)*

## ABSTRACT

With increasing demand of infrastructure to support power transmission and telecommunication systems, the need of erecting more towers has also been rising significantly. For many years, these towers were designed by using a conservative approach and the opportunities lying in the design optimisation of the towers were not leveraged. This paper presents the application of structural topology optimisation to lattice self-supported telecommunication towers in developing an improved solution in terms of weight-to-stiffness ratio. 2D and 3D topology optimisation studies were performed with highly optimised bracing systems reducing the amount of steel material used, thus its carbon footprint. The new exoskeleton structure is representing a lattice tower composed of ‘high-waisted’ bracing type and elliptical hollow sections (EHS). Comparative modal analyses demonstrated the structural performance of the optimised tower models. In addition, a research-led design was carried out for optimising the geometric cross-sectional properties of the optimised lattice tower subjected to quasi-static analysis followed by regression analysis. The cross-sectional parameters were progressively changed; explicitly the diameter and thickness of the members. The performance-based analysis and design of a topologically optimised lattice tower present alternatives to onerous approaches such as wind tunnel testing or finite element modelling. The results were further analysed to understand their viability in different loading design cases and the effect of cross-sections. Conclusions highlighted the benefits gained by introducing the structural topology optimisation process in the design of slender support structures.

*Keywords:* structural topology optimisation; lattice telecommunication towers; exoskeleton design; high-waisted bracing; shape optimisation; wind loading; ice loading; quasi-static analysis

## 1 INTRODUCTION

In the last decade, the telecommunication industry has radically changed from conventional operations and systems to data-driven applications, while its further evolution is a necessity in order to meet the new technologies of emerging smart home and smart city concepts. Considering the explosive services demand in cities as a result of population increase, the need for more support structures to be installed within urban framework is deeply felt.

Newly developed equipment (e.g., antennas and dish-reflectors of different size, shape and weight in comparison to those already utilised) are to be supported by lattice broadcasting telecommunication structures. Such telecommunication equipment is mounted on existing towers at different heights, resulting the alteration of the initial design load-carrying scenario, while stressing particular structural components due to their asymmetric distribution (Szafran, 2015). In addition, new equipment such as ancillary antenna support structures, cables, UHF aerials, radio and TV antenna broadcasters, telephone antenna arrays and microwave dishes increase the solidity and surface area of the towers, consequently, the wind drag becomes more intense. As sizes of new microwave antennas may range from 0.6m to 1.2m or 1.5m to 2.4m diameter and around 30kg and 60kg in weight respectively, wind drag and eccentric vertical loadings can increase significantly (United Telecom Limited, 2011). One of the basic design considerations of lattice telecommunication towers is to define clearly possible future extension (Støttrup-Andersen, 2009). However, existing telecommunication towers have not necessarily been designed to that extent to cope with such additional gravitational and lateral forces, hence, there is increased possibility of overloading and damages, that could lead even to the collapse of such slender structures due to the new loading framework. Furthermore, due to the fact that these flexible structures are repeatedly subjected to fluctuating stresses induced by dynamic wind effects, it is very likely that they will undergo fatigue damage. Consequently, old telecommunication masts and towers that suffer fatigue damage may need to be replaced (Pospíšil et al., 2012).

Efthymiou et al. (2009) stated that the consequences to the social and economic domain resulting from the collapse of such structures can be regarded as equally damaging to the consequences caused by the collapse of a bridge or other similar infrastructure. Therefore, under the conditions of improvement and upgrade of the current broadcasting services, in many cases it is deemed necessary to replace the existing old-type lattice towers when rehabilitation is an expensive option (Szafran, 2015; Albermani et al., 2004).

The rapid growth of mobile telecommunication industry ushered in a bright new era for the lattice self-supported towers and guyed masts. Just to get a feeling of the telecom industry's effect in the installation of new towers or masts, Støttrup-Andersen (2014) mentions that 800 of a specific type of towers were created for Connect-Austria in a short period of time. In 2016, WIG announced the investment of £1 billion over a period of 3 years on new telecom infrastructure to improve and extend current networks in the UK and Europe (LS Telecom, 2016); Department for DCMS, 2019). Similarly, in 2014 and 2015 more than 8,000 and 10,000 towers were acquired by IHS in Africa and America Tower in the US, respectively (Tower Xchange, 2015 and 2018). All the aforementioned facts highlight the need for better and more reliable telecommunication services through upgrading and installation of existing and new infrastructure.

The demand for the installation of new towers requires building permits which can be challenging to acquire if the aesthetic value of the concerned structure is not adequate (Nielsen et al., 2006). In addition, the increasing number of masts and towers can cause visual intrusion to the landscape which makes the process of achieving building permit even more difficult (Coventry City Council, 2005; Forest of Dean District Council [online]). A recent attempt by Nielsen and Støttrup-Andersen (2014) to resolve the matter upon discussion suggests that circular hollow sections (CHS) can significantly improve the aesthetic value of the tower by reducing the overall solidity and bracing members of the structure. With that in mind, it is unfortunate that towers with increased solidity are even more noticeable; a distinct

disadvantage in landscaping terms. Therefore, what springs from this situation is the requirement to develop lattice telecommunication towers with improved architectural appearance and reduced solidity while also being able to fulfil structural capability and functional utility demands.

Within this framework, application of structural topology optimisation (STO) in tower design process could lead to novel architectural forms that are lighter and structurally resilient. Optimised structures also manage to provide an aesthetic alternative to the existing telecom infrastructure, which could enhance their social acceptance and facilitating their harmonic integration in cities, resulting thus to their wider installation. In the last decade, researchers have attempted to topology optimise the design of truss-like structures subjected to seismic actions (Hajirasouliha et al., 2011) as well as proposed a new hybrid method for both size and topology optimisation of truss structures using Modified Augmented Lagrangian Genetic Algorithm (ALGA) and Quadratic Penalty Function Genetic Algorithm (QPGA) optimisation method (Noii et al., 2016). On another case, research on design optimisation of 50 m broadcasting antenna guyed masts using Genetic Algorithms serving as a hint for a more precise nonlinear dynamic analysis (Belevičius et al., 2013). Advantages and disadvantages are received for each constructive solution on the basis of the analysis of applicability of the existing and proposed towers structural solutions and evaluation of the stress-strain state performed. According to the criterion of metal consumption, the most economical version is usually chosen while the criteria for optimising atypical towers geometry and their elements are proposed and consist in simultaneously ensuring the requirements of limiting states (Golikov et al., 2018).

This paper develops a new lattice telecommunication tower that fulfils the aforementioned requirements through a structural topology optimisation (STO) process and investigate the potential of employing such process as an alternative design tool. For clarity, the key objectives of this paper are: (a) to produce a series of realistic optimised conceptual layouts through computational STO; (b) to provide a design alternative through STO and introduce elliptical hollow sections (EHS) at the prospect of adopting concentrically loaded connections; and (c) to reduce the number of structural members, hence the solidity and mass of the structure achieving improved weight-to-stiffness characteristics. The final outcome must fulfil the resilience and sustainability criteria and should retain aesthetic value (Kingman et al, 2013; Tsavdaridis et al., 2014 & 2015).

## 1.1 Structural topology optimisation (STO)

Topology optimisation is one of the most advanced structural optimisation technique and it is mainly used at the very early stages of a design for the production of optimal conceptual layouts that represent the skeleton of a structure or a structural component. The production of optimum layout involves optimal material distribution within a designed domain based on the given set of support conditions, loadings, constraints and objectives (Fig. 1) (Olason and Tidman, 2011; Saleem et al., 2008; Tsavdaridis et al., 2014). Following that, the final outcome of a STO analysis is unknown, however, the designer must be able to interpret and explain the resulting topologies.

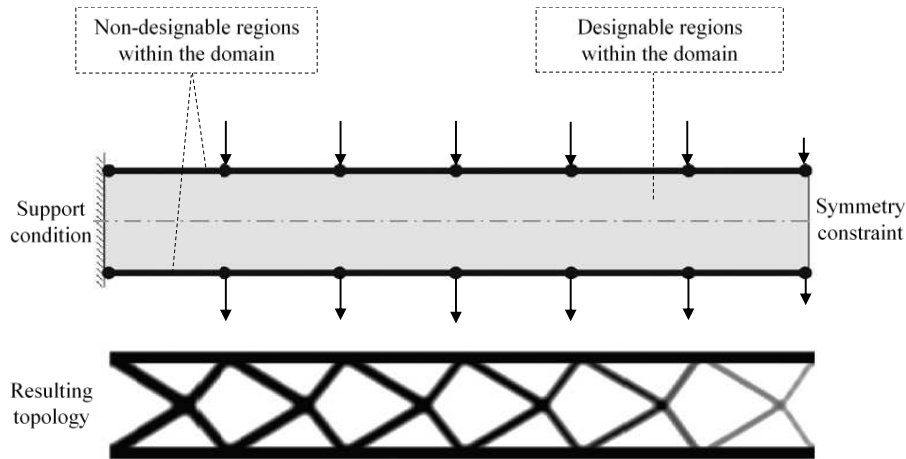

Fig. 1. Design domain: problem formulation and resulting topology (Tsavdaridis et al., 2015).

## 1.2 Topology optimisation methods

Topology optimisation methods are mathematical techniques or approaches, and they can be programmed using different algorithms. These algorithms could be classified as follows: the criterion algorithm, the mathematical programming algorithm, and the intelligent algorithm (Kentli, 2019). Two classes of approaches, the so-called material or micro-approaches and the geometrical or macro-approaches, are available (Li, 2018; Luo et al, 2019). The mainly used methods using discrete elements can be regarded, such as (The Constructor, 2019) ground structure approach (GSA) (Zhang et al., 2017; Shieh, 2994), solid isotropic material with penalisation (SIMP) method (Bensøe, 1989; Bendsoe and Sigmund, 2003; Sigmund and Maute, 2013, Grekavicius et al., 2016a & 2016b, Abdelwahab and Tsavdaridis, 2019), homogenisation-method (HM) (Bendsoe and Kikuchi, 1988; Groen and Sigmund, 2018), evolutionary structural optimisation (ESO) (Xie and Steven, 1993; Jiang and Jia, 2006), and level-set method (LSM) (Jiang and Jia, 2006). On the other hand, the mainly used meshless methods are element-free Galerkin (EFG) (Luo et al., 2013), moving particle (Liu et al., 1995), and peridynamics (Kefal et al., 2019).

The mathematical algorithms employed more often to solve a structural topology optimisation problem are the ESO and the SIMP. In both techniques the finite element (FE) meshing of the domains is necessary. ESO method involves an iterative process where the parameter value (i.e., energy density) is determined specifically for each element. During each iteration, some elements which appear to have the lowest parameter value are eliminated. Following that, this method was criticised by Rozvany (2008) regarding the reliability of what is likely to be declared as the optimal solution. The main disadvantages of this algorithm are: (i) larger number of iterations are required compared to the SIMP method, possibly resulting into non-optimal solutions and increased computational time, and (ii) pre-specified volume fraction ( $V_f$ ) can result into highly unreliable solutions. This paper employs the SIMP algorithm, using Altairs' OptiStruct version 2016. SIMP algorithm requires low number of iterations, and therefore, reduced computational time. It can be used when the optimisation problem involves multiple constraints and varying loading conditions (Rozvany, 2008). In principle, the two algorithms cannot be compared as different objective functions are set in the two methods, hence different optimum solutions can be obtained (Rozvany, 2008).

Although continuum topology optimisation techniques such as SIMP have proved popular, they tend not to perform equally well if the volume fraction is low, in other words if the

component occupies only a small proportion of the available design space. It is worth to note that, topology optimisation approaches may be computationally expensive and often require labour intensive post-processing in order to realise a practical component. In those case, an alternative is to use numerical layout optimisation which is employing a ground structure (Dorn et al., 1964) to generate least-weight truss designs. Such designs can be very structurally efficient, especially when the degree of design freedom is high. Using this method, linear programming (aka LP) can be used to obtain robust and computationally efficient solutions [3,4]. The standard layout optimisation process involves a series of steps starting from the design domain, load and support conditions are specified, generation of nodes inside the design domain where potential members are created by interconnecting these nodes, then forming a ‘ground structure’, and finally the optimal layout is identified by solving the underlying LP problem (Dorn et al., 1964; Gilbert and Tyas, 2003; Pritchard et al., 2005; Linwei et al., 2019).

However, Sigmund and Maute (2013) have published a framework on the classification of methodologies, and they highlighted that differences between topology optimisation approaches become small and an approach evolves into the other by the time such as evolutionary methods are converging towards discrete SIMP schemes. However, this trend has gone forward using hybrid approaches rather than becoming similar techniques to keep all the approaches having their advantages and limitations. There are many studies using hybrid methodologies given before under different headings, but there is still room for new applications. Especially from evolutionary algorithms perspective, using new optimisation algorithms will enable to improve methodologies advanced up to now (Kentli, 2019).

### 1.3 Minimum compliance design

According to Tsavdaridis et al. (2015) when using the SIMP algorithm there are two main approaches for determining the optimum topology layout within a domain. The first approach is known as the ‘minimum weight design’ whereas the second as the ‘minimum compliance design’. Following that, the first approach involves using the minimum amount of mass to determine the topology which satisfies performance associated constraints. Such constraints may be the natural frequency, stress, stiffness, displacements or any combination of these. Alternatively, the second approach objective involves designing to minimise a performance type measure using the available resources as a constraint. In this study, the constraints can be a prescribed amount of material mass or volume and the function objectives can be the stiffness, displacement or other type performance measures (Tsavdaridis et al., 2015 & 2019; Stromberg et al., 2012). This paper employs the second approach having the maximum stiffness as an objective function and volume fraction ( $V_f$ ) as a constraint.

### 1.4 Previous applications

Currently, there is a trend in research and practice to employ computational STO techniques for the design of optimal lateral support systems of slender high-rise buildings and the production of complete building skeletons driven by architects (Stromberg et al., 2010; Beghini et al., 2014; Kingman et al., 2014 & 2015) as well as for the design of novel non-standard lightweight and stiff structural elements (Tsavdaridis et al., 2015 & 2019). Typical examples of the applications mentioned are depicted in Fig. 2.



Fig. 2. Structural topology optimisation techniques on buildings (Stromberg et al., 2010; Beghini et al., 2014; Kingman et al., 2015).

To interpret the results of this paper, resulting topologies of previous studies are employed. These studies aimed in producing topology layouts, appropriate for high-rise building design, using manufacturing constraints such as symmetry and pattern gradation (Stromberg et al., 2010). Topologies such as the optimum cantilever and shear bracing presented within Stromberg et al. (2012) are introduced to explain the conceptual layouts obtained herein.

## 2 CONSTRUCTION OF THE 2D AND 3D DESIGN DOMAINS

To perform the optimisation analyses (OA) and produce a topology layout for the novel morphology of the tower, the 2D and 3D domains must be first created. 2D approach is followed to visualise topologies formed in relation to the domain, loading and boundary conditions and ultimately create a new optimised geometry. The reason for also including a 3D optimisation technique is to explore the ease of generating an entire skeleton with some forms of indication regarding the cross-sections and whether there is correlation with the 2D analysis. The following sections describe the sequence of the optimisation process for the construction of the domains, formation of meshing and establishment of loads and boundary conditions as well as the validation of the results.

### 2.1 Domains computational design and geometrical characteristics

All design domains created are based on the geometry of a steel lattice self-supported tower located in Greece designed to resist wind as well as seismic actions (Fig. 3). The 19m height four-legged tower features square on plan configuration, partially-tapered vertical profile and triangular shaped tip to allow antenna fitting. This structure represents a conventional geometry for lattice telecommunication towers and will be referred in this work to as original tower UA.

Three 2D distinct geometries were formed, all based on the perimeter lines of the tower UA; (i) a fully-tapered (*FT*), (ii) a fully-straight (*FS*), and (iii) a partially-tapered (*PT*) (Fig. 3). The analysis of the domain to produce the most consistent and realistic outcomes shall be considered in the creation of the novel skeleton.

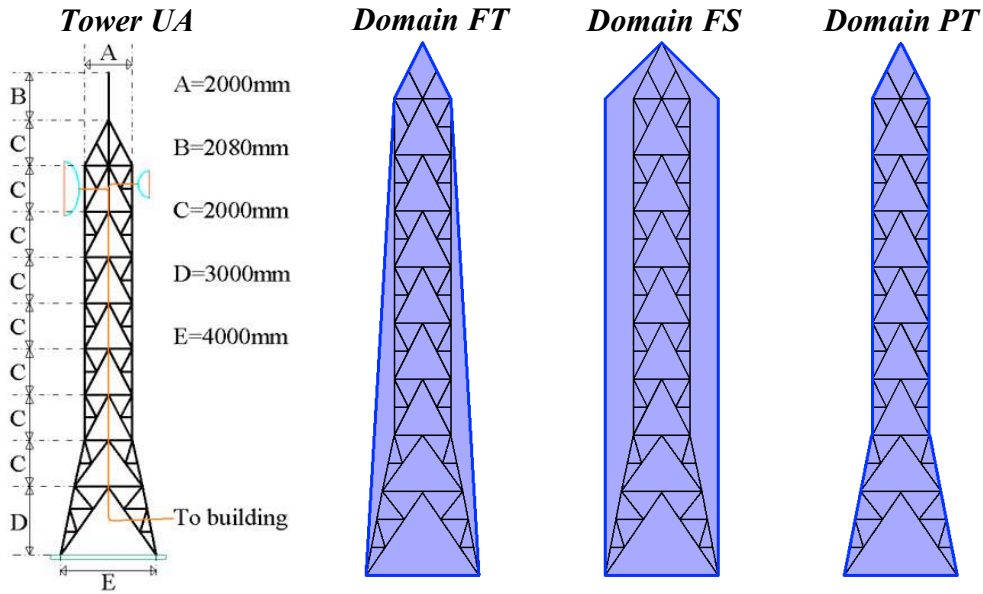

Fig. 3. Developing the 2D domains based on the geometry UA.

The 2D and 3D design domains were formed using the geometry tools of Altair HyperMesh. The formation of the 2D domains involved a process of establishing temporary nodes, connecting the nodes using lines and then converting the areas bounded by the lines to surfaces. Next, to set up the lines to the top and bottom of each panel area, the 'extract parametric' command for the creation of temporary nodes was used. The lines separating each panel will be used later for applying static wind forces at the top and bottom of each panel. As for the 3D domain, similar concepts were applied including the conversion of volume bounded by surfaces into solids using the 'bounding surfaces' command (Fig. 4).

Table 1. Basic characteristics and dimensions of the final designed domains.

Domain	Characteristics			Dimensions (m)					
	Type	Cap	Taper	Base $W$	gridCap $W_c$	widthCap $H_c$	height Taper	height $H_t$	Total height $H$
FT	2D	Yes	Yes	4	2	2	17		19
PT	2D	Yes	Yes	4	2	2	5		19
FS	2D	Yes	No	4	4	2	---		19
FT <sub>3D</sub>	3D	No	Yes	4	---	---	17		17



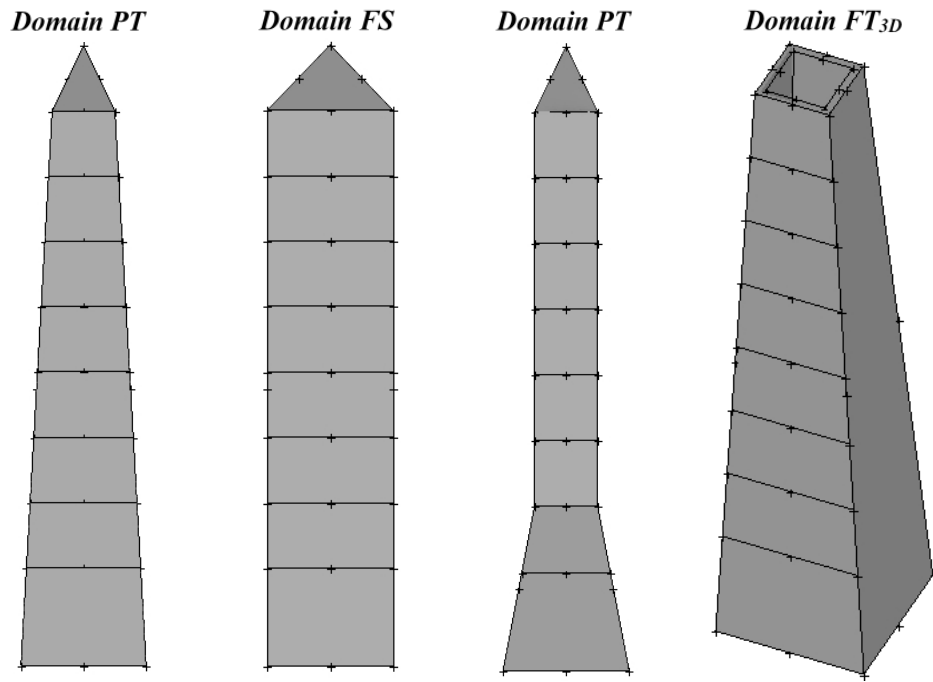

Fig. 4. 2D and 3D design domains in HyperMesh.

## 2.2 Meshing of the domains

For the 2D domains, meshing was achieved using the ‘automesh’ command adopting element density of 20 on the cap and each panel edge lines as shown in Fig. 5. The element type used is the 4-noded quadrilateral elements with assigned thickness of 215mm and PSHELL properties; normally used for ‘sheet’ type domains (Zolekar and Wankhade, 2013; Altair, 2012).

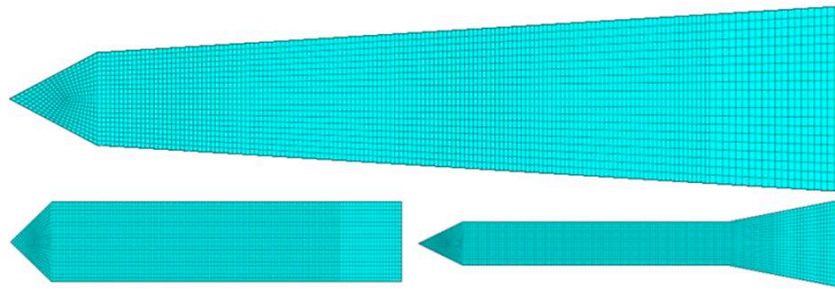
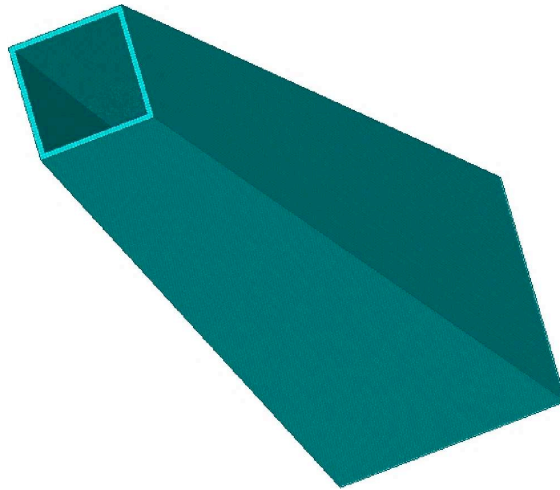

Fig. 5. 2D designed domains meshed in HyperMesh.

Regarding the solid exterior of the 3D domain depicted in Fig. 6, meshing was applied using the ‘automesh’ in conjunction with the ‘linear solid’ command. The elements density and type used in this case were 220 and 8-noded linear hex with PSOLID properties respectively (Zolekar and Wankhade, 2013; Altair, 2012 and 2014).



*Fig. 6.* 3D design domain meshed in HyperMesh.

### 2.3 Loads and boundary conditions

Lattice telecommunication towers are lightweight, tall and flexible and mainly located at high altitudes, thus wind is one of the primary environmental loads that must be considered during analysis and design (Efthymiou et al., 2009; McClure et al., 2009; Madugula, 2002). Due to the flexibility, presence of structural voids and bareness of such structures, dynamic wind interaction phenomena can become particularly interesting (Madugula, 2002; Ballaben et al., 2011; Bechmann, 1995). Hence, many studies, designs and computational tests have been carried out considering static wind loads whose magnitude increases with height (Das and Kumae, 2015; Sharma et al., 2015).

Guidance for predicting the effect of wind on lattice structures is provided by BS EN 1991-1-4 (2005) and German codes DIN 4131 (1991) in conjunction with BS EN 1993-3-1 (2006) and DIN 1991 (2010), respectively (Efthymiou, 2009; Baniotopoulos and Stathopoulos, 2007). Static wind forces are determined in the present study based on Eurocodes assuming the tower is subjected to the worst wind loading scenario that takes place in the UK (BS EN 1991-1-4 (2005)). Both methods rely on the solidity of the structure (Nielsen, 2014; Carril et al., 2003; Eurocode 1, 2005). At this stage, the wind forces are calculated based on the structural arrangement of tower UA. It is worth mentioning that in the optimisation problem formulation, it is crucial to specify how and where the forces are applied, and not their actual magnitude (Olason and Tidman, 2011). This observation has to do with the material distribution due to the generation of stress trajectories based on the location of applied forces and supports.

Moreover, as for the boundary conditions, it is assumed that the full base width of the 2D designed domains is fixed during the optimisation studies. This is to identify the exact location of stress paths generated within the domain, and hence estimate the number and location of columns required in a single tower face. Providing fixities only at the base corners would force the analysis to distribute the material from the top to the bottom two fixities of the domain, and therefore, potentially limit the number of columns. On the other hand, to reduce the computational time of the 3D domain OA and provide a more coherent result, fixities are provided only at the base corners.

Furthermore, the initial analyses are performed considering point loads applied only at the top and at the locations of secondary horizontal bracing members as currently used in the topology of UA model (Fig. 7). It is noticed that by altering the loading scenario to a higher magnitude of distributed load, it has improved the outcome of the analyses by providing coherent and ideal topology layouts.

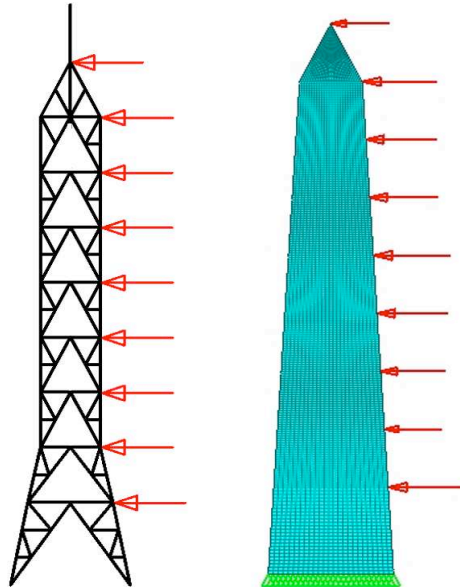

Fig. 7. Initial loading scenario used for the OA.

### 3 TOPOLOGY OPTIMISATION STUDY

The optimisation process followed in this study and the resulting topology layouts within one domain are presented in parallel. The final solutions were progressively developed by mainly changing element thicknesses and introducing symmetry manufacturing constraints. The penalisation factor ( $p$ ) was kept as 1.0 for the analysis of 2D domains. Because of the nature of this structural forms, and considering a static loading scenario, increasing the height causes more material usage in the vertical elements (i.e., the legs) situated closer to the bottom of the guyed mast or tower rather than in the bracing elements to support the tall vertical cantilever. The use of the penalty factor equal to 1.0, assists in identifying whether heavier members are required at the bottom (i.e., by indicating higher density).

As for the 3D domain, in order to obtain a topology which is easier to understand and interpret, a penalisation factor of 3.0 is used [16]. It was also realised that setting the element thickness at 250mm, and volume fractions between 0.2 and 0.3, the output of both types of analyses become coherent.

#### 3.1 First-level optimisation study

The influence of several key parameters such as the element thickness ( $t_e$ ) and volume fraction ( $V_f$ ) on the topology outcome is presented herein. It should be noted that all the OAs presented are performed on the domain FT and the characteristics of each analysis are synopsised in Table 2.

Table 2. Characteristics of the initial optimisation analyses performed.

Analysis	Loading scenario	Support conditions	Maximum iterations	Elements thickness (mm)	$t_e$ Volume fraction (%)	$V_f$
A	Figure 7	Full base fixed	30	250	35	
B	Figure 7	Full base fixed	30	215	25	
C	Figure 7	Full base fixed	60	215	25	

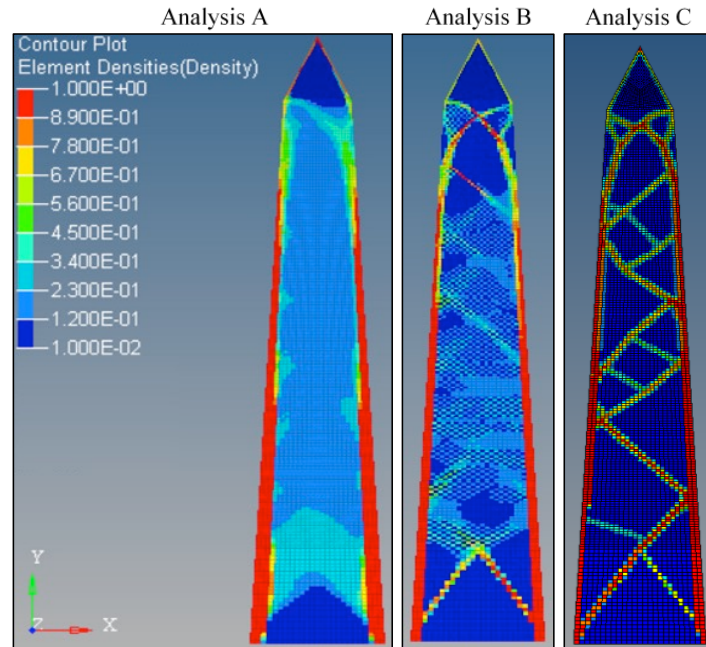
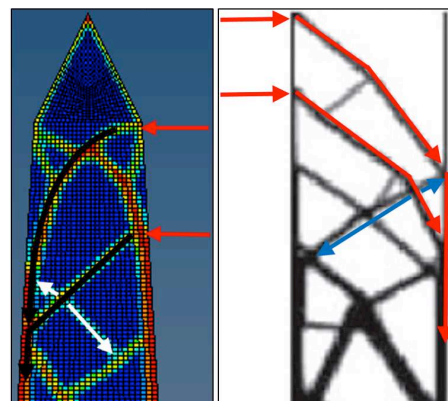

Fig. 8. Progressively improving OA output by altering parameters in Table 2.

Based on Fig. 8 and Table 2, the reduction of the element thickness and volume fraction constraint improved the clarity of the solution with fewer core elements replacing smaller and thinner dense elements (i.e., struts and ties). Analysis C clearly indicated the stress paths required by a single tower face to withstand the loading scenario presented in Fig. 7. In addition, it is confirmed that the final output is dependent on the specified loading scenario and support conditions (Fig. 9). Following that, the material distributed in between the exterior vertical chords (legs) from right to left while acts in compression as it is essential to resist the applied forces (i.e., black arrows in Fig. 9). On the other hand, the material distributed from left to right (opposite direction) is of lower density and it is required for tying the two struts of the system (i.e., white arrows in Fig. 9). Similar results observed from [Stromberg et al. \(2010\)](#).

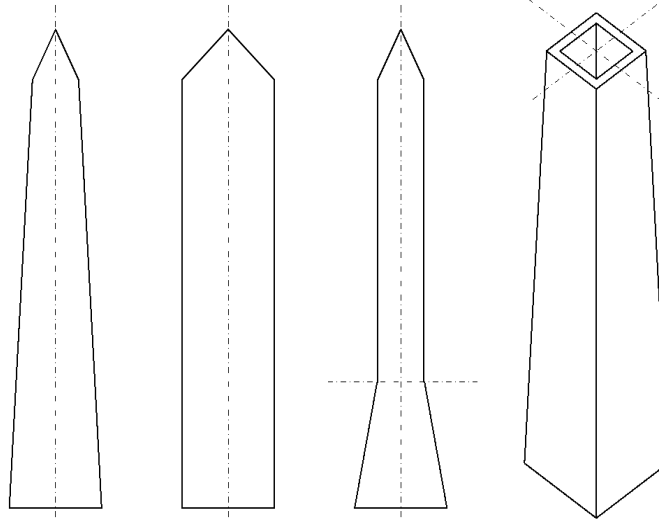

*Fig. 9.* Analysis C top section showing material distribution based on loading scenario and conceptual comparison with the results (right) obtained in [Stromberg et al. \(2010\)](#).

As a conclusion, it can be argued that OA towers can provide satisfactory results leading to a realistic structural formulation. However, the output is limited to the windward loading scenario only, whereas, this is not always going to be the case (i.e., wind may act in different directions despite the known prevailing and dominant wind directions). Hence, the symmetry manufacturing constraints must be introduced to these domains ([Tsavdaridis et al., 2015](#); [Olason and Tidman, 2011](#)).

### ***The application of symmetry***

To create a topology able to resist the wind load in the leeward and windward directions symmetry constraints were implemented on the design variables of each domain as it is shown in Fig. 10. Two symmetry axes are introduced in the 2D domain PT to ensure enough material distribution to the bottom section where high overturning moments take place.



*Fig. 10.* Symmetry planes introduced on each domain.

### ***Investigating the application of symmetry***

As with the previous section, the application of symmetry constraint was initially investigated on domain FT with the characteristics of analysis C available in Table 2. The main characteristics and the outcome of the analysis are outlined in Figs. 11 and 12.

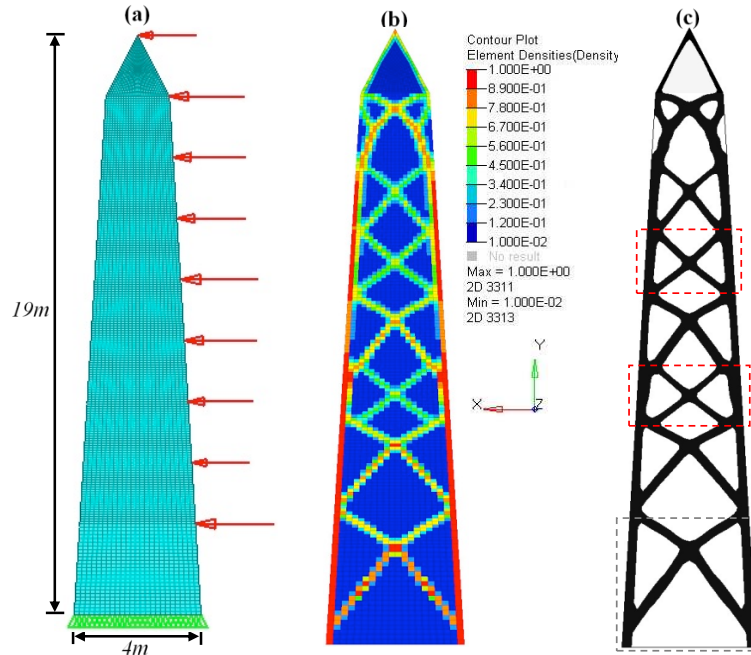

Fig. 11. Fully-tapered face optimisation: (a) loading scenario (b) element-density plot (c) 2D rendering plot.

Symmetry on the y-axis resulted a truss-like topology consisting of various X bracing arrangements. The bracing centreline is determined by the axis of symmetry. The angles observed on the first ‘high-waisted’ panel of the topology available in Fig. 11 and 12 are in agreement with the angles of the first panel on the bracing geometry presented by [Stromberg et al. \(2012\)](#) for high-rise building applications. In addition, the height to the centre of the bracing ( $0.7H_p$ ) found in the present study is almost the same as height  $z=0.75H$  indicated in [Stromberg et al. \(2012\)](#). The difference between the two ratios emerges from the inclined columns in the domain FT, despite the straight columns (vertical chords) arrangement provided by [Stromberg et al. \(2012\)](#).

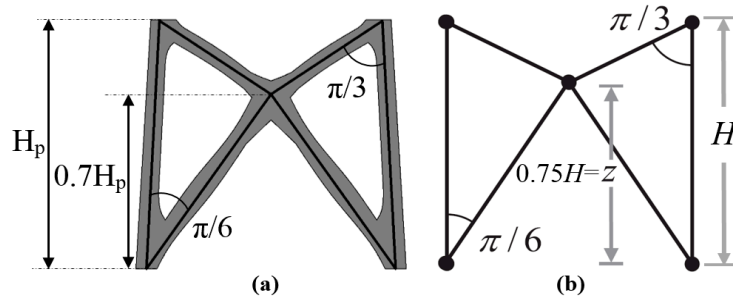

Fig. 12. (a) High-waisted bracing obtained (b) optimum bracing geometry [15].

In addition, various X bracing arrangements indicated that different types of mechanisms may possibly take place within a single domain during optimisation. For instance, while the first panel indicates a ‘cantilever problem’ caused by the coupling effect of moment and shear, the panels enclosed by the vertical chords (red lines) in Fig. 11 demonstrate a shear effect ([Stromberg et al., 2012](#)).

The ‘shear problem’ is caused due to the stresses generated by the wind forces entering the domain horizontally and the axial forces flowing towards the foundations at the two edges (Fig. 13). In addition, according to [Stromberg et al. \(2012\)](#), the optimal angles arising out of

shear problems should be around  $45^\circ$ . The angle observed in Fig. 13 is  $42^\circ$ ; the difference can be justified due to the inclined columns.

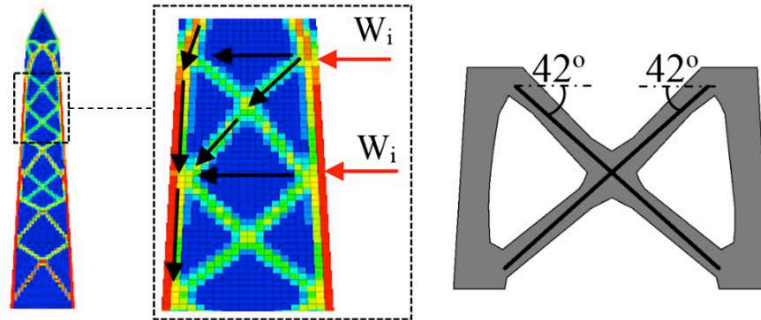

Fig. 13. Bracing pattern due to shear type problem generated within the domain.

Slender structures are mainly subjected to wind actions resulting in a combined effect of overturning moments and horizontal shear closer to the base of the domain. These are more suitably resisted by a ‘cantilever problem’ bracing according to [Stromberg et al. \(2010\)](#). Therefore, the third panel located closer to the bottom of the structure is not ideal as it represents a ‘shear problem’ topology rather than a more desirable cantilever bracing.

In order to improve the resulting topology, the loading scenario is changed to a higher magnitude distributed load. Both strategies were employed to ensure high bending and shear will occur closer to the bottom of the tower and mainly horizontal shear closer to the top. The domains are forced to produce optimised desired topologies comprising of cantilever and shear bracings formed closer to the bottom and top, respectively, or just cantilever bracing throughout.

### 3.2 Optimisation study of 2D domain

Following the implementation of symmetries, determination of the adequate elements’ thickness, and suitable volume fraction, the final results for the 2D domains are presented and discussed within this section. The characteristics of each OA are presented in Table 3. In general, the analysis of domain PT required more iterations to determine the optimal distribution of material. This is mainly due to the two symmetry axes used for its analysis.

Table 3. Characteristics of the optimisation analyses performed on the 2D domains.

Domain	Boundary conditions	Iterations number	Elements thickness (mm)	$t_e$ Volume fraction (%)
FT	Full base fixed	59	215	0.25
FS	Full base fixed	52	215	0.25
PT	Full base fixed	74	215	0.25

As it can be observed by the results depicted in Fig. 14, the topology of the domain FT comprises of three consecutive ‘high-waisted’ bracings closer to the bottom of the tower due to the coupling effect of bending and shear actions. This is confirmed by investigating the angles as well as the distance  $z$  of the braces (a), (b), and (c) available on Fig. 15. Both measurements lean towards the angles and  $z$  height of the optimum cantilever bracing illustrated by [Stromberg et al. \(Beghini et al., 2014; Stromberg et al., 2012\)](#). It is worth to note, that the ‘optimum cantilever bracing’ inner top and bottom angles are of  $60^\circ$  and  $30^\circ$

(i.e., forming a right triangle) respectively, while its height  $z$  corresponds to 75% of the panel's height ( $H_p$ ). In addition, the material intensity of the columns is less dense at the top indicating the needs for change in the cross-section size from the bottom to the top of the tower; a concept already applied in the design of conventional lattice telecommunication towers and slender structures.

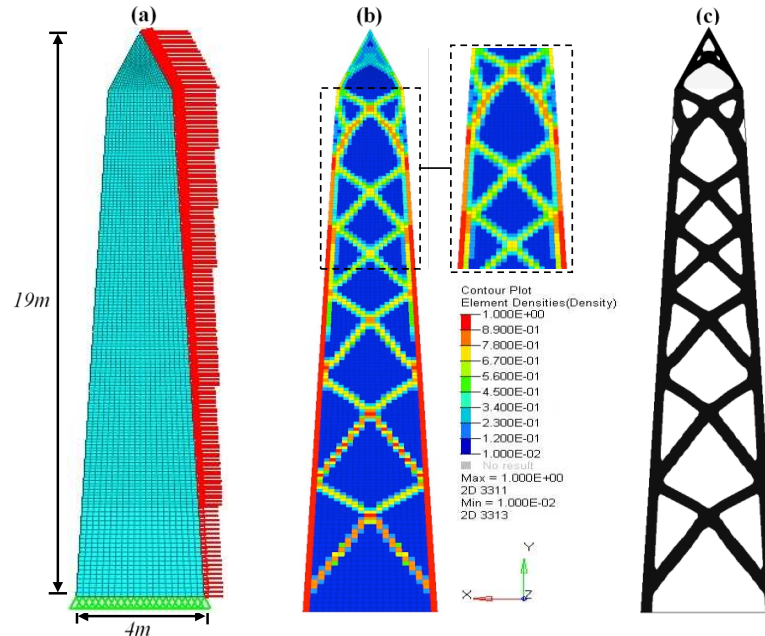

Fig. 14. Fully-tapered face optimisation: (a) loading scenario (b) element-density plot (c) 2D rendering plot.

Although at the top bracing panel (d) a ‘shear problem’ is demonstrated, the angles observed lean towards the optimum angles of a ‘cantilever problem’ bracing. Panels (e) and (f) of Fig. 15 are more complex to interpret due to the intermediate lines. However, height  $z$  indicated that both top panels look more like high-waisted bracings; capable in resisting shear and bending actions. Consequently, the optimisation analysis results of the fully-tapered domain indicated the use of high-waisted braces throughout the full height of the structure. It is also noticed that as the height of the tapered tower increased, the distance ‘ $z$ ’ of each panel decreased (except for panel (f)).

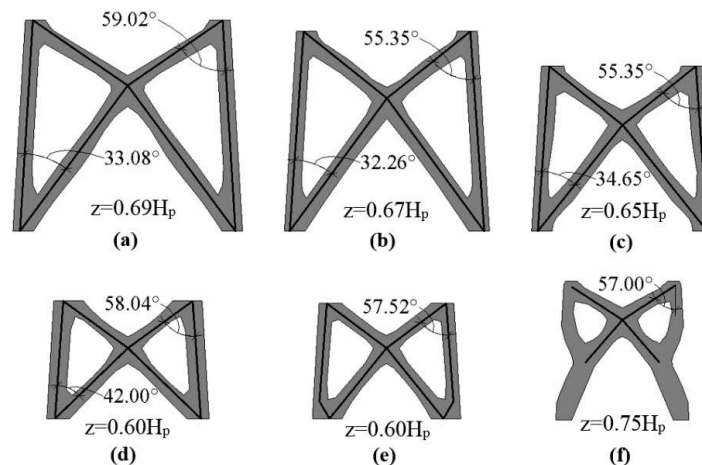

Fig. 15. Interpretation of the optimised topology on the domain FT.



The optimisation of the domain FS as shown in Fig. 16 resulted X bracing systems arrangement throughout the entire height of the tower. The resulting topology consisted of four bracing panels in total where (a) and (b) are high-waisted bracings. In addition, the X bracing of type (c) (Fig. 17) seems to compose a system which represents the topology of a ‘shear problem’. This is based on the fact that the top angle of  $50.92^\circ$  approaches the optimal angle resulting from a shear problem (i.e., the angles must be equal to  $45^\circ$ ).

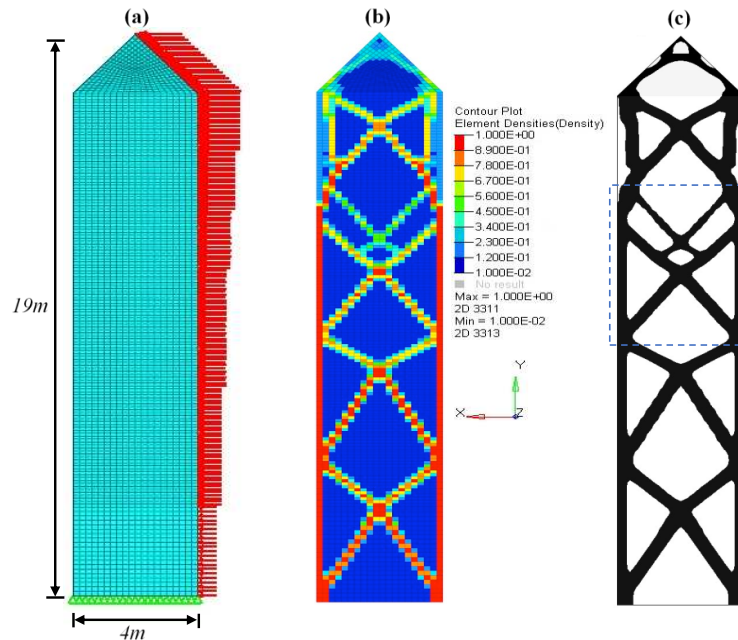

Fig. 16. Fully-straight face optimisation: (a) loading scenario (b) element-density plot (c) 2D rendering plot.

The additional smaller bracing system formed at the top of bracing (c) was possibly the best way to increase the stiffness of the resulting topology using the available material volume, thus satisfies the weighted compliance objective function. The angles observed to the final X bracing type (d) indicated a cantilever problem topology system. It is worth noting that only four panels compose the whole system, with OptiStruct significantly reduced the number of structural elements required for this structure.

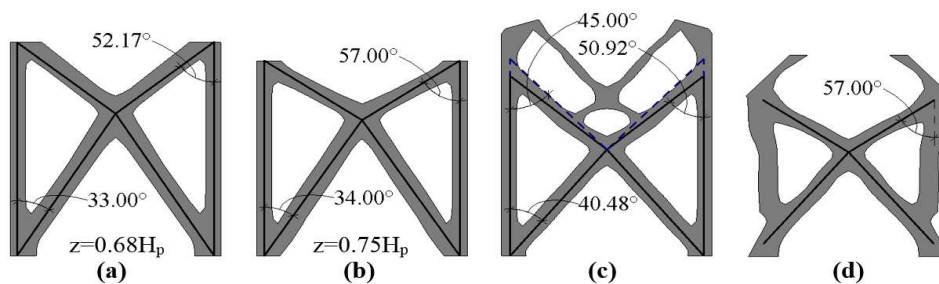

Fig. 17. Interpretation of the optimised topology on the domain FS.

Optimising domain PT available in Fig. 18, it is observed that the bracing pattern produced above the tapered section is irregular. High-waisted and optimal shear bracings are not found at the expected locations. This is because of the current location of the horizontal axis of symmetry.

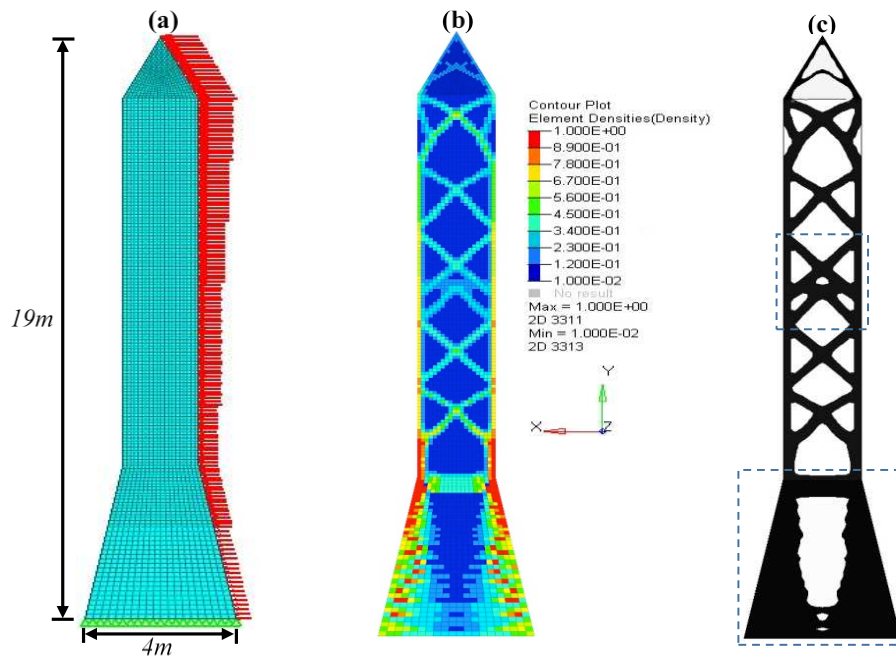

Fig. 18. Partially-tapered face optimisation: (a) loading scenario (b) element-density plot (c) 2D rendering plot.

From the analysis of the PT domain, it should be highlighted that symmetry constraints are used to obtain symmetrical distribution of material rather than geometries.

### 3.3 Optimisation study of 3D domain

The resulting optimised 3D topology clearly demonstrated that the solution is heavily dependent on the location of the supports and the direction of the applied forces. Unlike the 2D domain analyses, although axes of symmetry were used in two directions, the topology generated is only able to resist the loading scenario (Fig. 19).

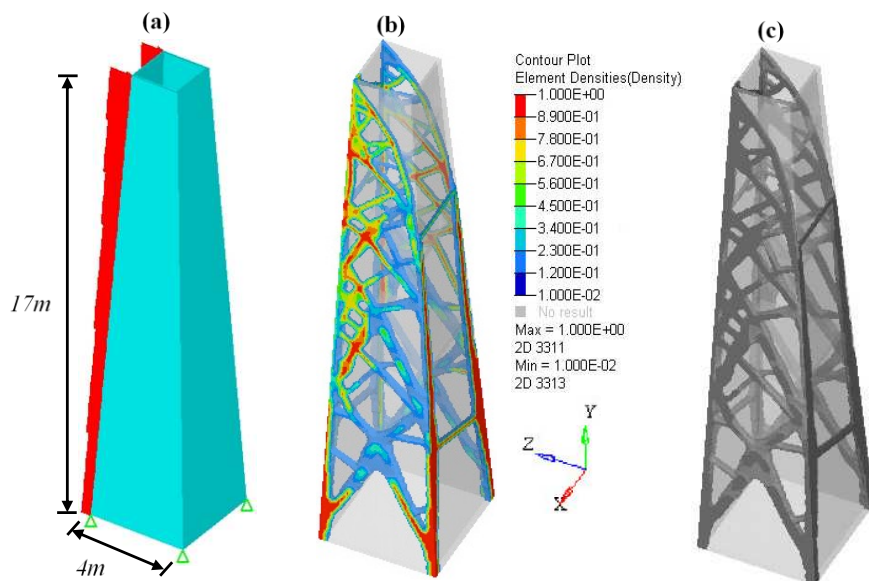

Fig. 19. Fully-tapered optimised tower: (a) loading scenario (b) element-density plot (c) 3D rendering plot.

The optimised 3D layout can be further improved by introducing wind loads in the perpendicular direction and altering different parameters such as the penalty factor and volume fraction. The process should be repeated to test all four directions of wind loading.

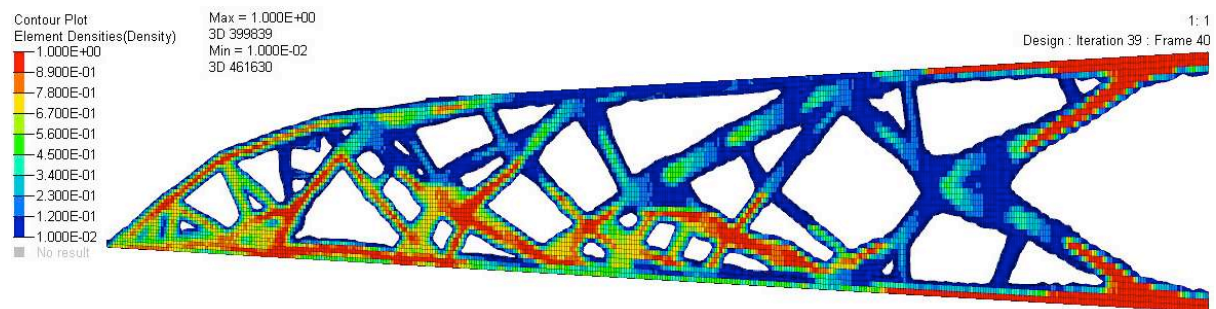

Fig. 20. 3D optimisation layout in elevation.

As with the 2D analyses, to resist the lateral forces and to tie the legs of the skeleton, material is distributed from left to right and right to left, respectively. From Figs. 19 and 20, it is also observed that higher material density occurs on the tension side of the tower (i.e., the side where the load is acting). The first panel comprised a high-waisted bracing while the entire the proposed cross-section sizes are varied.

### 3.4 Optimisation remarks

The best topology obtained from the 2D domain FT, thus this design is further examined. It is evident that the material distribution is heavily dependent on stress trajectories generated within the domain in accordance to the loading scenario and support conditions. The optimisation techniques used indicated a reasonable and consistent conceptual layout and a detailed parametric optimisation study is further required for developing consistent optimal layouts.

Other important outcomes in relation to the optimisation studies performed on FT domains include the decrease in height  $z$  with the increase of the domain's height. Values of  $z$  ranged from  $0.60H_p$  to  $0.75H_p$ . Observing bracing panels (a), (b) and (c) of this domain, it can be argued that 20% reduction of the top width in relation to the bottom width of each panel results in 2% reduction of the height  $z$ . On the same basis, standard design equations 1 and 2 for the determination of the height  $z$  on fully-tapered towers can be developed. This can be related to the percentage ( $p_i$ ) reduction in the top width ( $w_{i+1}$ ) of each panel which is relative to the base width ( $w_i$ ) of the tower and the value of  $z$  related to the increase of percentage  $p_i$ . Therefore, the height  $z$  for each panel of a fully-tapered domain can be determined using the following expressions.

$$\begin{aligned}
 p_1 &= \frac{w_1 - w_2}{w_1} \times 100 & \dots & & z_1 &= \frac{p_1 - 200.9}{2.745} \\
 p_2 &= \frac{w_1 - w_3}{w_1} \times 100 & \dots & & z_2 &= \frac{p_2 - 200.9}{2.745} \\
 & \dots & & & & \dots \\
 \text{Eq. (1) } p_i &= \frac{w_1 - w_{i+1}}{w_1} \times 100 & \dots & \text{Eq. (2) } z_i &= \frac{p_i - 200.9}{2.745}
 \end{aligned}$$

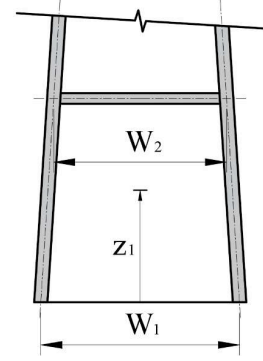

Through the analysis of the PT domain, it is observed that the optimal solution may be the combination of optimal layouts resulting from different analyses. Angles of high-waisted bracings observed in the analyses of FT and FS domains are similar to the optimum angles of high-waisted bracings demonstrated in the literature (Beghini et al., 2014; Stromberg et al., 2012).

It is also concluded that the number of individual structural components for a single tower's face is significantly lower on the optimum layouts in comparison to this of model UA. Consequently, the optimised tower will be significantly lighter and become less visually intrusive than the conventional structures.

It is worth noting that the application of manufacturing constraints enabled this study to create a symmetrical tower. This is achieved by introducing a manufacturing constraint and other specific symmetry constraints with planes being placed as indicated in Fig. 10. The key characteristic of the final topologies observed are the high-waisted type bracing panels.

#### 4 MORPHOGENESIS PROCESS AND STRUCTURAL PERFORMANCE

A morphogenesis process took place by post-processing the optimised morphologies. Consequently, the performance of the optimum design can be evaluated, comparing it against the original tower design located in Greece (also designed to resist seismic actions).

Post-processing includes the generation of iso-density surface using OSSmooth (a post-processing tool from HyperWorks suite by Altair 2012, 2015), manual drawing intermediate lines and replication of the lines belonging to a single surface into four tower faces for the production of the 3D CAD model (Fig. 21).

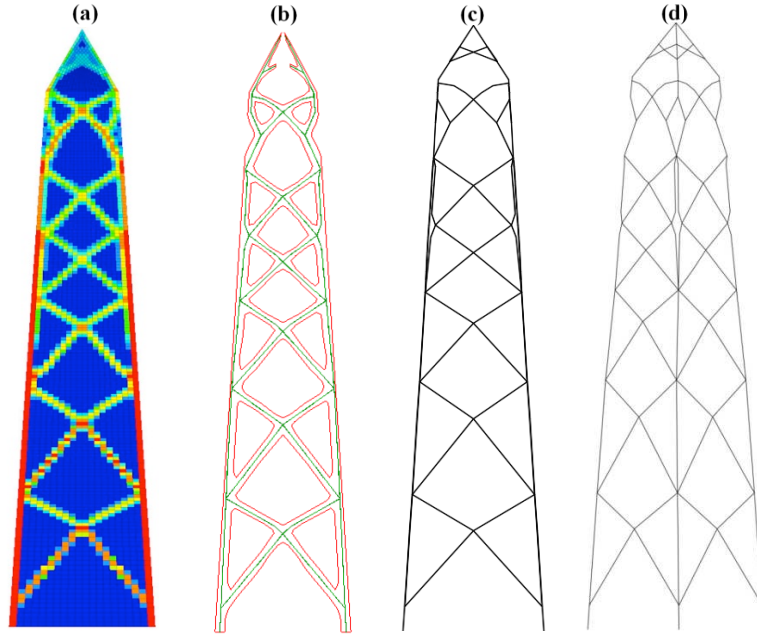

Fig. 21. Morphogenesis process: (a) 2D fully-tapered element-density plot, (b) iso-density surface and capture of the nerves with intermediate lines, (c) elevation, and (d) 3D lines exoskeleton drawing.

Model file of FT and UA towers were transferred from AutoCAD to structural software package Oasys GSA and both were assigned with steel structural members (Fig. 24). Modal analyses were performed to identify the natural dynamic characteristics of each 3D specimen composed of 1D beam elements. In order to evaluate the performance of the optimised model, the dynamic characteristics obtained for each specimen were compared against each other. At this stage, the study was focused on the first two bending and one torsional vibration modes.

#### 4.1 Models geometry

Both FE models have the same total height of 19m and similar base grid dimensions. The basic geometric characteristics of each model are summarised in the Table 4.

Table 4. Basic geometrical characteristics of the towers (all dimensions in m).

Model	Taper height $H_t$	Cap height $H_c$	Total height $H$	Base grid $W^*$	Cap width $W_c$
UA	5	2	19	4	2
OT	17	2	19	3.7	1.82

\*Both specimens have square footprint.

The height of each optimised panel is available in Table 5 in the form of parametric equations. Following that, each panel is assigned with a notation which is related to Fig. 22. Similarly, parametric equations for the width at the top of each panel were also established. From Fig. 22, it can be observed that the standard tower comprises of 9 panels whereas, the optimised telecommunication tower comprises of only 7.

Table 5. Panels' height in parametric equation form.

Model	Panel	Panel height	Width at top of the panel
UA	A	$0.105H$	$0.500W$

	B	$0.158H$	$0.696W$
	A	$0.108H$	0
	B	$0.121H$	$0.496W$
	C	$0.110H$	$0.601W$
OT	A	$0.108H$	$0.540W$
	D	$0.146H$	$0.688W$
	E	$0.182H$	$0.817W$
	E	$0.182H$	$0.907W$

The number of structural elements is drastically reduced in the optimised topology which implied reduced number of connections and maintenance requirements for members and connections, provided that such members do not fail in buckling. Also, the solidity and surface area of the optimised tower in the windward and leeward directions is also drastically reduced depending on the type of structural elements that are employed. In this project, elliptical hollow sections (EHS) were selected for the model OT while the standard tower morphology of model UA made uses the typical right angle sections (RAS).

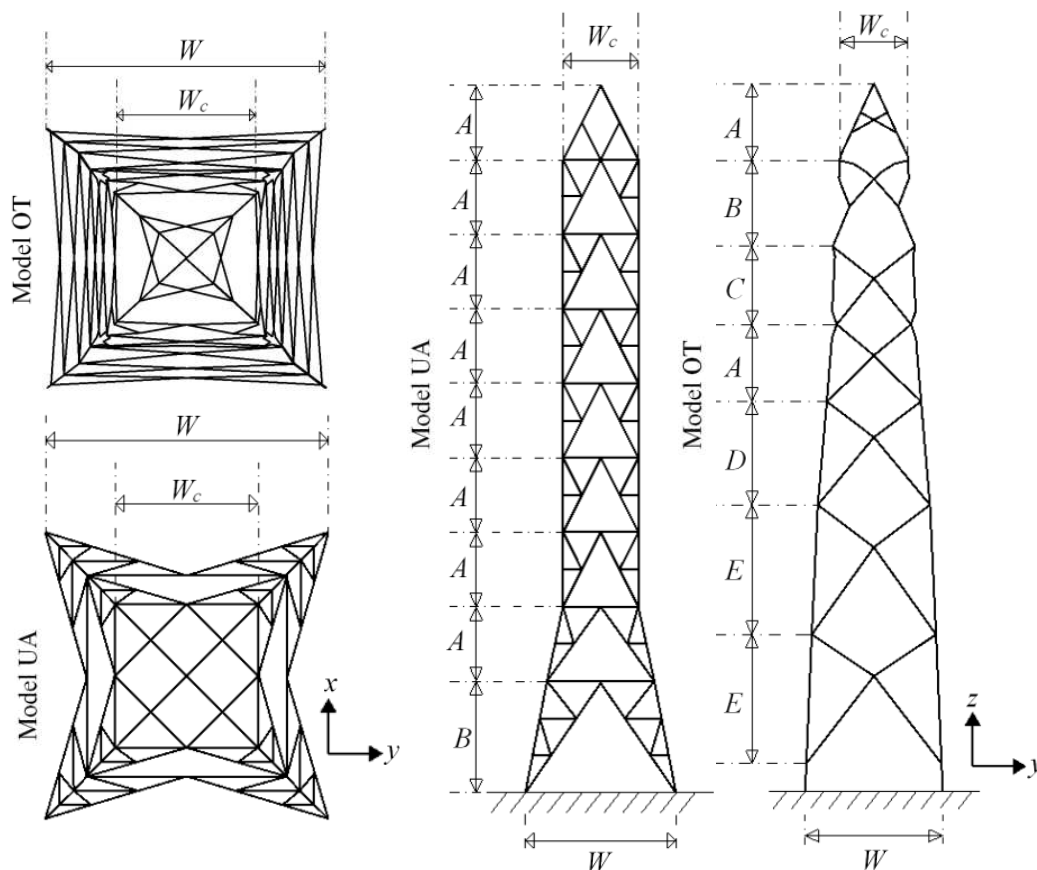

Fig. 22. General towers' configuration in plan and elevation.

## 4.2 Structural sections

The section sizes for model UA were provided by the initial design of the tower (data provided by the Department of Civil Engineering at Aristotle University of Thessaloniki,

Greece) whereas the section sizes for model OT were designed according to EC3 (Eurocode 3, 1993). The basic characteristics of the sections assigned to each model are illustrated in Table 6 and schematically presented in Fig. 23. In addition, it should be noted that the standard tower possesses secondary and primary bracing members. On the other hand, the optimised tower is comprised by only of primary bracing members.

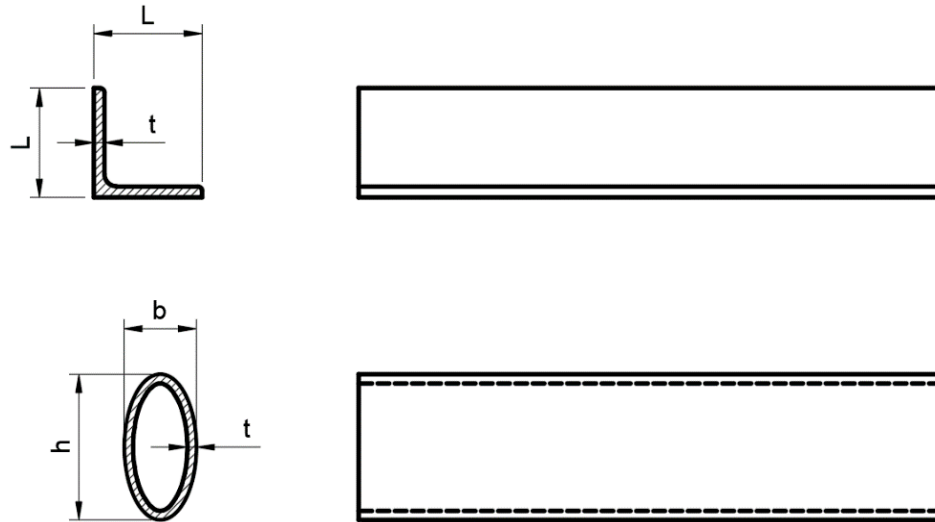

Fig. 23. Geometrical characteristics of typical RAS and EHS.

Table 6. Sections adopted on each tower model.

Model UA				
Segment(m)	Columns	Primary members	bracingSecondary members	bracing
0 - 5	120 × 120 × 12	60 × 60 × 6	60 × 60 × 6	
5 - 11	110 × 110 × 10	60 × 60 × 6	60 × 60 × 6	
11 - 19	70 × 70 × 7	60 × 60 × 6	60 × 60 × 6	
Model OT				
Segment(m)	Columns	Primary bracing members		
0-19	150 × 75 × 5	80 × 40 × 5		

RAS section: Length (L) × Length (L) × Thickness (t) – All dimensions in millimetres.

EHS section: Height (h) × Breadth (b) × Thickness (t) – All dimensions in millimetres.

### 4.3 GSA models

The 3D CAD models were imported to Oasys GSA as shown in Fig. 24. The scope was to understand how the new tower performs and to improve its design. At this stage no horizontal bracing was introduced between the exterior skeleton phases. This particularly affected the tower's performance in torsional mode of vibration. Intermediate horizontal bracings were removed from the original tower UA to undertake a fair comparison between the two models according to Albermani et al. (2004).

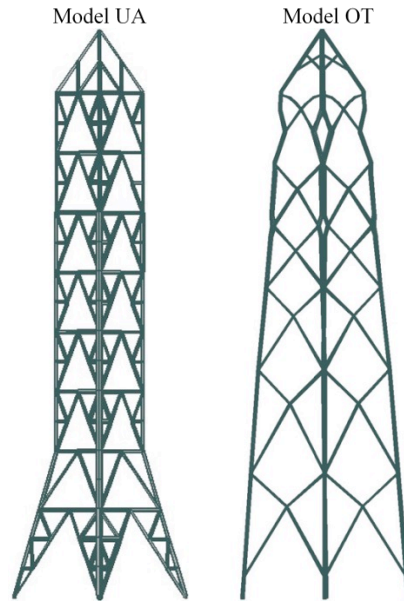

Fig. 24. Oasys GSA FEM.

Both specimens were assumed to be fixed on the ground and hence, all degrees of freedom at the end of each column are restrained avoiding any unstable movements. Some degree of flexibility may be offered dependent on the soil properties, however, in this case their effect is neglected. Overall, the change in form conspires in making a relatively lighter structure, thus propounding a lighter design of foundation; showing a potential of achieving economic viability.

#### 4.4 Natural frequencies and modes of vibration

Natural frequencies and vibration modes of the towers are key characteristics for the design of such slender and lightweight structures. During vibration, structural members can be jeopardised, accumulate fatigue damage and/or fail in buckling (Oliveira et al., 2007). Through modal analysis the natural frequencies and modes of vibration are determined by using the equation of motion for free vibrating undamped systems. Table 7 summarises the modal characteristics obtained for the two bending and torsional mode of the towers.

Table 7. Modal characteristics obtained by Oasys GSA.

Specimen UA				Specimen OT			
Mode $i$	Frequency $f_i$ (Hz)	Mass $m_i$ (kg)	Stiffness $k_i$ (N/m)	Mode $i$	Frequency $f_i$ (Hz)	Mass $m_i$ (kg)	Stiffness $k_i$ (N/m)
1 <sup>x</sup>	7.123	522.7	1.047E+6	1	7.411	891.2	1.933E+6
2 <sup>y</sup>	7.142	522.7	1.053E+6	2	7.519	737.7	1.646E+6
4	14.54	964.1	8.046E+6	6	14.42	1158	9.501E+6

<sup>x,y</sup> Bending about the x-x and y-y axes.

Modal analyses demonstrated slightly higher frequencies in both bending modes for the OT model. This means that excitation of model OT can take place in exerted dynamic forces (i.e., due to wind or earthquake loads) with higher frequencies. The percentage of difference in frequencies are ~4% and ~5% for the first and second bending mode, respectively.



The fourth and sixth modes observed are the torsional ones, for models UA and OT, respectively. Model UA demonstrated a slightly higher frequency than model OT in the torsional mode with a percentage of difference at only ~0.8%. The increased frequency observed in model UA is a result of the horizontal secondary bracing members, which highly contributed in improving the behaviour of the tower in the torsional mode.

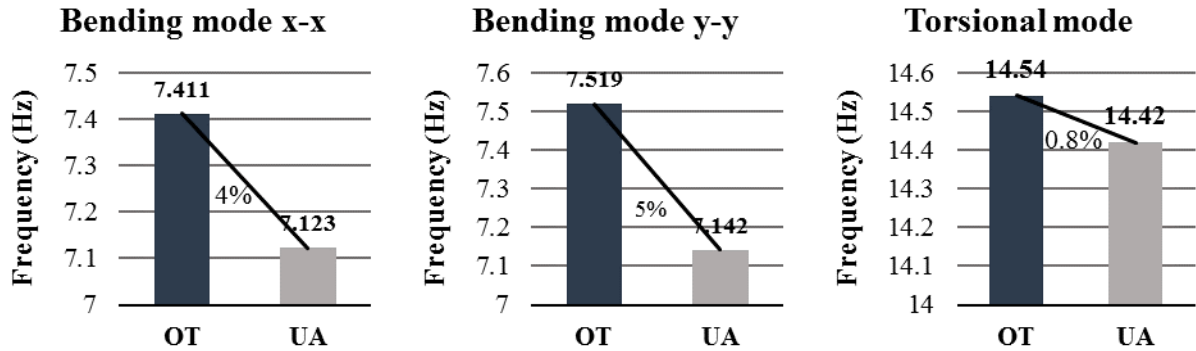

Fig. 25. Natural frequencies comparison of the two specimens.

It is observed that the mass being mobilised for each mode is higher for the optimised model. Similarly, the optimised model indicates high stiffness as a result of its material and geometrical (i.e., topological arrangement of members and incorporation of EHS) characteristics. Therefore, based on the equations  $\omega_n^2 = k_i/m_i$  and  $f_i = \omega_n/2\pi$  (i.e., undamped free vibrating system), the high frequencies observed on the two bending modes for model OT are a result of its high stiffness. It is worth to note that the percentage of difference in the modal stiffness's of the torsional, the first, and second bending modes are ~15%, ~46% and ~36%, respectively.

Moreover, the frequencies determined for the two bending modes for model UA are almost identical; the ~0.3% error is justified due to modelling errors. For model OT, the difference in stiffness between the two bending modes is ~15%. This is a result of the EHS columns orientation, which are stiffer about the  $x-x$  axis.

The mode shapes of vibration for the first and second bending mode for both towers are depicted in Fig. 26.

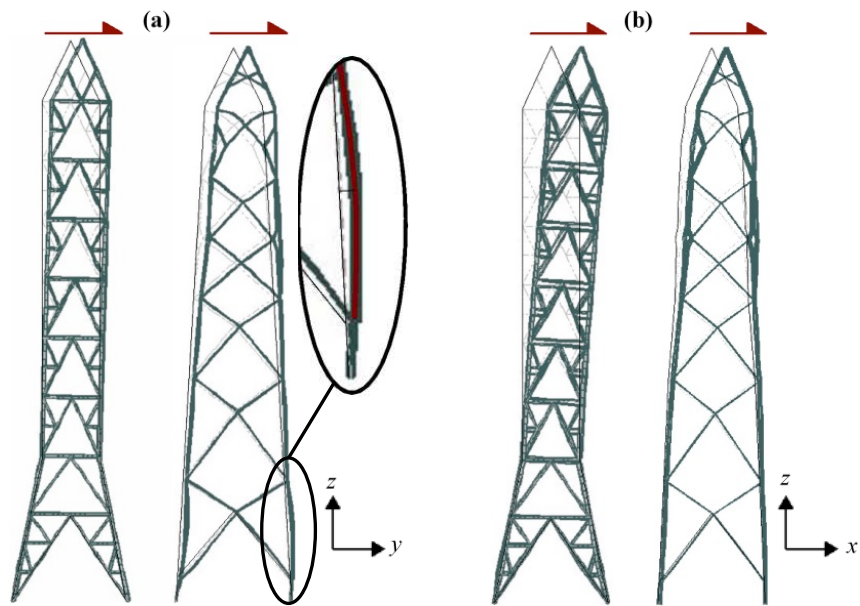

Fig. 26. (a) Bending mode 1 and (b) bending mode 2.

Overall, model OT exhibits a satisfactory behaviour. Nevertheless, buckling of the columns located in the first panel has been observed during bending mode 1. This can be due to the reduced flexural rigidity of the EHS in that direction (i.e., tower is bending in the weak direction of the vertical legs). Consequently, a member with reduced slenderness ratio would be more suitable, while the use of EHS may not be ideal for such structures, although there are other benefits (e.g., aerodynamic shape to reduced wind drag forces, fewer iced surfaces which can effectively change the cross-sectional shape). It should be noted that similar behaviours are observed in the study of [Albermani et al. \(2006\)](#). This study eliminated poor buckling behaviour of columns and bending of bracings by introducing diaphragms into the system.

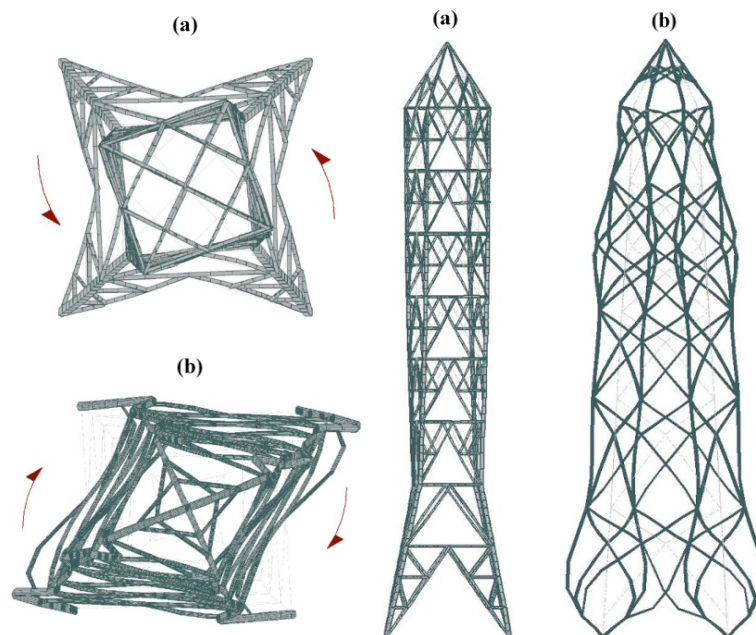

Fig. 27. Torsional mode on plan and elevation (a) specimen UA and (b) specimen OT.

In the torsional mode, it is observed that the shape of model OT is highly distorted in comparison to the shape of model UA. This implies that the optimised tower, despite its aforementioned benefits and its satisfactory static performance, it ideally requires horizontal

bracing members (Albermani et al., 2006) to avoid member buckling and distortion, especially at lower levels. This phenomenon highlights the appropriateness of the initial optimised results (for example as shown in Fig. 18) which clearly demonstrated the need for more material at the lower level of the optimised domain. Yet, the optimised model illustrates that with such reduced material, a different optimised form of exoskeleton can create a new alternative and feasible design.

## 5 CODIFIED DESIGN AND EFFECT OF CROSS-SECTIONS

An aesthetically pleasing and structurally improved novel lattice telecommunication tower is developed through the application of STO. The new topology comprises contemporary and intriguing design characteristics. The modal analyses undertaken using Oasys GSA demonstrated positive findings and signified the importance of further investigation towards a lightweight and safe but efficient design.

To summarised, both examined towers have the same height and base width. Fig. 22 shows the profiles in elevation for tower model UA and OT. Tower UA is constructed using Right-Angle Section (RAS). It consists of four different types of sections, using a single bracing section and three different column sections in the entire model.

Elliptical Hollow Sections (EHS) form the exoskeleton for model OT. Model OT comprises of two different sections, EHS 150x75x4 and EHS 80x40x5; one each for column and bracing, respectively. Specific significant changes are made during the design of model OT. Circular Hollow Sections (CHS) are chosen over Elliptical Hollow Sections (EHS) owing to the limitation of the analytical tool used. The profile elevation derived by the morphology of the tower remains unchanged.

Given the profiles, minor modifications are made in the exoskeleton form of the towers before beginning the performance analysis of the models. Briefly unfolding, the proposed optimised tower had geometrical asymmetries which generated errors in Eigen frequencies. The research process describes the measures taken to mitigate them using a scientific and heuristic approach.

EHS has distinct primary axes, denoting different load-carrying capacity on each of the axes. Using them appropriately would result in an efficient design, for an asymmetrically loaded structure. Carefully observing the plan of the proposed optimised model OT (Fig. 22), it is evident that the (post-modification) exoskeleton looks reasonably regular in the plan. The loads acting on every member would be distributed symmetrically. Also, as shown in the section details of the existing tower UA (Fig. 31), equal (leg) angle sections are adopted in the design. The designer has made attempts to avoid any asymmetries or irregularities in the design, making the design relatively simple.

Correspondingly, from a buildability point of view, the assembly and erection shall be made with immense precision, particularly in maintaining the orientation to obtain integrity. Equivalent Circular Hollow Sections (CHS) are used to side-step these matters. Notably, the sections were chosen considering the capacity on the minor axis, taking a conservative approach.

### 5.1 Morphology process

The existing tower, model UA, has a partially tapered form, with the column member sections changing at three different heights (Fig. 28). Symmetries are maintained on both the axes in the plan area, making it simple for the designer in estimating and assigning the possible loads acting on the tower structure. Angle sections are used in the entire model. The profile is considerably simple, where the first bay is 3m in height, followed by 8 bays of 2m height each. This is owing to the bracings that are equally spaced. There are a total of 428 members altogether comprising of columns and bracings at varying levels. The column sections change at three different heights, while the bracing member sections remain the same in the entire model.

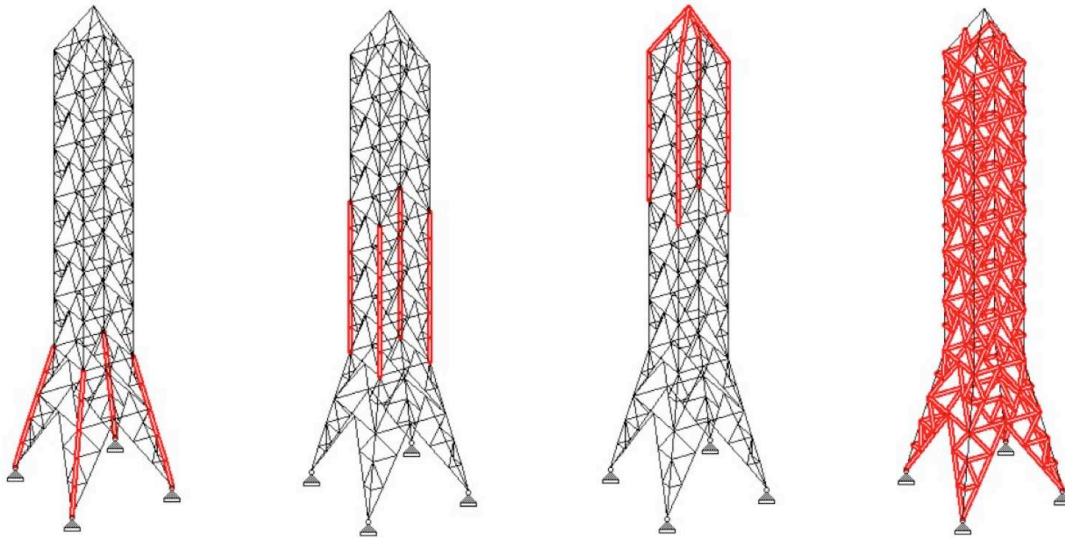

Fig. 28. Sections groups considered in Model UA.

The optimised tower, model OT, has a relatively tapering form, with column and bracing lengths reducing progressively at every bay, starting from the bottom to the top. A mathematical solution is given for determining the height of bays with respect to the specified height of tower as shown in Fig. 29. This solution is a combination of both morphological form-finding by mass extraction method (Nicolaou et al., 2018) and application of Stromberg's optimum angle (Stromberg et al., 2012). There are changes made in the novel model formed after the morphological study; forming symmetries in the plan area of the tower. This is to introduce simplicity for the designers while performing detailed design of the tower. A total of 168 members are assigned along the stress curves formed during morphological study, suggesting minimum number of members in forming an optimised model that is of the same height as that of model UA. This springs an initial observation that the optimal solution is achieved by using members that are about 2.5 times less in number than the existing model UA. As mass is directly proportional to the number of members used, model OT shows a potential of reduction in the total mass of the tower, which is one of the key aspects of bare and lightweight structures. This reduction in mass would also demand for relatively lighter foundations.

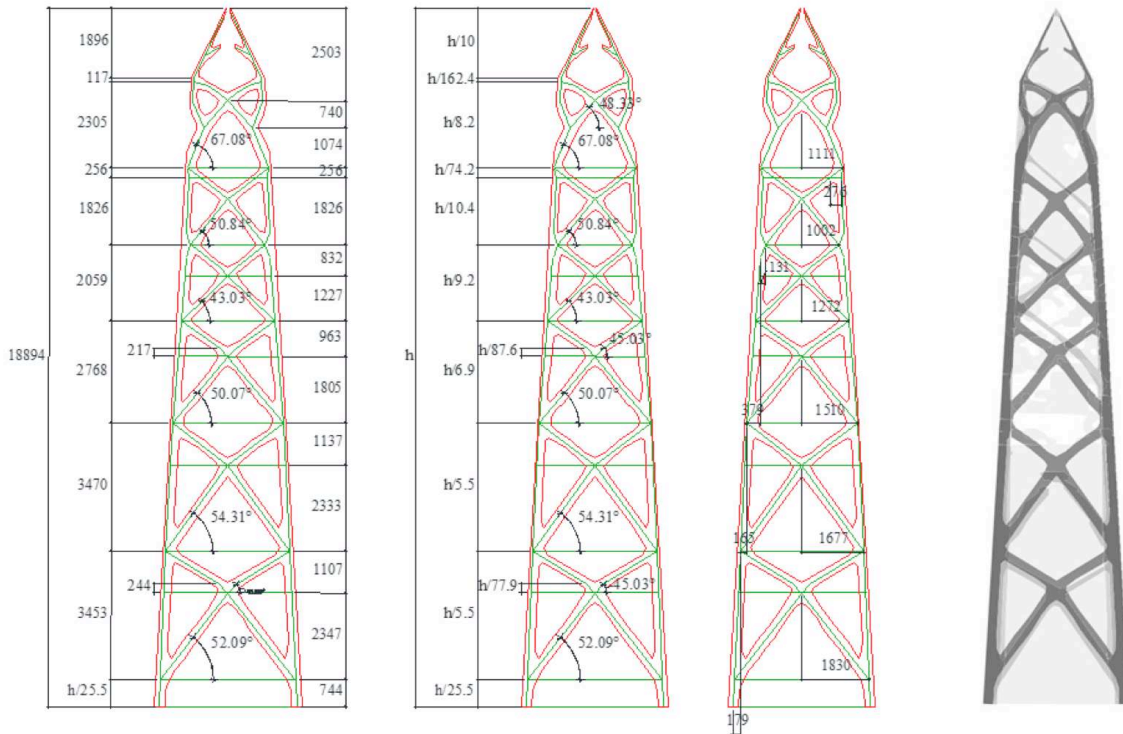

Fig. 29. Form-finding of tower Model OT.

Unlike model UA, the column member sections in model OT are changing at two different heights. Sections for bracing members are kept the same in the entire model as shown in Fig. 30. The optimised models are further put to the test against structural parameters like natural frequency, mass participation, maximum displacement, and most importantly reduction in total mass due to relatively smaller number of members. Moreover, its highly improved aesthetic appearance could be an addition to the design appreciation.

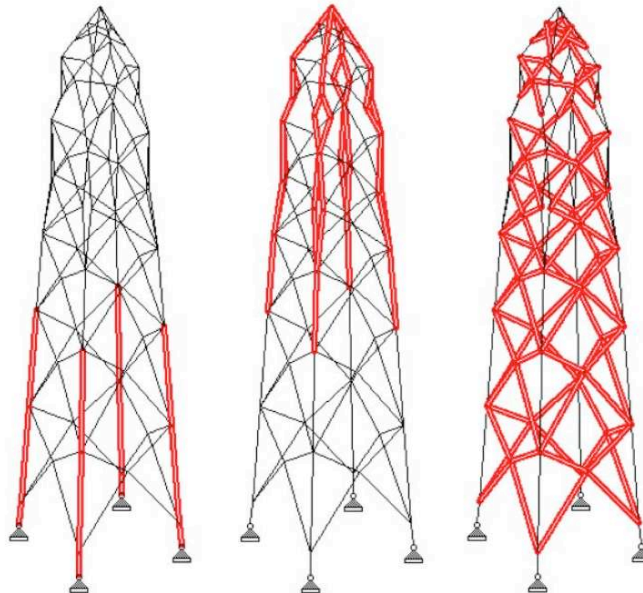

Fig. 30. Section groups considered in Model OT.

## 5.2 Performance-based design

The research-led design was initiated by taking the originally optimised model as a basis, as it was formed by morphology process following a mathematical approach. Modifications are made to mitigate some minor errors encountered while studying the form. One of them are errors in Eigen frequencies. The morphologically optimised model has different Eigen modes along the mutually perpendicular horizontal axes. This is due to the asymmetrical distribution of members in the plan area. Briefly describing, an Eigen mode is a shape formed when the structure deforms while vibrating at a certain Eigen frequency (natural frequency). The deformation is corresponding to the Eigen frequency, which helps in determining the mode shape, but not the amplitude of any physical vibration. The true size of deformation can only be determined if an actual excitation is known together with damping properties and section modulus. Having different Eigen modes along the mutually perpendicular axes makes the design process meticulous. In order to make a simplification in the design process, using a scientific approach, symmetries are formed in the (initially optimised) model. A heuristic study was made during this process to come up with a relatively simple exoskeleton for the engineers to design and build this structure.

Another impediment while forming the optimised frame, is the assumption that the foundation is fixed. A steel frame can be designed in two distinct ways; a moment resisting frame, for instance a portal frame, or one made to resist axial forces only, like a truss. Both these methods can be used to make a sound and efficient design. By engineering judgement, the latter approach was chosen in order to make the design process simple and avoid moments in the foundation design. Hence, the base is kept as a pinned support. The members re designed for resisting axial loads only. Such design assumptions not only make the overall design relatively easier, but also potentially a cost-effective solution.

Model OT 1 has three distinct sections, gradually reducing in size while moving to the upper level, indicating changes made in the outer diameter 'D' and thickness 'T'. There is no curb in the selection of these members, where a freedom of choosing any member section is given, provided it is the same type (here CHS) and material in the entire model. They are selected keeping the utility ratio as an objective function which is similar to that of the existing model UA ( $>0.9$ ). This is done to maintain a constant basis to which the models are further compared amongst each other, providing a clearer view for the optimum ones. By means of engineering judgement, total mass of model OT 1 ( $m_1$ ) shall not be more than model UA ( $m$ ) (i.e.,  $m_1 \leq m$ ). This parameter ensures that the structure will be lighter or similar weight to Tower UA. The designer can then select from the following design parameters (natural frequency, maximum displacement at top, and mass participation).

While enduring a similar process, model OT 2 is obtained by taking model OT 1 as a benchmark model. Further developments are made by altering the cross-sectional sizes. For achieving better connections, it is essential that the members are of the same size, so that a same connection detail can be adopted in the entire model. This will ease the design and execution on site. Considering the said requirements, the diameter 'D' is taken as a constant for all the member sections, which by engineering judgement is taken as the maximum diameter 'D<sub>max</sub>' of all the members. This results the increase in the total mass of the structure by a certain amount (i.e.,  $m_2 \geq m_1$ ), but shall be less than the existing model UA (i.e.,  $m_2 \leq m$ ), to suffice and validate the total mass as one of the optimality criterion. To facilitate this, the thickness of all the members shall necessarily not be the same. CHS come in sizes defined according to the outer diameter with varying thickness on the inner side of the section. These considerations assure improved connections by imparting simplicity as the outer diameter would be constant for all the members.

Model OT 1 and Model OT 2 are optimised to form a buildable design that performs better than Model UA in terms of mass reduction. There is yet another parameter that could be introduced, which has a potential to further improve the optimisation; the buildability (or feasibility) factor. The members in model OT 2 have a constant diameter 'Dmax' with varying thicknesses 'T1, T2, and T3'. To ensure improved buildability, it is suggested to use the same section. This is to accelerate the execution process which in return might save time and lessen the requirement of skilled labour. Doing so, the model shows undesirable results. More emphasis on buildability as an objective function leads to the use of same section throughout the model, increasing the total mass of the model considerably. Hence, by engineering judgement, it is recommended to consider same thickness in the entire model for all the column members ( $T_{max} = \text{greater of } T1, T2$ ), which is different than that of the bracing section (T3). Whereas the total mass of model OT 3 definitely increases than the previously optimised models OT 1 ( $m_3 \geq m_1$ ) and OT 2 ( $m_3 \geq m_2$ ), it possesses a high possibility of exceeding the mass than that of the existing tower model UA ( $m_3 \geq m$ ). As this model (model OT 3) has modifications that did not seem to be significant, optimisation in terms of increased natural frequency and better performance by the reduction of the maximum displacement at top could be obtained.

All the above models, namely Model OT 1, Model OT 2 and Model OT 3 along with the existing model UA, are analysed and designed by considering the following five design cases:

**Case 1:** Bare Tower

**Case 2:** Tower + Antennas

**Case 3:** Tower + Antennas + Ice (actual)

**Case 4:** Tower + Antennas + Ice (max)

**Case 5:** Tower + Antennas + Ice (min)

Case 1 is simulating the construction stage, when the bare tower will not be susceptible to any additional (vertical) loads other than its self-weight, imposed and wind loads acting on it. Case 2 is with Antennas installed on the tower. This will result in additional vertical load (self-weight) of the antennas and attraction of additional wind forces. Ice accretion is addressed in Case 3 for the site location Isle of Harris in Scotland which experiences the maximum wind speed around UK. The ice load acting on the tower is considered in two ways (i.e., in conjunction with wind and in absence of wind). It is worth to note that in no circumstances shall both the loads considered together while performing the analysis. They act distinctively and their respective load combinations are formed accordingly. Case 4 and 5 cover the design for maximum and minimum ice accretion in the entire UK, respectively.

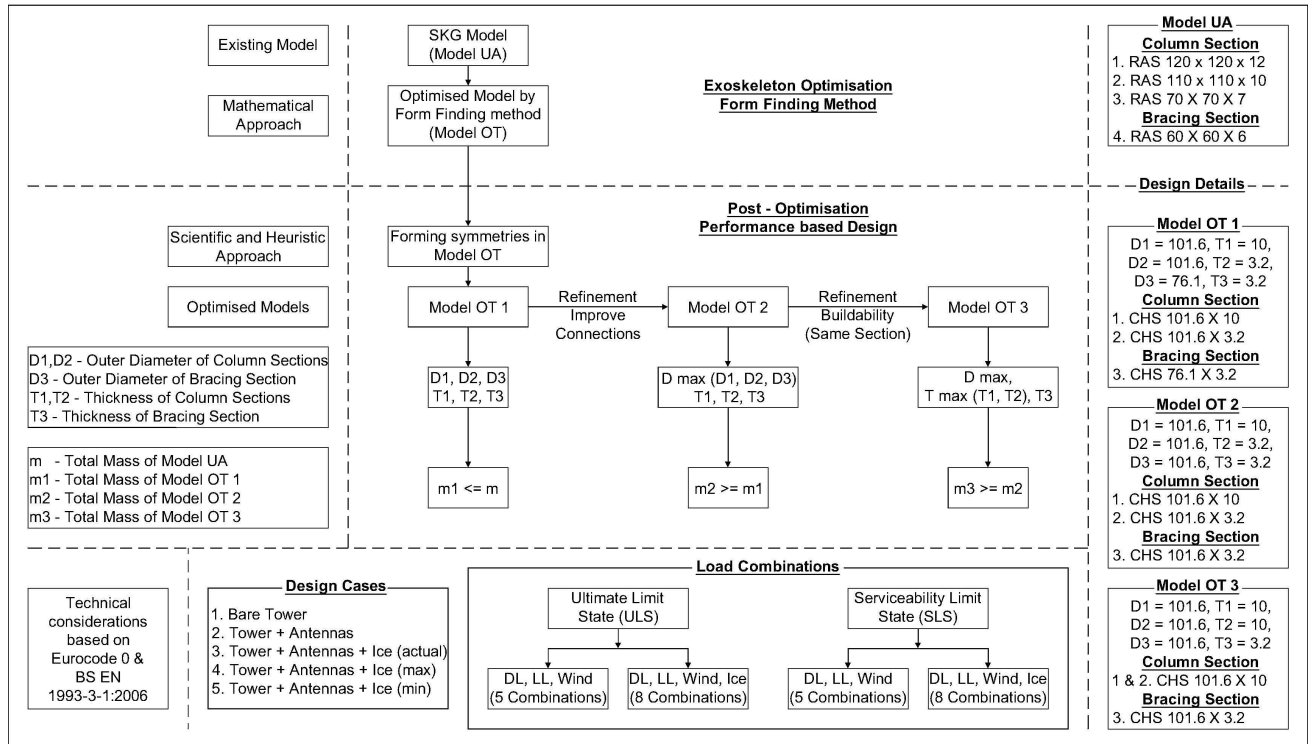

Fig. 31. Research Process Chart

The models are analysed for all the cases for both Ultimate strength (ULS) and Serviceability (SLS) by Limit State method. The total number of load combinations to be formed for all the cases are as shown in Fig. 31. They are pertaining to design codes BS EN 1990:2002+A1 (2005) and BS EN 1993-3-1 (2006). The procedure of obtaining these design details is described in the following section.

### 5.3 Design procedure

The ideal optimum solution would be the one formed by assigning each member at the exact stress level obtained by running a simulation model, enough to cater the maximum forces acting on the structure (and adding a safety factor). Even though doing this seems to be the best solution of all, it is lacking the likelihood of possible practical execution. Here is where the factor of buildability plays a major role in degrading the optimality criterion, enforcing engineers to design, and many times overdesign, the structure using standardised solutions which are easily accessible and executable. This leads to unnecessary use of material even at places where the forces are negligible. Functionality has a similar impact on the design, restricting the engineers to effectively distribute members, for instance having a requirement of large unobstructed spans. Nevertheless, this is a case mostly observed in building designs. In case of bare tower designs, functionality gives liberty to the engineers for overlooking space distribution, increasing the optimisation of the tower.

Tower structures are very slender, thus the lateral force (wind) plays a major role in determining the design loads. The design of towers and masts is normally quite integrated with the analysis, and the optimal design often requires a series of ping-pong between what may be called design and the analysis (Støttrup-Andersen, 2009). It is an iterative process wherein one has to go to-and-fro between design and analysis in order to attain the desired outcome.



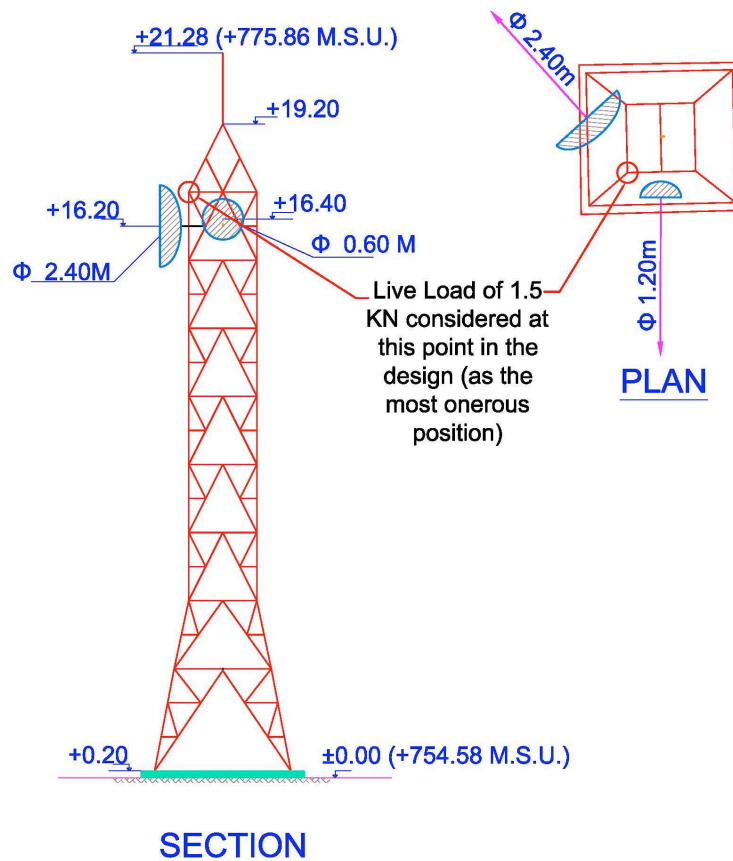

Fig. 32. Existing tower location - plan and section

The real tower is positioned at an elevated base of 20mm above the existing ground level. As shown in Fig. 32 there are two antennas of different sizes, having radius 1.2m and 0.6m, facing different directions on the tower. Looking at the plan and section, the positions of the antennas can be known. Their positioning is fixed and cannot be changed as they are directed towards the satellite that transmits signals to these receivers. Orientation is critical and hence the antennas shall be fixed at the exact height and direction as per the recommendations from the service provider. The live load is considered as 1.5kN. By engineering judgement, this is the most onerous condition, and hence will display the worst condition for which the tower will be designed.

It is worth to note that for such structure, overall drag coefficients are used to calculate the wind forces. Most of the codes present these drag coefficients as functions of the tower solidity. The tower is separated in sections and for each section the force coefficients are determined. The crosswind forces are negligible compared to drag forces. For square towers most of the codes specify only drag coefficients at 0 and 45 of wind incidence angle (the largest force coefficient). Some important parameters, which influence the wind loading, and which are contained in codes of practice related to lattice towers, are the effect of solidity on overall forces; shielding effect; wind incidence angle; and influence of turbulence. This is a long list of variables and it was a major challenge to select a meaningful combination of these for this study. Another important subject is the interference of antenna dishes on the wind forces of lattice towers. It is a common approach to consider the wind forces on antennas independent of the lattice tower, without considering the effects of their presence on the computation of the wind forces. The question arises whether this is a good approach or not according to Celio et al. (2003). To describe the influence of the antenna dishes an

interference factor should be introduced. This factor depends, among other things, on the tower solidity. Parameters involved such as the position of the antenna, type of tower, wind incidence angle, number of antennas and tower solidity are considered in this study.

The influence of parabolic microwave antennas has been considered through the design considerations. [Holmes et al. \(1993\)](#) studied the interference factor of microwave antenna dishes attached to lattice towers with different wind incidence angles, and found values greater than unity for some wind directions ([Celio et al., 2003](#)). The antenna used herein resembles the stems of many plants. Each structure is consisted of simple elements, i.e. rods, beams, plates, etc., which have simple geometrical shapes. Wind force coefficients for individual components have been considered in the design using [BS EN 1993-3-1 \(2006, B.2.3 \(1\)\)](#) – for linear ancillaries. The force coefficients were calculated using [BS EN 1993-3-1 \(2006, Table B.2.1\)](#). Reduction factor for ancillary items ([BS EN 1993-3-1 \(2006, B.2.3 \(3\)\)](#)), although referring to the NA, the reduction factor is equal to 1.0.

[Fig. 33](#) depicts the detailed design process followed herein for all the models. This design process is tailored for the use of CHS and EHS sections; an engineer can use it for other sections by incurring minor modifications while calculating the wind actions. The wind actions are calculated by following the guidelines given in [BS EN 1993-3-1 \(2006\)](#) and [BS EN 1991-1-4 \(2005\)](#), where an engineer can refer them for angle or plate sections, and CHS as well.

[Fig. 33](#) addresses the design of lattice towers with dynamic wind loads assigned in a quasi-static manner. This is to assist the designer in implying consideration of **dynamic wind forces** acting in a static manner without actually undergoing wind tunnel testing or CFD analyses which can be onerous and time expensive and usually the last resource. This improvisation will help the designers to provide a sound design, not only by suggesting a way for consideration of dynamic forces manually, but also making the design process quite coherent.

As it was aforementioned, the design of a tower is an iterative process. Hence, it is essential for the engineer to select the right parameters by engineering judgement so that least efforts could be made in order to come up with a feasible design. The flowchart in [Fig. 33](#) gives the engineers certain ‘intermediate’ results which ensure the omission of unnecessary iterations. This enhances the design process thereby making it simple and comprehensible. A total of 272 analyses were performed pertaining to the load combinations (both ULS and SLS) for all five design cases each for Model UA, Model OT 1, Model OT 2, and Model OT 3 as shown in [Fig. 31](#). They cover all the conditions that are essential to be looked upon according to [BS EN 1990:2002+A1 \(2005\)](#) and [BS EN 1993-3-1 \(2006\)](#).

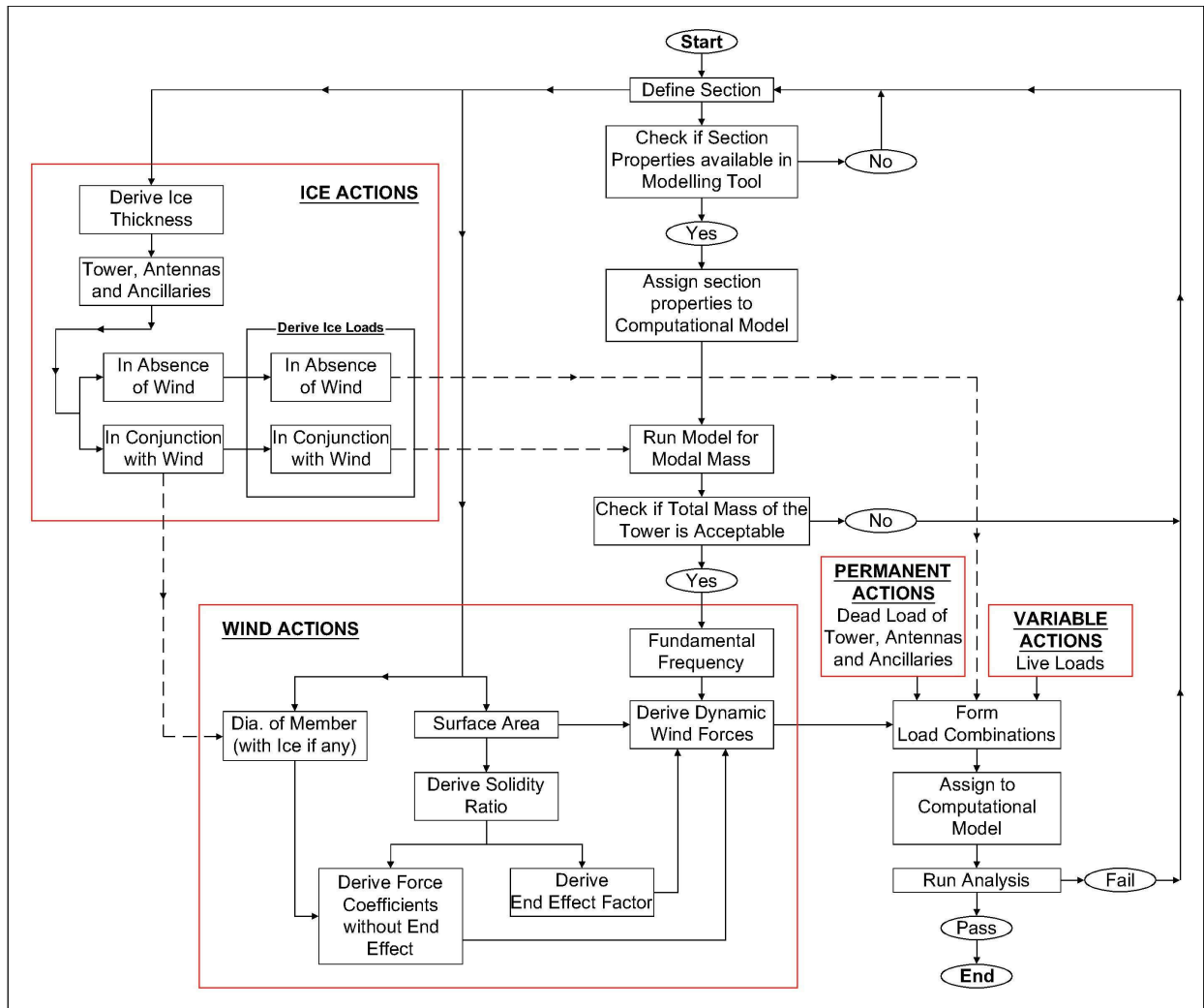

Fig. 33. Design process flowchart.

## 5.4 Results

### Fundamental frequency

Fig. 34 depicts the fundamental frequencies of all tower models. The bar chart clearly indicates the descending trend between individual cases in each model. The fundamental frequency is decreasing gradually from case 1 to case 4, whereas case 5 has the same value as of case 2. For case 5, the minimum ice thickness for the UK is zero. Therefore, the tower conditions of case 5 are exactly the same as of case 2 (bare tower and antennas).

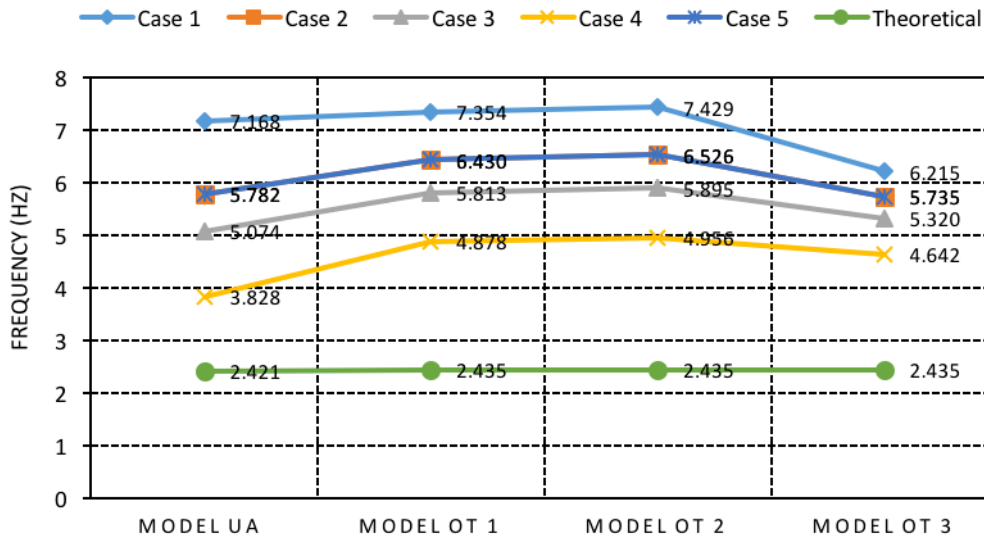

Fig. 34. Fundamental frequencies.

Model UA has the least fundamental frequency in all cases. There is an increase in the frequency in model OT 1, with model OT 2 having the highest values of all. As the fundamental frequency is inversely proportional to the mass assuming a constant stiffness  $K$ , the study suggests that although model OT 1 has an improved system in terms of lesser mass, it is model OT 2 that yields slightly better results than OT 1. Model OT 3 experienced the lowest fundamental frequency, indicating an increase in dynamic force acting on the tower, hence making it undesirable. This explains that although the proposed optimisation research process can provide better solutions, there has to include some intelligence with regards to the effect parameters to be considered in the optimisation process.

A clear difference between the annotative and theoretical values can be observed. The theoretical values derived are less than half the magnitude of frequencies in comparison to the other cases, suggesting a conservative approach to the designer. The values derived from the fundamental frequency (based on  $n_1=46/h$  as per BS EN 1991-1-4 (F.2 (2) Eq. (F.2))) are far lower than the ones obtained by conducting modal analyses. Thus the Eurocode is leading to conservative assumptions that suggest a safe static design. Consequently, a quasi-static approach is chosen herein which not only considers dynamic wind forces, but also makes it simple for engineers to design towers efficiently without undergoing laborious FEA, dynamic analyses, or wind tunnel testing.

#### Total Mass

There is a significant variation in the masses of the tower models considered. Fig. 35 clearly demonstrates the reduction of total mass of the optimised models OT 1 and OT 2 in comparison with model UA, whereas model OT 3 has a relatively larger mass. This shows that the first two phases of the optimisation were effective, where model OT 1 has the least mass.

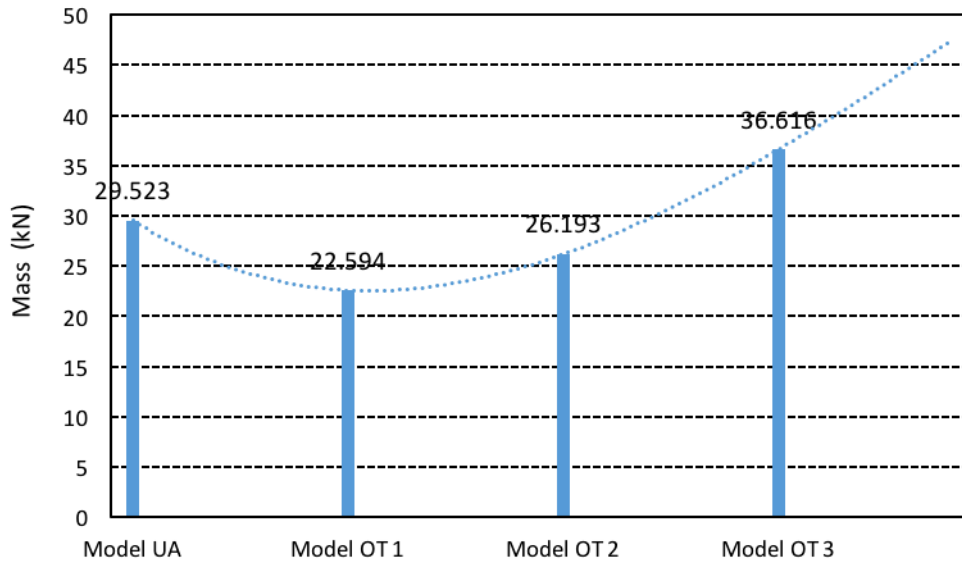

Fig. 35. Total mass.

It is evident that in the efforts to increase the buildability of the tower, there is a high risk of increasing in the total mass of the model (e.g., models OT2 and OT 3). Adding to the advantages, the reduced mass will ensure design of lighter foundations. This leads to reduction in both, the material and thereby the cost of foundation.

#### Utility Ratio

Utility ratios of all member sections are taken with reference to that of model UA. Most of the members of model UA have been designed at a ratio above 0.9, only the uppermost column sections of the tower have been about 0.6. It can be observed that although models OT 1, OT 2, and OT 3 have about 2.5 times lesser number of members (168 members) in comparison to the 428 members of model UA, all four graphs in Fig. 36 are similar. A similar distribution of member properties in models is observed (i.e., a reduction in the utility ratio as the number of members is increased). Moreover, the forces on individual members decrease as the section sizes decrease – i.e., moving farther above from the foundation at higher levels. It is also observed that some sections of model UA fail under case 3 (blue dots on the right hand side of the red line), which is mitigated in all optimised models.

It is also worth to note that few members of the bottom bays of models OT had the highest utility ratio of 2.25 (with the cross sections considered during the morphogenesis process) were failing due to torsional effects during initial design checks. That generated a demand for additional bracings in the lower bays in order to get an improved performance, which was improved during the performance based design after iterations. Although this can be further improved simply by adding bracing members in the lower bay for reducing the effective length to less than half to obtain a retrogressive material usage from foundation to the apex.

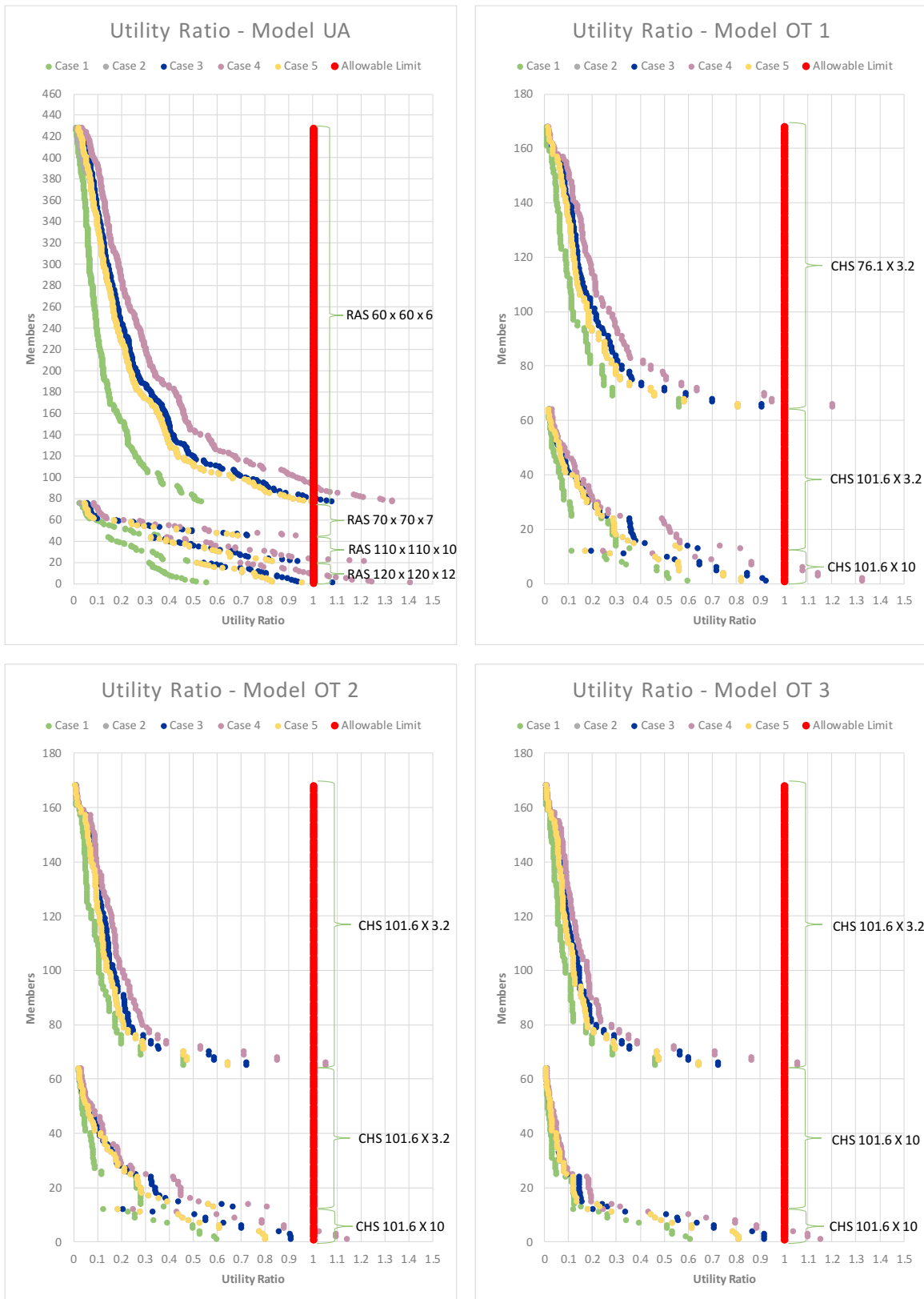

Fig. 36. Utility ratios.

Maximum displacement at top

Fig. 37 depicts the maximum resultant displacements. The maximum displacement of any element would be at the farthest distance from the support, provided it is an integral structure; meaning the stiffness of individual members perform in harmony, participating in forming

the global stiffness. Pertaining to this phenomenon, the displacement values at the peak of the tower models are taken for representing the most onerous condition. The governing load case for model case 1 and 2 is wind in diagonal direction. For the wind and ice combination, the governing load case is dominant wind in diagonal direction with accompanying ice. Along with this, dominant wind and accompanying ice in X and Z directions also show prominent displacement values, and thus should be checked for.

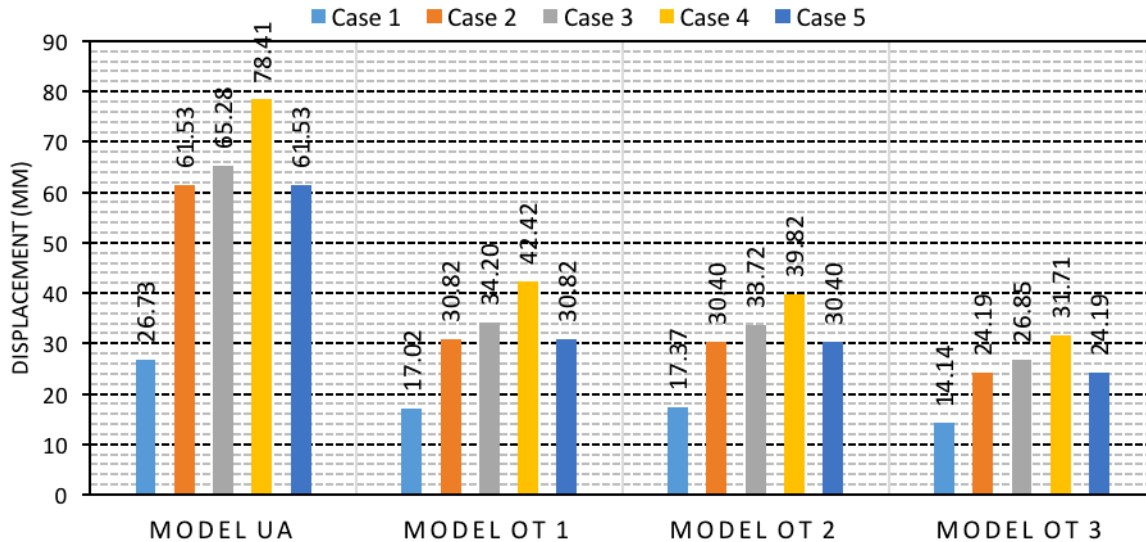

Fig. 37. Maximum displacements.

For case 3, with basic wind velocity of 30m/s, the displacement of tower UA is 65.28mm (having fundamental frequency of 5.074Hz). Displacement values of all the optimised towers are about half the value of tower UA. This imparts that Fig. 37 reveals a significant improvement in the structural performance. The values of displacements of the optimised models are less than almost half of that of model UA. This increased performance could be potentially further optimised by reducing the stiffness of the members in the effort to match the displacement of the existing model, since it is permissible, thus resulting into additional reduction in the total mass (with less visual intrusion).

The horizontal deflection limit is not prescribed in Eurocode 3, but according to NCCI/SN034a-EN-EU, the value shall not exceed  $H/300$  for medium rise buildings for the UK. Considering this, the permissible limit of maximum deflection is 63.33mm. Model UA fails in the most onerous case 3, while all the optimised models pass by a large margin; where the deflection values hardly surpass half the magnitude of the maximum allowable limit.

### Mass Participation

Table 8 clearly shows that the mass participation in the optimised models is almost double in comparison with model UA for Case 3 in the first mode. This could be a result of two possible improvements; the reduced number of members and/or the improved geometrical profile.

The initial study of topology optimisation claimed that the optimised tower needs to be taken care of for torsional effects as no horizontal bracings are provided unlike in the tower UA. Mass participation in two axes simultaneously in a single mode generates torsion. Looking at the mass participation ratios, tower UA does not show any significant signs of torsion during the analysis (usually in the 3<sup>rd</sup> mode). The optimised models show mass participation in X

and Z direction simultaneously with very negligible participation in the X direction. For the purpose of a sound design, the number of modes to be considered shall be at least up to 90% of the mass participation. The total number of modes to be considered to get a sum of 90% mass participation ratio (MPR) are 28, which is quite large. The excitation due to wind combined with fatigue could cause significant damage to the structure, which may even lead to early failure. Unlike this, the mass participation in the optimised tower models is ranging from 91% to 95% in the very first mode. By means of engineering judgement, although the structure has a participation in torsional mode, the model would not be susceptible to failure caused by torsion. The total excitation of the tower is over 90% in Z direction itself in the very first mode (fundamental mode), allowing scope of negligence in the participation in the X direction, which is less than 0.1% in all optimised models.

Table 8. Mass participation factors for Case 3.

Model UA - Case 3						
MODE	X	Y	Z	SUMM-X	SUMM-Y	SUMM-Z
1	0.01	0.00	46.93	0.008	0	46.931
2	47.23	0.02	0.01	47.238	0.023	46.939
3	0.00	0.00	0.00	47.238	0.023	46.939
4	0.00	0.00	0.35	47.238	0.023	47.289
5	5.07	0.00	0.00	52.304	0.023	47.289
6	0.00	0.00	5.03	52.305	0.023	52.323
7	0.00	0.00	0.00	52.305	0.023	52.324
8	0.00	0.00	0.11	52.305	0.023	52.439
9	29.97	0.22	0.00	82.275	0.241	52.441
10	0.00	0.00	30.04	82.277	0.241	82.477
11	0.00	0.00	0.00	82.277	0.241	82.477
12	0.00	0.00	0.00	82.277	0.241	82.477
13	0.00	0.00	0.00	82.277	0.242	82.477
14	0.00	0.00	0.00	82.277	0.242	82.477
15	1.06	0.04	0.00	83.334	0.281	82.477
16	0.00	0.00	1.00	83.334	0.281	83.478
17	0.00	0.00	0.00	83.334	0.285	83.478
18	0.00	0.66	0.00	83.335	0.948	83.478
19	0.00	0.00	0.00	83.335	0.949	83.478
20	0.00	0.00	0.00	83.337	0.95	83.478
21	5.93	0.43	0.01	89.264	1.38	83.49
22	0.01	0.00	5.86	89.277	1.383	89.355
23	0.00	0.00	0.02	89.278	1.383	89.378
24	0.00	0.00	0.07	89.278	1.383	89.445
25	0.00	0.00	0.00	89.278	1.384	89.445
26	0.03	0.70	0.00	89.308	2.088	89.445
27	0.00	0.00	0.07	89.308	2.089	89.513
28	2.14	1.15	0.00	91.449	3.243	89.515

OPTIMISED MODELS						
Model OT 1 - Case 3						
MODE	X	Y	Z	SUMM-X	SUMM-Y	SUMM-Z
1	0.06	0.00	93.52	0.056	0	93.525
2	95.00	0.00	0.06	95.059	0.004	93.583
3	0.00	0.00	1.71	95.06	0.004	95.294
4	0.00	0.00	0.00	95.061	0.004	95.294
5	0.00	0.00	0.73	95.062	0.004	96.026

Model OT 2 - Case 3						
MODE	X	Y	Z	SUMM-X	SUMM-Y	SUMM-Z
1	0.05	0.00	91.81	0.051	0	91.814
2	92.84	0.01	0.05	92.891	0.006	91.865
3	0.00	0.00	1.31	92.892	0.006	93.18
4	5.85	0.08	0.02	98.746	0.089	93.203
5	0.02	0.00	5.52	98.77	0.089	98.721

Model OT 3 - Case 3						
MODE	X	Y	Z	SUMM-X	SUMM-Y	SUMM-Z
1	0.09	0.00	95.22	0.09	0	95.218
2	95.73	0.00	0.09	95.82	0.001	95.309
3	0.00	0.00	0.59	95.821	0.001	95.899
4	0.09	0.00	2.67	95.907	0.003	98.568
5	3.24	0.04	0.07	99.145	0.038	98.642

## 5.5 Discussion and limitations

All the elements of the towers are modelled as ‘Space’ elements due to a limitation in software package STAAD Pro V8i SS6, where a direct ‘Truss’ type modelling can only be done for up to 2D models. Truss members are either in axial compression or tension and take essentially no bending. No such specifications are given in the models analysed, which means that the members will be susceptible to pure axial force and axial with bending. The column members resist gravity loads, while the lateral forces are resisted by bracing members.

In order to check the behaviour of the optimised tower models with properties similar to a truss, partial moments (using a value of 0.995) were released in MY and MX direction in the members. This practice resulted significant failure in all members at the lower second bay, where they were failing with a utility ratio values ranging from 2.0 to 5.0. This was due to a significant increase in the axial forces in the bracing members from lateral wind and its combination with ice. As the end moments were released, the column members did not participate in taking any bending. This confirms that all the lateral forces are resisted by bracing members only. The lateral forces exceeded the capacity of bracing members, leading to their failure, subsequently transferring the force on the column members, which were not



designed to resist direct horizontal forces. When the same members were designed to take bending by discharging moment releases, member utility ratio fell under 1.0 - suggesting an efficient member utilisation. This implies that although a truss system is adopted in forming the exoskeleton of the optimised tower, providing pin connections does not contribute in forming an efficient design. Hence, the members should be designed to take bending too. However, the lowest members are assigned with pin supports to avoid transferring moments to the foundation, suggesting a lighter foundation design.

Due to lack of data for the type of ice to be considered in the UK, the ice accretion is considered by a simple approach as given in [BS EN 1993-3-1 \(2006, Annex C, C.3\)](#) than the one suggested by [ISO 12494 \(2001, Annex D\)](#). The ISO code suggests that the ice accretion is non-uniform. Eccentric accretion of ice on the members could amplify the response of the structure. Also, the most onerous load combination was dominant wind and accompanying ice, in which case most of the members were designed for the loads generated by this combination. This explains that icing effect cannot be ignored in the regions where temperatures can go as low as 0 degree Celsius.

Implementation of a quasi-static approach is a decent alternative to wind tunnel testing or finite element modelling to start with. That said, the exact behaviour could not be known by this method unless the loads are calculated and applied at every point of the tower, which is quite onerous. The fundamental frequencies derived from STAAD Pro modelling were used to evaluate amplified loads which increased in the structural factor due to a quasi-static analysis.

## 5 CONCLUDING REMARKS

A structurally improved novel lattice telecommunication tower is developed through the application of structural topology optimisation design process. Topology optimisation techniques led to a significant reduction of the overall number of individual structural components (from 316 on the standard model to 160 in the new model) and an overall weight reduction. The number of connections and the maintenance requirements for connections and members is also considerably reduced. The bending stiffness of the optimised model OT was increased for both axes, as a result of the new exoskeleton topology. Due to the higher stiffness, higher frequencies ( $f_i$ ) were also evidently observed. Regarding the torsional modes, the natural frequency  $f_4$  of the initial model UA was found slightly higher than the natural frequency  $f_6$  of the optimised model OT and it is suggested that the torsional behaviour of the optimised tower can be further improved by introducing diaphragm systems or key diagonal members at locations particularly near the base of the tower. In an attempt to make the optimised tower, even further, less visual intrusive as well as to achieve a reduced wind drag, EHS members were employed. EHS can offer a large reduction in the surface area and consequently the solidity ratio of the tower along the wind direction.

Thereafter, a performance-based design process was established with further modifications on the optimised model and mainly focusing on the cross-section properties. Model OT 1 and OT 2 have reduced masses, the former proving to be the best of all. Due to reduction in the total mass, there is a significant reduction in the vertical reaction of supports. This proves to be advantageous when performing the foundation designs. Also, the maximum displacement values are very low in the optimised models, where Model OT 2, to some extent, is improved than Model OT 1, still both showing excellent performance in comparison to the existing

model UA. Optimised model OT 3 shows satisfactory results in most of the design parameters such as fundamental frequency, utility ratio, maximum displacement and mass participation, however it clearly lacks efficiency in the mass reduction. In fact, the total mass exceeds that of the existing tower, model UA. This infers that in an attempt to achieve improved buildability, one has to compromise on the mass, which does not seem to result a sound design. The utility ratio of all the optimised models is nearly same as that of the existing model, but none of the members fail in the optimised models unlike that of model UA. This is in exclusion to case 4 which is tested against the maximum ice loads found in the UK. The results due to excessive ice accretion do not deviate much from the other cases, however failure of some members in the lower storey due to the increased mass of the whole structure, leading to weakening of the members in lower storey. More significantly, there was deviation in the mass participation ratios of all the tower models. The modal mass participation was ranging from 46% to 47% in the first two modes for Tower UA while it was between 91% and 95% for all the optimised tower models. This is a remarkable advancement in terms of performance for an optimised exoskeleton, thus making it an ideal case study to work on further so as to work only on the structural part of optimisation.

In conclusion, design of lattice telecommunication towers can be optimised to a certain extent without compromising their buildability, function, and structural integrity; in fact, improving their performance against wind and ice loads by changing the overall morphology creating less visual intrusive and lightweight towers and selecting appropriate cross-sections members as it was presented in this paper. The influence and significance of the design factors suggesting a feasible design have been presented.

## REFERENCES

- Abdelwahab M, Tsavdaridis KD. 2019. Optimised 3D-Printed Metallic Node-Connections for Reticulated Structures. The 9th International Conference on Steel and Aluminium Structures. 3-5 July, 2019, Bradford, UK (<https://engrxiv.org/jkexd/>)
- Albermani F, Mahmendran M, Kitipornchai S. 2004. Upgrading of transmission towers using a diaphragm bracing system. *Engineering Structures*. 26(6), 735-744.
- Altair. 2012. *VIII Element Quality and Checks*. ([http://www.altairuniversity.com/wp-content/uploads/2012/04/Student\\_Guide\\_211-233.pdf](http://www.altairuniversity.com/wp-content/uploads/2012/04/Student_Guide_211-233.pdf))
- Altair. 2014. *3D Meshing*. (<http://www.altairuniversity.com/wp-content/uploads/2014/02/3DMeshing.pdf>)
- Ballaben JS, Guzman AM, Rosales MB. 2011. Parametric studies of guyed towers under wind and seismic loads. In: *Mecánica Computacional Vol XXX, 1/4 November 2011, Rosario*. Argentina: Association Argentina de Mecánica Computacional, 1019-1032
- Baniotopoulos C, Stathopoulos T. 2007. Wind effects on buildings and design of wind-sensitive structures. Italy: SpringerWien New York
- Bechmann H. 1995. *Vibration Problems in Structures: Practical Guidelines*. Zurich: Insitut fur baustatik and konstruktion.
- Bendsøe MP. 1989. Optimal shape design as a material distribution problem. *Structural Optimization*. 1(4), 193-202
- Bendsøe MP, Sigmund O. 2003. *Topology optimization: Theory, methods and applications*. Berlin: Springer
- Bendsøe MP, Kikuchi N. 1988. Generating optimal topologies in structural design using a homogenization method. *Computer Methods in Applied Mechanics and Engineering*. 71(2), 197-224
- Beghini LL, Beghini A, Katz N, Baker FW, Paulinho GH. 2014. Connecting architecture and engineering through structural topology optimization. *Engineering Structures*. 59, 716-726.

- Belevičius R, Jatulis D, Šešok D. 2013. Optimization of tall guyed masts using genetic algorithms, *Engineering Structures* 56, 239–245
- BS EN 1990:2002+A1:2005. Eurocode 0: Basis of Structural Design. Brussels: The European Union per Regulation
- BS EN 1991-1-4:2005. Eurocode 1: Actions on Structures – Part 1-4: General actions – Wind actions. UK: BSi
- BS EN 1993-1-1:2005. Eurocode 3: Design of Steel Structures – Part 1-1: General rules and rules for buildings. Brussels: The European Union per Regulation
- BS EN 1993-3-1:2006. Eurocode 3: Design of Steel Structures – Part 3-1: Towers, Masts and Chimneys – Towers and Masts. Brussels: The European Union per Regulation
- Carril Jr CF, Isyumov N, Reyolando MLRF. 2003. Experimental study of the wind forces on rectangular latticed communication towers with antennas. *Journal of Wind Engineering and Industrial Aerodynamics*. 91(8), 1007-1022
- Celio F, Carril Jr, Isyumov N, Reyolando MLRF Brasil. 2003. Experimental study of the wind forces on rectangular latticed communication towers with antennas. *Journal of Wind Engineering and Industrial Aerodynamics* 91 (2003) 1007–1022
- Coventry City Council. 2005. Supplementary guidance note ‘telecommunications – a design guide’. UK: Coventry City Council.
- Das A, Kumar S. 2015. Modelling and Analysis of Lattice Towers for Wind Turbines. *International Journal of Science and Research (IJSR)*. 4(4), 999-1003
- Department for Digital, Culture, Media & Sport. 2019. Future Telecoms Infrastructure Review, UK.
- DIN 4131:1991, Steel Radio Towers & Masts, German Institute for Standardisation.
- DIN EN 1991-1-1 NA:2010, National Annex - Nationally Determined Parameters - Eurocode 1: Actions On Structures - Part 1-1: General Actions - Densities, Self-Weight, Imposed Loads for Buildings, German Institute for Standardisation
- Dorn WS, Gomory RE, Greenberg HJ. 1964. Automatic design of optimal structures, *J. Mecanique*3, 25–52
- Efthymiou E, Kaziolas DN, Baniotopoulos CC. 2009. On the response of steel telecommunication masts under environmental actions and seismic loading. In Proc. of 11<sup>th</sup> Nordic Steel Conference (NSCC2009), Malmo, Sweden, 375-381.
- Forest of Dean District Council. Telecommunications. ([http://www.fdean.gov.uk/nqcontent.cfm?a\\_id=6500](http://www.fdean.gov.uk/nqcontent.cfm?a_id=6500))
- Gilbert M, Tyas A. 2003. Layout optimization of large-scale pin jointed frames, *Eng.Comput.*20(8), 1044–1064
- Golikov A, Gubanov V, and Garanzha I. 2018. Atypical structural systems for mobile communication towers, IOP Conf. Series: Materials Science and Engineering, 365, 052010
- Grekačičius L, Hughes JA, Tsavdaridis KD, Efthymiou E. 2016a. Novel Morphologies of Aluminium Cross-Sections Through Structural Topology Optimisation Techniques. *Key Engineering Materials*. 710, 321-326 (<https://doi.org/10.4028/www.scientific.net/KEM.710.321>)
- Grekačičius L, Hughes JA, Tsavdaridis KD, Efthymiou E. 2016b. Novel Morphologies of Aluminium Cross-Sections Through Structural Topology Optimisation Techniques. The 13th International Aluminium Conference (INALCO 2016). 21-23 September 2016, Naples, Italy
- Groen JP, Sigmund O. 2018. Homogenization-based topology optimization for high-resolution manufacturable microstructures. *International Journal for Numerical Methods in Engineering*. 113(8), 1148-1163
- Hajirasouliha I, Pilakoutas K, Moghaddam H. 2011. Topology optimization for the seismic design of truss-like structures. *Computers and Structures*, 89(7-8), 702-711
- He L, Gilbert M, Johnson T, Pritchard T. 2019. Conceptual design of AM components using layout and geometry optimization. *Computers and mathematics with Applications*, 78, 2308–2324
- Holmes JD, Banks RW, Roberts G. 1993. Drag and aerodynamic interference on Microwave dish antennas and their supporting towers, *J. Wind Eng. Ind. Aerodyn.* 50, 263–270

- Jiang C, Jia H. 2006. Evolutionary based intelligent algorithm for topology optimization of structure. In: Sixth International Conference on Intelligent Systems Design and Applications. Vol. 1. California: IEEE, 897-902
- Kefal A, Sohoulis A, Oterkus E, Yildiz M, Suleman A. 2019. Topology optimization of cracked structures using peridynamics. *Continuum Mechanics and Thermodynamics*. 31(6), 1645-1672
- Kentli A. 2019. Topology Optimization Applications on Engineering Structures, IntechOpen publications.
- Kingman JJ, Tsavdaridis KD, Toropov VV. 2013. The Application of Topology Optimisation to the Design of Steel I-Section Beam Web Openings, The 14th International Conference of Civil, Structural and Environmental Engineering Computing (CIVIL-COMP 2013). 3-6 September 2013, Cagliari, Sardinia, Italy (<https://www.ctresources.info/ccp/paper.html?id=7556>)
- Kingman JJ, Tsavdaridis KD, Toropov VV. 2014. Applications of Topology Optimisation in Structural Engineering. Civil Engineering for Sustainability and Resilience International Conference (CESARE 2014). 24-27 April 2014, Amman, Jordan
- Kingman JJ, Tsavdaridis KD, Toropov VV. 2015. Applications of Topology Optimisation in Structural Engineering: High-rise Buildings & Steel Components. *Jordan Journal of Civil Engineering*, 9(3), 335-357
- Luo Z, Zhang N, Wang Y, Gao W. 2013. Topology optimization of structures using meshless density variable approximants. *International Journal for Numerical Methods in Engineering*. 93(4), 443-464
- Li L. Topology optimization of structures with microstructural and elastoplastic-damage effects [PhD thesis]. University of Notre Dame; 2018
- Liu WK, Jun S, Li S, Adee J, Belytschko T. 1995. Reproducing kernel particle methods for structural dynamics. *International Journal for Numerical Methods in Engineering*. 38(10), 1655-1679
- LS Telecom. 2016. 5G Infrastructure Requirements in the UK (final report), On behalf: of National Infrastructure Commission.
- Luo Y, Li Q, Liu S. 2019. A projection- based method for topology optimization of structures with graded surfaces. *International Journal for Numerical Methods in Engineering*. 118(11), 654-677
- Madugula MKS. 2002. *Dynamic Response of Lattice Towers and Guyed Masts*. USA: American Society of Civil Engineers
- McClure G, Lapointe A, Khedr MA. 2000. Seismic behaviour of steel lattice telecommunication towers. In: *Behaviour of Steel Structures in Seismic Areas, 21/24 August 2000, Montreal*. Netherlands: A.A. Balkema, 335-337
- Nielsen MG. 2014. Analysis and design of masts and towers. *Journal of the international association of shell and spatial structures*. 55(2), 79-88
- Nielsen MG, Støttrup-Andersen U. 2006. Advantages of using tubular profiles for telecommunication structures. In: *Tubular Structures XI Willibald, S. and Packer, J.A.*, 31 August/2 September, Quebec City. London: Taylor & Francis Group plc, 45-51.
- Nicolaou A, Tsavdaridis KD, Efthymiou E. 2018. Topology Optimisation Study for the Design of Lattice Towers. The 9th Greek National Steel Structures Conference. 5-7 October, 2017, Larissa, Greece ([http://eeme.ntua.gr/proceedings/9th/Papers/063\\_PAP\\_Nicolaou.pdf](http://eeme.ntua.gr/proceedings/9th/Papers/063_PAP_Nicolaou.pdf))
- Noii N, Aghayan I, Hajirasouliha I, Kunt MM. 2016. A new hybrid method for size and topology optimization of truss structures using modified ALGA and QPGA. *Journal of Civil Engineering and Management*. ISSN 1392-3730
- ISO 12494. 2001. Atmospheric Icing of Structures. International standard ISO 12494:2001 (Annex D)
- Olason A, Tidman D. 2011. Methodology for Topology and Shape Optimization in the Design Process. MSc. Thesis, Chalmers University of Technology.
- Oliveira MI, da Silva JG, Vellasco PC, de Andrade SA, de Lima LRO. 2007. Structural Analysis of Guyed Steel Telecommunication Towers for Radio Antennas. *Journal of the Brazilian Society of Mechanical Sciences and Engineering*, 29(2), 185-195
- Pospíšil S, Lahodný J, Janata V, Urushadze S, Král R, Hračov S. 2012. Lifetime prediction of wind loaded mast and towers with respect to lateral and longitudinal wind spectrum. In: 18th International Conference Engineering Mechanics, 14/17 May 2012, Svratka, Czech Republic. Czech Republic: 18th International Conference Engineering Mechanics.

- Pritchard T, Gilbert M, Tyas A. 2005. Plastic layout optimization of large-scale frameworks subject to multiple load cases, member self-weight and with joint length penalties, in: Proc. of 6th World Congresses of Structural and Multidisciplinary Optimization, Rio de Janeiro, Brazil, 2005.
- Rozvany GIN. 2008. A critical review of established methods of structural topology optimization. *Structural and Multidisciplinary Optimization*, 37, 2008, 217-237
- Saleem W, Lu H, Yuqing F. 2008. Topology Optimization-Problem Formulation and Pragmatic Outcomes by integration of TOSCA and CAE tools. In: Proceedings of the World Congress on Engineering and Computer Science, 22/24 October 2008, San Francisco. USA: IAENG, 1123-1128
- Sharma KK, Duggal SK, Singh DK, Sachan AK. 2015. Comparative analysis of steel telecommunication tower subjected to seismic & wind loading. *Civil Engineering and Urban Planning: An International Journal (CiVEJ)*. 2(3), 1-19
- Shieh RC. Massively parallel structural design using stochastic optimization and mixed neural net/finite element analysis methods. *Computing Systems in Engineering*. 1994;5(4-6):455-467
- Sigmund O, Maute K. 2013. Topology optimization approaches. *Structural and Multidisciplinary Optimization*. 48(6), 1031-1055
- Støttrup-Andersen U. 2009. Masts and Towers. In: International Association for Shell and Spatial Structures (IASS) Symposium, 28 September-2 October 2009, Valencia, Spain. Spain: International Association for Shell and Spatial Structures (IASS) Symposium.
- Støttrup-Andersen U. 2014. Masts and Towers. *Journal of the international association for shell and spatial structures*. 55(2), 69-78
- Stromberg LL, Beghini A, Baker FW, Paulino GH. 2012. Topology optimization for braced frames: Combining continuum and beam/column elements. *Engineering Structures*. 37(No issue number), 106-124
- Stromberg LL, Beghini A, Baker WF, Paulino GH. 2010. Application of layout and topology optimization using pattern gradation for the conceptual design of buildings. *Structural and Multidisciplinary Optimization*. 43(2), 165-180
- Stromberg LL, Beghini A, Baker FW, Paulino GH. 2012. Design of Structural Braced Frames Using Group Optimization. In: 20th Analysis and Computation Specialty Conference, 29/31 March 2012, Chicago. USA: Structures Congress 2012
- Stromberg LL, Beghini A, Baker WF, Paulino, GH. 2010. Application of layout and topology optimization using pattern gradation for the conceptual design of buildings. *Structural and Multidisciplinary Optimization*. 43(2), 165-180
- Szafran J. 2015. An experimental investigation into failure mechanism of a full-scale 40m high steel telecommunication tower. *Engineering Failure Analysis*. 54, 131-145
- The Constructor: Civil Engineering Home. Topology Optimization of Structures. 2019. Available from: <https://theconstructor.org/structural-engg/topology-optimizationof-structures/5721/>
- Tower Xchange. 2015. Journal of the Telecom Tower Industry in EMEA, CALA and Asia. Conference proceedings: Issue 13, July 2015  
([https://www.towerxchange.com/wp-content/uploads/2015/09/TX\\_ISSUE13\\_COMPLETE.pdf](https://www.towerxchange.com/wp-content/uploads/2015/09/TX_ISSUE13_COMPLETE.pdf))
- Tower Xchange. 2018. Journal of Record for International Tower Industry. Conference proceedings: Issue 23, July 2018  
([https://www.towerxchange.com/wp-content/uploads/2018/07/TowerXchange-Issue\\_23.pdf](https://www.towerxchange.com/wp-content/uploads/2018/07/TowerXchange-Issue_23.pdf))
- Tsavidaridis KD, Efthymiou E, Adugu A, Hughes JA, Grekavicius L. 2019. Application of Structural Topology Optimisation in Aluminium Cross-Sectional Design. *Thin-Walled Structures*. 139, 372-388
- Tsavidaridis KD, Kingman JJ, Toropov VV. 2014. Structural Topology Optimisation in Steel Structural Applications. In: Hellenic National Conference of Steel Structures, 2-4 October 2014, Tripoli, Greece ([http://eeme.ntua.gr/proceedings/8th/Papers/P058\\_PAP\\_Tsavidaridis2.pdf](http://eeme.ntua.gr/proceedings/8th/Papers/P058_PAP_Tsavidaridis2.pdf))
- Tsavidaridis KD, Kingman JJ, Toropov VV. 2015. Application of Structural Topology Optimisation to Perforated Steel Beams. *Computers and Structures*, 158, 108-123
- United Telecom Limited. 2011. Technical Specification of Ground Based Tower of 30,40 & 50m height. Nepal: United Telecom Limited.

- Xie YM, Steven GP. 1993. A simple evolutionary procedure for structural optimization. *Computers and Structures*, 49, 1993, 885-896
- Zolekar V, Wankhade LN. 2013. *Finite Element Analysis and Optimization of I.C. Engine Piston Using RADIOSS and OptiStruct*. India: Altair India ATC
- Zhang X, Ramos AS, Paulino GH. Material nonlinear topology optimization using the ground structure method with a discrete filtering scheme. *Structural and Multidisciplinary Optimization*. 2017;55(6), 2045-2072