



UNIVERSITY OF LEEDS

This is a repository copy of *Robotic flange system for active alignment of microwave, millimetre-wave and terahertz waveguides*.

White Rose Research Online URL for this paper:  
<http://eprints.whiterose.ac.uk/156507/>

Version: Accepted Version

---

**Proceedings Paper:**

Alkhorshid, Y and Robertson, I [orcid.org/0000-0003-1522-2071](https://orcid.org/0000-0003-1522-2071) (2017) Robotic flange system for active alignment of microwave, millimetre-wave and terahertz waveguides. In: 2016 46th European Microwave Conference (EuMC). 2016 46th European Microwave Conference (EuMC), 04-06 Oct 2016, London, UK. IEEE , pp. 1127-1130. ISBN 9781509015146

<https://doi.org/10.1109/eumc.2016.7824546>

---

© 2016 EuMA. Personal use of this material is permitted. Permission from IEEE must be obtained for all other uses, in any current or future media, including reprinting/republishing this material for advertising or promotional purposes, creating new collective works, for resale or redistribution to servers or lists, or reuse of any copyrighted component of this work in other works.

**Reuse**

Items deposited in White Rose Research Online are protected by copyright, with all rights reserved unless indicated otherwise. They may be downloaded and/or printed for private study, or other acts as permitted by national copyright laws. The publisher or other rights holders may allow further reproduction and re-use of the full text version. This is indicated by the licence information on the White Rose Research Online record for the item.

**Takedown**

If you consider content in White Rose Research Online to be in breach of UK law, please notify us by emailing [eprints@whiterose.ac.uk](mailto:eprints@whiterose.ac.uk) including the URL of the record and the reason for the withdrawal request.



[eprints@whiterose.ac.uk](mailto:eprints@whiterose.ac.uk)  
<https://eprints.whiterose.ac.uk/>

# Robotic Flange System for Active Alignment of Microwave, Millimetre-Wave and Terahertz Waveguides

Yasamin Alkhorshid\* and Ian D. Robertson

School of Electronic and Electrical Engineering, University of Leeds, United Kingdom

Corresponding author: i.d.robertson@leeds.ac.uk

\*Now at Technische Universität Chemnitz, Information & Communication Systems (ICS)

**Abstract-** This paper describes a computer vision based robotic waveguide flange alignment system that achieves improved repeatability of waveguide measurements. The proof-of-concept is demonstrated using WR-62 in the frequency band 12.40 GHz to 18 GHz. An Arduino was used to interface a three-channel NTS NanoDirect XYZ positioner with MATLAB and its image acquisition toolbox. The measured results of a back-to-back adapter pair demonstrate significantly improved repeatability with the automated system compared with manual alignment. Through EM modelling of two WR-1.0 rectangular waveguides over the frequency range 800 GHz to 1 THz it is shown that this new method for enhancing measurement repeatability will be invaluable.

**Keywords:** waveguides, measurement techniques, calibration

## I. INTRODUCTION

An intrinsic problem with microwave, millimetre-wave and terahertz component characterisation is waveguide flange misalignment when making precision measurements. In general, this misalignment happens as the result of machining and fabrication tolerances. The standard design of waveguide flanges with alignment pins is found to suffer from repeatability and alignment errors that are very significant at THz frequencies, requiring new approaches.

In most misalignment studies done so far, the design of the waveguide flange has been the main concern for millimetre and submillimetre-wave frequencies [1 - 4]. Some important methods for modification of the structure of waveguide flanges and accurate alignment of waveguides have been proposed [5].

This paper reports a new technique for improving the connection repeatability of millimetre and submillimetre-wave rectangular flanges using an active alignment system. In this first demonstration of a robotic flange, at Ku-band as proof-of-concept, a pair of cameras was employed to acquire the real-time image of the waveguide positions and a closed-loop feedback controller was used to align the flanges precisely. A graphical user-interface (GUI) was created in MATLAB™ to integrate the commands to be sent to the XYZ motor and acquire the images. An Arduino microcontroller was used to control the X, Y, and Z axis of the XYZ piezoelectric motor by sending commands to an NTS NanoDirect™ controller.

## II. REPEATABILITY OF MEASUREMENTS AND INTERCONNECTS

The need for improved repeatability is well-known in manufacturing and ATE where optimum trade-offs between speed of connection and performance are required [6]. Previously reported techniques for improvement of uncertainty and repeatability of measurement for millimetre and submillimetre-wave flanges mainly dealt with the design and fabrication methods and positioning of the holes and using rings with tight tolerance [7-10]. The alignment of waveguide sections is dependent on the flange alignment hole and alignment pins and any tolerances in the fabrication of the holes or alignment pins can result in alignment errors. In the THz region the waveguides are barely visible to the human eye and the tolerance of alignment structures is more significant compared with the waveguide itself, so it is highly appropriate to consider active alignment systems, drawing on the optical domain, to ensure that proper alignment is made.

## III. ROBOTIC FLANGE SYSTEM

The general structure of the proposed closed-loop system, which is shown in Figure 1, includes high definition vision systems capturing the position of the waveguides, sending the data to the controller software for data analysis, comparing the current position of the waveguide with the a reference model and control of the X,Y,Z motor.

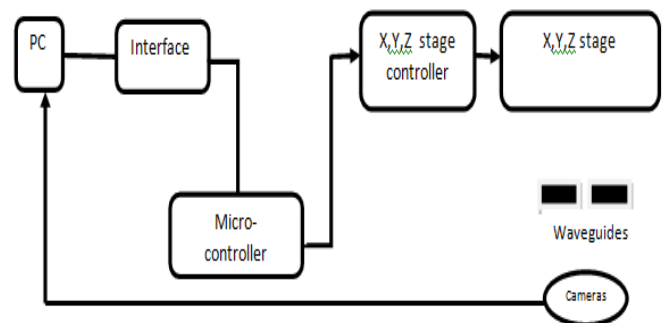


Figure 1. Block diagram of the active alignment system.

Real-time imaging of the waveguides was performed with the MATLAB image acquisition toolbox (imaqtool). A GUI interface was created to perform feedback, communicate with the Arduino microcontroller that transmits suitable commands to the XYZ stage controller (NTS NanoDirect). Thus, when the images are in MATLAB, the current position of the moving waveguide (x,y, and z values) is calculated and compared with the x,y, and z values of the reference images of the fixed waveguide which was previously acquired.

Two red spots were attached to the corners of the moving waveguide, as shown in Figure 3. A differential method was utilised to detect and achieve the red colour intensity. The acquired image was divided into sub-images to count the total red regions. The boundary condition set was to follow only one red spot. This program is regularly called by an embedded timer function which generates a fixed-delay event. This method helps to control the image acquisition function. A proportional controller (P Controller) is provided to compare the current position with the reference point.

#### IV. EXPERIMENTAL RESULTS AND DISCUSSIONS

The S11 and S21 measurements were made using an E8361A PNA Network Analyser from Agilent Technologies and two Ku-band rectangular waveguide-to-coax adaptors from Omni Spectra Inc. A two-port electronic calibration (Ecal) module from Agilent Technologies was employed to perform precise calibration at the coax ports. Two WR-62 waveguides were fixed on previously designed Perspex holders that were attached to the X, Y, Z mechanical translation stage and X, Y, Z piezoelectric motor. The cameras were located on the top and the side of the fixed WR-62 on the mechanical translation stage. A photograph of the robotic system and measurement setup is shown in Figure 2 and a screenshot of the GUI is shown in Figure 3.

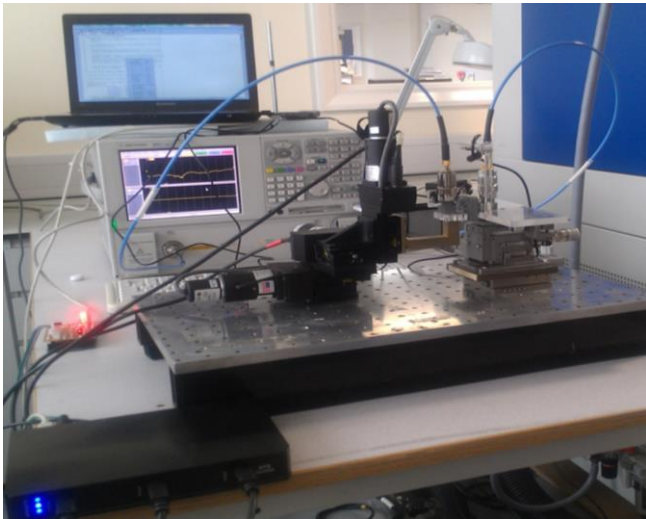


Figure 2. Robotic alignment system and measurement setup.

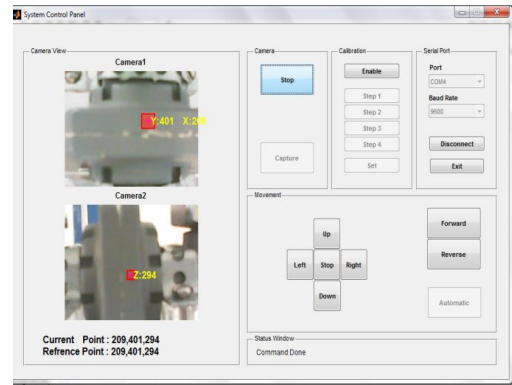


Figure 3. GUI control screen created in MATLAB

For the first measurement, two waveguides were aligned precisely using the allocated keys in the GUI (Up, Down, Left, Right, Forward, and Reverse). The position of waveguides was captured by the cameras to give a reference position on three axes, shown on the GUI screen. Afterwards, displacements in all three axes were applied to the second waveguide and the Automatic key and then the Start key were selected, respectively. Twenty independent connections and disconnections were made, each with a different initial displacement value. The obtained S11 and S21 traces indicate the capability of the flange alignment repeatability. For comparison, the same procedure was repeated using manual alignment. Figure 4 and Figure 5 compare the obtained S-parameters for the manual and automated connection methods.

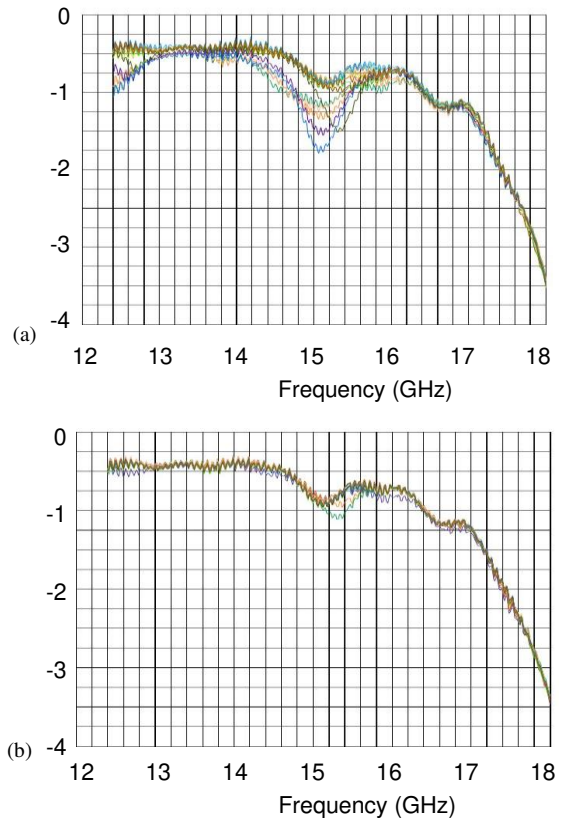
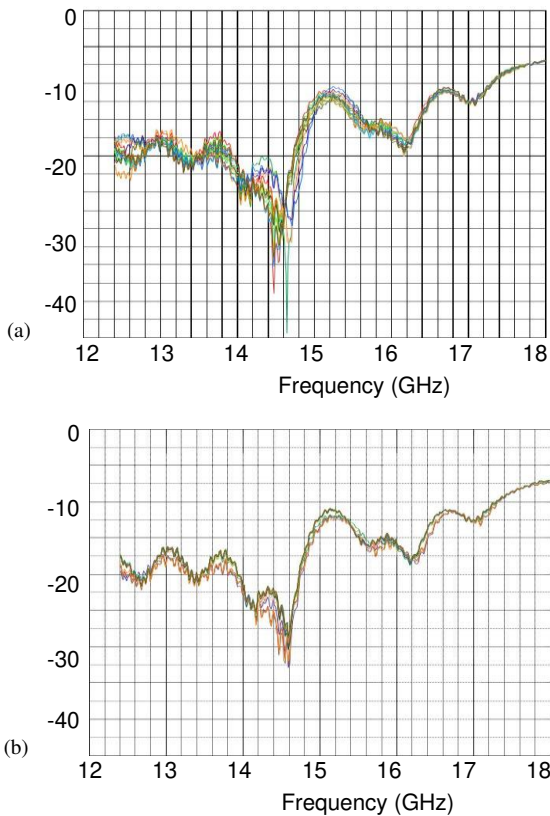


Figure 4. Measured S21 of back-to-back transitions using a) manual alignment, b) robotic alignment. (20 connect/disconnect cycles)

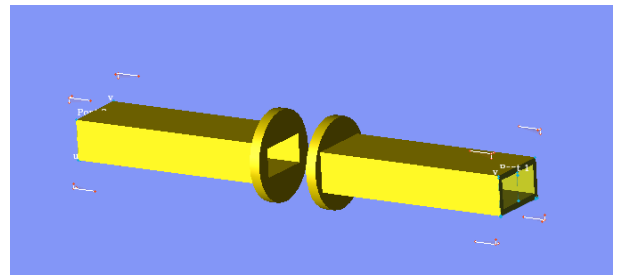


**Figure 5.** Measured S11 of back-to-back transitions using a) manual alignment, b) robotic alignment. (20 connect/disconnect cycles)

The results measured when using the robotic system, demonstrate the improved repeatability of the active alignment approach. Some controller error was observed, since the received frame rate from the camera is 30 frames per second, and this frame rate is not sufficient to perform real-time control, leading to overshoot. Hence, a PID controller is suggested to overcome this problem. To speed-up the alignment process, the total delay of the system should be decreased. For this purpose, a custom controller would be beneficial, in which the piezoelectric motors are driven directly by Arduino using an H-bridge and PWM signals.

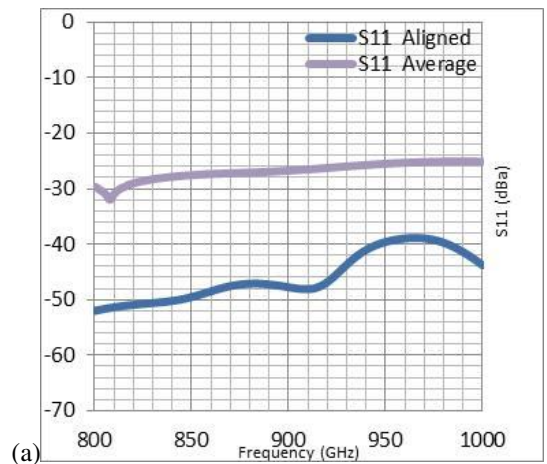
### V. TERAHERTZ APPLICATION

Some important work on waveguide flanges for frequencies above 325 GHz has resulted in new waveguide standards [11-13]. The proof-of-concept system is not compact enough for the alignment of two WR-1.0 waveguide flanges with a 254 microns internal width. However, we can investigate the issues through Agilent EMPro™ modelling. Here, WR-1.0 with 0.254\*0.127mm (10\*5mils) internal dimensions is considered (Figure 6) in order to study the mismatch errors over the frequency range of 800 GHz to 1 THz. The lower and upper cut-off frequencies for this waveguide according to the standards defined by IEEE P1785 [11, 13] are 590 GHz and 1180 GHz, respectively.

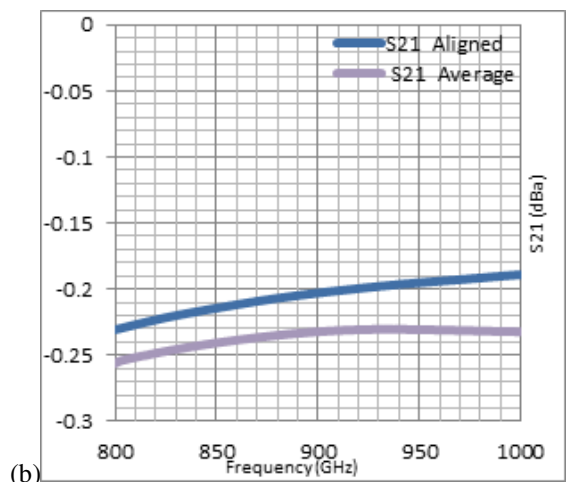


**Figure 6.** EMPro simulation for two WR-1.0 rectangular waveguide

The effect of misalignment was modelled for five situations: X axis (broad wall) misalignment, Y axis (E-plane), both X and Y axes, Z axis and rotated (skewed). Results with misalignment were compared with the perfectly aligned results. Figure 7 illustrates the S11 degradation due to 25  $\mu$ m misalignment in the E-plane direction, for example, while Figure 8 shows the effect of just 1degree of rotation (skew) misalignment on S11 (more results will be in the full paper).



(a)



(b)

**Figure 7.** (a) S11 and (b) S21 comparison between perfectly aligned waveguides and a pair with 25 microns of misalignment.



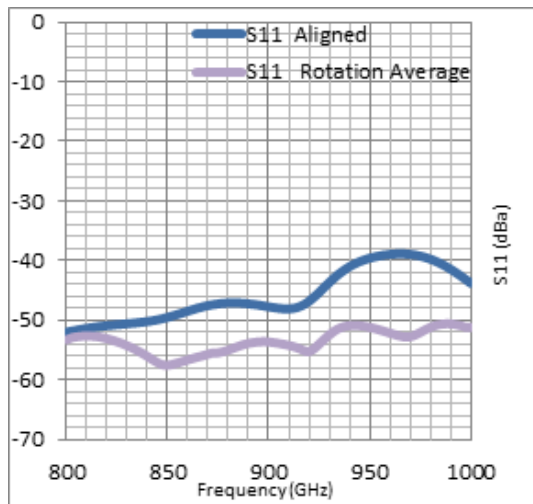


Figure 8. S11 comparison between perfectly aligned waveguides and 1 degree of rotational misalignment.

## VI. CONCLUSION

A new computer vision based robotic waveguide flange alignment system has been presented, demonstrating improved performance repeatability of waveguide measurements for WR-62. The measured results show that the active waveguide aligning system can achieve high precision in alignment owing to the use of imaging and feedback control techniques. The new technique is highly accurate, simple, and achieves measurement repeatability and will also be very useful for submillimetre-wave frequency applications. This method overcomes the tolerance limitation of the alignment pins and alignment holes. Further work will involve the design of waveguides with motors integrated into the flange and an improved alignment system for micron-level precision.

## REFERENCES

- [1] C.E. Collins, R.E. Miles, et al, "A new micro-machined millimetre-wave and terahertz snap-together rectangular waveguide technology", IEEE Microwave and Guided Wave Letters, Volume: 9, Issue: 2, pp 63-55,1999.
- [2] Yuenie S. Lau, A. Denning, "An innovative waveguide interface for millimeter wave and submillimeter wave applications", 69th ARFTG Microwave Measurements Conference digest, Honolulu, HI, pp 1-8, June 2007.
- [3] E. Pucci, "Contactless non-leaking waveguide flange realized by bed of nails for millimeter wave applications", 2012 6th European Conference on antennas and propagation (EUCAP), March 2012.
- [4] M.A. Maury, G.R. Simpson, "Improved Millimeter Waveguide Flanges Improved component and measurement", ARFTG Conference Digest-Winter, 26th ARFTG, Maury microwave corporation, Aug 1999, <http://www.maurymw.com/pdf/datasheets/5A-016.pdf>.
- [5] "Alignment of Waveguide Devices", Polytec PI Tech Note, 2002, (Accessed Jan 2016).
- [6] Application Note 1465-18, "6 Hints for Enhancing Measurement Integrity in RF/Microwave Test Systems Balancing the Tradeoffs Between Performance, Speed and Repeatability".
- [7] Masahiro Horibe, K. Noda, "Modification of waveguide flange design for millimetre and submillimeter-wave measurements", Microwave measurement conference (ARFTG), 77th ARFTG, IEEE conference publications, pp 1-7, 2011.
- [8] A. R. Kerr and S. Srikanth, "The ring-centered waveguide flange for submillimeter Wavelengths" Proc. 20th Int. Symp. on Space THz Tech., Charlottesville, VA, USA, pp. 220 – 222, April 2009.
- [9] Huilin Lil, A. R. Kerr, et al, "A ring-centered waveguide flange for millimetre and submillimeter-wave applications", Microwave Symposium Digest (MTT), IEEE MTT-S International, pp. 604 – 607, 2010.
- [10] J.L.Hesler, A.R. Kerr, et al, "Fabrication of calibration standards for the millimeter- and sub-millimeter wavelength ring-centered waveguide flange", Microwave Measurement Conference (ARFTG), 77th ARFTG, pp. 1-4, 2011.
- [11] John S. Ward, "New Standards for Submillimeter Waveguides", 17th International Symposium on Space Terahertz Technolog., Paris, France., pp.278, May 2006.
- [12] J.L. Hesler, A.R. Kerr, W. Grammer, and E. Wollack, "Recommendations for Waveguide Interfaces to 1 THz", 18th International Symposium on Space Terahertz Technology, Pasadena, March 2007.
- [13] Jeffrey Hesler, VDI (USA), "IEEE P1785 Workgroup - Progress on the Standardization of THz Waveguides and Interfaces", (Document 15-12-0351-01-0thz), <https://mentor.ieee.org/802.15/dcn/12/15-12-0418-00-0thz-ig-thz-closing-plenary-slides-july-2012.pdf>, (Accessed Aug 2012).