



This is a repository copy of *Predictive functional control for integrator systems*.

White Rose Research Online URL for this paper:  
<http://eprints.whiterose.ac.uk/156208/>

Version: Accepted Version

---

**Article:**

Zhang, Z., Rossiter, J. [orcid.org/0000-0002-1336-0633](https://orcid.org/0000-0002-1336-0633), Xie, L. et al. (1 more author) (2020) Predictive functional control for integrator systems. *Journal of The Franklin Institute*, 357 (7). pp. 4171-4186. ISSN 0016-0032

<https://doi.org/10.1016/j.jfranklin.2020.01.026>

---

Article available under the terms of the CC-BY-NC-ND licence  
(<https://creativecommons.org/licenses/by-nc-nd/4.0/>).

**Reuse**

This article is distributed under the terms of the Creative Commons Attribution-NonCommercial-NoDerivs (CC BY-NC-ND) licence. This licence only allows you to download this work and share it with others as long as you credit the authors, but you can't change the article in any way or use it commercially. More information and the full terms of the licence here: <https://creativecommons.org/licenses/>

**Takedown**

If you consider content in White Rose Research Online to be in breach of UK law, please notify us by emailing [eprints@whiterose.ac.uk](mailto:eprints@whiterose.ac.uk) including the URL of the record and the reason for the withdrawal request.



[eprints@whiterose.ac.uk](mailto:eprints@whiterose.ac.uk)  
<https://eprints.whiterose.ac.uk/>

# Predictive Functional Control for Integrator Systems

Zhiming Zhang<sup>a</sup>, John Anthony Rossiter<sup>b</sup>, Lei Xie<sup>a,\*</sup>, Hongye Su<sup>a</sup>

<sup>a</sup>*State Key Laboratory of Industrial Control Technology, Zhejiang University, Hangzhou, China*

<sup>b</sup>*Department of Automatic Control and System Engineering, University of Sheffield, Sheffield, UK*

---

## Abstract

This paper presents a novel modification and insights in the topic of predictive functional control (PFC) [1, 2]. Of particular interest is the consistency between the predictions deployed by PFC and the desired closed-loop behaviour. This paper focuses on integrator systems which pose some challenges to a conventional PFC algorithm and compares and contrasts two simple alternative but very effective modifications (one of which is novel) which enable better consistency of predictions and thus enable easier tuning and more reliable closed-loop behaviour. These insights are used to give some conclusions and proposals for how more challenging dynamics might be handled.

*Keywords:* predictive functional control, OFPFC, LPFC, integrator systems, prediction design

---

## 1. Introduction

Predictive functional control (PFC) is popular in industry [3, 4, 5, 6, 7] due to its simplicity, efficacy and low cost. Specifically, it is competitive in price with PID while having potentially improved functionality in that, being model based, it can cope with higher order dynamics and also deal with constraints in a reasonably systematic fashion. It should be emphasised here, that PFC is not a competitor with more advanced, and far more expensive, predictive control

---

\*Corresponding author

*Email address:* lxie@zju.edu.cn (Lei Xie)

algorithms such as Dynamic Matrix Control (DMC) [8], **Generalized predictive control (GPC)** [9] or dual mode approaches [10] and as such, must not be compared with those.

The application scope of PFC is also slightly different from other predictive control algorithms. PFC is more suitable to SISO systems and notably is ideally equipped to control systems with fast dynamics [1, 11]; DMC and GPC are generally used on systems with slow dynamics and/or MIMO characteristics [12]. The underlying reason is that the coding implementation of PFC is both very simple and also computationally very efficient and thus can be used even on devices with limited computing resources.

An unsurprising consequence of PFC being a simpler approach is that it does not in general have the theoretical guarantees of convergence or performance [13, 14] that one can obtain with dual mode approaches [10]. Of specific interest here, PFC may deal inconsistently with different types of open-loop dynamics [15]. This paper is particularly interested in the tuning of PFC. PFC has notionally just one tuning parameter which is the desired closed-loop response time (CLTR). However, it has been shown [15, 16] that, with the exception of first order systems, this tuning parameter has a weaker than desirable influence on the closed-loop behaviour that results.

Consequently, the original developers of PFC [6, 17] proposed a number of practical modifications to cope with systems which include different types of dynamics. In general terms, one could argue that these modifications are fit for purpose because they work, but from an academic point of view they are somewhat unsatisfying in that the underlying ethos and principles are not explained or justified and perhaps more critically, a researcher is left with questions as to whether improved and more systematic alternatives exist. A prime purpose of this paper is to propose an improved implementation of a concept previously deployed in PFC for integrator system implementations and explore its efficacy and rationale. Moreover, this modification will be compared with a recent alternative structure [18] that has appeared in the literature.

In the longer term, the aim will be to consider how PFC deals with a more

extensive range of challenging dynamics such as double integrators, right half  
40 plane poles and significant non-minimum phase characteristics. From an academic perspective, it would be better to aim for a sound systematic approach which covers a range of systems rather than different solutions for every problem as currently seems to be the case; of course the latter may turn out to be academically and economically justifiable.

45 The contributions of this paper are threefold:

- The inconsistencies in conventional PFC are analyzed when PFC deals with integrator systems.
- Two modifications of conventional PFC are introduced, one of which has a novel control structure and one which shapes the input prediction directly. The input structure and closed-loop poles of the two modified  
50 PFC algorithms are analyzed from which systematic tuning guidance is provided.
- A systematic constraint handling procedure for the modified PFCs is presented; this is essential for industrial application.

55 The paper begins in section 2 with a brief introduction to the basic PFC algorithm and then highlights why this is inappropriate in principle for an integrator system; even if the conventional algorithm still works, to some extent being built on incorrect foundations is not desirable. Section 3 introduces the two modifications used to improve behaviour: (i) one of these uses a prestabilisation concept previously deployed in PFC but in a somewhat ad hoc and poorly  
60 explained manner. Here a more systematic implementation output feedback PFC is proposed and clear tuning guidance derived; (ii) the second alternative has appeared more recently in the literature, called Laguerre PFC [18]. Section 4 will then analyze carefully the assumptions within each approach and how  
65 these may or may not lead to consistent decision making and thus the expectations of the desired behaviour. Constraints handling methodologies for two approaches are also presented. Section 5 will give some numerical examples and

is followed by conclusions and future work in section 6.

## 2. Conventional PFC and issues with integrator systems

### 70 2.1. Conventional PFC

This section will provide a brief introduction to conventional PFC. The conventional PFC algorithm assumes that the predicted future input is constant, which is a significant feature of PFC and simplifies the formulation [6].

Assuming that the setpoint is a constant  $R$ , for a system output  $y_{p,k}$  at time instant  $k$ , the desired reference trajectory  $i$ -steps ahead is defined as  $r_{k+i}$  where:

$$r_{k+i} = y_{p,k} + (R - y_{p,k})(1 - e^{-i\frac{3T_s}{CLTR}}), \quad i = 1, 2, \dots \quad (1)$$

$T_s$  is the sampling time and  $CLTR$  is the desired closed-loop settling time to within 5% error (which implies a time constant of  $CLTR/3$ ). For simplicity of 75 the representation hereafter,  $\lambda = e^{-\frac{3T_s}{CLTR}}$  is used for the rest of this paper, as the desired closed-loop pole.

In a conventional PFC algorithm the user defines a coincidence horizon  $n_y$ . The  $n_y$  samples ahead output prediction  $y_{p,k+n_y|k}$ , made at sample  $k$ , is forced to be equal to the reference trajectory (1) and thus:

$$y_{p,k+n_y|k} = r_{k+n_y} = y_{p,k} + (R - y_{p,k})(1 - \lambda^{n_y}). \quad (2)$$

The  $n_y$ -step ahead prediction for a transfer function model (e.g. [9, 14]) takes the following form for inputs  $u_k$ :

$$y_{p,k+n_y|k} = H\overrightarrow{u_k} + P\overleftarrow{u_k} + Q\overleftarrow{y_{m,k}} + d_k \quad (3)$$

where parameters  $H$ ,  $P$ ,  $Q$  depend on the model parameters,  $d_k$  is an offset correction term,  $y_{m,k}$  is the output of an internal model and for a model of order  $l$ :

$$\overrightarrow{u_k} = \begin{bmatrix} u_k \\ u_{k+1} \\ \vdots \\ u_{k+n_y-1} \end{bmatrix}; \quad \overleftarrow{u_k} = \begin{bmatrix} u_{k-1} \\ u_{k-2} \\ \vdots \\ u_{k-l} \end{bmatrix}; \quad \overleftarrow{y_{m,k}} = \begin{bmatrix} y_{m,k} \\ y_{m,k-1} \\ \vdots \\ y_{m,k-l} \end{bmatrix}$$

Thus, substituting prediction (3) into (2) gives:

$$H\underrightarrow{u_k} + P\underleftarrow{u_k} + Q\underrightarrow{y_{m,k}} + d_k = y_{p,k} + (R - y_{p,k})(1 - \lambda^{n_y}) \quad (4)$$

The constant future input assumption [6, 19] of PFC means  $u_{k+i} = u_k$  for  $i > 0$ , hence row  $H$  can be replaced by  $H_1$  where  $H_1 = H \cdot [1, 1, \dots]^T$  which is then used to construct the unconstrained control law, thus:

$$u_k = \frac{1}{H_1} \left[ (R - y_{p,k})(1 - \lambda^{n_y}) + y_{p,k} - Q\underrightarrow{y_{m,k}} - P\underleftarrow{u_k} - d_k \right] \quad (5)$$

Here notation  $y_{p,k}$  is used for the actual system output measurement and  $y_{m,k}$  is the internal model output, both at sample  $k$ . Generally one uses  $y_{p,k} = y_{m,k} + d_k$  to estimate a suitable value for  $d_k$ .  
80

**Remark 1.** *It is implicit within PFC that assuming one uses unbiased prediction (details omitted here for brevity), the control law (5) will include integral action and thus give offset free tracking, including in the presence of some model uncertainty and disturbances. This paper does not consider a formal sensitivity analysis and thus how much parameter uncertainty is allowable.*  
85

**Remark 2.** *For a model with first order dynamics such as  $(1 - az^{-1})y_m(z) = z^{-1}bu(z)$ , it is possible to write down expressions for  $H_1$ ,  $P$ ,  $Q$  by inspection.*

$$P = 0; \quad Q = a^{n_y}; \quad H_1 = b \frac{1 - a^{n_y}}{1 - a} \quad (\text{if } |a| < 1) \quad (6)$$

*Without lose of generality, this paper assumes  $a > 0$ ,  $b > 0$ .*

## 2.2. Inconsistencies in PFC design with integrator systems

Given a discrete integrator system (assume positive gain hereafter without loss of generality):

$$G_p(z) = \frac{bz^{-1}}{1 - z^{-1}}, \quad b > 0 \quad (7)$$

the output  $y_p$  is the integral of past values of input  $u$ . According to [6], PFC fails to control the integrator system properly because the system is not asymptotically stable. This would also be evident from inspection of  $H_1$  in (6) where  
90

substituting the value  $a = 1$ , it is clear that  $H_1$  is undefined using the short-cut formulae. More precisely, the step response of an integrator system gives a ramp and thus the predicted output is not convergent. Fig.1 illustrates clearly the inconsistency between the predictions deployed by PFC for an integrator system and the resulting closed-loop behaviour.  $b = 0.1$  is used in Eq(7),  $\lambda$  is 0.7 and  $n_y = 5$ . At time instant 10, the setpoint is changed from 0 to 5. The predicted system output, and also the closed-loop output, are clearly quite different from the desired reference trajectory. This inconsistency is worrying and not the right foundation for a reliable control law.

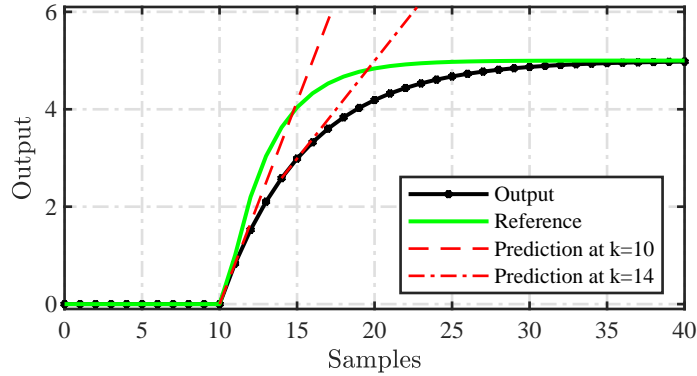

Figure 1: Inconsistency between predictions (red) and the resulting closed-loop behaviour (black) when controlling an integrator system with conventional PFC.

**Remark 3.** For an integrator system, although a conventional PFC algorithm may still give stable closed-loop behaviour, the closed-loop response is quite different from the open-loop predictions. This inconsistency means that the PFC controller may be unreliable and its behaviour may also vary significantly with different choices of coincidence horizon.

### 3. Modifications to conventional PFC

This section concisely describes two modifications to PFC which enable better consistency between the predictions and desired closed-loop behaviour. The

main argument is that, the more consistency there is between the optimised predictions and the resulting closed-loop behaviour, the more reliable the decision making and control is likely to be; indeed this is an underlying principle behind more advanced predictive control laws [10, 20] where it is an essential component of the guarantees of stability those algorithms offer. For the sake of generality this section gives the derivations with a generic first order system and the focus to integrator systems, which are a special case, comes in the following sections.

The original PFC principle, matching predictions to a first order target, is clearly well posed when the underlying system is a first order system as one can easily get consistency between the two [15]. However, this is less obviously the case for other dynamics as was indicated in subsection 2.2 for an integrator system and also highlighted in [15]. The system format and model used in this section are still eqn.7.

### 3.1. Predictive functional control with an inner output feedback loop

This section is a core contribution of the paper and explains and illustrates a simple method for improving PFC behaviour with integrator systems; it is denoted as output feedback PFC (OF-PFC). The specific innovation is to modify the implied assumption in conventional PFC that the future input is constant, which of course causes the integrator output to become a ramp; something we do not want. The basic principle is not unlike concepts in dual-mode MPC [10, 14] whereby one first chooses to pre-stabilise or shape the undesirable dynamics before applying predictive control. The main argument is that now the predictive control law is manipulating convergent dynamics and thus is able to construct sensible *optimised predictions*.

For an integrator system, a very simple stabilising feedback loop is shown in Fig. 2. A new input  $v_k$  is defined, using the model output  $y_{m,k}$  as a feedback parameter.

$$u_k = v_k - Ky_{m,k} \tag{8}$$



Consequently, the prediction model to be deployed **is** changed. Define the inner closed-loop transfer function in Fig. 2 as  $P(z) = [bz^{-1}/(1 - (1 - bK)z^{-1})]v(z)$  such that  $y_m(z) = P(z)v(z)$ . The core point is summarised in the following Lemma.

**Lemma 1.** *Build a PFC control law to control feedback loop from Fig. 2 using  $v_k$  as the control variable and  $y_{m,k}$  as the **prediction** output and assuming  $0 \leq 1 - bK < 1$ . The corresponding closed-loop system will behave like PFC controlling a stable first order model.*

*Proof.* This is obvious as  $P(z)$  has the same structure as a standard first order model, that is:

$$P(z) = \frac{bz^{-1}}{1 - (1 - bK)z^{-1}} \quad (9)$$

It is clear that  $0 \leq 1 - bK < 1$  ensures that  $P(z)$  is stable.  $\square$

**Theorem 1.** *Assuming the structure of Fig. 2, if  $v_k$  is chosen by a PFC control law to control  $P(z)$ , then the implied choice of  $u_k = v_k - Ky_{m,k}$  will control the underlying integrator model.*

*Proof.* This is obvious as the output of the integrator system  $G_m(z)$  is the same as the output of  $P(z)$ .  $\square$

**Algorithm 1.** *OPFPC: Construct the feedback structure shown in Fig. 2 where  $P(z)$  is an internal model,  $G_m$  represents the integrator model and  $G_p$  the actual system. Here OPFPC is used to select the signal  $v_k$  to control the model  $P(z)$ . This, in turn, is used to compute input  $u_k$  using  $u_k = v_k - Ky_{m,k}$  which is then implemented on the real system  $G_p$ . It is noted that the predictions from  $P(z)$  are corrected for bias by adding the offset term  $d_k = y_{p,k} - y_{m,k}$  in the standard way. The control law is*

$$v_k = \frac{(R - y_{p,k})(1 - \lambda^{n_y}) + y_{p,k} - d_k - (1 - bK)^{n_y} y_{m,k}}{(1 - (1 - bK)^{n_y})/K} \quad (10)$$

and  $u_k$  is

$$u_k = K \cdot \frac{(R - y_{p,k})(1 - \lambda^{n_y}) + y_{p,k} - y_{m,k} - d_k}{1 - (1 - bK)^{n_y}} \quad (11)$$

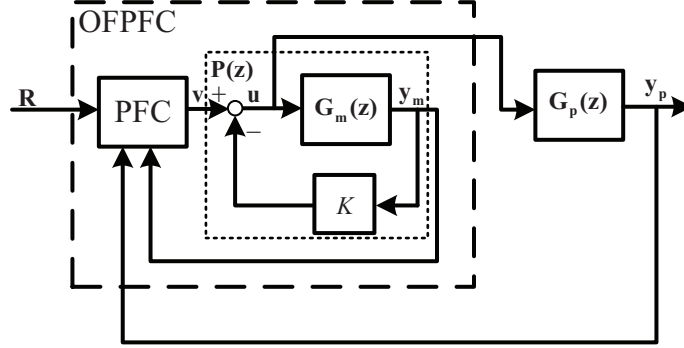

Figure 2: The overall OFPFC structure for Algorithm 1 including the modified internal model.

**Remark 4.** *The gain  $K$  ( $0 \leq 1 - bK < 1$ ) in the feedback loop of Fig. 2 is an additional degree of freedom which needs to be selected offline. To our knowledge, advice on this selection and the repercussions of different choices does not currently exist in the literature. Some original works about how to*  
 150 *choose  $K$  will be introduced in section 4.*

### 3.2. Using different parameterisations of the future input trajectory

An alternative modification to enable the integrator output to converge is by shaping the input prediction directly [20]. Laguerre PFC (LPFC) was recently proposed where instead of using a constant, the future input is parameterised as:

$$u(z) = \frac{u_{ss}}{1 - z^{-1}} + \frac{\eta_k}{1 - \gamma z^{-1}} \quad (12)$$

where  $u_{ss}$  is the estimated steady input and  $\gamma$ ,  $0 \leq \gamma < 1$  is a Laguerre pole which needs to be selected offline. Also,  $\eta_k$  is the degree of freedom to be used in  
 155 place of  $u_k$ . In [20], integrator systems are not tested, so this will be discussed next.

**Theorem 2.** *With the input parameterised as in (12), the output predictions will settle at the desired steady-state.*

*Proof.* The input defined in (12) has the property that:

$$\lim_{k \rightarrow \infty} u_k = \lim_{z \rightarrow 1} (z - 1)u(z) = u_{ss} \quad (13)$$

which, from the definition of  $u_{ss}$ , necessarily implies that:

$$\lim_{k \rightarrow \infty} y_k = R \quad (14)$$

□

160 Note that (12) is equivalent to  $\underline{u}_k = L_1 \eta + u_{ss}$ , where  $L_1 = [1, \gamma, \gamma^2, \dots, \gamma^{n_y-1}]^T$ , is the coefficient vector of a first order Laguerre polynomial. **For an integrator model,  $u_{ss}$  obviously equals to zero (assuming no uncertainty).**

**Algorithm 2.** *LPFC: Use the predicted shaped input  $u(z) = u_{ss}/(1 - z^{-1}) + \eta_k/(1 - \gamma z^{-1})$  to form the output predictions used to solve PFC law (2). For an integrator model:*

$$\eta_k = \frac{(R - y_{p,k})(1 - \lambda^{n_y}) + y_{p,k} - d_k - y_{m,k}}{b(1 - \gamma^{n_y})/(1 - \gamma)} \quad (15)$$

*At each sample time, only the first value of  $\underline{u}_k$  is implemented, this is denoted by:*

$$u_k = u_{ss} + \eta_k \quad (16)$$

**Remark 5.** *The Laguerre pole  $\gamma$  is an important tuning parameter in LPFC, which should be selected appropriately to ensure a proper input prediction. As will be seen in the next section, this offline selection is analogous to the choice of  $K$  for OFPFC.*

165

#### 4. Analysis of the two alternative modifications on integrating systems

The analysis will be split into two parts. Firstly we note that by its nature the decision making in predictive control is based on the predictions and thus, that decision making is likely to be reasonable only when the associated predictions are also reasonable. **It makes sense to look at the optimised predictions**

170

determined by PFC and overlay these with both the desired and actual closed-loop behaviour. For a good algorithm, all these plots will be similar. Secondly  
 175 we do a posteriori analysis of the resulting closed-loop poles. Again, it is of interest to ask how near these poles are to the desired pole and also, whether there is a clear dependence on choices such as the coincidence point  $n_y$ , the internal feedback gain  $K$  and the Laguerre pole  $\gamma$ ?

#### 4.1. Input prediction structure

180 The most clarity in terms of prediction consistency is given at the point where something, such as a set point, changes. At this point, it is possible to compute the optimised prediction without the non-zero initial conditions which may obscure the transparency of the core decision making. Also, for an integrator system, it is possible, a priori, to determine the nominal predicted  
 185 input sequence which would give the desired dynamics and steady-state. **Note that for convenience, as it does not affect poles and nominal behaviour, the term  $d_k$  is not included, i.e.,  $d_k = 0$  and  $G_p = G_m \triangleq G$ .**

**Lemma 2.** *The ideal input signal which would provide the desired output behaviour when controlling an integrator system, is an exponential decay with  
 190 decay rate the desired pole  $\lambda$ .*

*Proof.* For a model  $G(z)$ ,  $y(z) = G(z)u(z)$  and a target trajectory  $r(z) = R/(1 - z^{-1}) - R/(1 - \lambda z^{-1})$ , then the associated nominal input which enables the predicted output to meet the target trajectory, that is  $r(z) = y(z)$ , is given by:

$$y(z) = G(z)u(z) = \frac{R}{1 - z^{-1}} - \frac{R}{1 - \lambda z^{-1}} \Rightarrow \quad (17)$$

$$u(z) = G^{-1}(z) \frac{R(1 - \lambda)z^{-1}}{(1 - z^{-1})(1 - \lambda z^{-1})}$$

The Lemma then follows from substituting  $G(z) = \frac{bz^{-1}}{1 - z^{-1}}$  in (17) from which:

$$u(z) = \frac{R(1 - \lambda)}{b(1 - \lambda z^{-1})} \quad (18)$$

□

**Corollary 1.** *The obvious corollary of Lemma 2 is that, for an integrator system, the input predictions should comprise the form of (18).*

**Theorem 3.** *The prediction structure (12) for LPFC matches the desired structure of (18) if and only if  $\gamma = \lambda$ .*

*Proof.* For an integrator model, the steady input  $u_{ss} = 0$ . Hence eqn.(12) is presented as:

$$u(z) = \frac{\eta_k}{1 - \gamma z^{-1}} \quad (19)$$

Eqn.(19) equals to eqn.(18) if and only if  $\gamma = \lambda$  and  $\eta_k = R(1 - \lambda)/b$ .  $\square$

**Theorem 4.** *The prediction structure (11) for the implied  $u(z)$  in OFPFC matches the desired structure of (18) if and only if  $K = \frac{1-\lambda}{b}$ .*

*Proof.* Eqn.(11) can be presented as

$$u(z) = \frac{KR}{1 - z^{-1}} \cdot \frac{\lambda(1 - (1 - bK)z^{-1})}{(1 - bK)(1 - \lambda z^{-1})} \quad (20)$$

Eqn.(20) equals to eqn.(18) if and only if  $K = \frac{1-\lambda}{b}$ .  $\square$

#### 4.2. Closed-loop poles with OFPFC

Having established that the predictions used by OFPFC can be of the suitable form, it would be interesting to compute the actual closed-loop poles and find out how near these are to the desired closed-loop pole  $\lambda$ , and also the extent to which this depends upon both  $n_y$  and  $\lambda$ .

**Lemma 3.** *The closed-loop pole with OFPFC is given as:*

$$z = (1 - bK) + \frac{bK[\lambda^{n_y} - (1 - bK)^{n_y}]}{1 - (1 - bK)^{n_y}} \quad (21)$$

*Proof.* Combining control law (10) with the model  $y(z) = P(z)v(z)$  gives:

$$\begin{aligned} \left\{ z - (1 - bK) - \frac{bK[\lambda^{n_y} - (1 - bK)^{n_y}]}{1 - (1 - bK)^{n_y}} \right\} y(z) \\ = \frac{bK}{1 - (1 - bK)^{n_y}} (1 - \lambda^{n_y}) r(z) \end{aligned} \quad (22)$$

from which the result is obvious.  $\square$

**Theorem 5.** *It follows immediately from (21) that the closed-loop poles for OFPFC depend on both  $K$  and  $n_y$  and moreover, the desired closed-loop pole  $\lambda$  can only be achieved in general if  $1 - bK = \lambda$ .*

**Remark 6.** *A general point [15] is that, as  $n_y$  increases and irrespective of the choice of  $K$  (but assuming  $0 \leq 1 - bK < 0$ ), the closed-loop pole moves towards  $1 - bK$  as the power terms in (21) tend to zero.*

**Remark 7.** *It is well known that the choice of coincidence horizon  $n_y = 1$  is good for first order systems and in general allows the desired closed-loop pole  $\lambda$  to be achieved (and that is seen also in (21)) irrespective of the choice  $K$ . However, in general  $n_y = 1$  is not an option and thus we need to investigate how the closed-loop pole changes for larger  $n_y$ .*

#### 4.3. Closed-loop poles with Laguerre PFC

The reader is reminded that LPFC uses the integrator model  $G(z)$  directly for prediction but otherwise the derivation of the implied closed-loop poles is straightforward.

**Theorem 6.** *The implied closed-loop pole with model  $G(z)$  of LPFC given below is seen to depend on both  $\gamma$  and  $n_y$  and indeed have a similar structure to (21):*

$$z = 1 - (1 - \lambda^{n_y}) \frac{1 - \gamma}{1 - \gamma^{n_y}} \quad (23)$$

*Proof.* By substituting (12) to (3), the prediction into system (7) with Laguerre PFC is given as:

$$y_{k+n_y|k} = y_k + b\eta_k \frac{1 - \gamma^n}{1 - \gamma} \quad (24)$$

and the control law of LPFC is:

$$\eta_k = \frac{1 - \gamma}{b(1 - \gamma^{n_y})} (1 - \lambda^{n_y})(R - y_k) \quad (25)$$

The closed-loop transfer function is derived by substituting  $\eta_k$  into  $y_{k+1} = y_k + bu_k = y_k + b\eta_k$ , hence

$$\{z - 1 + (1 - \lambda^{n_y}) \frac{1 - \gamma}{1 - \gamma^{n_y}}\} y(z) = r(z)(1 - \lambda^{n_y}) \frac{1 - \gamma}{1 - \gamma^{n_y}} \quad (26)$$

□

**Remark 8.** *Similar conclusions apply as for LPFC: (i) if  $n_y = 1$ , the closed-loop pole is always  $\lambda$ ; (ii) for larger  $n_y$ , if  $\gamma = \lambda$ , the closed-loop pole is always at  $\lambda$  and (iii) if  $\gamma \neq \lambda$ , the closed-loop pole tends towards  $\gamma$  for high  $n_y$ .*

225 For both OFPFC and LPFC, the closed-loop pole can be forced to match the desired pole  $\lambda$  by setting the tuning parameters  $K$  and  $\gamma$  appropriately and thus the response of the closed-loop system would be equal to the desired reference trajectory.

#### 4.4. Constraints handling

230 GPC and DMC are widely applied in industry for their ability to handle constraints. For PFC, a simple method is adopted to avoid the need to solve a quadratic programming (QP) or indeed a more complex nonlinear programming (NLP) problem. As the constraints handling method for LPFC has been introduced in [18], only the proposed approach for OFPFC is discussed in this section.

235

**Theorem 7.** *Given any suitable  $K$  as the feedback gain in OFPFC, all the input constraints on  $u_k$  and the output constraints on  $y_k$  can be converted to constraints on input  $v_k$  such as:*

$$v_{min} \leq v_k \leq v_{max} \quad (27)$$

*Proof.* Assume  $u_{min} \leq u \leq u_{max}$  ( $u_{min} \leq 0 \leq u_{max}$ ), and  $\Delta u_{min} \leq \Delta u \leq \Delta u_{max}$  ( $\Delta u_{min} \leq 0 \leq \Delta u_{max}$ ). The constraints on  $v$  can be presented via eqn.(8) as:

$$\begin{aligned} u_{min} + Ky_{k+i} \leq v_{k+i} \leq u_{max} + Ky_{k+i} \\ \Delta u_{min} + K\Delta y_{k+i} \leq \Delta v_{k+i} \leq \Delta u_{max} + K\Delta y_{k+i} \end{aligned} \quad , \quad i = 0, 1, 2, \dots \quad (28)$$

The output prediction can be derived from  $y_k$  and  $v_k$ , which gives the constraints on  $v$  in a compact way:

$$\frac{u_{min}}{(1-bK)^i} + Ky_k \leq v_{k+i} \leq \frac{u_{max}}{(1-bK)^i} + Ky_k, \quad i = 0, 1, 2, \dots \quad (29)$$

$$\Delta u_{min} + K\Delta y_k + v_{k-1} \leq v_{k+i} \leq \Delta u_{max} + K\Delta y_k + v_{k-1}$$

Constraints on output such as  $y_{min} \leq y \leq y_{max}$  can similarly be presented via eqn.(9) as:

$$\frac{K(y_{min} - (1-bK)^i y_k)}{1 - (1-bK)^i} \leq v_{k+i} \leq \frac{K(y_{max} - (1-bK)^i y_k)}{1 - (1-bK)^i}, \quad (30)$$

$$i = 0, 1, 2, \dots$$

Consequently,  $v_k$  has an implied upper bound and a lower bound by considering all the inequalities in eqn.(29) and eqn.(30).  $\square$

**Remark 9.** *It is recommended to choose  $K = \frac{1-\lambda}{b}$  as the feedback gain to guarantee the perfect controller performance as discussed before. However, effective*  
 240 *constraint handling only requires that  $0 \leq 1 - bK < 1$ .*

## 5. Numerical cases and comparisons

A unit integrator system (7) (with  $b = 1$  without loss of generality) is used in section 5.1 and section 5.2. Of particular interest are the predictions deployed by the OFPFC, LPFC, PFC algorithms and their consistency with the target and  
 245 also the closed-loop poles achieved. For testing these three control strategies, the setpoint  $R$  is a simple unit step change from 0 to 1 at the first sample instant. The impact of various choices of coincidence point  $n_y$ , the internal feedback gain  $K$  and the Laguerre pole  $\gamma$  are presented and contrasted with the expected results from Section 4.

### 250 5.1. The impact of various choices for parameters of $K$ and $\gamma$ on the closed-loop behaviour

In this subsection, we plot in Fig. 3 the dependence of the closed-loop responses on the different choices of  $K$  and  $\gamma$ , but for a fixed  $\lambda$  as the same



patterns are observed regardless of  $\lambda$ . For convenience a choice of  $n_y = 5$ ,  $\lambda =$   
 255 0.7 is deployed. Some characteristics can be concluded as follows:

1. The OFPC and LPFC responses match when  $\gamma = 1 - bK$ .
2. Considering the closed-loop pole response dependence on parameter  $K$  for OFPFC, of particular note is that if the pole  $(1 - bK)$  is faster than the target  $\lambda$ , then so is the resulting closed-loop response and conversely, if  
 260 slower, likewise.
3. There is an equivalent pattern with LPFC, but this time the linking is to the choice of  $\gamma$ .
4. In both cases, the response and the target overlay **if and only if**  $\lambda = 1 - bK$  and  $\lambda = \gamma$ .

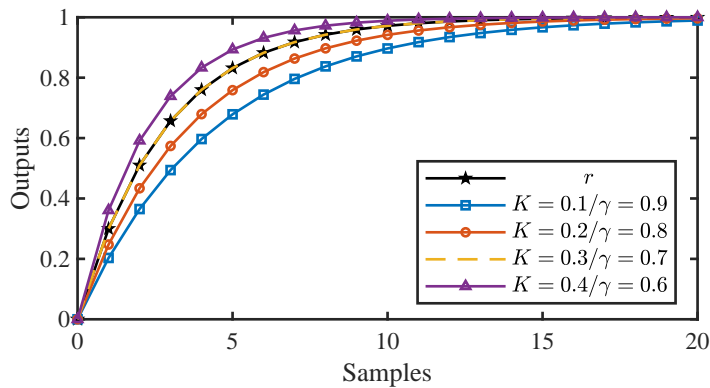

Figure 3: The outputs by OFPFC/LPFC and reference trajectories with different  $K$ s /  $\gamma$ s.

## 265 5.2. The impact of coincidence horizon $n_y$

Having established that the best choices for  $K$  and  $\gamma$  are  $\lambda = 1 - bK$  and  $\lambda = \gamma$ , next it is worth considering whether this choice is effected by the choice of coincidence horizon  $n_y$ . Fig. 4 shows the closed-loop behaviour for various choices of  $n_y$ , when  $\lambda = 0.7 = 1 - bK = \gamma$ . Only one figure is plotted here  
 270 since the outputs of OFPFC and LPFC are just the same, which confirms the expectations of Remarks 7, 8 that the closed-loop pole is independent of the choice of  $n_y$ , in this case.

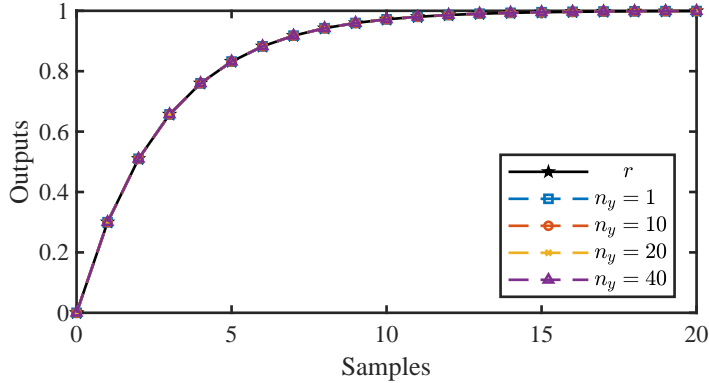

Figure 4: The outputs by OFPFC/LPFC and reference trajectories with  $n_y = 1, 10, 20, 40$ ,  $\lambda = 0.7$ .

### 5.3. Comparisons between OFPFC, LPFC and conventional PFC on higher order systems

PFC does not have the additional tuning parameter of OFPFC/LPFC and consequently the behaviour is **not** so reliable. **In this subsection, a system with more complex dynamics is used to compare and contrast the two alternative proposals OFPFC and LPFC with a conventional PFC algorithm.** Take an integrator system in series with a first-order transfer function:

$$G(z) = \frac{3z^{-1}}{1 - 1.5z^{-1} + 0.5z^{-2}} \quad (31)$$

275 Fig. 7 overlays the responses from a classic PFC with OFPFC and LPFC with a target closed-loop pole of  $\lambda = 0.7$  and  $n_y = 5$ . **Clearly, with higher order system dynamics, it is no longer reasonable to track the first order target perfectly, especially during immediate transients.** However, conventional PFC has failed to deliver even close to the desired dynamic, while attractively OFPFC has a  
 280 better performance than LPFC since the control input is adjusted on basis of not only the parameter  $K$  but also the prediction output  $y_m$ . This result also shows the potential of OFPFC to deal with the more complex dynamics.

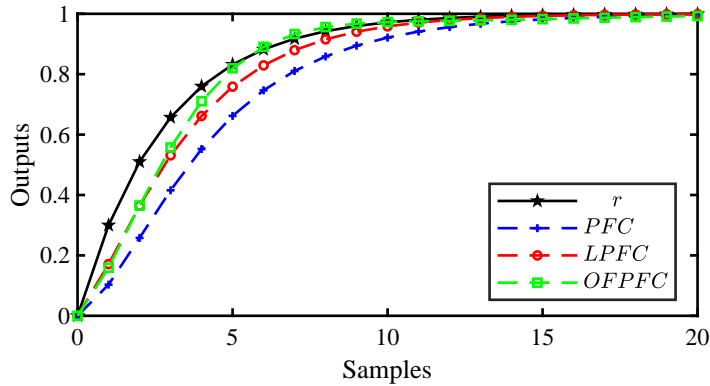

Figure 5: An integrator process system with a first-order transfer function controlled by conventional PFC, LPFC and OFPFC.

#### 5.4. An industrial case study

This section demonstrates how the proposals can be used on a more authentic industrial example. Level control is a common task in a batch process (see Fig.6); to ensure the supply is stable, the level in the cylinder needs to be maintained to a setpoint. However, the radius of cylinder increases with height, thus the level  $h$  (in  $m$ ) of the cylinder is nonlinearly related to inlet flow  $Qm^3/s$ :

$$\dot{h} = \frac{Q}{\pi(h+2)^2} \quad (32)$$

The outlet will open 10 seconds every minute for supplying material to the reactor, with  $Q_{out} = 1m^3/s$ . There is no inhalation in the inlet and the inlet flow should be greater than zero.

## NEED TO ADD SOME DETAILS OF MODELLING AND how/WHY CHOICES OF PARAMETERS

Here three different controllers: PID, output feedback PFC and conventional PFC are compared. To show a comparable result, the parameters of PID and conventional PFC have been well tuned as shown in Table 1.

The closed-loop simulations are given in Fig. 7. The sawtooth like behaviour is an inevitable consequence of the interim opening and shutting of the outlet

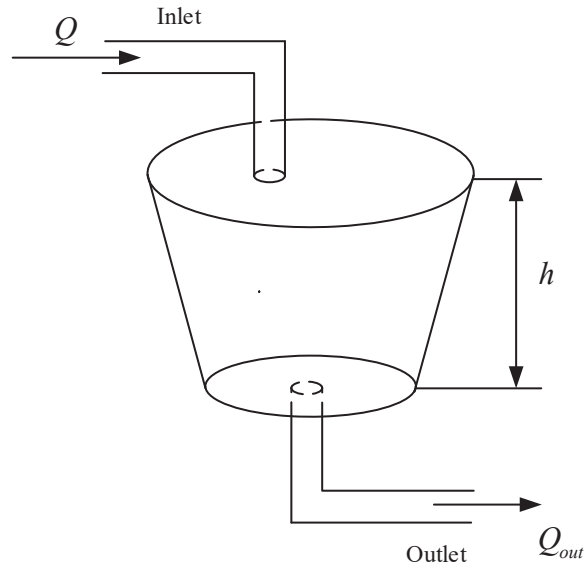

Figure 6: A tank for storing the react material. The level is effected by the inlet flow and outlet flow.

|       |                            |
|-------|----------------------------|
| PID   | $K_p = 0.1, K_i = 0.001/s$ |
| OFMPC | CLTR= 60, $n_y = 1$        |
| PFC   | CLTR = , $n_y =$           |

Table 1: Tuning parameters for industrial case study

295 valve. Moreover, as the inlet flow can only be positive ( $Q \geq 0$ ), hence once the level is over the setpoint, there are no means, except opening the outlet, to reduce the level and thus it is unsurprising if simplistic control strategies such as these three controllers all give a modest result in terms of performance. Critically however, it should be noted that the closed-loop responses of OFMPC  
 300 and conventional PFC are quite different and the settling time/responses from OFMPC are clearly the best.

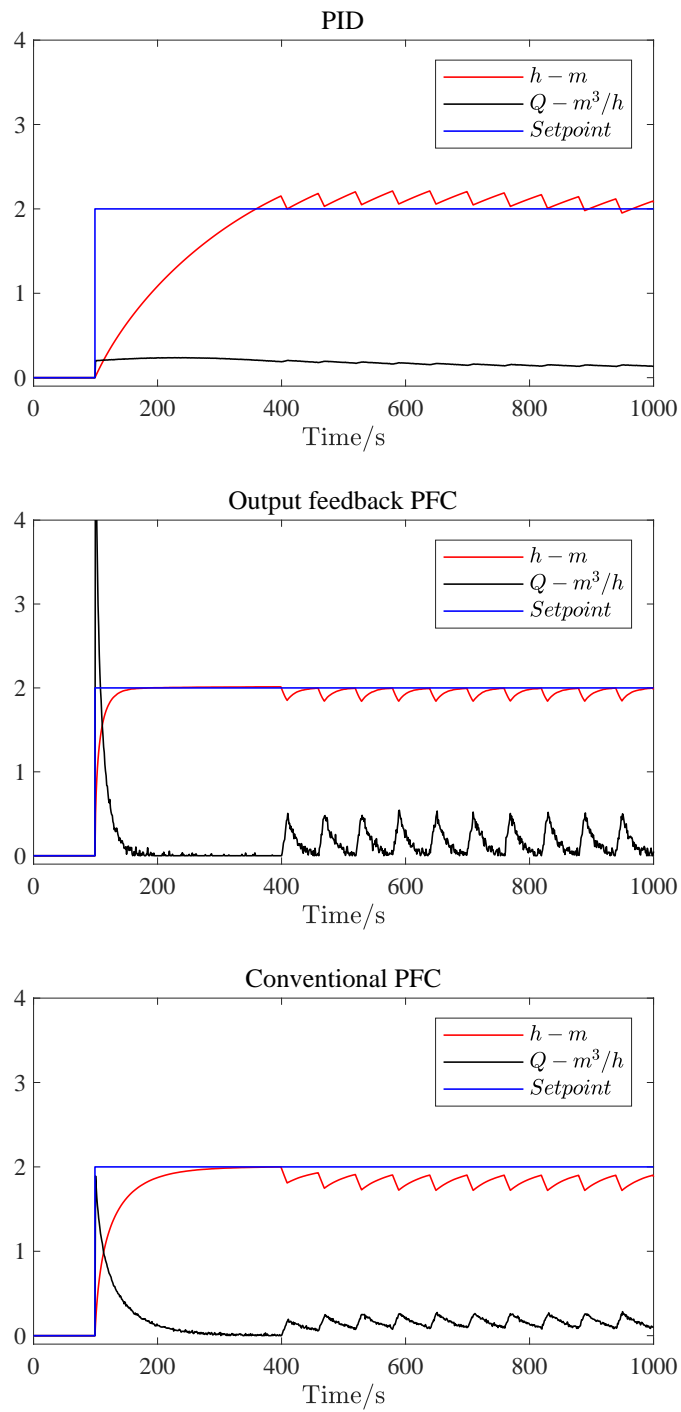

Figure 7: Level controlled by PID, OFPFC and conventional PFC.

## 6. Conclusions

The efficacy of the proposed OFPFC algorithm and an existing LPFC algorithm are considered for overcoming the challenges introduced by integrator systems to a conventional PFC approach. Careful analysis of OFPFC and LPFC is used to demonstrate that these approaches both include an additional offline tuning parameter which can be used to ensure good consistency between predictions and desired behaviour. Indeed, the paper shows the precise dependence of the implied closed-loop pole on these extra parameters, as well as the more normal choices of desired pole and coincidence horizon. These insights facilitate the proposal for systematic choices which are demonstrated, in the numerical examples, to be effective and indeed allow the exact closed-loop behaviour to be achieved for a pure integrator. **An industrial case is implemented to illustrate further the ability to handle constraints and mild nonlinearity by the OFPFC.**

Future work will be focused on the robustness and sensitivity analysis of the proposed OFPFC especially for more complex systems such as second order, non-minimum phase systems and open-loop unstable systems. In addition, some tests on real world processes will be carried out to evaluate the method further.

## Acknowledgements

This work is supported by National Natural Science Foundation of P.R.China (NO. 61621002, NO. 61374121) and Natural Science Foundation of Zhejiang, China (LR17F030002).

## References

- [1] J. Richalet, S. A. el Ata-Doss, C. Arber, H. Kuntze, A. Jacubasch, W. Schill, Predictive functional control-application to fast and accurate robots, IFAC Proceedings Volumes 20 (5) (1987) 251–258.
- [2] R. Haber, R. Bars, U. Schmitz, Predictive control in process engineering: From the basics to the applications, John Wiley & Sons, 2012.

- [3] H. Fallahsohi, C. Changenet, S. Placé, C. Ligeret, X. Lin-Shi, Predictive functional control of an expansion valve for minimizing the superheat of an evaporator, *International journal of Refrigeration* 33 (2) (2010) 409–418.
- [4] C. Changenet, J. Charvet, D. Gehin, F. Sicard, B. Charmel, Study on predictive functional control of an expansion valve for controlling the evaporator superheat, *Proceedings of the Institution of Mechanical Engineers, Part I: Journal of Systems and Control Engineering* 222 (6) (2008) 571–582.
- [5] R. Haber, U. Schmitz, K. Zabet, Implementation of pfc (predictive functional control) in a petrochemical plant, *IFAC Proceedings Volumes* 47 (3) (2014) 5333–5338.
- [6] J. Richalet, D. O’Donovan, *Predictive functional control: principles and industrial applications*, Springer Science & Business Media, 2009.
- [7] Z. Zhang, L. Xie, H. Su, Rail pressure controller design of gdi basing on predictive functional control, *Control Theory and Technology* 17 (2) (2019) 176–182.
- [8] C. R. Cutler, B. L. Ramaker, Dynamic matrix control- a computer control algorithm, in: *joint automatic control conference*, no. 17, 1980, p. 72.
- [9] D. W. Clarke, C. Mohtadi, P. Tuffs, Generalized predictive control part i. the basic algorithm, *Automatica* 23 (2) (1987) 137–148.
- [10] D. Q. Mayne, J. B. Rawlings, C. V. Rao, P. O. Scokaert, Constrained model predictive control: Stability and optimality, *Automatica* 36 (6) (2000) 789–814.
- [11] Q. ZHANG, S. WANG, Studies and applications of predictive functional control in temperature tracking of chemical reactors [j], *Control Theory & Applications* 4.
- [12] D. W. Clarke, Application of generalized predictive control to industrial processes, *IEEE Control systems magazine* 8 (2) (1988) 49–55.

- [13] J. A. Rossiter, A priori stability results for pfc, *International journal of control* 90 (2) (2017) 289–297.
- [14] J. Rossiter, *A first course in predictive control*, CRC press, 2018.
- [15] J. Rossiter, R. Haber, The effect of coincidence horizon on predictive functional control, *Processes* 3 (1) (2015) 25–45.
- 360 [16] J. Rossiter, R. Haber, K. Zabet, Pole-placement predictive functional control for over-damped systems with real poles, *ISA transactions* 61 (2016) 229–239.
- [17] J. Richalet, G. Lavielle, J. Mallet, *La commande prédictive: Mise en oeuvre et applications industrielles*, Eyrolles, 2004.
- 365 [18] M. Abdullah, J. Rossiter, R. Haber, Development of constrained predictive functional control using laguerre function based prediction, *IFAC-PapersOnLine* 50 (1) (2017) 10705–10710.
- [19] J. Richalet, D. O’Donovan, Elementary predictive functional control: A tutorial, in: *2011 International Symposium on Advanced Control of Industrial Processes (ADCONIP)*, IEEE, 2011, pp. 306–313.
- 370 [20] M. Abdullah, J. A. Rossiter, Utilising laguerre function in predictive functional control to ensure prediction consistency, in: *2016 UKACC 11th International Conference on Control (CONTROL)*, IEEE, 2016, pp. 1–6.