



This is a repository copy of *Vibration testing of a steel girder bridge using cabled and wireless sensors*.

White Rose Research Online URL for this paper:  
<http://eprints.whiterose.ac.uk/152442/>

Version: Accepted Version

---

**Article:**

Zhu, D., Wang, Y. and Brownjohn, J.M.W. (2011) Vibration testing of a steel girder bridge using cabled and wireless sensors. *Frontiers of Architecture and Civil Engineering in China*, 5 (3). pp. 249-258. ISSN 1673-7407

<https://doi.org/10.1007/s11709-011-0113-y>

---

This is a post-peer-review, pre-copyedit version of an article published in *Frontiers of Architecture and Civil Engineering in China*. The final authenticated version is available online at: <http://dx.doi.org/10.1007/s11709-011-0113-y>

**Reuse**

Items deposited in White Rose Research Online are protected by copyright, with all rights reserved unless indicated otherwise. They may be downloaded and/or printed for private study, or other acts as permitted by national copyright laws. The publisher or other rights holders may allow further reproduction and re-use of the full text version. This is indicated by the licence information on the White Rose Research Online record for the item.

**Takedown**

If you consider content in White Rose Research Online to be in breach of UK law, please notify us by emailing [eprints@whiterose.ac.uk](mailto:eprints@whiterose.ac.uk) including the URL of the record and the reason for the withdrawal request.



[eprints@whiterose.ac.uk](mailto:eprints@whiterose.ac.uk)  
<https://eprints.whiterose.ac.uk/>

# Vibration Testing of a Steel Girder Bridge using Cabled and Wireless Sensors

Dapeng Zhu <sup>1</sup>, Yang Wang <sup>1</sup>, James Brownjohn <sup>2</sup>

<sup>1</sup> School of Civil and Environmental Engineering, Georgia Institute of Technology,  
Atlanta, GA, 30332, USA

<sup>2</sup> Department of Civil and Structural Engineering, The University of Sheffield,  
Sheffield, S1 3JD, UK

## Abstract

Being able to significantly reduce system installation time and cost, wireless sensing technology has attracted much interest in the structural health monitoring (SHM) community. This paper reports the field application of a wireless sensing system on a 4-span highway bridge located in Wayne, New Jersey in the US. Bridge vibration due to traffic and ambient excitation is measured. To enhance the signal-to-noise ratio, a low-noise high-gain signal conditioning module is developed for the wireless sensing system. Nineteen wireless and nineteen cabled accelerometers are first installed along the sidewalk of two neighboring bridge spans. The performance of the wireless sensing system is compared with the high-precision cabled sensing system. In the next series of testing, sixteen wireless accelerometers are installed under the deck of another bridge span, forming a  $4 \times 4$  array. Operating deflection analysis is successfully conducted using the wireless measurement of traffic and ambient vibrations.

**Keyword:** wireless sensing, structural health monitoring (SHM), signal conditioning, operating deflection analysis, ambient vibration.

## 1. Introduction

As civil structures are continuously subjected to various adverse operational and environmental conditions, their safety conditions may deteriorate quickly. For example, more than one fourth of the bridges in the United States have been categorized as structurally deficient or functionally obsolete (ASCE 2009). To ensure public safety, US Federal Highway Administration requires that inspection to a typical bridge is conducted once every two years. However, the current practice is mainly visual inspection, which is subjective and labor intensive. Besides, visual inspections can only identify damage that is visible on the structural surface; internal damage often remains neglected by the inspectors.

As a complimentary approach to visual structural inspections, structural health monitoring (SHM) systems have been widely explored for measuring the response of large-scale civil structures (Farrar, Sohn *et al.* 2003; Ko and Ni 2005). The measurement data is used for identifying subtle structural abnormality. In an SHM system, various types of sensors, such as accelerometers, strain gauges, thermometers, displacement and velocity transducers, can be used for monitoring structural behavior. A data acquisition (DAQ) system usually collects all the sensor measurement at a central server. Traditionally, cabled connections are used between sensors and the central server. The high cost and time consumption associated with cable installation are among various factors that hinder the wide-spread adoption of SHM systems. For example, the cost of installing a typical structural monitoring system in a mid-rise building can exceed a few thousand dollars per sensing channel (Celebi 2002). In addition, extensive lengths of cables can consume over 75% of the total installation time for a cabled SHM system (Straser and Kiremidjian 1998).

In order to overcome the difficulties associated with cable installation, wireless SHM systems are developed by exploiting latest advances in micro-electro-mechanical systems (MEMS) and wireless communication (Straser and Kiremidjian 1998). MEMS and wireless technology lead to the development of smart, low-cost, miniaturized wireless sensing nodes that are capable of collecting sensor data and wirelessly transmitting data without the need of cables. To be considered as a potential substitute for conventional cabled SHM systems, it is necessary to validate the performance of wireless SHM systems. To date, a number of academic and commercial prototypes have been proposed and tested in the laboratory (Spencer, Ruiz-Sandoval *et al.* 2004; Liu, Yuan *et al.* 2005; Lynch and Loh 2006). However, only in recent years have researchers begun testing wireless SHM systems in field applications. For example, Lynch *et al.* (2004) validated the performance of a prototype wireless sensor on the Alamosa Canyon Bridge in southern New Mexico. Kim *et al.* (2007) reported a large-scale deployment of wireless accelerometers on the Golden Gate Bridge in San Francisco. Rice *et al.* (2010) tested the Imote2 wireless SHM system on a full-scale cable-stayed bridge in South Korea. In addition, the wireless SHM platform designed by Wang *et al.* (2007) has been successfully validated on a number of bridge structures (Lynch, Wang *et al.* 2006; Wang, Loh *et al.* 2006; Weng, Loh *et al.* 2008).

Some challenges associated with wireless sensing systems have been reported in the literature. For example, the low vibration amplitude of a civil structure under ambient excitations can present difficulties for the data sampling of analog sensor signals. In addition, long transmission range is usually required in the field, which makes reliable wireless communication more challenging. One approach to address the transmission range issue is through multi-hopping with relatively short-range wireless transceivers, and the other approach is to use single-hop with relatively long-range transceivers; both have pros and cons. Under scenarios where significant obstruction cannot be penetrated by the wireless signal, multi-hopping through relay units can potentially circumvent the obstruction. On the other hand, reliable multi-hopping requires more complicated middleware implementation on the wireless

sensing units; relaying data through multiple wireless sensing units also causes greater communication latency. Furthermore, all relaying nodes along the hopping path have to consume some amount of battery power for transmitting a single packet.

This paper investigates the field performance of a prototype wireless sensing unit, namely the Narada system (Swartz, Jung *et al.* 2005; Zimmerman, Shiraishi *et al.* 2008). A highway bridge located in Wayne, New Jersey, USA, is selected as the testbed structure. The Narada wireless sensing unit provides four 16-bit high resolution analog-to-digital-conversion (ADC) channels. A low-noise high-gain signal conditioning module is developed for filtering and amplifying the low-amplitude vibration signal. In addition, the Narada unit contains a power-amplified version of a commercial wireless transceiver, which achieves a long communication range in the field without consuming a significant amount of battery power. Benefiting from this special modification of the wireless transceiver, a simple yet robust single-hop wireless network is adopted in this field study. High-gain antennas are used in the field application to further improve communication reliability. The performance of the wireless system is first validated by baseline measurement from a high-precision cable-based system. The wireless sensing nodes are then deployed at a different configuration for capturing the operating deflection shapes of a bridge span.

The rest of the paper is organized as follows. Section 2 begins with the description of the wireless SHM system, including the wireless sensing unit and the specially designed signal conditioning module. In Section 3, the testbed highway bridge is first introduced, followed by the first setup for field testing. The wireless SHM system and the baseline cabled SHM system are both installed at same measurement locations along the sidewalk of two bridge spans. Measurement data from the wireless and cabled SHM systems are compared. Section 4 first describes the second setup for field testing, where the wireless sensors are distributed at the deck of another bridge span. Operating deflection shapes are extracted from the wireless data. Section 5 provides some summary and discussion.

## 2. Wireless and cable-based SHM systems

This section first describes the wireless sensing system, including the Narada wireless sensing unit and a low-noise high-gain signal conditioning module that is specially designed for low-amplitude vibration signals. The cable-based SHM system is then briefly introduced.

### 2.1 Narada wireless sensing unit and signal conditioning module

The Narada wireless sensing unit (Swartz, Jung *et al.* 2005; Zimmerman, Shiraishi *et al.* 2008) is developed for both SHM and structural control applications. The design of the Narada wireless sensing unit mainly consists of four modules: sensing interface, computational core, wireless transceiver, and control signal generation. The main component of the sensing interface is a 4-channel 16-bit analog-to-digital converter

(ADC), Texas Instruments ADS8341. The ADC is capable of sampling and digitizing analog signal from various sensors. The digitized sensor data is then transferred to the computational core, where data can be processed by an ATmega 128 microcontroller and stored in a 128-KB external memory. A special power-amplified version of the Chipcon CC2420 transceiver operating at the 2.4 GHz frequency band is adopted for wireless communication. The nominal wireless data rate is 250 kbps, and the maximum communication range in open space is over 500 meters. In addition to SHM, the Narada wireless unit also supports real-time feedback control for civil structures (Swartz and Lynch 2009). The major component of the control signal generation module is a 2-channel 12-bit digital-to-analog converter (DAC), Texas Instruments DAC7612. The DAC can generate analog signals as command input for semi-active control devices, such as magnetorheological (MR) damper, for feedback structural control applications.

The Silicon Designs 2012 accelerometer, with a frequency range of DC-300 Hz, is adopted for wireless sensing. The measurement range is  $\pm 2g$ , and the sensitivity is 1V/g, where  $g$  is gravitational acceleration. When the vibration is weak, the accelerometer signal amplitude is low and susceptible to circuit noise. To alleviate aliasing effect during analog-to-digital conversion, a low-noise high-gain signal conditioning module (Figure 1) is developed for filtering and amplifying sensor measurement prior to ADC. The signal conditioning module consists of a high-pass filter with a cutoff frequency of 0.014Hz and a low-pass 4<sup>th</sup>-order Bessel filter with a selectable cutoff frequency of 25Hz or 500Hz. The phase shift introduced by a Bessel filter varies linear with frequency, which is equivalent to a constant time delay to the signals within the pass band (Horowitz and Hill 1989). This special property helps to maintain the waveform in time domain. In addition, the 4<sup>th</sup>-order provides reasonable steepness in the frequency response function for effectively eliminating high-frequency noises. The amplification gain of the signal conditioning module can be easily adjusted to 2, 20, 200, or 2000. In this study, the cutoff frequency of the low-pass filter is set to 25 Hz, and the amplification gain is set to 20.

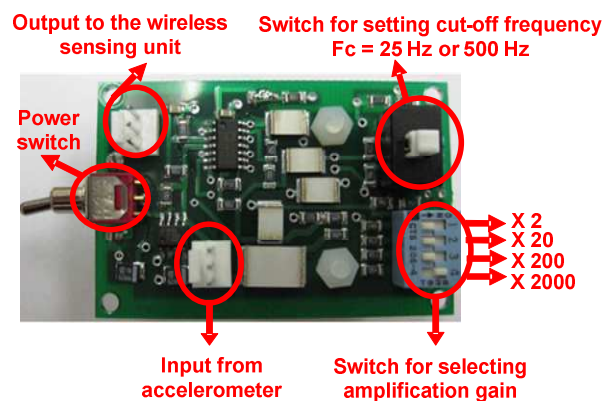

Figure 1. High-gain signal conditioning board (6.1cm  $\times$  4.1cm)

## 2.2 The cable-based SHM system

The Honeywell QA750 accelerometer is adopted in the cable-based system. Table 1 provides the performance comparison of the Honeywell QA750 cabled accelerometer and Silicon Designs 2012 wireless accelerometer. Available at a relatively low price, the Silicon Designs accelerometer has a higher noise floor and lower measurement range, yet is more convenient for deployment due to the low requirement on power supply. A 32-channel 24-bit Data Physics Mobilyser spectrum analyzer collects cabled accelerometer time-history data and computes cross spectra and transfer functions, for subsequent modal analysis. The cable-based system uses multichannel signal cables for connection with color-coded individual sensor cables. High-standard connectors and lightweight rigid sensor mounts are used to minimize signal noise and loss problems, so that data recovery is maximized during short-time testing.

Table 1. Parameters of the accelerometers used by the cabled and wireless systems.

<b>Specification</b>	<b>Honeywell QA750 (Cabled system)</b>	<b>Silicon Designs 2012 (Wireless system)</b>
Sensor Type	Servo Force Balance	Capacitive
Measurement Range	$\pm 30g$	$\pm 2g$
Bandwidth	DC to $>100Hz$	DC to $300Hz$
Noise Floor	$\sim 0.1\mu g/\sqrt{Hz}$	$26\mu g/\sqrt{Hz}$ (single-ended output)
Power Supply	$\pm 13V$ to $\pm 18V$	$+5V$

## 3. Comparison between wireless and cabled data

In this section, the testbed bridge structure is first introduced. The field testing setups of the wireless and cabled systems are then described, followed by the comparison between wireless and cabled data.

### 3.1 Description of the highway bridge (US202 & NJ23, Wayne, New Jersey, US)

The testbed highway bridge was built in 1983 and is located on NJ 23 freeway over US route 202 in Wayne, New Jersey, US. Figure 2 shows the schematic of the highway bridge. The bridge consists of two nominally separate superstructures for southbound and northbound traffic. Each direction has four lanes and a sidewalk, and each direction comprises four separated spans of multiple simply supported steel girders. Reinforced concrete piers support the spans via bearings. Figure 3 shows the view of northbound spans #1 and #2 from the east side of the bridge.

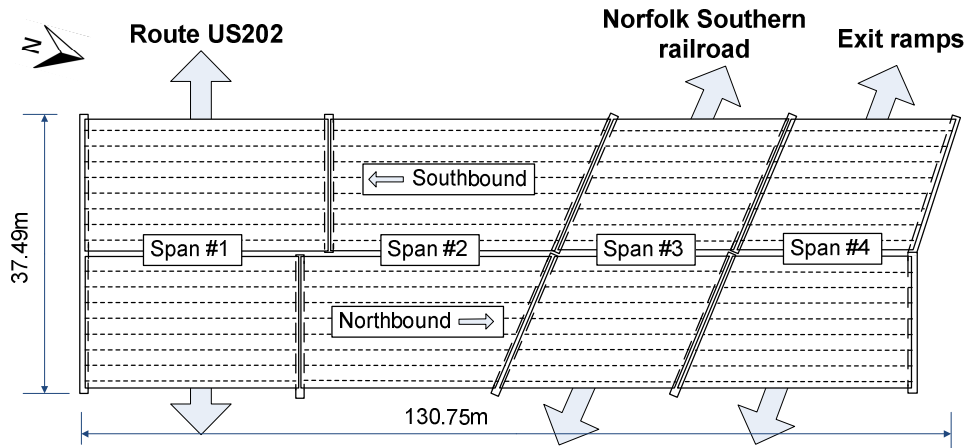

Figure 2. Schematic of the highway bridge (US 202 & NJ 23, Wayne, New Jersey, US)

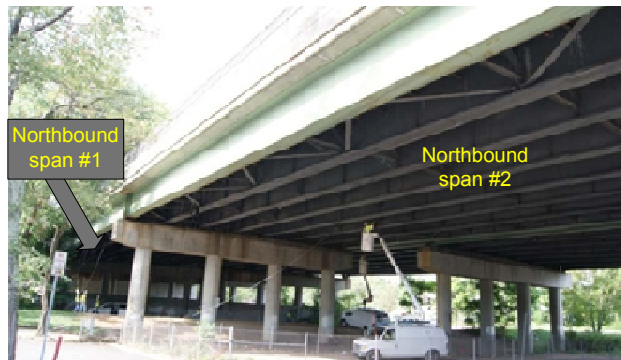

Figure 3. Picture of spans #1 and #2 (view from the eastside of the bridge)

### 3.2 Experimental setup on the northbound sidewalk

Nineteen pairs of wireless and cabled accelerometers are first instrumented along the sidewalk of the northbound spans #1 and #2 (Figure 4). Each accelerometer measures acceleration along the vertical direction. Due to safety concerns, traffic is closed for the lane next to the sidewalk and remains open for other three northbound lanes. Figure 5(a) shows a picture of the sidewalk. Each cabled accelerometer is connected to the data acquisition (DAQ) system on the ground level underneath the bridge (Figure 5(b)), which requires running cables along the sidewalk and feeding the cables down to the ground level. Most of the efforts for setting up the cabled system were spent on securely laying out the cables.

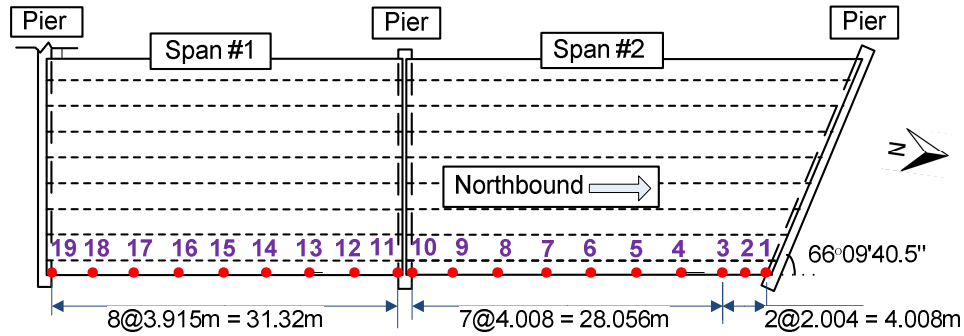

Figure 4. Deployment of 19 pairs of cabled and wireless accelerometers on the northbound sidewalk.

The wireless server is allocated on the ground level at the east side of the bridge, as shown in Figure 5. In this study, the longest distance between the wireless server and the wireless sensing node is about 40m. Directional antennas (6 dBi Intellinet 525138, Figure 5(a)) are adopted at the wireless unit side, and a 7 dBi omni-directional antenna (Buffalo WLE-HG-NDC, Figure 5(b)) is used at the wireless server side. For better communication with the server, the 6dBi antenna for each wireless unit is elevated off the sidewalk and attached to the metal safety net (Figure 5(a)). For better communication, each directional Intellinet antenna at the wireless unit side is carefully aligned so that they face the Buffalo antenna at the server side. The antenna alignment and wireless signal searching consumed the majority of the efforts for setting up the wireless system.

To ensure the measurement axis to be along the vertical direction, each pair of cabled and wireless accelerometers are placed on the same level plate, as shown in Figure 5(c). One Silicon Designs 2012 accelerometer and one signal conditioning module are associated with each Narada wireless sensing unit. A waterproof package is used to contain the Narada wireless unit, the signal conditioning module, and a battery pack, while the accelerometer and the 6 dBi antenna remain outside the package (Figure 5(d)). During data collection, the sampling rates of the wireless system and cabled system are set as 100Hz and 256Hz, respectively.



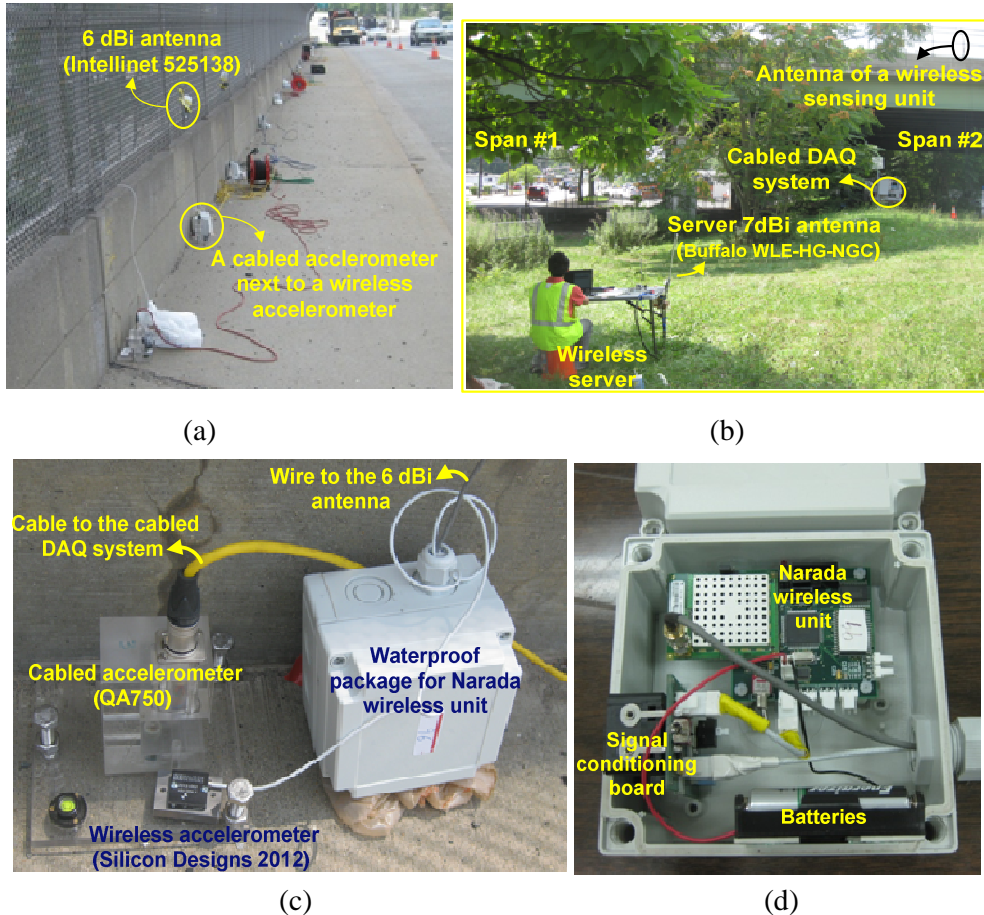

Figure 5. Pictures of the deployment on northbound sidewalk: (a) Wireless and cabled sensors on the northbound sidewalk; (b) Wireless server and cabled DAQ system at the east side of the bridge; (c) Cabled and wireless accelerometers; (d) Inside view of the waterproof package of a wireless sensing unit.

### 3.3 Traffic and ambient vibration measurement on the northbound sidewalk

Traffic and ambient vibration measurement is conducted on the sidewalk during daytime. Figure 6 presents example acceleration time histories recorded at locations #6, #10, and #15, as well as the corresponding power spectral density (PSD) plots for both wireless and cabled data. Figure 7 shows close-up comparison of acceleration time histories at locations #6 and #10. A 0.1 ~ 15 Hz bandpass digital filter has been applied to all data sets so that signal in the same frequency range is compared. Note that sensor location #10 is close to piers where the vibration is weak, while locations #6 and #15 are near the middle of a span, where the vibration is relatively strong.

Both figures illustrate excellent agreement between the data sets collected by the wireless and cabled systems, at each measurement location. Figure 7 particularly shows that the two sets of time histories are almost indistinguishable by eye.

Because there is no common time base between the cabled and wireless systems, the acceleration plots are shifted along the time axis for the best match. Nevertheless, once the time shift between the two systems is identified, the same constant shift is applied to plots at all locations. Therefore, with the cabled data well synchronized among all locations, close agreement between the wireless and cabled data also indicates the excellent time synchronization among the wireless data at different locations. The cabled and wireless PSD plots in Figure 6 are also very similar, except for the very-low frequency range at location #10, where the signal-to-noise ratio is low. The high-quality Honeywell QA750 accelerometer and the larger sampling frequency used by the cabled system probably contribute to the more accurate measurement for this most challenging frequency band. Overall, although the cost of the wireless SHM system (including the accelerometers and the data acquisition units) is lower, it is demonstrated that the system is capable of providing high-quality measurements that are comparable with the cabled system.

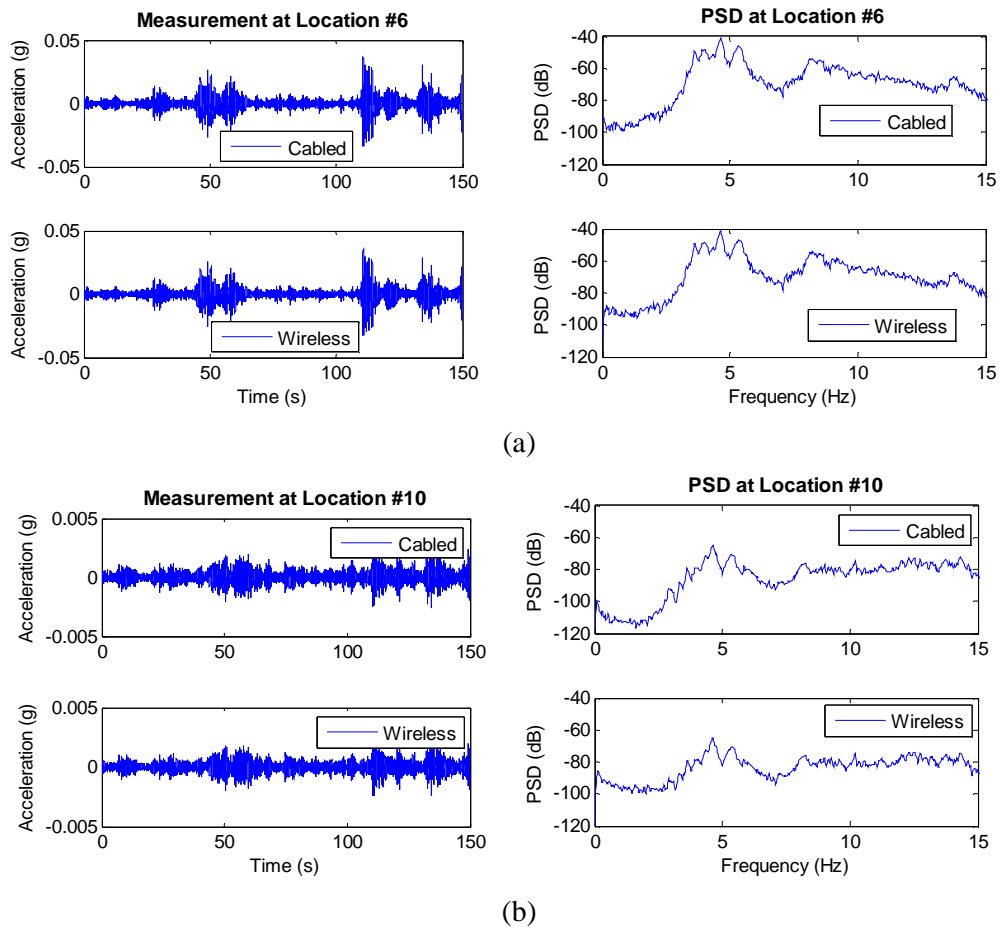

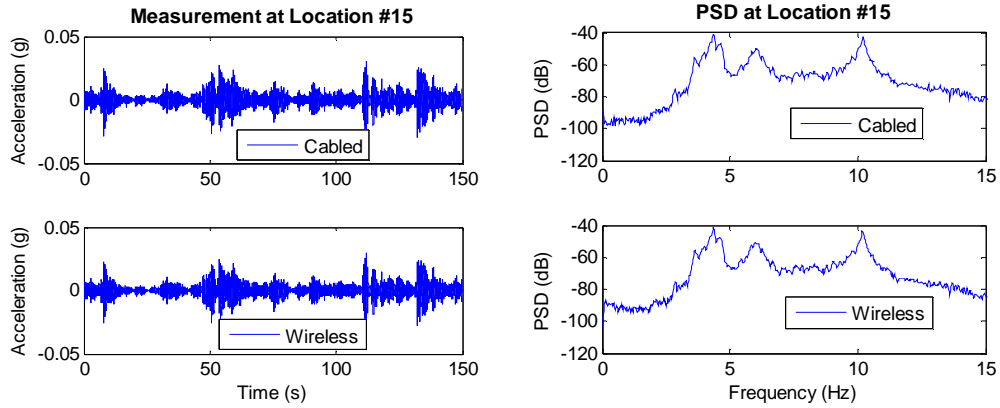

(c)

Figure 6. Comparison of acceleration time histories and PSD plots between cabled and wireless systems deployed on northbound sidewalk (deployment shown in Figure 5): (a) Location #6; (b) Location #10; (c) Location #15

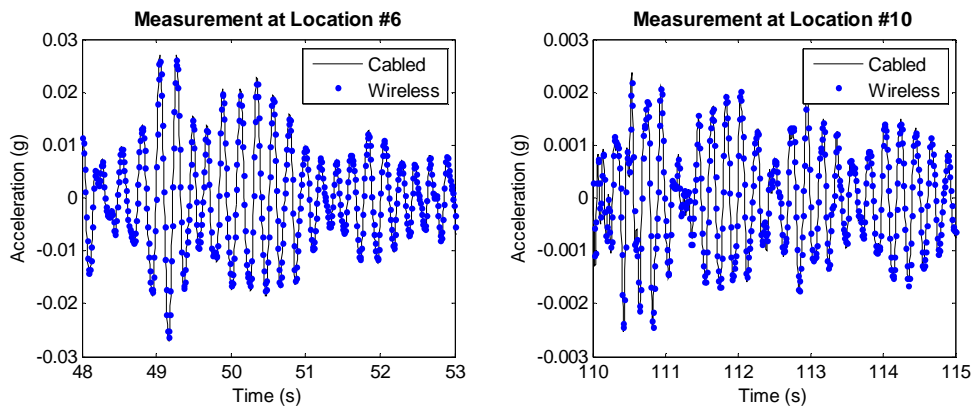

Figure 7. Close-up view of five seconds of overlaid acceleration data collected by the cabled and wireless systems at locations #6 and #10.

#### 4. Operating deflection analysis using wireless sensor data

This section first introduces the experimental setup of the wireless SHM system on southbound span #2. The measurement results are then presented, followed by the operating deflection shapes extracted from the wireless data.

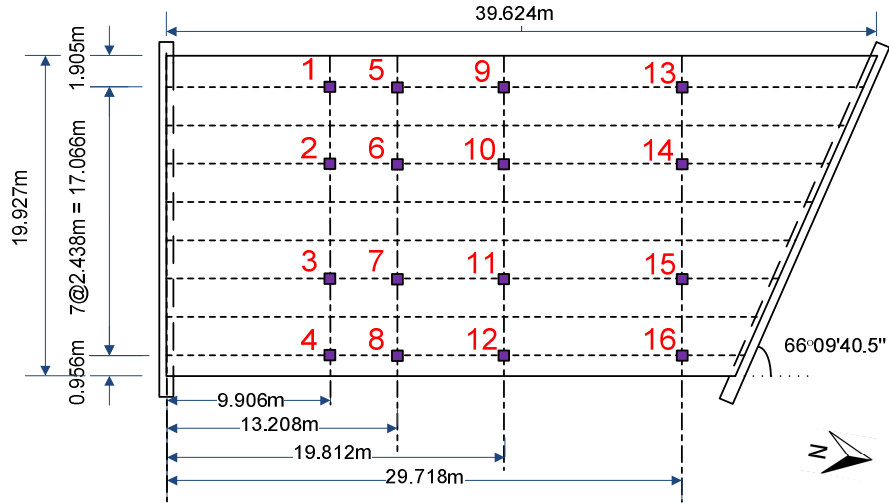
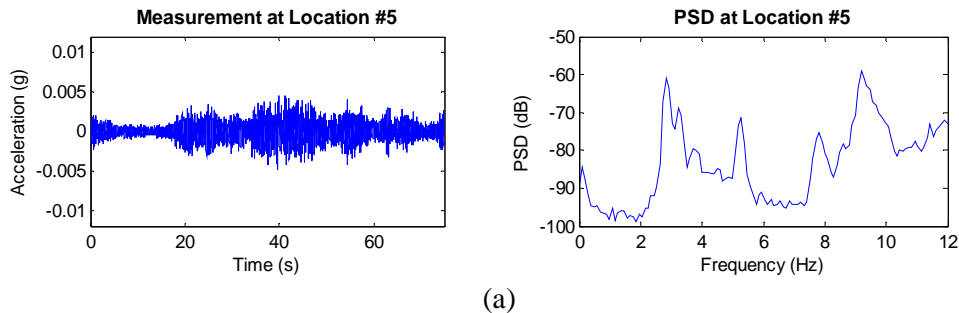

Figure 8. Deployment of wireless sensing nodes on southbound span #2

#### 4.1 Experimental setup on the southbound span #2

In the next series of measurements conducted at nighttime, 16 Narada wireless sensing nodes are installed on the girders (under the deck) of southbound span #2 and form a  $4 \times 4$  array (Figure 8). The wireless server is located on the ground level under northbound span #2. Traffic and ambient vibrations are recorded by the wireless sensing system at a sampling rate of 200Hz. The reason for selecting 200 Hz sampling frequency is to further alleviate aliasing effect, in addition to the 4<sup>th</sup>-order Bessel filter in the signal conditioning board. Although the relatively high order of the filter provides adequate steepness at its cutoff frequency, as an analog circuit, the filter response is always causal and the steepness can never be ideal. Therefore, a higher sampling frequency can further enhance the anti-aliasing performance, particularly in case of a low signal-to-noise ratio. Figure 9 shows example acceleration time histories recorded at locations #5, #10, and #15, as well as corresponding power spectral density (PSD) plots. In contrast to Figure 6, it is shown that the vibration amplitude is much lower at nighttime.



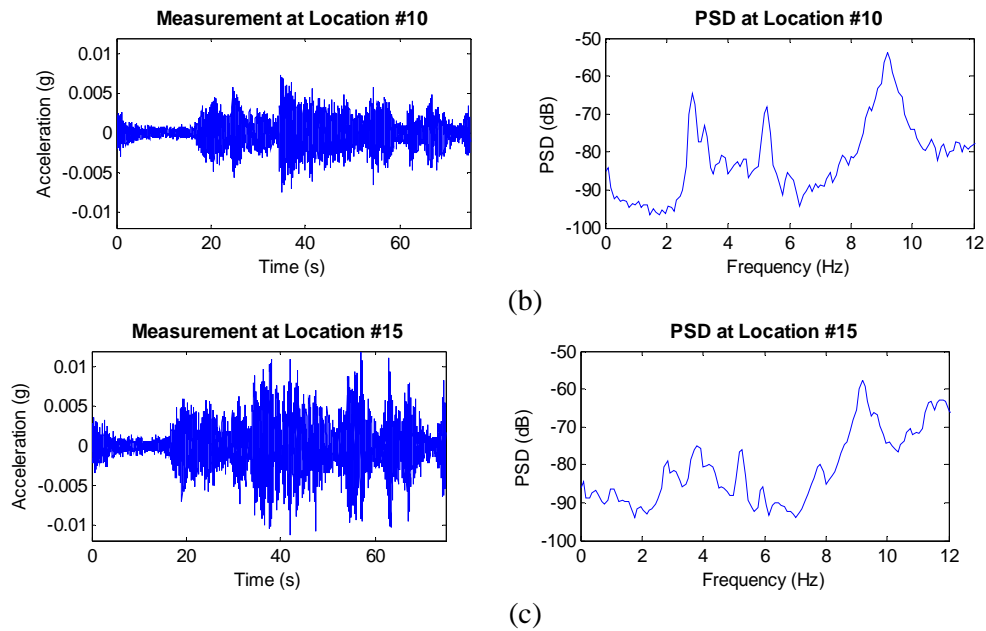
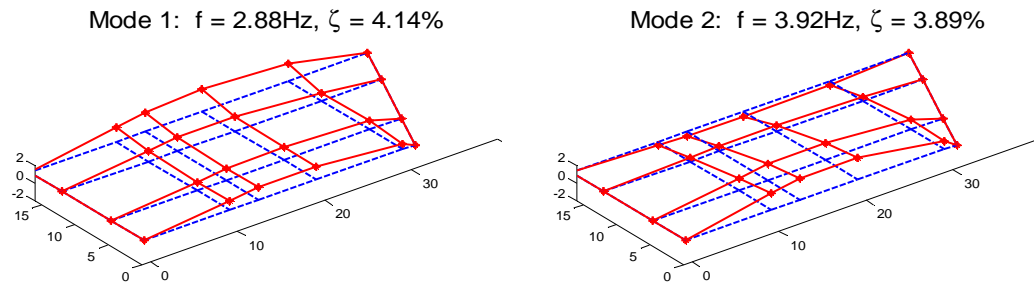

Figure 9. Acceleration time histories and PSD plots of wireless measurement on southbound span #2 (deployment shown in Figure 8): (a) Location #5; (b) Location #10; (c) Location #15.

#### 4.2 Operating deflection analysis using wireless data on southbound span #2

Operating deflection analysis is conducted using the acceleration time histories recorded by the wireless sensors. The natural excitation technique (NExT) (Farrar and James 1997) and eigensystem realization algorithm (ERA) (Juang and Pappa 1985) are applied on the wireless data to extract the vibration modes. Figure 10 shows the first four operating deflection shapes of southbound span #2. The four resonance frequencies in Figure 10 match well with the peaks in the PSD plots of Figure 9. The first mode shape shows all nodes moving along one direction, which is expected for such a simply supported span. With increasing complexities, the other three modes also agree with typical behavior of this type of structures.



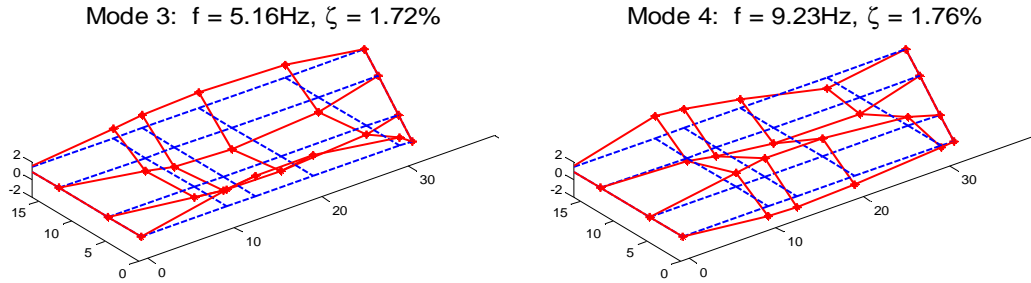

Figure 10. First four operating deflection shapes of southbound span #2

## 5. Summary and discussion

This research studies the vibration monitoring of a testbed highway bridge using both wireless and cabled sensors. To achieve higher signal-to-noise ratio for the wireless sensor, low-noise high-gain signal conditioning modules are developed to filter and amplify accelerometer signal. The wireless and cabled accelerometers are first installed side by side along the sidewalk of northbound spans #1 and #2, for measuring traffic and ambient vibrations. The acceleration time histories and power spectral density plots are compared between wireless system and cabled system, illustrating that the wireless data achieves comparable quality to the cabled data. In the next series of testing, the wireless sensing nodes are moved to southbound span #2 and form a 4×4 array. Operating deflection analysis of the bridge deck is successfully conducted using the wireless data.

While this study only focuses on short-term deployment of a wireless SHM system, further efforts can be dedicated to long-term monitoring applications. Weather-proof packaging and power supply will be the main issues in the long-term deployment. Furthermore, higher density measurement locations can be conveniently achieved by roving limited number of wireless sensing nodes through a structure, so that various model updating and damage detection algorithms can be conducted at high spatial resolutions, for evaluating more detailed structural conditions.

## 6. Acknowledgements

This research is partially sponsored by the National Science Foundation, under grant number CMMI-0928095 (Program Manager: Dr. Shih-Chi Liu). The authors appreciate the generous assistance with the field testing provided by researchers from Drexel University, including Prof. Franklin L. Moon, Prof. A. Emin Aktan, Dr. Yun Zhou, Mr. John Prader, Mr. Jeff Weidner, among others. In addition, the authors appreciate the help with the Narada wireless sensing units from Prof. Jerome P. Lynch and Dr. Andrew T. Zimmerman of the University of Michigan, as well as Prof. R. Andrew Swartz of Michigan Technological University.

## References

- [1] ASCE. Report Card for America's Infrastructure, American Society of Civil Engineers. Reston, VA, 2009.
- [2] Celebi M. Seismic Instrumentation of Buildings (with Emphasis on Federal Buildings), Report No. 0-7460-68170, United States Geological Survey. Menlo Park, CA, 2002.
- [3] Farrar C R and James G H. System identification from ambient vibration measurements on a bridge. *Journal of Sound and Vibration*, 1997, 205(1): 1-18.
- [4] Farrar C R, Sohn H, Hemez F M, Anderson M C, Bement M T, Cornwell P J, Doebling S W, Schultze J F, Lieven N and Robertson A N. Damage Prognosis: Current Status and Future Needs, Report No. LA-14051-MS, Los Alamos National Laboratory. Los Alamos, NM, 2003.
- [5] Horowitz P and Hill W. *The Art of Electronics*. London, Cambridge University Press, 1989.
- [6] Juang J N and Pappa R S. An eigensystem realization algorithm for modal parameter identification and modal reduction. *Journal of Guidance Control and Dynamics*, 1985, 8(5): 620-627.
- [7] Kim S, Pakzad S, Culler D, Demmel J, Fenves G, Glaser S and Turon M. Health monitoring of civil infrastructures using wireless sensor networks. *Proceedings of the 6th International Conference on Information Processing in Sensor Networks (IPSN '07)*, Cambridge, MA. 2007: 254-263.
- [8] Ko J M and Ni Y Q. Technology developments in structural health monitoring of large-scale bridges. *Engineering Structures*, 2005, 27(12): 1715-1725.
- [9] Liu L, Yuan F G and Zhang F. Development of wireless smart sensor for structural health monitoring. *Proceedings of SPIE, Smart Structures and Materials 2005: Sensors and Smart Structures Technologies for Civil, Mechanical, and Aerospace Systems*, San Diego, CA. 2005: 176-186.
- [10] Lynch J P, Law K H, Kiremidjian A S, Carryer E, Farrar C R, Sohn H, Allen D W, Nadler B and Wait J R. Design and performance validation of a wireless sensing unit for structural health monitoring applications. *Structural Engineering and Mechanics*, 2004, 17: 393-408.
- [11] Lynch J P and Loh K J. A summary review of wireless sensors and sensor networks for structural health monitoring. *The Shock and Vibration Digest*, 2006, 38(2): 91-128.
- [12] Lynch J P, Wang Y, Loh K J, Yi J-H and Yun C-B. Performance monitoring of the Geumdang Bridge using a dense network of high-resolution wireless sensors. *Smart Materials and Structures*, 2006, 15(6): 1561-1575.
- [13] Rice J A, Mechitov K, Sim S H, Nagayama T, Jang S, Kim R, Spencer B F, Agha G and Fujino Y. Flexible smart sensor framework for autonomous structural health monitoring. *Smart Structures and Systems*, 2010, 6(5-6): 423-438.
- [14] Spencer B F, Jr., Ruiz-Sandoval M E and Kurata N. Smart sensing technology: opportunities and challenges. *Structural Control and Health Monitoring*, 2004, 11(4): 349-368.

- [15] Straser E G and Kiremidjian A S. A Modular, Wireless Damage Monitoring System for Structures, Report No. 128, John A. Blume Earthquake Eng. Ctr., Stanford University, Stanford, CA, 1998.
- [16] Swartz R A, Jung D, Lynch J P, Wang Y, Shi D and Flynn M P. Design of a wireless sensor for scalable distributed in-network computation in a structural health monitoring system. Proceedings of the 5th International Workshop on Structural Health Monitoring, Stanford, CA. 2005.
- [17] Swartz R A and Lynch J P. Strategic network utilization in a wireless structural control system for seismically excited structures. Journal of Structural Engineering, 2009, 135(5): 597-608.
- [18] Wang Y, Loh K J, Lynch J P, Fraser M, Law K H and Elgamal A. Vibration monitoring of the Voigt Bridge using wired and wireless monitoring systems. Proceedings of the 4th China-Japan-US Symposium on Structural Control and Monitoring, Hangzhou, China. 2006.
- [19] Wang Y, Lynch J P and Law K H. A wireless structural health monitoring system with multithreaded sensing devices: design and validation. Structure and Infrastructure Engineering, 2007, 3(2): 103-120.
- [20] Weng J-H, Loh C-H, Lynch J P, Lu K-C, Lin P-Y and Wang Y. Output-only modal identification of a cable-stayed bridge using wireless monitoring systems. Engineering Structures, 2008, 30(7): 1820-1830.
- [21] Zimmerman A T, Shiraishi M, Swartz R A and Lynch J P. Automated modal parameter estimation by parallel processing within wireless monitoring systems. Journal of Infrastructure Systems, 2008, 14(1): 102-113.