



This is a repository copy of *Scheduling of grid tied battery energy storage system participating in frequency response services and energy arbitrage*.

White Rose Research Online URL for this paper:  
<https://eprints.whiterose.ac.uk/143032/>

Version: Accepted Version

---

**Article:**

Nejad, S., Mantar Gundogdu, B., Gladwin, D. et al. (1 more author) (2019) Scheduling of grid tied battery energy storage system participating in frequency response services and energy arbitrage. *IET Generation, Transmission and Distribution*, 13 (14). pp. 2930-2941. ISSN 1751-8687

<https://doi.org/10.1049/iet-gtd.2018.6690>

---

This paper is a postprint of a paper submitted to and accepted for publication in *IET Generation, Transmission and Distribution* and is subject to Institution of Engineering and Technology Copyright. The copy of record is available at the IET Digital Library.

**Reuse**

Items deposited in White Rose Research Online are protected by copyright, with all rights reserved unless indicated otherwise. They may be downloaded and/or printed for private study, or other acts as permitted by national copyright laws. The publisher or other rights holders may allow further reproduction and re-use of the full text version. This is indicated by the licence information on the White Rose Research Online record for the item.

**Takedown**

If you consider content in White Rose Research Online to be in breach of UK law, please notify us by emailing [eprints@whiterose.ac.uk](mailto:eprints@whiterose.ac.uk) including the URL of the record and the reason for the withdrawal request.



[eprints@whiterose.ac.uk](mailto:eprints@whiterose.ac.uk)  
<https://eprints.whiterose.ac.uk/>

BATTERY STORAGE PLANTS, ENERGY BALANCE SERVICE, ENERGY MARKET

## Scheduling of Grid Tied Battery Energy Storage System Participating in Frequency Response Services and Energy Arbitrage

B. Mantar Gundogdu\*, D. T. Gladwin, S. Nejad, and D. A. Stone

Department of Electronic and Electrical Engineering, University of Sheffield, Sheffield, S1 4DE, UK

\*bmantar1@sheffield.ac.uk

**Abstract:** Battery energy storage systems (BESS) are widely used to smooth power fluctuations and maintain the voltage and frequency of the power feeder at a desired level. The National Grid Electricity Transmission (NGET), the primary electricity transmission network operator in the UK, has introduced various frequency response services that are designed to provide a real-time response to deviations in the grid frequency. In this study, a control algorithm is developed which generates a charge/discharge power output with respect to deviations in the grid frequency and the requisite service specifications. Using historical UK electricity prices, a new balancing service scheduling approach has also been developed to maximize energy arbitrage revenue by layering different types of balancing services throughout the day. Simulation results show that the proposed algorithm delivers both dynamic and non-dynamic firm frequency response (FFR) and also enhanced frequency response (EFR) to NGET specifications while generating arbitrage revenue as well as service availability payments in the balancing market. A comparative study is also presented to compare the yearly arbitrage revenue obtained from the work presented in this paper and a previous reference study. Finally, experimental results of a grid-tied 2MW/1MWh BESS have been used for verification purposes.

### 1. Introduction

In recent years, an increasing power demand, near exhaustion of fossil fuels and their hazardous influence on environment, has led to an increased penetration of renewable energy sources (RESs) into the utility grid [1]-[2]. The energy obtained from such sources is environment friendly, however, the power and voltage obtained from these sources differs with variations in weather [2]. Integration of RESs into power system grids causes numerous issues such as optimum power flow, power system stability, quality, reliability, voltage/frequency control, load dispatch and system economics. During the last decade the nature of RESs power variations and the impact on the grid frequency regulation has gained increasing research interest. Significant frequency deviations can result in over/under frequency protection relays disconnecting generation and load units. Under unfavourable conditions even a small number of disconnected units could cause a cascade failure and system frequency collapse [3]-[4].

#### 1.1. Motivation

Balancing the active power between the demand and generation to maintain the grid frequency is one of the major challenges of integrating the increased intermittent RESs into the power grid. Momentary imbalance between the produced power and consumed power can cause frequency deviation of a power system. In order to ensure grid frequency stability, frequency regulation through matching the demand and supply is essential in the operating electricity markets [5]. Energy Storage Systems (ESSs) are being introduced to assist with these issues. ESSs can provide many advantages to the generation, transmission and distribution systems such as ancillary services and energy arbitrage. There are several types of ESSs for providing grid applications, such as pumped hydroelectric storage, flywheel, compressed air, fuel cell and hydrogen energy storage system [6]. Amongst ESSs,

battery energy storage systems (BESSs) tend to be the preferred option for grid scale applications as they offer a rapid active power response for both import and export, which at scale can compensate for the fluctuations generated by RESs and demand usage [1]. With the appropriate control scheme, grid scale BESS can mitigate the above challenges whilst improving system stability, quality and reliability [7]. The BESS unit imports energy when the system frequency is above a nominal value and exports this energy back into the grid when the frequency is below the nominal value [8]. Furthermore, BESS can provide a wide spectrum of applications ranging from short term power quality support (e.g. frequency regulation, voltage support) to long term energy management (e.g. energy arbitrage, peak shaving). The capital cost of battery storage technologies is continuing to fall, thus, prompting new studies for its applications and economic benefits [9].

When connecting RES to power systems, their contribution to system inertia must be considered. Addition of non-synchronous generation to a power system inherently decreases the system inertia; this may result in increased amount of rate-of-change-of-frequency (ROCOF) and larger grid frequency excursions. Therefore, system operators are required to consider altering their grid frequency control methods to avoid high rates of frequency deviation and large frequency excursions [10]. To overcome these issues, balancing markets have been introduced and utilised to ensure the security of grid frequency regulation with a minimal cost model based on the electricity market tendering schemes [11]. The National Grid Electricity Transmission (NGET), the main distribution network operator in the UK, has introduced various frequency response products, such as Firm Frequency Response (FFR) and a new fast frequency response, called Enhanced Frequency Response (EFR), with the aim of maintaining the system frequency within limits to 50 Hz under normal operation [12]-[13]. For providing such

services to the grid, the BESS is well suited due to its ability to rapidly respond to import/export demands.

In the UK, a limited number of grid-tied BESS have been installed for delivering grid scale applications. A 2.5 MW/5MWh lithium iron phosphate ESS based in Darlington provides commercial ancillary services and load shifting to the power grid [15]. A 6MW/10MWh lithium-nickel ESS based in Leighton Buzzard provides frequency support, load shifting, peak shaving and arbitrage applications to the grid [15]. In 2013, the UK's first grid-tied lithium-titanate BESS; the Willenhall Energy Storage System (WESS), was installed by the University of Sheffield to enable research on large scale batteries and to create a platform for research into grid ancillary services such as fast frequency response [13], [16]. The emergence of wholesale electricity markets in the UK, together with significant increases in prices, and price volatility of electricity have raised interest in economic opportunities for electrical energy storage [17]. One of the main profit streams for energy storage (ES) is temporal arbitrage opportunity obtained by price volatility in the wholesale market. Energy arbitrage refers to the participation of ES in the day-ahead energy market and it involves utilizing ES to benefit from electricity price fluctuations by charging during low-price periods, discharging during high-price periods, while profiting from the price differential [18]-[19]. ES can also generate revenue through the delivery of ancillary services such as grid frequency regulation [20].

The aim of this paper is to investigate two applications for BESS, grid frequency regulation and energy arbitrage in day-ahead spot markets, and how they can be scheduled in a complimentary way such that revenues are maximised whilst meeting service compliance. There are several papers in literature that investigate energy management for ESS participating in grid frequency support and/or energy arbitrage which are reviewed in the next section.

### 1.2. Literature Review and Contribution

Numerous research studies around the world have been carried out to investigate the participation of large scale ESS in power grid and frequency regulation services [12]-[13], [21]. [3] presents the concerns of the integration of new renewable power generation in power systems with a grid frequency regulation perspective. The study also covers a comprehensive overview on recent developments in the area of grid frequency regulation. Energy management is a term that has several meanings. In this paper, we focus on an optimized utilization of the available stored energy in a grid-tied BESS operating in grid frequency regulation services. In literature, there are various research works that have dealt with the energy management issue in grid scale energy storage systems and also control strategies for grid-tied BESS operating in frequency regulation with regard to different points of functionality and objectives [14]. Several methods in the smart grid environment have been developed to optimally manage the energy flowing on the smart system. [22]-[23] presented a novel optimisation method of energy cost reduction in smart grid applications to include real-time electricity pricing and energy management. Basaran *et al.* [24] introduced a novel power management strategy by designing a wind-PV hybrid system to operate both as a grid-tied system and an autonomous system. The proposed management unit

implements measurements from various points in the system, providing an effective energy transfer to batteries, loads and the grid. Considering the cost of batteries, adopting an effective charge/discharge management strategy for the efficient use of the battery in order to achieve a high state-of-charge (SOC) and prolong battery lifetime is essential [25]. Gundogdu *et al.* [13] presented a novel energy management strategy that enabled grid-tied BESS to provide bi-directional power in response to changes in the grid frequency, whilst managing the SOC of the BESS to optimise utilisation of available energy and the availability of the system. The study also presented a strategy to generate additional revenues from ancillary services such as triad avoidance.

In literature, there are also many papers relating to the energy arbitrage application [26-31]. Sioshansi *et al.* [17] presented one of the leading studies on energy arbitrage that analysed four key aspects of the economic value of electricity storage in the Pennsylvania New Jersey Maryland (PJM) markets; the basic relationship among storage energy capacity, storage efficiency and the arbitrage value of energy storage; the accuracy of theoretical ES dispatch and the value of arbitrage using perfect foresight of future electricity prices; the temporal and regional variation in the value of energy arbitrage, investigating natural gas price variations, transmission constraints and fuel mixes on energy storage economics. The impact of larger storage devices, investigating how the use of ES can decrease on-peak hourly prices and increase off-peak hourly prices diminishing the value of arbitrage, while producing welfare effects for generators and consumers. In comparison with this study [17], the focus of this paper is related to not only energy arbitrage, but also the scheduling of grid balancing services such as frequency response for additional benefit. In contrast to other recent studies in the field, the main contribution of this study is to present a dynamic firm frequency response (DFFR) control algorithm that enables BESSs to deliver dynamic power in response to deviation in the grid frequency. A static high (SFFR-high) and low (SFFR-low) frequency response control algorithm is demonstrated to deliver a non-dynamic power if the grid frequency reaches a certain high and low threshold. In addition, by using the historical electricity price profiles, a novel grid balancing service scheduling method is developed to achieve maximum energy arbitrage revenues that can be generated from the grid balancing services by layering EFR, DFFR, SFFR-high and SFFR-low throughout the day. The proposed approach will not only provide an arbitrage revenue, but will also generate further income through balancing service availability payments, which maximizes the system's profitability and availability. It should be noted that the previous study [1] presented FFR control methodologies and also a basic arbitrage control algorithm. This paper extends the study as follows:

- In [1], the energy arbitrage scenarios (only 9 scenarios) in the service scheduling method were forecasted for a specific day (14 April 2014) of spring by using its historic electricity price profile. The methodology was not expanded to look at other days of different seasons in different years. However, in this paper, the UK daily electricity price pattern has been forecasted by observing the real electricity price of several week/weekend days and also their grid frequency profiles, and then

considering this pattern the service scheduling method has been improved with 18 different arbitrage scenarios by analysing various week/weekend days of each season for a year. This provides a robust and reliable forecasting service layering technique for maximizing arbitrage revenue. This paper also demonstrates that arbitrage strategies can be forecasted which prevent losses while maximising profits in favourable seasons.

- This paper also covers experimental validation of the FFR control algorithm used in the proposed scheduling method with a 2MW/1MWh lithium-titanate BESS, commissioned and operated by the University of Sheffield, which is the largest research only platform for grid-tied energy storage applications in the UK.

## 2. FFR Service Requirements

In order to manage the grid system frequency within the normal operating range 49.5 Hz to 50.5 Hz, National Grid (NG) relies on balancing service providers to adjust their active power output or consumption in order to minimise the imbalance between demand and generation on the system. The extent of the required adjustment is determined by the system frequency deviation from 50 Hz [32]. Therefore, NG purchases balancing services to manage the grid frequency. The FFR is a frequency response service for grid balancing that can supply a minimum of 1 MW active power within a frequency deviation. FFR is open to all parties that can prequalify against the service requirements. This service is a proportional or continuous modulation of demand and generation. The FFR service can be either dynamic or static. In dynamic FFR (DFFR), power changes proportional to system frequency and in static FFR (SFFR), a set power level is delivered at a defined frequency and remains at the set level for an agreed period [33].

## 3. FFR Design Control Algorithm

A BESS model is developed in MATLAB/Simulink and verified against experimental operation of the WESS. Three new FFR control algorithms, including a DFFR algorithm, SFFR high and low frequency response control algorithms are then implemented in the model independently to deliver a grid frequency response service to the recently published NGET firm frequency response service specifications [32], [33], [34], [35], [41].

### 3.1. Dynamic Firm Frequency Response Control

In this section, a control algorithm has been developed to meet the DFFR service specifications required by NGET, as described in Table 1. Fig. 1 shows the proposed DFFR control scheme implemented in the BESS model in MATLAB/Simulink, where the inputs are real-time grid frequency (Freq) and battery SOC (SOC<sub>init</sub>), with the output being the requested import/export power (InverterPowerOutput) to deliver a frequency response according to the service specification. The algorithm starts by detecting the position of the measured frequency with respect to the zones bounded by frequency values 'A' to 'R' in Table 1 (left column). This is achieved by the 'FFR service Power vs Frequency Setpoint' green block, where the required DFFR response envelope is calculated as a function of the limits given with their values in Table 1 (left and middle column).

The calculation method of the proposed DFFR power envelope is described in the final column of the table. The required DFFR power is zero within the DB. In this work, battery SOC is calculated using equation (1). The coulomb-counting SOC estimation method is shown in the light blue block in Fig. 1. Finally, using the output, being the requested import/export power (InverterPowerOutput) to deliver a frequency response according to the service specification, the import and export energy (kWh) are calculated in the blue block in Fig. 1.

$$SOC_{out} = SOC_{init} + \frac{\int_0^t P_{batt} dt}{3600 \cdot Q} \quad (1)$$

**Table 1** DFFR power vs frequency envelope limits [33] and calculation of power set-points (CPower) in algorithm.

Freq. (Hz)	Contracted Power (kW)	CPower (kW)
A=49.5	a= 1025	a
B=49.6	b= 820	$\left[\frac{B-f}{B-A}\right]x(a-b) + b$
C=49.7	c= 615	$\left[\frac{C-f}{C-B}\right]x(b-c) + c$
D=49.8	d= 410	$\left[\frac{D-f}{D-C}\right]x(c-d) + d$
E=49.9	e= 205	$\left[\frac{E-f}{E-D}\right]x(d-e) + e$
F=49.984	f= 33	$\left[\frac{F-f}{F-E}\right]x(e-f) + f$
G=49.985	g= 0	g=0
H=50	h= 0	h= 0
J=50.015	j= 0	j= 0
K=50.016	k= -33	$\left[\frac{K-f}{K-J}\right]x(j-k) + k$
L=50.1	l= -205	$\left[\frac{L-f}{L-K}\right]x(k-l) + l$
M=50.2	m= -410	$\left[\frac{M-f}{M-L}\right]x(l-m) + m$
N=50.3	n= -615	$\left[\frac{N-f}{N-M}\right]x(m-n) + n$
P=50.4	p= -820	$\left[\frac{P-f}{P-N}\right]x(n-p) + p$
R=50.5	r= -1025	r

DFFR is a continuously delivered service that is used to respond to the second-by-second grid frequency changes. Energy storage providers must respond to changes in nominal grid frequency by decreasing or increasing their import/export power. A dead-band (DB) is defined where there is no requirement to import/export power to the grid but there is also no opportunity to charge/discharge the battery to manage its state-of-charge (SOC). Providers must deliver continuous import/export power as detailed in the DFFR service envelope in Table 1. The power level must remain within this required envelope at all times; power provided outside the envelope will decrease the service performance measurement (SPM) and hence the income revenue [32]. The operation principle of the proposed BESS charge/discharge management for delivering DFFR service (yellow block in Fig. 1) is detailed in the reference study [1]. According to the logic of the DFFR control algorithm, BESS can only import/export power, with respect to the NGET required DFFR power envelope described in Table 1, to respond to grid frequency changes outside of DB ( $\pm 0.015$ Hz).

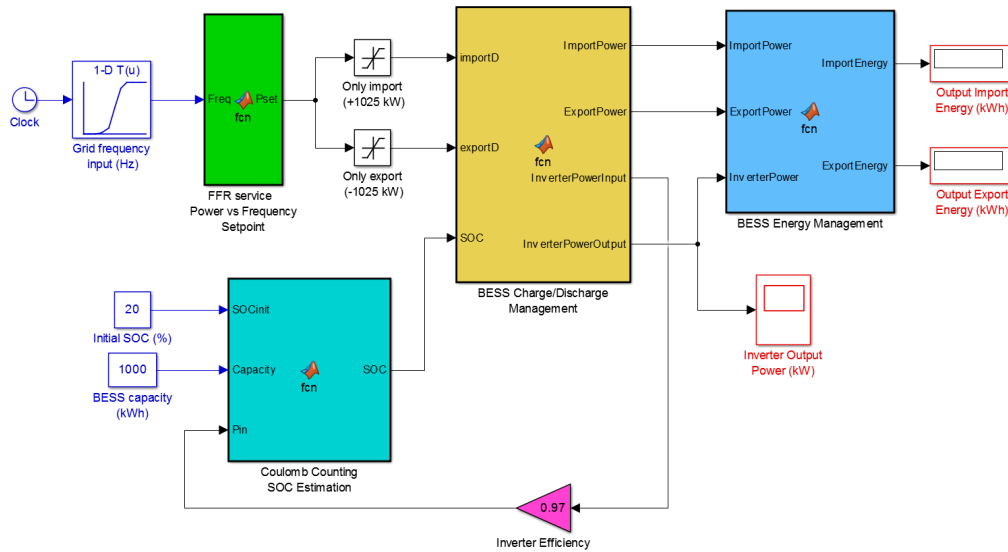

Fig. 1 DFFR algorithm implemented in the BESS model in Matlab/Simulink.

### 3.2. Static Firm Frequency Response Control

SFFR delivers a non-dynamic service where an agreed amount of power (1 MW) is delivered if the grid frequency reaches a certain trigger point. The service providers monitor the grid frequency and adjust their generation or consumption power when the frequency goes below the specified frequency trigger (e.g. 49.7 Hz or 50.3 Hz). The previous study [1] has the logic of the low and high SFFR services respectively, where the system must maintain a power output for 30 minutes. The NG specify a high reset frequency (50.3 Hz) and low reset frequency (49.7Hz) [32], [34]. The aim of the resets is to discontinue the frequency response if the grid frequency changes sharply for the period of the service.

According to the proposed BESS management for SFFR<sub>low</sub> shown in [1], when the frequency drops below the low trigger frequency ( $f_{low}$ ), the BESS starts to deliver a maximum power response ( $S_{Power} > 0$ ) until the grid frequency goes back above the specified high trigger frequency ( $f_{high}$ ); the response continuation must not be interrupted until it reaches the trigger reset or 30 minutes. The logic is reversed for SFFR<sub>high</sub> control algorithm [1]. According to the proposed BESS management for SFFR<sub>high</sub>, when the frequency goes above the high trigger frequency ( $f_{high}$ ), the BESS starts to import a maximum power response ( $S_{Power} < 0$ ) until the grid frequency goes back below the specified low trigger frequency ( $f_{low}$ ); the response continuation must not be interrupted until it reaches a trigger reset or a time length of 30 minutes.

### 4. Simulation Results of the FFR Algorithms

All the FFR control algorithms are simulated in MATLAB/Simulink using a real frequency data set obtained from the NG [35]. The simulation results presented in this section are all based on a 1 MW/1 MWh BESS model, which has been experimentally validated on the WESS plant in the UK [16] with a maximum FFR power of  $\pm 1$  MW. It should be noted that although WESS is rated at 2 MW it is not capable of delivering for 30 minutes at constant power due to

a capacity limitation under 1 MWh. The parameters used in the BESS model with FFR control algorithms are shown in Table 2.

In order to show the performance of the reported FFR control algorithms in Section 3, the historical frequency data for the 11<sup>th</sup> November 2015 (first 3 hours) [35] is used herein, as this particular day is known to have both a low and high frequency event. Fig. 2 shows the simulation results of the DFFR control algorithm. On the frequency plot, the DB ( $\pm 0.015$  Hz) is shown by the green lines. It is clear from Fig. 2, the BESS continuously imports/exports power within the specified power envelope described in Table 1. Fig. 6.b illustrates the power response versus grid frequency plot of DFFR control algorithm for 12 October 2016. The red line represents the NGET required DFFR power line described in Table 1. It is clear that the DFFR power (blue circles) does remain within the required envelope, meaning that the BESS achieved 100% availability and met the service requirements. Fig. 3 and Fig. 4 show the simulation results for 11<sup>th</sup> Nov 2015 of the SFFR low and high frequency response control algorithms, respectively. On the frequency plots, the high and low trigger reset frequency set points are shown by the dotted green lines.

Table 2 Parameters used in the BESS model.

Parameter	Value
Nominal frequency	50 Hz
Low/high DB	$\pm 0.015$ Hz (for DFFR)
High/low trigger frequency	$\pm 0.3$ Hz (for SFFR)
Max/min FFR power limit	$\pm 1$ MW
Battery power/capacity for FFR	1 MW/1 MWh
Battery power/capacity for EFR	2 MW/1 MWh
Battery initial SOC ( $SOC_{init}$ )	20%

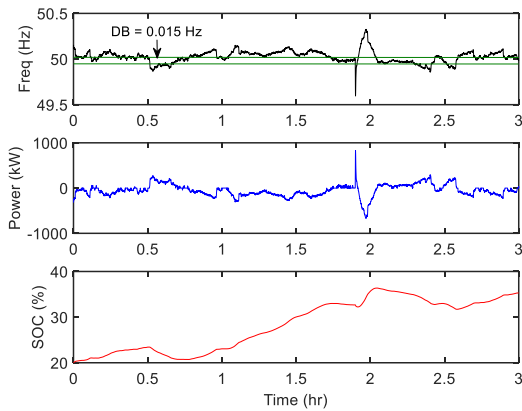

**Fig. 2** Simulation results of the DFFR control algorithm implemented in BESS for 11th Nov 2015 (first 3 hours): Frequency, power and battery SOC plots.

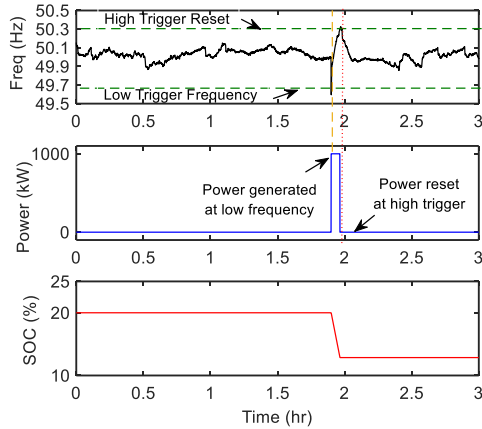

**Fig. 3** Simulation results of the SFFRlow control algorithm implemented in BESS for 11th Nov 2015 (first 3 hours).

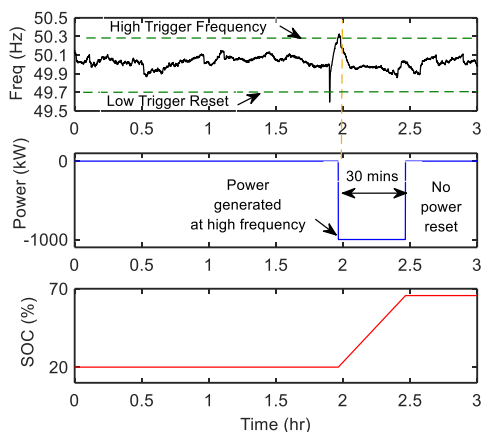
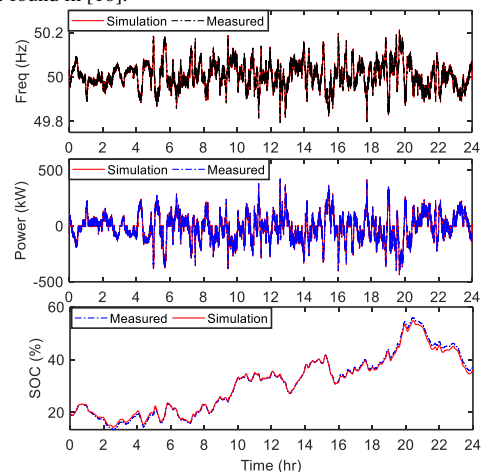

**Fig. 4** Simulation results of the SFFRhigh control algorithm implemented in BESS for 11th Nov 2015 (first 3 hours).

Over the 3-hour profile the algorithms deliver to the SFFR<sub>low</sub> and SFFR<sub>high</sub> specification [32], [34] with no power being delivered until a frequency event occurs at 49.7 Hz and 50.3 Hz, respectively. As seen from the simulation results of the SFFR<sub>low</sub> algorithm (Fig. 3), the grid frequency drops below 49.7 Hz, the BESS starts to export 1 MW power response until the frequency goes back above 50.3 Hz (trigger reset). As seen from the results of SFFR<sub>high</sub> control algorithm in Fig. 4, as the grid frequency goes above 50.3 Hz, BESS starts to import 1 MW power response for 30 minutes. The aim of the resets in the SFFR control algorithms is to discontinue the frequency response if the grid frequency changes sharply for the period of the service. Since there is no trigger reset here (Fig. 4), the power response must continue for 30 minutes.

**5. Experimental Verification with Willenhall ESS**

The UK's first grid-tied lithium-titanate (LTO) type of battery, Willenhall ESS, was commissioned in 2015 by the University of Sheffield (UoS). The facility comprises a 1 MWh, 2 MW Toshiba LTO battery, interfaced to the power grid through 11 kV feed at the Willenhall Primary Substation in the UK. It aims to investigate the characteristics of an LTO type battery, as well as different battery chemistries, for delivering grid support functions at scale [38]-[39]. An LTO battery is used in WESS due to its superior performance in terms of long cycle life, safety and rapid recharging capability. The battery storage is made up of 40 parallel-connected racks, each consisting of 22 series-connected battery modules, and each module consists of 24 battery cells in a 2P12S formation [13]. There are 21,120 cells in the DC battery unit with a total capacity of approximately 1 MWh. The battery storage is connected to a four quadrant DC/AC 2 MVA converter which converts a variable battery DC voltage to grid AC voltage. The basic structure of WESS consist of a 1 MWh capacity of battery unit (DC storage), PCS100 ESS Converter (2 MW) which allows active/reactive power control based on the system requirement, an isolated transformer (2.1 MVA) which connect the power converter to the 11 kV AC grid. More technical details on the WESS can be found in [16].



**Fig. 5** Comparison of the experimental and simulation results obtained on DFFR Model for 12 Oct 2016.

In this paper, to experimentally validate the performance of the proposed DFFR control algorithm used in the service scheduling method, WESS was utilized as a test bed. Fig. 5 and Fig. 6 compares the results attained from the developed DFFR model and the real 1 MW/1 MWh BESS, responding to grid frequency deviations through the DFFR service for 24-hour operation period for 12 Oct 2016. The figure shows that the DFFR model is representative of the real system with a RMSE of 0.71% and 29.5 kW and MAPE of 0.5% and 3% for SOC and power, respectively (Table 4). The sampling time is 25ms in the WESS controller and MATLAB model, it can be observed from the Fig. 5 that there is a slight shift between the measured and simulated grid frequency due to the sampling time error (RMSE frequency error of 0.0136 Hz). This unmatched frequency causes a significant error in battery SOC over time due to differing power outputs. In addition, small discrepancies can be accounted from the increased losses in the WESS experimental system when compared to the MATLAB model. The WESS inverters have increased losses when operating at very low power (<100kW),

this is evident in the night time period of the power and SOC plots (Fig. 5). Table 3 shows the energy flow findings of the proposed DFFR control algorithm for a 1 MW/1 MWh BESS.

**Table 3.** Energy output findings of the DFFR control algorithm and the experimental WESS for 12 Oct 2016.

DFFR	Import (kWh)	Export (kWh)
Measured	1052	792.5
Simulation	1048	779

**Table 4.** Comparison of error findings from the developed DFFR and EFR control algorithms.

Error	Algorithm	Frequency (Hz)	SOC (%)	Power (kW)
RMSE	EFR <sup>(a)</sup> [13]	-0	0.19	25.8
Error	DFFR	0.0136	0.71	29.5
MAPE	EFR [13]	-0	0.31	4.5
Error (%)	DFFR <sup>(b)</sup>	0.027	0.5	6

(a) 21 Oct 2015 (first 12-hour frequency data)  
 (b) 12 Oct 2016 (24-hour frequency data)

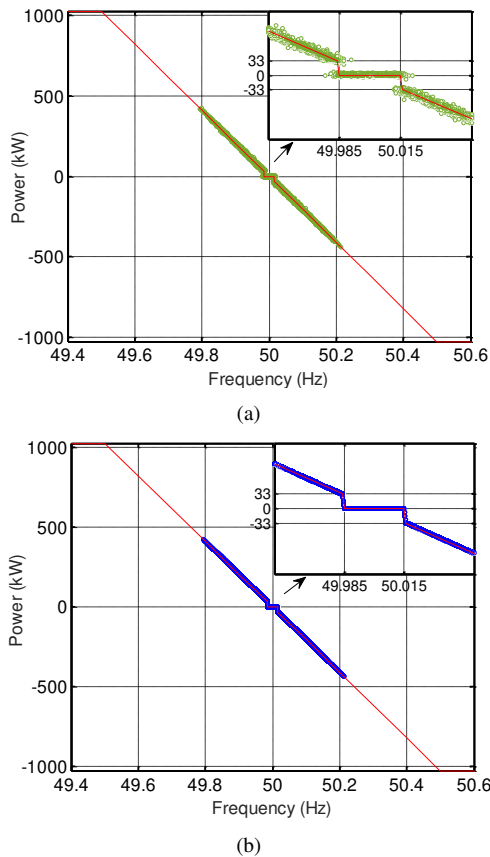

**Fig. 6** Power versus frequency plot (a) measured (b) simulation using DFFR Model for 12 Oct 2016.

As seen from the table, the import and export energy output difference between measured and simulated is low (import of 4 kWh and export of 13.5 kWh), this indicates that the simulated DFFR control algorithm is representative of real world operation. The power versus frequency plot of the experimental WESS and simulated BESS model for 12 Oct 2016 is shown in Fig. 6, respectively. The red line represents the NGET required DFFR power line. It can be seen that the FFR power (blue circles) does remain within the envelope and hence this does not cause a penalty in SPM. Comparing the power versus frequency plots in Fig. 6a and b, the power obtained from the experimental WESS poses significant noises comparing the simulated one. In [13] by the authors, the EFR control algorithm, which will be used in the proposed service scheduling algorithm in this paper Section 6 and Section 7, has been experimentally validated using the 2 MW/1 MWh WESS, with <4.5% and ~0.3% of MAPE against simulated power and battery SOC for the 12-hour period in 21st October 2015 (Table 4). The following sections use the experimentally validated DFFR and EFR control algorithms [13] in proposed balancing service scheduling methodology.

### 6. UK Balancing Service Scheduling Approach for Energy Arbitrage

BESS is capable of charging at off-peak night time hours when there is a low electricity price and then discharging at on-peak day time hours when there is a high price in order to make ‘arbitrage’ profit from the price difference. In this study, a new service scheduling approach is proposed to achieve maximum arbitrage profits whilst layering EFR and FFR services throughout the day to maximise revenue. The proposed service scheduling method is developed based on the typical daily electricity price pattern, the time of day, grid frequency profile and is based on foresight.

To examine the general pattern of daily (week/weekend) electricity price, the historical UK system pricing for the 7th Monday, 7th Thursday and 9th Sunday of each season across 2014-2015 were extracted as sample electricity price profiles (Fig. 7) [40]. It is clear from the samples of the selected days shown in Fig. 7 [40], that daily UK system prices show a



significant volatility at off-peak and on-peak hours during weekdays and weekend days. It is observed that the system price is significantly higher in April, October, January and February due to the cold weather conditions causing a high amount of energy demand on the power grid. The system price sharply decreases in summer season, especially in July, due to better weather conditions and increasingly higher generation from embedded solar sources. It is clear from Fig. 7, on the 7th Monday of each season of 2014-2015, the system price is low during night time hours between 11pm-7am and relatively high during day time hours, where the price peaks between 4pm-11pm. The price shows a similar pattern on the 7th Thursday of each season of 2014-2015, however, the peak price is shifted between 8am-12pm for the 17 July 2014. It is observed that in the non-working weekend days, the electricity price deviates from its general pattern as seen in Fig. 7. On 27 April 2014, the price is generally low during night hours and relatively high during daytime hours, where the price reaches its peak between 10am-3pm (Fig. 7). The price follows the general pattern on 27 July 2014 and on 1 Feb 2015. However, on 2 Nov 2014, due to the extreme weather the price is relatively high during night time as well as day time, but the peak price is observed between 4pm-11pm, again, following previous patterns. In conclusion, despite some exceptions the UK system electricity buy/sell price follows a common pattern that the price is lower during the night time period (11pm-7am) and higher during the daytime period, where the price typically peaks between 4pm-11pm with this shifting during summer months to 8pm-11pm.

The aim of the above information is to understand the UK electricity price trends to use in the proposed method. The daily electricity pattern is now determined using the selected historical UK electricity price profiles Fig. 7 [40]. To

supplement the potential arbitrage profits, the grid services under consideration in this study are EFR [13], DFFR, SFFR<sub>low</sub> and SFFR<sub>high</sub> services. An existing fast EFR control algorithm developed in [13] is used in this paper for EFR service delivery. The authors have shown that the EFR service can be delivered whilst generating arbitrage profits. This is achieved by manipulating the battery SOC target in the proposed frequency response control algorithms; decreasing the SOC target band when electricity prices are high, and increasing the SOC band when the prices are low, effectively shaping the BESS energy delivery profile to export at high prices and import at low prices. Using UK historical electricity pricing data [40], the proposed SOC management strategy selects the appropriate battery SOC profile to maximise the arbitrage revenue whilst delivering the EFR service. Detailed analysis of the EFR service design control algorithm and the NGET service requirements can be found in [12]-[13]. For the DFFR and SFFR services, considering the electricity price discrepancy during the day, the proposed arbitrage control algorithm selects the appropriate frequency balancing services considering the grid frequency conditions of the day and the time to maximize arbitrage. SFFR<sub>high</sub> and SFFR<sub>low</sub> services are commonly preferred at night time (off-peak) period with cost-effective electricity; however, DFFR can be utilised during on-peak as well as off-peak time periods due to the dynamic power delivery to the power grid. This paper does not cover any optimisation strategy for maximizing or calculating energy arbitrage revenue. The major aim of this study is to understand the benefits that can be gained from layering different balancing services throughout a day with different off-peak and on-peak service prices. Therefore, any existing energy arbitrage optimisation methods or any arbitrage calculation methods in literature can be implemented in the proposed balancing service scheduling approach in order to

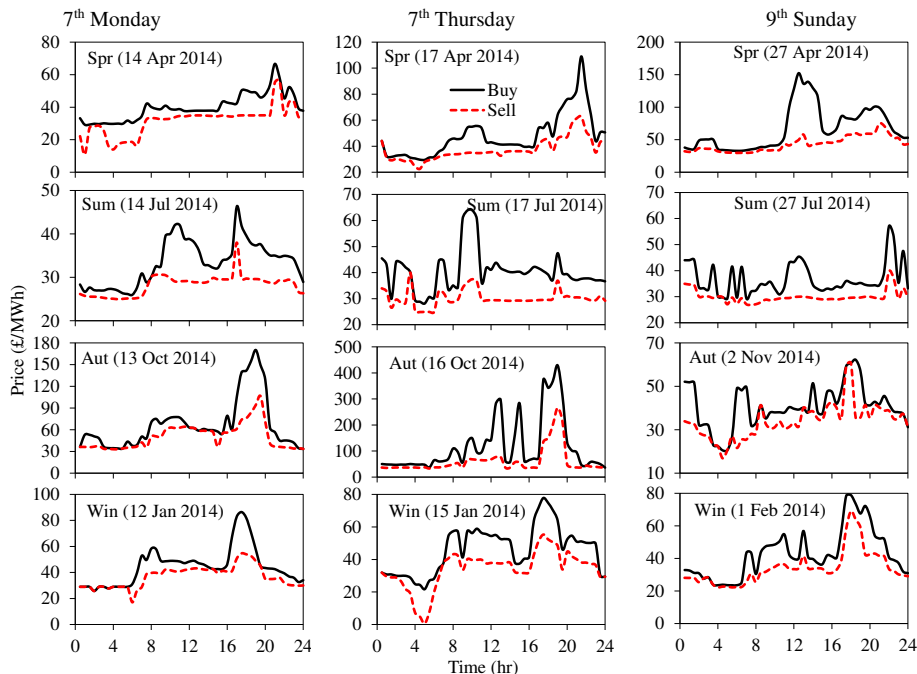

Fig. 7 Real UK Electricity system price of 7<sup>th</sup> Monday, 7<sup>th</sup> Thursday and 9<sup>th</sup> Sunday of each season of 2014-2015.

generate profits from energy arbitrage as well as frequency response service delivery. The arbitrage calculation method used in the proposed approach is described as follows.

Stored energy in the BESS is expressed in (2) [36].

$$\begin{aligned} \text{Discharging: } P_t > 0 \quad E_t &= \int_0^t \frac{P_t}{\eta_D} \cdot dt \\ \text{Charging: } P_t < 0 \quad E_t &= \int_0^t P_t \cdot \eta_C \cdot dt \end{aligned} \quad (2)$$

where  $\eta_D$  is the battery discharging efficiency,  $\eta_C$  is the battery charging efficiency,  $E_t$  is the energy stored in the BESS at hour  $t$ , if  $P_t > 0$  BESS exports power at hour  $t$ , if  $P_t < 0$  BESS imports power at hour  $t$ . The cost of the BESS charge/discharge and the total arbitrage revenue can be simply calculated using the following equation in (3), (4) [1].

$$C_C = \sum_{t=1}^{24} E_t \cdot A_{t\_sell} \quad \text{if } P_t < 0 \quad (3)$$

$$C_{DC} = \sum_{t=1}^{24} E_t \cdot A_{t\_buy} \quad \text{if } P_t > 0 \quad (4)$$

where  $C_{DC}$  is cost of BESS discharging,  $C_C$  is cost of BESS charging,  $A_{t\_sell}$  is system electricity sell price in £/MWh at hour  $t$  and  $A_{t\_buy}$  is system electricity buy price in £/MWh at hour  $t$ .

$$APR_d = C_{DC} - C_C \quad (5)$$

The charge/discharge energy output of BESS can be calculated for charging cost and discharging cost as expressed in (3) and (4), respectively. In addition, the total arbitrage revenue (APR<sub>d</sub>) can be calculated by using (3) and (4) as given in (5) [1]. As seen from the Table 6, Table 7 and Table 8, APR<sub>y</sub> is calculated on a yearly basis (£/kWh.yr) as given in (6), where SDT is the selected balancing service delivery time in hours (hr), SP is selected service price in £/hr, PD is the amount of delivered power by the selected service in kW. It should be noted that PD is 2000 kW for the EFR service [13] and 1000 kW for DFFR and SFFR services in this study.

$$APR_y = \frac{SDT \cdot SP}{PD} \cdot 365 \quad (6)$$

## 7. Simulation Results of the Service Scheduling Approach

The proposed balancing service scheduling control method is developed in MATLAB/Simulink and the simulation results are all based on the experimentally validated 1 MWh capacity of BESS delivering 2 MW EFR power [13] and 1 MW FFR power to the system. The frequency data of 7th Monday, 7th Thursday and 9th Sunday of each season of 2014-2015, containing high/medium/low frequency events, are simulated here to compare their arbitrage revenues. Based on recorded UK system sell/buy electricity price [40], the proposed grid balancing service scheduling method has been analysed for 18 different scenarios Table 5. The findings of the proposed control algorithm of the 7th Monday, 7th Thursday and 9th Sunday of each season over the 2014-2015 are shown in Table 6, Table 7 and Table 8, respectively. The arbitrage price revenue (APR<sub>d</sub>) for the day period was summed over the year to attain annual values (APR<sub>y</sub>) on a £/kWhr.yr basis as

described in Section 6. Considering the daily electricity price pattern extracted in Section 6, the forecasting service scheduling approach with 18 different scenarios for maximizing energy arbitrage is described in Table 5. The arbitrage findings and import/export energy outputs for the selected days are given in Table 6, Table 7 and Table 8.

According to scenario 2 (S2), the first service selected is the fast EFR service with a SOC band of 90-95% to charge the battery until 4am during off-peak period with relatively low electricity price. Then, SFFR-high service is selected until 6am in order to absorb a maximum constant active power (1 MW) from the grid at a specified high trigger frequency of 50.3 Hz in order to respond to this high grid frequency event on the system. The third service selected is EFR with a high SOC band of 90-95% to charge the battery until 8pm during low system costs and then its SOC band is decreased to a low band of 15-20% in order to deliver power to the grid at on-peak time where the electricity price is high. Comparing the APR findings of the scenario S1, S2, S3, S4 given in Table 6, Table 7 and Table 8, these scenarios do not seem beneficial for maximizing arbitrage profit because they mostly make arbitrage losses rather than profit in a number of considered days (14 July 2014, 17 July 2014, 2 Nov 2014 and 12 Jan 2015). In case of a high frequency event (>50.3 Hz) during the considered day (e.g. 14 April 2014), SFFR-high was successful in charging the battery which benefitted the arbitrage revenue by storing energy from the grid with cheap electricity in order to sell it at on-peak period with expensive price; this helps to increase arbitrage revenue gain. For instance, it can be seen from Fig. 8, 14 April 2014 has a high frequency event (>50.3 Hz) during the night time because of surplus power on the grid. On this day, SFFR-high was successful in charging the battery which benefitted the arbitrage revenue. The stored low cost energy is then sold to the grid during on-peak hours by delivering EFR service by lowering the target SOC of the control algorithm. It is revealed that S1, S2, S3, S4 can be favourable in the spring season in terms of grid balancing as well as arbitrage benefit. However, these scenarios, covering SFFR-high service, are rare as they are difficult to achieve without foresight.

Comparing S5 with S1, S2, S3, S4, despite using exactly the same services (SFFR-high and EFR) during the day, when delivering EFR service at on-peak time period, battery SOC will always be managed as the control algorithm does this. It is revealed that battery SOC management on delivering EFR plays an essential role in making arbitrage profit as well as grid frequency support. As seen from Table 5, scenarios S6, S7, S8, S9 have the same balancing service (only EFR) throughout the day. The APR obtained from each scenario is different because of the effect of the selected different SOC target profiles in the SOC management control during the EFR service delivery. For those scenarios, not only is SOC management essential for the arbitrage revenue, but also the electricity price profile of the considered days needs to be favourable to increase the amount of arbitrage revenue. For instance, comparing the arbitrage revenues generated from S7 in the considered days, on the 7<sup>th</sup> Thursday of autumn (16 Oct 2014), S7 provides a significant amount of arbitrage profit (£25.02) due to its high electricity price profile. However, the APR is less than £1 on the 7<sup>th</sup> Monday (14 July 2014), 7<sup>th</sup> Thursday (17 July 2014) and 9<sup>th</sup> Sunday (27 July 2014) of the

summer of 2014-2015. It can be also seen that S6, S7 and S8 do not make arbitrage losses in any day of the seasons and actually return a profit.

In scenario 10 (S10), the only selected service is DFFR with the DB of  $\pm 0.015$  Hz to deliver only dynamic active power throughout the day. With S10, which is a common choice for maximizing arbitrage profit, the battery can make arbitrage profit or service benefit from only DFFR service by importing/exporting power from the grid without having a battery SOC management control. This paper does not consider reducing the DFR tendered power to reserve power for SOC management. According to the scenario 12 (S12) shown in Table 5, the first service selected is DFFR with the DB of  $\pm 0.015$  Hz to deliver dynamic active power until 4 am with a relatively low electricity price and then SFFR-high service is selected until 7am in order to draw a maximum constant power (1 MW) from the grid at a high trigger frequency of 50.3 Hz. The third service selected is EFR with a SOC band of 90-95% to charge the battery until 4pm during low costs and then its SOC band is decreased to 15-20% in order to supply power to the grid at peak time with high electricity price. Comparing S10, S11 and S12, and S10 and S12 do not suffer any arbitrage losses in any considered days, where S11 has a  $\sim$ £5 loss in 14 April 2014 as there is a high frequency event ( $>50.3$  Hz) on that day. The battery stores energy by absorbing 1 MW power from the grid with cheap electricity at 4am-7am, but cannot adequately resell the power with expensive electricity at 7am-12pm due to the absence of battery SOC management in DFFR service. But here, S12 makes  $\sim$ £1 APR comparing the  $\sim$ £4.8 loss generated by S11. It can be seen that providing a service where the battery SOC can be managed is beneficial when there is a frequency excursion.

According to scenario 17 (S17), the first frequency response service selected is EFR with a high SOC band (90-95%) to charge the battery until 4am at off-peak time with low electricity price. Then SFFR-low service is selected until 7am to send a constant 1 MW active power to the grid at the specified low trigger frequency of 49.7 Hz in order to respond to this low grid frequency event in the power system. The third service is then selected as EFR with the high SOC band of 90-95% to charge the battery until 4pm with low-cost electricity and then its SOC band is decreased to 15-20% in order to export power to the grid selling at a high price (Fig. 9). The scenarios S13, S14, S15, S16, S17, and S18 use SFFR-low service during off-peak time periods at varying times, however, there is no low frequency event ( $<49.7$  Hz) during night time for all the considered days. Therefore, those scenarios cannot generate arbitrage profit from SFFR-low service, but as seen from the Table 9 the service availability payment is generated during the service delivery time with SFFR off-peak price of £4/hr. Comparing the APR obtained from those scenarios, S13, S14, S16 and S18 make a loss at least one time during the considered days. On the other hand, S15 and S17 do not make any arbitrage losses in any days, hence, these scenarios are suitable for making arbitrage profit, especially in high electricity price days (e.g. APR in S15=£29.66, S17=£22.94 in 16 Oct 2014). All in all, considering the general UK daily electricity pricing pattern, the proposed balancing service method can make the arbitrage revenue as shown in Table 6, Table 7 and Table 8.

**Table 5.** Service scheduling method with 18 scenarios.

Scenario (S)	Time (hr)	Service	SOC band (%)
S1	12am-2am	EFR	90-95
	2am-6am	SFFR-high	-
	6am-8pm	EFR	90-95
	8pm-12am	EFR	15-20
S2	12am-4am	EFR	90-95
	4am-6am	SFFR-high	-
	6am-8pm	EFR	90-95
	8pm-12am	EFR	15-20
S3	12am-4am	EFR	90-95
	4am-7am	SFFR-high	-
	7am-8pm	EFR	90-95
	8pm-12am	EFR	15-20
S4	12am-7am	SFFR-high	-
	7am-8pm	EFR	90-95
	8pm-12am	EFR	15-20
S5	12am-4am	EFR	90-95
	4am-7am	SFFR-high	-
	7am-4pm	EFR	45-55
	4pm-12am	EFR	15-20
S6	12am-7am	EFR	90-95
	7am-4pm	EFR	45-55
	4pm-12am	EFR	15-20
S7	12am-7am	EFR	90-95
	7am-4pm	EFR	70-75
	4pm-12am	EFR	15-20
S8	12am-4pm	EFR	90-95
	4pm-12am	EFR	15-20
S9	12am-4pm	EFR	90-95
	4pm-11pm	EFR	15-20
	11pm-12am	EFR	45-55
S10	12am-12am	DFFR	-
S11	12am-4am	DFFR	-
	4am-7am	SFFR-high	-
	7am-12pm	DFFR	-
S12	12am-4am	DFFR	-
	4am-7am	SFFR-high	-
	7am-4pm	EFR	90-95
	4pm-12am	EFR	15-20
S13	12am-7am	SFFR-low	-
	7am-8pm	EFR	90-95
	8pm-12am	EFR	15-20
S14	12am-7am	SFFR-low	-
	7am-4pm	EFR	90-95
	4pm-12am	EFR	15-20
S15	12am-7am	SFFR-low	-
	7am-12am	DFFR	-
S16	12am-4am	DFFR	-
	4am-7am	SFFR-low	-
	7am-12am	DFFR	-
S17	12am-4am	EFR	90-95
	4am-7am	SFFR-low	-
	7am-4pm	EFR	90-95
	4pm-12am	EFR	15-20
S18	12am-4am	EFR	90-95
	4am-7am	SFFR-low	-
	7am-12am	DFFR	-

It is also revealed that S10 makes the highest arbitrage profit through service delivery with no power requirement for SOC management. The APR findings from the proposed service scheduling approach are comparable with the optimized yearly arbitrage profit gained from the 6 MW/10 MWh Leighton Buzzard battery system in [37]. Comparing both APR values in year base (/kWh.yr), the potential arbitrage revenue earned from the experimental battery in [37] is higher ( $5.91$ /kWh.yr) than the APR generated from many scenarios in this proposed method for several different days, as shown in Table 6, Table 7 and Table 8; because in the reference study only arbitrage is considered, no other balancing services are delivered simultaneously.

**Table 8** Arbitrage price revenue (APR) findings and energy output of 7<sup>th</sup> Monday of each season of 2014/2015.

7 <sup>TH</sup> MONDAY OF EACH SEASON OF 2014/2015												
Scen. (S)	SPRING (14 April 2014)			SUMMER (14 July 2014)			AUTUMN (13 Oct 2014)			WINTER (12 Jan 2015)		
	Energy Output (kWh/day)		APR (£/kWh)	Energy Output (kWh/day)		APR (£/kWh)	Energy Output (kWh/day)		APR (£/kWh)	Energy Output (kWh/day)		APR (£/kWh)
	Imp.	Exp.		Imp.	Exp.		Imp.	Exp.		Imp.	Exp.	
S1	1528	1287	2.315	1397	1071	-0.414	1529	1299	0.008	1348	845.1	-2.841
S2	1614	1359	2.455	1434	1102	-0.267	1650	1400	1.594	1382	873.1	-2.555
S3	1524	1284	2.439	1397	1070	-0.364	1597	1355	1.129	1352	848.2	-2.754
S4	1355	1142	1.7	1297	986.8	-0.73	1385	1178	-1.462	1199	720.1	-3.429
S5	1513	1269	0.779	1129	976.1	0.733	1520	1303	5.024	1006	900.7	1.97
S6	1363	1143	1.606	1482	1272	0.913	1762	1504	6.165	1093	973.6	2.044
S7	1392	1170	2.146	1525	1307	0.986	1772	1513	7.716	1147	1025	1.723
S8	1512	1267	2.82	1522	1305	1.149	1757	1500	6.888	1317	1077	0.604
S9	1546	1267	2.608	1566	1260	0.676	1788	1497	6.682	1350	915.8	-0.558
S10	901.8	958.2	4.292	830.9	775.7	0.912	1010	1197	15	1016	1476	13.64
S11	1636	873.5	-4.791	735.9	662.1	0.666	957.5	978	12.46	988.4	1466	13.62
S12	1619	1270	0.872	1458	1230	0.266	1320	1507	9.158	1312	971.6	1.402
S13	1237	1044	1.954	1297	986.8	0.73	1385	1178	-1.462	1199	720.1	-3.429
S14	1232	1033	1.562	1255	1082	0.501	1384	1189	3.721	1077	875.1	-0.16
S15	698.1	714.7	2.298	607.2	508.3	0.27	790.5	736.1	11.13	772.5	1344	14.61
S16	830.9	873.5	3.295	735.9	662.1	0.666	957.5	978	-12.46	988.4	1466	13.62
S17	1338	1122	2.335	1355	1165	0.867	1606	1374	5.969	1229	1003	0.5308
S18	1305	737.4	2.917	1224	518.1	-3.754	1538	746.7	4.839	1158	1384	12.84

**Table 6.** Arbitrage price revenue (APR) findings and energy output of 7<sup>th</sup> Thursday of each season of 2014/2015.

7 <sup>TH</sup> THURSDAY OF EACH SEASON OF 2014/2015												
Scen. (S)	SPRING (17 April 2014)			SUMMER (17 July 2014)			AUTUMN (16 Oct 2014)			WINTER (15 Jan 2015)		
	Energy Output (kWh/day)		APR (£/kWh)	Energy Output (kWh/day)		APR (£/kWh)	Energy Output (kWh/day)		APR (£/kWh)	Energy Output (kWh/day)		APR (£/kWh)
	Imp.	Exp.		Imp.	Exp.		Imp.	Exp.		Imp.	Exp.	
S1	1343	1156	5.052	1520	907.1	-2.277	1630	1315	11.6	1546	1124	-0.447
S2	1464	1257	5.344	1581	958.1	-1.823	1703	1377	12.93	1661	1220	0.583
S3	1378	1186	5.259	1552	933.2	-2.027	1663	1335	12.78	1593	1163	0.402
S4	1183	1022	4.574	1408	813.2	-2.334	1441	1158	7.604	1409	1009	-1.118
S5	1206	1042	2.488	1183	956.1	0.454	1464	1246	23.13	1453	1203	3.567
S6	1501	1289	3.056	1472	1198	0.737	1731	1470	24.29	1700	1410	4.775
S7	1495	1284	4.808	1520	1238	0.929	1782	1512	25.02	1718	1424	5.161
S8	1554	1333	5.751	1563	1274	1.134	1790	1518	24.3	1724	1430	5.024
S9	1624	1282	4.73	1647	1248	0.493	1967	1464	22.69	1874	1409	4.113
S10	1066	1057	2.586	746.5	918.5	5.0	1016	1082	31.99	962.7	1017	3.865
S11	968.2	939.4	2.081	690.8	851.8	4.569	880.8	921.1	30.71	873	913.2	3.0
S12	1003	1462	11.16	1482	1200	0.2	1559	1266	17.42	1400	1412	4.777
S13	1183	1022	4.574	1408	813.2	-2.334	1441	1158	7.604	1409	1009	-1.118
S14	993.3	863.8	2.905	1333	1081	0.31	1399	1191	17.76	1352	1119	2.188
S15	650.5	559.6	1.316	562.6	716.2	4.37	786.7	808.7	29.66	666.9	663.8	2.562
S16	968.2	939.4	2.081	690.8	851.8	4.569	880.8	921.1	30.71	873	913.2	2.998
S17	1357	1168	5.405	1476	1201	0.615	1601	1360	22.94	1537	1273	3.707
S18	1503	600.4	-6.028	988.7	738.4	2.309	1406	840.7	25.63	1390	668.5	-1.716

**Table 7.** Arbitrage price revenue (APR) findings and energy output of 9<sup>th</sup> Sunday of each season of 2014/2015.

9 <sup>TH</sup> SUNDAY OF EACH SEASON OF 2014/2015												
Scen. (S)	SPRING (27 April 2014)			SUMMER (27 July 2014)			AUTUMN (2 Nov 2014)			WINTER (1 Feb 2015)		
	Energy Output (kWh/day)		APR (£/kWh)	Energy Output (kWh/day)		APR (£/kWh)	Energy Output (kWh/day)		APR (£/kWh)	Energy Output (kWh/day)		APR (£/kWh)
	Imp.	Exp.		Imp.	Exp.		Imp.	Exp.		Imp.	Exp.	
S1	1397	1156	4.56	1385	1147	0.3204	1382	1039	-0.47	1417	1195	0.801
S2	1456	1205	5.347	1440	1194	0.192	1480	1121	-0.004	1554	1310	1.1
S3	1414	1170	4.621	1417	1174	0.207	1439	1086	-0.19	1523	1284	1.126
S4	1269	1048	3.62	1209	1000	0.49	1238	918.3	-1.034	1259	1063	0.6
S5	1160	988.5	3.586	1252	1087	0.043	1283	1076	1.115	1340	1141	1.864
S6	1411	1199	3.636	1422	1229	0.007	1506	1262	1.635	1544	1312	2.294
S7	1461	1241	5.599	1433	1238	0.042	1520	1274	1.958	1579	1342	3.038
S8	1565	1328	7.126	1462	1263	0.062	1510	1266	2.38	1641	1393	3.293
S9	1667	1299	6.045	1492	1250	-0.18	1623	1246	1.592	1724	1371	2.723
S10	545.6	494.3	5.572	773.7	705.6	1.148	814.1	907.4	4.401	866.9	824.1	3.273
S11	521	464.9	5.491	670	581.6	0.752	766	850	3.597	815.6	762.7	2.889
S12	1620	1120	1.456	1201	1169	1.906	1140	1291	5.181	1561	1197	1.247
S13	1269	1048	3.62	1209	1000	0.49	1238	918.3	-1.034	1259	1063	0.597
S14	1297	1104	4.8	1166	1016	0.394	1170	981.8	1.054	1258	1073	2.374
S15	455.1	386.1	5.189	568.2	459.9	0.08	563.3	607.6	2.513	695.5	619.1	2.247
S16	521	464.9	5.491	670	581.6	0.752	766	850	3.597	815.6	762.7	2.889
S17	1442	1225	5.794	1374	1189	0.111	1392	1167	1.879	1522	1294	2.904
S18	1144	457	1.803	1465	461.3	-6.327	1439	613	-4.3	1461	745.5	-2.043

10

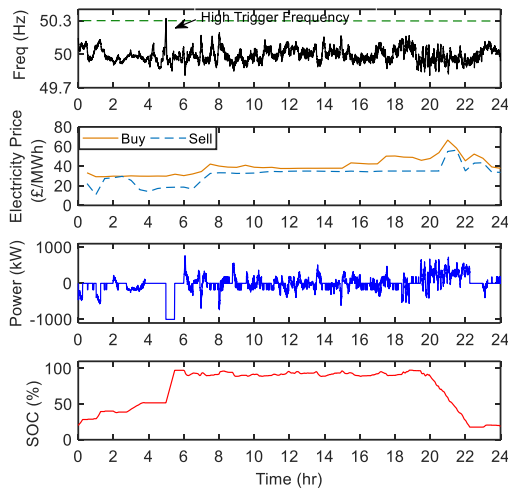

**Fig. 8** Simulation results of the arbitrage control algorithm for 14<sup>th</sup> April 2014 for scenario 2 (S2).

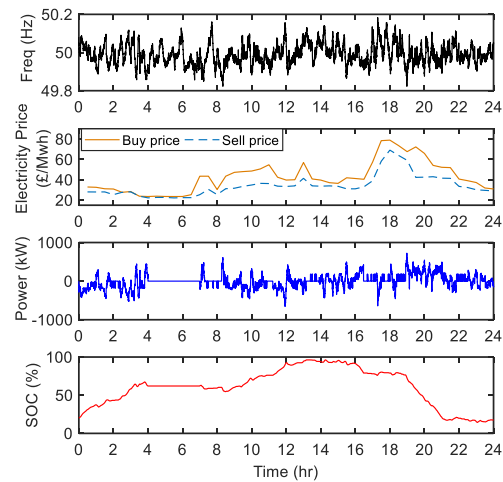

**Fig. 9** Simulation results of the arbitrage control algorithm for 1<sup>st</sup> Feb 2015 for scenario 17 (S17).

**Table 9** Total service availability payment (SAP) obtained from each scenario of the service scheduling approach in Table 5.

Scenario (S)	DFFR			SFFR			EFR			SAP (£/day)	SAP (£/kW h.yr)
	SDT (hr/day)	SP (£/hr)	SAP (£/kWh.yr)	SDT (hr/day)	SP (£/hr)	SAP (£/kWh.yr)	SDT (hr/day)	SP (£/hr)	SAP (£/kWh.yr)		
S1	-	-	-	4	£4	£5.84	20	£10	£36.50	£216	<b>£42.34</b>
S2	-	-	-	2	£4	£2.92	22	£10	£40.15	£228	<b>£43.42</b>
S3	-	-	-	3	£4	£4.38	21	£10	£38.32	£222	<b>£42.7</b>
S4	-	-	-	7	£4	£10.22	17	£10	£31.02	£198	<b>£41.24</b>
S5	-	-	-	3	£4	£4.38	21	£10	£38.32	£222	<b>£42.7</b>
S6	-	-	-	-	-	-	24	£10	£43.8	£240	<b>£43.8</b>
S7	-	-	-	-	-	-	24	£10	£43.8	£240	<b>£43.8</b>
S8	-	-	-	-	-	-	24	£10	£43.8	£240	<b>£43.8</b>
S9	-	-	-	-	-	-	24	£10	£43.8	£240	<b>£43.8</b>
S10	24	£11	£96.36	-	-	-	-	-	-	£264	<b>£96.36</b>
S11	21	£11	£84.31	3	£4	£4.38	-	-	-	£243	<b>£88.69</b>
S12	4	£11	£16.06	3	£4	£4.38	17	£10	£31.02	£226	<b>£51.46</b>
S13	-	-	-	7	£4	£10.22	17	£10	£31.02	£198	<b>£41.24</b>
S14	-	-	-	7	£4	£10.22	17	£10	£31.02	£198	<b>£41.24</b>
S15	17	£11	£68.25	7	£4	£10.22	-	-	-	£215	<b>£78.47</b>
S16	21	£11	£84.31	3	£4	£4.38	-	-	-	£243	<b>£88.69</b>
S17	-	-	-	3	£4	£4.38	21	£10	£38.32	£222	<b>£42.7</b>
S18	17	£11	£68.25	3	£4	£4.38	4	£10	£7.3	£239	<b>£79.93</b>

Using frequency response service payments (for EFR=£10/hr, DFFR=£11/hr and SFFR off peak=£4 and on-peak=£6/hr) [32], the daily and yearly frequency response service availability payment (SAP) generated from each scenario in Table 5 are shown in Table 9. It can be seen that scenario 10 (S10), which delivers only DFFR throughout the day, makes the highest SAP (£96.36/kWh.yr) due to the highest availability price of DFFR service (£11/day.hr) in the balancing service. It should be noted that in the previous study [1], in the calculation of yearly based APR, the delivered service power (PD) was set to 2 MW for all the services, considering the 2 MW EFR power as a reference PD for all the balancing services. But the method used in [1] is improved in this paper as the APR is independently calculated for each delivered service by using their own PD (PD in EFR = 2 MW and FFR = 1 MW). Considering this, S1 is selected as the best scenario in the previous study [1], with

£2.315/kWh.yr arbitrage revenue. This paper almost doubles the revenue (£4.292/kWh.yr) with scenario 10 (S10), by delivering only DFFR service throughout the day and also around 20% higher revenue with S8, delivering only EFR service that has effective SOC management.

## 8. Conclusion

A dynamic (DFFR), a static high (SFFR-high) and low (SFFR-low) firm frequency response control algorithm based on a model of a 1 MW/1 MWh BESS has been developed to meet the NGET published service requirements. When there is a grid frequency deviation on the grid, the BESS supplies a dynamic power according to a specified DFFR envelope. SFFR delivers a non-dynamic service where an agreed amount of power is delivered if the grid frequency reaches a certain trigger point of 49.7 Hz (SFFR-low) or 50.3 Hz

(SFFR-high). In addition, a new balancing service scheduling method for maximizing energy arbitrage has been presented that uses layering of grid balancing services (DFFR, SFFR-high, SFFR-low and EFR) throughout the day. The advantage of this scheduling method is that it generates arbitrage profit and combines balancing service availability payment revenue through service layering and novel SOC management techniques. An existing EFR control algorithm has been used in the proposed approach, where the battery SOC target band is periodically moved according to the electricity pricing profile for the day in order to generate arbitrage revenue. Setting the SOC band low has the effect of exporting energy and setting the SOC band high imports energy. Simulation results of the proposed service scheduling approach were obtained using NGET frequency data for 7<sup>th</sup> Monday, 7<sup>th</sup> Thursday, 9<sup>th</sup> Sunday of each season of 2014/2015, which contains a mix of frequency profile days. The simulations are based on experimentally validated model of the Willenhall Energy Storage System (WESS) – a 2 MW/1 MWh LTO BESS – demonstrating that arbitrage profits can be made by layering different balancing services throughout the day with foresight. The revenue generated by a BESS can be maximized using a suitable scheduling scenario that will vary depending on the day/month/season of the year.

## 9. Acknowledgments

This work was supported by the UK Engineering and Physical Sciences Research Council (EPSRC) Multi-scale Analysis for Facilities for Energy Storage (Manifest) project [EP/N032888/1].

## 10. References

- [1] Gundogdu, B., Gladwin, D. T., Stone, D. A.: 'Battery energy management strategies for UK firm frequency response service and energy arbitrage', *IET Int. Conf. Power Electron. Mach. Drives (PEMD)*, 2018
- [2] Bhattacharjee, C., Roy, B. K.: 'Advanced fuzzy power extraction control of wind energy conversion system for power quality improvement in a grid tied hybrid generation system', *IET Gen. Transm. Distrib.*, 2016, **10**, (5), pp. 1179-1189
- [3] Bevrani, H., Ghosh, A., Ledwich, G.: 'Renewable energy sources and frequency regulation: survey and new perspectives', in *IET Renew. Power Gener.*, 2010, **4**, (5), pp. 438-457
- [4] Makarov, Y. V., Reshetov, V. I., Stroeve, A. *et al.*: 'Blackout prevention in the united states, europe, and russia', *Proc. IEEE*, 2005, (93), **11**, pp. 1942-1955
- [5] Zhu, Q., Zhang, C. K., Yao, W., *et al.*: 'Frequency regulation of smart grid via dynamic demand control and battery energy storage system' (Energy Engineering, 2016), 'Smarter Energy: From Smart Metering to the Smart Grid', Ch. 8, pp. 209-243
- [6] Chen, H., Cong, T. N., Yang, W., *et al.*: 'Progress in electrical energy storage system: A critical review', *Prog. Natural Sci.*, 2009, **19**, (3), pp. 291-312
- [7] Hill, C. A., Such, M. C., Chen, D., *et al.*: 'Battery energy storage for enabling integration of distributed solar power generation', *IEEE Trans. Smart Grid*, 2012, **3**, (2), pp. 850-857
- [8] Oudalov, A., Chartouni, D., Ohler, C.: 'Optimizing a battery energy storage system for primary frequency control', *IEEE Trans. Power Syst.*, 2007, **22**, (3), pp. 1259-1266
- [9] Mercier, P., Cherkaoui, R., Oudalov, A.: 'Optimizing a battery energy storage system for frequency control application in an isolated power system', *IEEE Trans. Power Syst.*, 2009, **24**, (3), pp. 1469-1477
- [10] Lalor, G., Mullane, A., O'Malley, M.: 'Frequency control and wind turbine technologies', *IEEE Trans. Power Syst.*, 2005, **20**, (4), pp. 1905-1913
- [11] Jie, B., Tsuji, T., Uchida, K.: 'Analysis and modelling regarding frequency regulation of power systems and power supply-demand-control based on penetration of renewable energy sources', *J. Eng.*, 2017, **2017**, (13), pp. 1824-1828
- [12] Gundogdu, B., Nejad, S., Gladwin, D. T., Stone, D. A.: 'A battery energy management strategy for UK enhanced frequency response', *IEEE Int. Symp. Ind. Electron. (ISIE)*, 2017, pp. 26-31
- [13] Gundogdu, B., Nejad, S., Gladwin, D. T., *et al.*: 'A battery energy management strategy for UK enhanced frequency response and triad avoidance', *IEEE Trans. Ind. Electron.*, 2018, vol. 65, no.12, pp. 9509-9517, Dec. 2018.
- [14] Anvari-Moghaddam, A., Guerrero, J. M., Vasquez, J. C., *et al.*: 'Efficient energy management for a grid-tied residential microgrid', *IET Gen. Transm. Distrib.*, 2017, **11**, (11), pp. 2752-2761
- [15] NGET: 'Enhanced Frequency Control Capability (EFCC), Battery Storage Investigation Report', 2015
- [16] Feehally, T. *et al.*, 'Battery energy storage systems for the electricity grid: UK research facilities,' *IET Int. Conf. Power Electron. Mach. Drives (PEMD)*, 2016, pp. 1-6
- [17] Sioshansi, R., Denholm, P., Jenkin, T., *et al.*: 'Estimating the value of electricity storage in PJM: Arbitrage and some welfare effects', *Energy Economics*, 2009, **31**, (2), pp. 269-277
- [18] Teng, F., Aunedi, M., Moreira, R., *et al.*: 'Business case for distributed energy storage', *CIREN-Open Access Proc. J.*, 2017, **2017**, (1), pp. 1605-1608
- [19] Durma, E., Parlak, D., Loğoğlu, E. U., *et al.*: 'Adaptation of renewable based power plants to the energy market using battery energy storage systems', *Int. Conf. Renew. Energy Res. Appl.*, (ICRERA), 2014, pp. 643-647
- [20] Xing, H., Lin, Z., Fu, M., *et al.*: 'Distributed algorithm for dynamic economic power dispatch with energy storage in smart grids', *IET Control Theory Appl.*, 2017, **11**, (11), pp. 1813-1821
- [21] Gundogdu, B., Gladwin, D. T., Foster, M. P., Stone, D. A.: 'A forecasting battery state of charge management strategy for frequency response in the UK system', *IEEE Int. Conf. Ind. Techno. (ICIT)*, 2018, pp. 1726-1731
- [22] Mbungu, N. T., Naidoo, R. M., Bansal, R.C.: 'Real-time Electricity Pricing: TOU-MPC Based Energy Management for Commercial Buildings', *Energy Procedia*, 2017, **105**, pp. 3419-3424
- [23] Mbungu, N. T., Naidoo, R. M., Bansal, R.C., *et al.*: 'Smart SISO-MPC based energy management system for commercial buildings: Technology trends', *Future Techno. Conf. (FTC)*, 2016, pp. 750-753
- [24] Basaran, K., Cetin, N. S., Borekci, S.: 'Energy management for on-grid and off-grid wind/PV and battery hybrid systems', *IET Renew. Power Gener.*, 2017, **11**, (5), pp. 642-649
- [25] Eghtedarpour, N., Farjah, E.: 'Distributed charge/discharge control of energy storages in a renewable-energy-based DC micro-grid', *IET Renew. Power Gener.*, 2014, **8**, (1), pp. 45-57
- [26] Ampatzis, M., Nguyen, P. H., Kamphuis, I. G., *et al.*: 'Robust optimisation for deciding on real-time flexibility of storage-integrated photovoltaic units controlled by intelligent software agents', *IET Renew. Power Gener.*, 2017, **11**, (12), pp. 1527-1533
- [27] Barbour, E., Wilson, I. A. G., Bryden, I. G., *et al.*: 'Towards an objective method to compare energy storage technologies: development and validation of a model to determine the upper boundary of revenue available from electrical price arbitrage', *Energy & Environmental Sci.*, 2012, **5**, (1), pp. 5425-5436
- [28] Gill, S., Barbour, E., Wilson, I. A. G., *et al.*: 'Maximising revenue for non-firm distributed wind generation with energy storage in an active management scheme', *IET Renew. Power Gener.*, 2013, **7**, (5), pp. 421-430
- [29] Khani, H., Zadeh, M. R. D.: 'Online adaptive real-time optimal dispatch of privately owned energy storage systems using public-domain electricity market prices', *IEEE Trans. Power Syst.*, 2015, **30**, (2), pp. 930-938
- [30] Dunbar, A., Cradden, L. C., Wallace, R., *et al.*: 'Impact of wind power on arbitrage revenue for electricity storage', *IET Gener. Transm. Distrib.*, 2016, **10**, (3), pp. 798-806
- [31] Dunbar, A., Wallace, A. R., Harrison, G. P.: 'Energy storage and wind power: sensitivity of revenue to future market uncertainties', *IET Renew. Power Gener.*, 2016, **10**, (10), pp. 1535-1542
- [32] National Grid, 'Technical guidance and testing procedure for static and dynamic demand response and battery storage providers of frequency balancing services', <http://www2.nationalgrid.com/uk/services/balancing-services/service-guides/>, accessed 20 July 2018
- [33] National Grid, 'Firm frequency response a guide to the services procured by national grid to manage system frequency', <https://www.nationalgrid.com/sites/default/files/documents/Firm%20Frequency%20Response%201.1.pdf>, accessed 20 July 2018

- [34] National Grid, 'Firm frequency response interactive guidance', <https://www.nationalgrid.com/uk/electricity/balancing-services/frequency-response-services>, accessed 18 January 2017
- [35] National Grid, 'Enhanced frequency response interactive guidance', <https://www.nationalgrid.com/uk/electricity/balancing-services/frequency-response-services/enhanced-frequency-response-efr>, accessed 18 January 2017
- [36] Gundogdu, B., Gladwin, D. T., Stone, D. A.: 'Battery SOC management strategy for enhanced frequency response and day-ahead energy scheduling of BESS for energy arbitrage', IEEE Ind. Electron. Soc. Annu. Conf. (IECON), 2017, pp. 7635-7640
- [37] Newbery, D. G.: 'A simple introduction to the economics of storage: shifting demand and supply over time and space', Cambridge Working Paper in Economics, University of Cambridge EPRG, 2016, **1661**, pp.1-24
- [38] National Grid, 'Battery Storage Investigation Report - June 2015', <http://www2.nationalgrid.com/WorkArea/DownloadAsset.aspx?id=8589939031>, accessed 18 February 2016
- [39] UoS, 'Willenhall: 2MW Battery Energy Storage Demonstrator', <http://www.sheffield.ac.uk/creesa/willenhall/facts>, accessed 20 July 2018
- [40] Elexon, 'System sell and buy prices', <https://www.bmreports.com/bmrs/?q=balancing/systemsellbuyprices>, accessed 20 July 2018
- [41] National Grid, 'Firm frequency response', <https://www.nationalgrideso.com/balancing-services/frequency-response-services/firm-frequency-response-ffr>