

## Alternative tumour necrosis factor inhibitors (TNFi) or abatacept or rituximab following failure of initial TNFi in rheumatoid arthritis: the SWITCH RCT

*Sarah Brown, Colin C Everett, Kamran Naraghi, Claire Davies, Bryony Dawkins, Claire Hulme, Christopher McCabe, Sue Pavitt, Paul Emery, Linda Sharples and Maya H Buch*



**National Institute for  
Health Research**



# Alternative tumour necrosis factor inhibitors (TNFi) or abatacept or rituximab following failure of initial TNFi in rheumatoid arthritis: the SWITCH RCT

Sarah Brown,<sup>1</sup> Colin C Everett,<sup>1</sup> Kamran Naraghi,<sup>2</sup> Claire Davies,<sup>1</sup> Bryony Dawkins,<sup>3</sup> Claire Hulme,<sup>3</sup> Christopher McCabe,<sup>4</sup> Sue Pavitt,<sup>5</sup> Paul Emery,<sup>3,6</sup> Linda Sharples<sup>1</sup> and Maya H Buch<sup>3,6\*</sup>

<sup>1</sup>Clinical Trials Research Unit, Leeds Institute of Clinical Trials Research, University of Leeds, Leeds, UK

<sup>2</sup>Leeds Institute of Rheumatic and Musculoskeletal Medicine, University of Leeds, Leeds, UK

<sup>3</sup>Academic Unit of Health Economics, Leeds Institute of Health Sciences, University of Leeds, Leeds, UK

<sup>4</sup>Department of Emergency Medicine, University of Alberta, Edmonton, AB, Canada

<sup>5</sup>Dental Translational and Clinical Research Unit, University of Leeds, Leeds, UK

<sup>6</sup>National Institute for Health Research Leeds Musculoskeletal Biomedical Research Unit, Leeds Teaching Hospitals NHS Trust, Leeds, UK

\*Corresponding author

**Declared competing interests of authors:** Maya H Buch reports grants from Pfizer and Chugai Pharmaceutical Co. Ltd (Roche), and personal fees from AstraZeneca, Mitsubishi Tanabe Pharma Corporation, Bristol-Myers Squibb, Chugai Pharmaceutical Co. Ltd (Roche), Sandoz and R-Pharm, during the conduct of the study. Claire Hulme reports grants from the National Institute for Health Research (NIHR) Health Technology Assessment (HTA) programme, during the conduct of the study, and was a member of the NIHR HTA Commissioning Board during the conduct of the study. Paul Emery reports grants and personal fees from Pfizer, Merck Sharp & Dohme Corp., AbbVie, Bristol-Myers Squibb, UCB Pharma Ltd, Roche, Novartis, Samsung, Sandoz, and Eli Lilly and Company, during the conduct of the study. Sue Pavitt is a member of the Efficacy and Mechanism Evaluation Board and NIHR Clinical Trials Unit Board and has been a recipient of NIHR Clinical Trials Unit Support funding. Linda Sharples, Sarah Brown and Claire Davies report grants from NIHR HTA programme during the conduct of the study. Christopher McCabe reports that historically he worked as a paid consultant for a number of pharmaceutical companies. He has also done paid extensive work for the NHS.

Published June 2018

DOI: 10.3310/hta22340



This report should be referenced as follows:

Brown S, Everett CC, Naraghi K, Davies C, Dawkins B, Hulme C, *et al.* Alternative tumour necrosis factor inhibitors (TNFi) or abatacept or rituximab following failure of initial TNFi in rheumatoid arthritis: the SWITCH RCT. *Health Technol Assess* 2018;**22**(34).

*Health Technology Assessment* is indexed and abstracted in *Index Medicus/MEDLINE*, *Excerpta Medica/EMBASE*, *Science Citation Index Expanded (SciSearch®)* and *Current Contents®/Clinical Medicine*.



ISSN 1366-5278 (Print)

ISSN 2046-4924 (Online)

Impact factor: 4.236

*Health Technology Assessment* is indexed in MEDLINE, CINAHL, EMBASE, The Cochrane Library and the Clarivate Analytics Science Citation Index.

This journal is a member of and subscribes to the principles of the Committee on Publication Ethics (COPE) ([www.publicationethics.org/](http://www.publicationethics.org/)).

Editorial contact: [journals.library@nhr.ac.uk](mailto:journals.library@nhr.ac.uk)

The full HTA archive is freely available to view online at [www.journalslibrary.nhr.ac.uk/hta](http://www.journalslibrary.nhr.ac.uk/hta). Print-on-demand copies can be purchased from the report pages of the NIHR Journals Library website: [www.journalslibrary.nhr.ac.uk](http://www.journalslibrary.nhr.ac.uk)

## Criteria for inclusion in the *Health Technology Assessment* journal

Reports are published in *Health Technology Assessment* (HTA) if (1) they have resulted from work for the HTA programme, and (2) they are of a sufficiently high scientific quality as assessed by the reviewers and editors.

Reviews in *Health Technology Assessment* are termed 'systematic' when the account of the search appraisal and synthesis methods (to minimise biases and random errors) would, in theory, permit the replication of the review by others.

## HTA programme

The HTA programme, part of the National Institute for Health Research (NIHR), was set up in 1993. It produces high-quality research information on the effectiveness, costs and broader impact of health technologies for those who use, manage and provide care in the NHS. 'Health technologies' are broadly defined as all interventions used to promote health, prevent and treat disease, and improve rehabilitation and long-term care.

The journal is indexed in NHS Evidence via its abstracts included in MEDLINE and its Technology Assessment Reports inform National Institute for Health and Care Excellence (NICE) guidance. HTA research is also an important source of evidence for National Screening Committee (NSC) policy decisions.

For more information about the HTA programme please visit the website: <http://www.nets.nhr.ac.uk/programmes/hta>

## This report

The research reported in this issue of the journal was funded by the HTA programme as project number 08/116/75. The contractual start date was in April 2011. The draft report began editorial review in September 2016 and was accepted for publication in February 2017. The authors have been wholly responsible for all data collection, analysis and interpretation, and for writing up their work. The HTA editors and publisher have tried to ensure the accuracy of the authors' report and would like to thank the reviewers for their constructive comments on the draft document. However, they do not accept liability for damages or losses arising from material published in this report.

This report presents independent research funded by the National Institute for Health Research (NIHR). The views and opinions expressed by authors in this publication are those of the authors and do not necessarily reflect those of the NHS, the NIHR, NETSCC, the HTA programme or the Department of Health and Social Care. If there are verbatim quotations included in this publication the views and opinions expressed by the interviewees are those of the interviewees and do not necessarily reflect those of the authors, those of the NHS, the NIHR, NETSCC, the HTA programme or the Department of Health and Social Care.

**© Queen's Printer and Controller of HMSO 2018. This work was produced by Brown *et al.* under the terms of a commissioning contract issued by the Secretary of State for Health and Social Care. This issue may be freely reproduced for the purposes of private research and study and extracts (or indeed, the full report) may be included in professional journals provided that suitable acknowledgement is made and the reproduction is not associated with any form of advertising. Applications for commercial reproduction should be addressed to: NIHR Journals Library, National Institute for Health Research, Evaluation, Trials and Studies Coordinating Centre, Alpha House, University of Southampton Science Park, Southampton SO16 7NS, UK.**

Published by the NIHR Journals Library ([www.journalslibrary.nhr.ac.uk](http://www.journalslibrary.nhr.ac.uk)), produced by Prepress Projects Ltd, Perth, Scotland ([www.prepress-projects.co.uk](http://www.prepress-projects.co.uk)).

## NIHR Journals Library Editor-in-Chief

**Professor Tom Walley** Director, NIHR Evaluation, Trials and Studies and Director of the EME Programme, UK

## NIHR Journals Library Editors

**Professor Ken Stein** Chair of HTA and EME Editorial Board and Professor of Public Health, University of Exeter Medical School, UK

**Professor Andrée Le May** Chair of NIHR Journals Library Editorial Group (HS&DR, PGfAR, PHR journals)

**Dr Martin Ashton-Key** Consultant in Public Health Medicine/Consultant Advisor, NETSCC, UK

**Professor Matthias Beck** Professor of Management, Cork University Business School, Department of Management and Marketing, University College Cork, Ireland

**Dr Tessa Crilly** Director, Crystal Blue Consulting Ltd, UK

**Dr Eugenia Cronin** Senior Scientific Advisor, Wessex Institute, UK

**Dr Peter Davidson** Director of the NIHR Dissemination Centre, University of Southampton, UK

**Ms Tara Lamont** Scientific Advisor, NETSCC, UK

**Dr Catriona McDaid** Senior Research Fellow, York Trials Unit, Department of Health Sciences, University of York, UK

**Professor William McGuire** Professor of Child Health, Hull York Medical School, University of York, UK

**Professor Geoffrey Meads** Professor of Wellbeing Research, University of Winchester, UK

**Professor John Norrie** Chair in Medical Statistics, University of Edinburgh, UK

**Professor John Powell** Consultant Clinical Adviser, National Institute for Health and Care Excellence (NICE), UK

**Professor James Raftery** Professor of Health Technology Assessment, Wessex Institute, Faculty of Medicine, University of Southampton, UK

**Dr Rob Riemsma** Reviews Manager, Kleijnen Systematic Reviews Ltd, UK

**Professor Helen Roberts** Professor of Child Health Research, UCL Great Ormond Street Institute of Child Health, UK

**Professor Jonathan Ross** Professor of Sexual Health and HIV, University Hospital Birmingham, UK

**Professor Helen Snooks** Professor of Health Services Research, Institute of Life Science, College of Medicine, Swansea University, UK

**Professor Jim Thornton** Professor of Obstetrics and Gynaecology, Faculty of Medicine and Health Sciences, University of Nottingham, UK

**Professor Martin Underwood** Director, Warwick Clinical Trials Unit, Warwick Medical School, University of Warwick, UK

Please visit the website for a list of editors: [www.journalslibrary.nihr.ac.uk/about/editors](http://www.journalslibrary.nihr.ac.uk/about/editors)

**Editorial contact:** [journals.library@nihr.ac.uk](mailto:journals.library@nihr.ac.uk)



# Abstract

## Alternative tumour necrosis factor inhibitors (TNFi) or abatacept or rituximab following failure of initial TNFi in rheumatoid arthritis: the SWITCH RCT

Sarah Brown,<sup>1</sup> Colin C Everett,<sup>1</sup> Kamran Naraghi,<sup>2</sup> Claire Davies,<sup>1</sup> Bryony Dawkins,<sup>3</sup> Claire Hulme,<sup>3</sup> Christopher McCabe,<sup>4</sup> Sue Pavitt,<sup>5</sup> Paul Emery,<sup>3,6</sup> Linda Sharples<sup>1</sup> and Maya H Buch<sup>3,6\*</sup>

<sup>1</sup>Clinical Trials Research Unit, Leeds Institute of Clinical Trials Research, University of Leeds, Leeds, UK

<sup>2</sup>Leeds Institute of Rheumatic and Musculoskeletal Medicine, University of Leeds, Leeds, UK

<sup>3</sup>Academic Unit of Health Economics, Leeds Institute of Health Sciences, University of Leeds, Leeds, UK

<sup>4</sup>Department of Emergency Medicine, University of Alberta, Edmonton, AB, Canada

<sup>5</sup>Dental Translational and Clinical Research Unit, University of Leeds, Leeds, UK

<sup>6</sup>National Institute for Health Research Leeds Musculoskeletal Biomedical Research Unit, Leeds Teaching Hospitals NHS Trust, Leeds, UK

\*Corresponding author [m.buch@leeds.ac.uk](mailto:m.buch@leeds.ac.uk)

**Background:** Rheumatoid arthritis (RA), the most common autoimmune disease in the UK, is a chronic systemic inflammatory arthritis that affects 0.8% of the UK population.

**Objectives:** To determine whether or not an alternative class of biologic disease-modifying antirheumatic drugs (bDMARDs) are comparable to rituximab in terms of efficacy and safety outcomes in patients with RA in whom initial tumour necrosis factor inhibitor (TNFi) bDMARD and methotrexate (MTX) therapy failed because of inefficacy.

**Design:** Multicentre, Phase III, open-label, parallel-group, three-arm, non-inferiority randomised controlled trial comparing the clinical and cost-effectiveness of alternative TNFi and abatacept with that of rituximab (and background MTX therapy). Eligible consenting patients were randomised in a 1 : 1 : 1 ratio using minimisation incorporating a random element. Minimisation factors were centre, disease duration, non-response category and seropositive/seronegative status.

**Setting:** UK outpatient rheumatology departments.

**Participants:** Patients aged  $\geq 18$  years who were diagnosed with RA and were receiving MTX, but had not responded to two or more conventional synthetic disease-modifying antirheumatic drug therapies and had shown an inadequate treatment response to a first TNFi.

**Interventions:** Alternative TNFi, abatacept or rituximab (and continued background MTX).

**Main outcome measures:** The primary outcome was absolute reduction in the Disease Activity Score of 28 joints (DAS28) at 24 weeks post randomisation. Secondary outcome measures over 48 weeks were additional measures of disease activity, quality of life, cost-effectiveness, radiographic measures, safety and toxicity.

**Limitations:** Owing to third-party contractual issues, commissioning challenges delaying centre set-up and thus slower than expected recruitment, the funders terminated the trial early.

**Results:** Between July 2012 and December 2014, 149 patients in 35 centres were registered, of whom 122 were randomised to treatment (alternative TNFi,  $n = 41$ ; abatacept,  $n = 41$ ; rituximab,  $n = 40$ ). The numbers, as specified, were analysed in each group [in line with the intention-to-treat (ITT) principle]. Comparing alternative TNFi with rituximab, the difference in mean reduction in DAS28 at 24 weeks post randomisation was 0.3 [95% confidence interval (CI)  $-0.45$  to  $1.05$ ] in the ITT patient population and  $-0.58$  (95% CI  $-1.72$  to  $0.55$ ) in the per protocol (PP) population. Corresponding results for the abatacept and rituximab comparison were  $0.04$  (95% CI  $-0.72$  to  $0.79$ ) in the ITT population and  $-0.15$  (95% CI  $-1.27$  to  $0.98$ ) in the PP population. General improvement in the Health Assessment Questionnaire Disability Index, Rheumatoid Arthritis Quality of Life and the patients' general health was apparent over time, with no notable differences between treatment groups. There was a marked initial improvement in the patients' global assessment of pain and arthritis at 12 weeks across all three treatment groups. Switching to alternative TNFi may be cost-effective compared with rituximab [incremental cost-effectiveness ratio (ICER) £5332.02 per quality-adjusted life-year gained]; however, switching to abatacept compared with switching to alternative TNFi is unlikely to be cost-effective (ICER £253,967.96), but there was substantial uncertainty in the decisions. The value of information analysis indicated that further research would be highly valuable to the NHS. Ten serious adverse events in nine patients were reported; none were suspected unexpected serious adverse reactions. Two patients died and 10 experienced toxicity.

**Future work:** The results will add to the randomised evidence base and could be included in future meta-analyses.

**Conclusions:** How to manage first-line TNFi treatment failures remains unresolved. Had the trial recruited to target, more credible evidence on whether or not either of the interventions were non-inferior to rituximab may have been provided, although this remains speculative.

**Trial registration:** Current Controlled Trials ISRCTN89222125 and ClinicalTrials.gov NCT01295151.

**Funding:** This project was funded by the National Institute for Health Research (NIHR) Health Technology Assessment programme and will be published in full in *Health Technology Assessment*; Vol. 22, No. 34. See the NIHR Journals Library website for further project information.

# Contents

<b>List of tables</b>	<b>xiii</b>
<b>List of figures</b>	<b>xvii</b>
<b>List of boxes</b>	<b>xix</b>
<b>List of abbreviations</b>	<b>xxi</b>
<b>Plain English summary</b>	<b>xxiii</b>
<b>Scientific summary</b>	<b>xxv</b>
<b>Chapter 1 Introduction</b>	<b>1</b>
Background	1
The National Institute for Health and Care Excellence's rheumatoid arthritis management guidance	1
Biological therapies	1
<i>Tumour necrosis factor inhibitors</i>	2
<i>Non-tumour necrosis factor inhibitors</i>	2
The clinical unmet need	2
The National Institute for Health and Care Excellence's technology appraisal for biologic disease-modifying antirheumatic drugs	2
<i>Non-response to tumour necrosis factor inhibitor</i>	3
Switching between tumour necrosis factor inhibitors	3
<i>Observational studies</i>	3
<i>Randomised controlled trials</i>	3
Switching to non-tumour necrosis factor inhibitor biologic disease-modifying antirheumatic drug therapies	4
<i>Randomised controlled trials</i>	4
Switching to a second tumour necrosis factor inhibitor or alternative class biologic disease-modifying antirheumatic drug	4
<i>Observational studies</i>	4
<i>Head-to-head comparisons</i>	5
Serology and response	5
Additional clinical factors for consideration	5
Summary comments	6
<b>Chapter 2 Clinical trial methods</b>	<b>7</b>
Objectives	7
<i>Primary objective</i>	7
<i>Secondary objectives</i>	7
<i>Exploratory objectives</i>	7
Design	7
Patient and public involvement	8
Participants	8
<i>Recruitment</i>	10
Interventions	10
<i>Abatacept</i>	10

<i>Alternative tumour necrosis factor inhibitors</i>	10
<i>Rituximab (control)</i>	11
Study procedures	11
<i>Screening and baseline assessments</i>	11
<i>Intervention and observational phase assessments</i>	12
Outcome measures	12
<i>Primary outcome measure</i>	12
<i>Secondary outcome measures</i>	12
Safety monitoring	14
Patient withdrawal	14
Sample size and power calculation	14
Randomisation	15
Blinding	15
<i>Analysis</i>	15
<i>Patient populations</i>	16
<i>Missing data</i>	16
<i>Primary outcome measure</i>	16
<i>Key secondary outcome measures</i>	17
<i>Additional secondary outcome measures</i>	18
Summary of protocol amendments	18
<b>Chapter 3 Clinical trial results</b>	<b>19</b>
Patient recruitment	19
Recruitment target	19
Randomisation	19
<i>Generalisability of the patient population randomised</i>	22
Withdrawals	22
Protocol deviations	22
Treatment compliance	22
<i>Rituximab</i>	24
<i>Abatacept</i>	24
<i>Alternative tumour necrosis factor inhibitor</i>	24
Baseline characteristics	24
<i>Minimisation factors</i>	24
<i>Demographics</i>	27
<i>Treatment history</i>	27
<i>Baseline disease activity and individual component measures</i>	28
<i>Baseline patient-reported outcomes</i>	29
<i>Comparability of baseline characteristics between groups</i>	29
Primary and secondary outcomes	29
<i>Primary outcome</i>	29
<i>Exploratory subgroup analysis</i>	33
<i>Secondary outcomes</i>	35
<i>Additional secondary outcomes</i>	39
Safety	45
<i>Serious adverse events</i>	45
<i>Adverse events</i>	46
<b>Chapter 4 Health economic analysis</b>	<b>47</b>
Introduction	47
Methods	47
<i>Aim and end points</i>	47
<i>Perspective and time frame</i>	47

<i>Measurement of effectiveness</i>	47
<i>Measurement of costs</i>	48
<i>Missing data</i>	49
<i>Analysis</i>	49
Results	51
<i>Sample</i>	51
Resource use and costs	51
<i>Quality-of-life data</i>	56
<i>Missing data</i>	56
<i>Cost-effectiveness results</i>	58
<i>Net benefit</i>	60
<i>Sensitivity analysis</i>	60
<i>Secondary analyses</i>	60
<i>Value of information analysis</i>	64
Conclusions	64
<b>Chapter 5 Discussion</b>	<b>65</b>
Principal findings	65
<i>Primary outcome</i>	65
<i>Exploratory subgroup analysis</i>	65
<i>Secondary outcomes</i>	66
<i>Strengths and weaknesses</i>	66
Recruitment	68
Health economic evaluation	69
<i>Principal findings</i>	69
<i>Strengths and weaknesses of the economic analysis</i>	69
<i>Meaning of the study</i>	70
<i>Unanswered questions and further research</i>	70
Comparison with other studies	70
Implications for health care and future research	71
<b>Acknowledgements</b>	<b>73</b>
<b>References</b>	<b>77</b>
<b>Appendix 1 Participant information sheet and consent forms</b>	<b>89</b>
<b>Appendix 2 Participant health social care expenditure</b>	<b>101</b>
<b>Appendix 3 Study closure patient information sheet</b>	<b>107</b>
<b>Appendix 4 SWITCH study closure patient information Article for National Rheumatoid Arthritis Society web page and other relevant electronic forums</b>	<b>111</b>
<b>Appendix 5 Schedule of events for each treatment</b>	<b>113</b>
<b>Appendix 6 Disease activity response categories</b>	<b>123</b>
<b>Appendix 7 Statistical analysis plan</b>	<b>125</b>
<b>Appendix 8 Key protocol amendments</b>	<b>195</b>
<b>Appendix 9 Screening and withdrawals</b>	<b>197</b>

<b>Appendix 10</b> Per protocol population summary tables	<b>203</b>
<b>Appendix 11</b> Supplementary baseline data	<b>211</b>
<b>Appendix 12</b> Secondary outcomes	<b>215</b>
<b>Appendix 13</b> Data missingness	<b>237</b>
<b>Appendix 14</b> Safety line listings	<b>241</b>
<b>Appendix 15</b> Supplementary health economics tables	<b>269</b>

# List of tables

<b>TABLE 1</b> Trial treatment regimen by treatment arm	11
<b>TABLE 2</b> Summary of minimisation factors at baseline: ITT patient population	25
<b>TABLE 3</b> Summaries of patient characteristics at baseline: ITT patient population	25
<b>TABLE 4</b> Summary of treatment histories at baseline: ITT patient population	26
<b>TABLE 5</b> Summary of baseline disease activity: ITT patient population	27
<b>TABLE 6</b> Summaries of variables used as patient-reported outcomes measured at baseline: ITT patient population	28
<b>TABLE 7</b> Primary end-point analysis: multivariable linear regression analysis for a reduction in the DAS28 at 24 weeks post randomisation – ITT patient population	29
<b>TABLE 8</b> Adjusted mean reduction in the DAS28 and the corresponding difference between alternative TNFi, abatacept and rituximab at 24 weeks post randomisation – ITT patient population	30
<b>TABLE 9</b> Sensitivity analysis: adjusted mean reduction in DAS28 and corresponding difference between alternative TNFi, abatacept and rituximab at 24 weeks post randomisation – ITT patient population	31
<b>TABLE 10</b> Primary end-point analysis: multivariable linear regression analysis for a reduction in the DAS28 at 24 weeks post randomisation – PP population	32
<b>TABLE 11</b> Adjusted mean reduction in the DAS28 and corresponding difference between alternative TNFi, abatacept and rituximab at 24 weeks post randomisation – PP population	32
<b>TABLE 12</b> Adjusted mean reduction in the DAS28 and corresponding difference between alternative TNFi, abatacept and rituximab at 24 weeks post randomisation – complete-case population	33
<b>TABLE 13</b> Least squares means (95% CIs) of the DAS28 reduction at week 24 in each subgroup by treatment arm – ITT patient population	34
<b>TABLE 14</b> Estimated coefficients from a multivariable covariance pattern model for the DAS28 over 48 weeks post randomisation – ITT patient population	35
<b>TABLE 15</b> Adjusted mean (95% CI) DAS28 and comparisons of alternative TNFi and abatacept with rituximab by assessment time point over 48 weeks	36
<b>TABLE 16</b> Estimated coefficients for the multivariable covariance pattern model for the DAS28 response over 48 weeks post randomisation: ITT patient population	37
<b>TABLE 17</b> Adjusted odds of achieving a DAS28 response and the corresponding odds ratios over time	38

<b>TABLE 18</b> Multivariable logistic regression model for the ACR20 response at 24 weeks post randomisation: ITT patient population	<b>39</b>
<b>TABLE 19</b> Adjusted odds of an ACR20 response at 24 weeks post randomisation: ITT patient population	<b>39</b>
<b>TABLE 20</b> Frequency of non-SAEs reported by treatment group	<b>46</b>
<b>TABLE 21</b> Baseline characteristics of patients included in the complete-case analysis by treatment group	<b>52</b>
<b>TABLE 22</b> Average resource use per patient over the trial period in each treatment group (complete resource use data)	<b>53</b>
<b>TABLE 23</b> Mean health-care costs by trial arm (complete cost data)	<b>55</b>
<b>TABLE 24</b> Mean (SD) EQ-5D scores by treatment group and time point (complete outcome data)	<b>57</b>
<b>TABLE 25</b> Mean EQ-5D change from baseline to each follow-up time point for each trial arm	<b>57</b>
<b>TABLE 26</b> Total costs and QALYs for each treatment (complete-case data)	<b>58</b>
<b>TABLE 27</b> Cost-effectiveness results (bootstrap of complete-case data)	<b>58</b>
<b>TABLE 28</b> Net monetary benefit (= £20,000)	<b>60</b>
<b>TABLE 29</b> Sensitivity analyses: total costs and QALYs for each treatment (observed data)	<b>62</b>
<b>TABLE 30</b> Sensitivity analyses: cost-effectiveness results (bootstrapped data)	<b>62</b>
<b>TABLE 31</b> Secondary analyses: total costs and QALYs for each treatment (observed data)	<b>63</b>
<b>TABLE 32</b> Secondary analyses: cost-effectiveness results (bootstrapped data)	<b>63</b>
<b>TABLE 33</b> Schedule of events for rituximab	<b>114</b>
<b>TABLE 34</b> Schedule of events for infliximab	<b>117</b>
<b>TABLE 35</b> Schedule of events for subcutaneous treatments	<b>120</b>
<b>TABLE 36</b> DAS28 response categories	<b>123</b>
<b>TABLE 37</b> EULAR28 response criteria based on the Disease Activity Score	<b>123</b>
<b>TABLE 38</b> Clinical Disease Activity Index disease activity states	<b>124</b>
<b>TABLE 39</b> Simplified Disease Activity Index disease activity states	<b>124</b>



<b>TABLE 40</b> Summary of patients considered for inclusion in SWITCH, with status up to randomisation, including reasons for non-registration	198
<b>TABLE 41</b> Summary of reasons for ineligibility leading to patients not being approached for consent for the SWITCH trial	200
<b>TABLE 42</b> Summary of reasons for non-consent leading to patients not being approached for consent for the SWITCH trial	200
<b>TABLE 43</b> Summary of reasons given for ineligibility among the 19 patients who were registered but found to be ineligible following pre-randomisation tests	201
<b>TABLE 44</b> Summary of characteristics of patients who were considered for participation in the SWITCH trial	201
<b>TABLE 45</b> Listing of patient and clinician withdrawals	202
<b>TABLE 46</b> Summary of reasons for exclusion from the PP population	203
<b>TABLE 47</b> Minimisation factors: PP population	204
<b>TABLE 48</b> Demographic information: PP population	205
<b>TABLE 49</b> Disease and treatment history: PP population	206
<b>TABLE 50</b> Baseline disease activity: PP population	207
<b>TABLE 51</b> Baseline patient-reported outcomes: PP population	207
<b>TABLE 52</b> The DAS28 and corresponding improvement in DAS28 over 48 weeks: PP population	208
<b>TABLE 53</b> Summaries of the reduction in the DAS28 at week 24 for each of the exploratory subgroups: complete-case population	215
<b>TABLE 54</b> Frequency of patients achieving a DAS28 response (a reduction of 1.2 units or more from baseline) over 48 weeks: complete-case population	216
<b>TABLE 55</b> Covariance matrix of the unstructured covariance (95% CI) from mixed-effects model for the DAS28 over 48 weeks	216
<b>TABLE 56</b> Covariance matrix of the unstructured covariance (95% CI) from mixed-effects model for DAS28 response over 48 weeks	216
<b>TABLE 57</b> Frequency of patients achieving ACR20, ACR50 or ACR70 response at each follow-up until week 48: complete-case population	217
<b>TABLE 58</b> Summary statistics of the DAS28 and reduction in the DAS28 over time	217
<b>TABLE 59</b> The DAS28 category over time	219
<b>TABLE 60</b> The EULAR response over time	220

<b>TABLE 61</b>	The ACR/EULAR Boolean remission response over time	<b>222</b>
<b>TABLE 62</b>	Clinical Disease Activity Index, change in CDAI over time	<b>223</b>
<b>TABLE 63</b>	Clinical Disease Activity Index response over time	<b>225</b>
<b>TABLE 64</b>	Simplified Disease Activity Index, change in SDAI over time	<b>226</b>
<b>TABLE 65</b>	Simplified Disease Activity Index response over time	<b>228</b>
<b>TABLE 66</b>	The HAQ-DI, RAQoL and HADS scores over time	<b>230</b>
<b>TABLE 67</b>	Patient global assessment of pain, arthritis and general health over time	<b>233</b>
<b>TABLE 68</b>	Bone densitometry at baseline and 48 weeks	<b>236</b>
<b>TABLE 69</b>	Summary of component-level missingness for DAS28 and ACR response at all time points to week 48	<b>237</b>
<b>TABLE 70</b>	Summary of patient-level missingness for DAS28 components to week 48 and ACR response components to week 24 and 48	<b>239</b>
<b>TABLE 71</b>	Line listing of all serious ARs	<b>242</b>
<b>TABLE 72</b>	Line listing of all serious ARs	<b>243</b>
<b>TABLE 73</b>	Line listing of all SAEs (not related to IMP)	<b>243</b>
<b>TABLE 74</b>	Line listing of all SAEs (not related to IMP)	<b>245</b>
<b>TABLE 75</b>	Line listing of non-SAEs	<b>246</b>
<b>TABLE 76</b>	Resource use: unit costs	<b>269</b>
<b>TABLE 77</b>	Trial medication costs	<b>271</b>
<b>TABLE 78</b>	Trial drug administration costs	<b>272</b>
<b>TABLE 79</b>	Average resource use per patient in each trial arm	<b>273</b>
<b>TABLE 80</b>	Average health-care costs (£) by trial arm	<b>279</b>

# List of figures

<b>FIGURE 1</b> Manikin showing joints to be included in the SJC and TJC	<b>12</b>
<b>FIGURE 2</b> The flow of patients through the SWITCH trial (Consolidated Standards of Reporting Trials diagram)	<b>20</b>
<b>FIGURE 3</b> Graph showing actual recruitment and projected recruitment when the trial was terminated	<b>21</b>
<b>FIGURE 4</b> Summary of follow-up attendance up to the end of the 48-week intervention phase	<b>23</b>
<b>FIGURE 5</b> Primary end-point analysis: difference in mean reduction in the DAS28 at 24 weeks post randomisation between alternative TNFi, abatacept and rituximab – ITT population analysis	<b>30</b>
<b>FIGURE 6</b> Sensitivity analysis on the primary end point: difference in the mean reduction in the DAS28 at 24 weeks post randomisation between alternative TNFi, abatacept and rituximab	<b>31</b>
<b>FIGURE 7</b> Primary end-point analysis: difference in the mean reduction in the DAS28 at 24 weeks post randomisation between alternative TNFi, abatacept and rituximab – PP population	<b>32</b>
<b>FIGURE 8</b> Primary end-point analysis: difference in the mean reduction in the DAS28 at 24 weeks post randomisation between alternative TNFi, abatacept and rituximab – complete-case population	<b>34</b>
<b>FIGURE 9</b> Adjusted mean DAS28 over the 48-week intervention period and the comparisons of alternative TNFi and abatacept with rituximab over 48 weeks	<b>36</b>
<b>FIGURE 10</b> Adjusted odds of achieving a DAS28 response and odds ratios of a response over 48 weeks	<b>38</b>
<b>FIGURE 11</b> Odds ratios of an ACR20 response relative to rituximab at 24 weeks post randomisation: ITT patient population	<b>40</b>
<b>FIGURE 12</b> Box and whisker plot: HAQ-DI score over 48 weeks by treatment group	<b>41</b>
<b>FIGURE 13</b> Box and whisker plot: RAQoL over 48 weeks by treatment group	<b>42</b>
<b>FIGURE 14</b> Box and whisker plot: HADS anxiety scale over 48 weeks by treatment group	<b>42</b>
<b>FIGURE 15</b> Box and whisker plot: HADS depression scale over 48 weeks by treatment group	<b>43</b>
<b>FIGURE 16</b> Box and whisker plot: Patient Global Assessment of Pain over 48 weeks by treatment group	<b>43</b>

<b>FIGURE 17</b> Box and whisker plot: Patient Global Assessment of Arthritis over 48 weeks by treatment group	<b>44</b>
<b>FIGURE 18</b> Box and whisker plot: Patient Assessment of General Health over 48 weeks by treatment group	<b>44</b>
<b>FIGURE 19</b> Box and whisker plots of the distributions of the resource use costs by treatment group	<b>56</b>
<b>FIGURE 20</b> Scatterplot on the cost-effectiveness plane: alternative TNFi vs. rituximab and abatacept vs. TNFi	<b>59</b>
<b>FIGURE 21</b> Cost-effectiveness acceptability curve of an TNFi, rituximab and abatacept	<b>61</b>
<b>FIGURE 22</b> Expected value of perfect information: population	<b>64</b>

# List of boxes

**BOX 1** Derivation of the DAS28

**123**



## List of abbreviations

ACPA	anti-citrullinated peptide antibody	HADS	Hospital Anxiety and Depression Scale
ACR	American College of Rheumatology		
ACR20	American College of Rheumatology 20	HAQ	Health Assessment Questionnaire
		HAQ-DI	Health Assessment Questionnaire Disability Index
ACR50	American College of Rheumatology 50	HTA	Health Technology Assessment
ACR70	American College of Rheumatology 70	IB	investigator's brochure
AE	adverse event	ICER	incremental cost-effectiveness ratio
AR	adverse reaction	IgG1	immunoglobulin G 1
bDMARD	biologic disease-modifying antirheumatic drug	IL	interleukin
BNF	<i>British National Formulary</i>	IMP	investigational medicinal product
BSR	British Society of Rheumatology	IR	inadequate response
CCG	Clinical Commissioning Group	ITT	intention to treat
CDAI	Clinical Disease Activity Index	LTE	long-term extension study
CI	confidence interval	MTX	methotrexate
CRF	case report form	NB	net benefit
CRN	Clinical Research Network	NICE	National Institute for Health and Care Excellence
CRP	C-reactive protein	NIHR	National Institute for Health Research
csDMARD	conventional synthetic disease-modifying antirheumatic drug	NMB	net monetary benefit
CZP	certolizumab pegol	NSAID	non-steroidal anti-inflammatory drug
DAS28	Disease Activity Score of 28 joints	PP	per protocol
DMARD	disease-modifying antirheumatic drug	PPI	patient and public involvement
ECG	electrocardiography	PSSRU	Personal Social Services Research Unit
eMit	electronic market information tool	QALY	quality-adjusted life-year
EQ-5D	EuroQol 5 Dimensions	RA	rheumatoid arthritis
EQ-5D-3L	EuroQol 5 Dimensions, 3 levels	RAQoL	Rheumatoid Arthritis Quality of Life
ESR	erythrocyte sedimentation rate	RCT	randomised controlled trial
EULAR	European League Against Rheumatism	rDNA	recombinant deoxyribonucleic acid
EVPI	expected value of perfect information	REFLEX	randomised valuation of long-term efficacy of rituximab in rheumatoid arthritis study
GP	general practitioner	RF	rheumatoid factor

## LIST OF ABBREVIATIONS

SAE	serious adverse event	TB	tuberculosis
SD	standard deviation	TJC	tender joint count
SDAI	Simplified Disease Activity Index	TNF	tumour necrosis factor
SJC	swollen joint count	TNFi	tumour necrosis factor inhibitor
SmPC	summary of product characteristics	VAS	visual analogue scale
SSAR	suspected serious adverse reaction		
SUSAR	suspected unexpected serious adverse reaction		



## Plain English summary

**R**heumatoid arthritis (RA) is a long-term problem that causes pain and swelling (inflammation) in the joints. Many patients need treatment with drugs known as biologics, usually starting with a group known as TNFi. If patients do not respond to a TNFi, the National Institute for Health and Care Excellence currently recommends another biologic, rituximab, but again not all will respond.

The aim of the SWITCH trial was to find out whether or not two alternative biologics (alternative TNFi or abatacept) were as good as rituximab at improving disease activity, quality of life, safety and cost-effectiveness in patients who did not respond to their initial TNFi treatment.

Between July 2012 and December 2014, 122 patients from 35 hospitals were recruited into the trial and randomly put into three treatment groups (1) rituximab, (2) alternative TNFi or (3) abatacept. We planned to recruit 477 patients into the SWITCH trial. The trial was stopped early because of slow recruitment (largely attributable to operational challenges throughout the study period), achieving only 122 patients enrolled, and as a result was too small to test if either drug works as well as rituximab in reducing disease activity. A similar general improvement in patients' physical functioning, quality of life relating to their RA, general health and safety over the 12-month period was apparent for all three treatments.

Switching to alternative TNFi may be cost-effective compared with the current treatment; however, the use of abatacept is unlikely to be cost-effective.

Alternative options to rituximab may work in patients who do not respond to their first biologic therapy, but uncertainty remains about which treatments to choose following an initial TNFi treatment failure.



# Scientific summary

## Background

Rheumatoid arthritis (RA) is a chronic systemic inflammatory arthritis that affects 0.8% of the UK population. RA has a considerable impact on health and socioeconomics as a result of hospitalisation and loss of employment, with over 50% of patients work-disabled within 10 years of diagnosis. The National Institute for Health and Care Excellence (NICE)'s guidance recommends commencement of conventional synthetic disease-modifying antirheumatic drugs (csDMARDs) on diagnosis, usually methotrexate (MTX) and/or additional csDMARDs. If patients fail to respond to these and demonstrate high disease activity [i.e. Disease Activity Score of 28 joints (DAS28) of  $> 5.1$ ], NICE recommends the use of biologic disease-modifying antirheumatic drugs (bDMARDs). Four different classes of bDMARD are available. Tumour necrosis factor inhibitor (TNFi) (of which there are five different drugs) is the most commonly used. However, up to 30–40% of patients fail to respond or lose an initial response to this bDMARD. In this setting, of the other three classes of bDMARD available, NICE recommends use of only rituximab, which not all patients respond to. This guidance thus limits the use of other potentially effective treatments (alternative TNFi, abatacept and tocilizumab) and is in the absence of any direct trial comparisons.

The ambition of the SWITCH randomised trial was to deliver a definitive trial that would be a paradigm shift in the RA community, delivering the largest RA pragmatic trial undertaken in the UK and thus also establishing a UK-wide research network on which to build future studies. The specific aim of the SWITCH trial was to provide clear guidance on successive bDMARD use to clinicians by assessing whether or not alternative class bDMARDs were comparable in efficacy and safety outcomes with rituximab, the NICE-preferred second-line option. The results of this study were expected to contribute to the development of a treatment algorithm for clinically effective and cost-effective management, in particular to inform individualised treatment regimens as opposed to a blanket switching of all patients to a single (and potentially unsuccessful and toxic) therapy.

## Objectives

The primary objective was to determine whether or not an alternative-mechanism TNFi or abatacept (Orencia®; Bristol-Myers Squibb, New York City, NY, USA) was non-inferior to rituximab (MabThera; Roche, Basel, Switzerland) in disease response at 24 weeks post randomisation in patients with RA who had failed to respond to an initial TNFi and concomitant MTX (because of inefficacy).

The secondary objectives were to compare alternative TNFi and abatacept with rituximab with respect to disease response, quality of life, toxicity and safety over 48 weeks; to undertake an evaluation of the cost-effectiveness of switching patients to alternative TNFi (abatacept or rituximab); and, finally, to compare structural and bone density outcomes for abatacept and alternative TNFi to rituximab over 48 weeks using plain radiography and bone densitometry score.

Exploratory objectives were to determine the optimal sequence of treatments by assessing whether or not the response to the second treatment in patients with RA is affected by which of the initial TNFi groups the patients failed, to evaluate if the response to the second treatment is affected by whether or not the patient was a primary or secondary response failure to their initial TNFi therapy and, finally, to ascertain whether or not seropositive [to either or both of rheumatoid factor (RF) and anti-citrullinated peptide antibody (ACPA)] and seronegative (RF and ACPA negative) RA patients behave differently in their response and disease outcome measures in the three treatment arms. These exploratory objectives represented more unique aspects of the trial that held particular clinical relevance.

## Methods

### Design

The SWITCH study was a multicentre, Phase III, open-label, non-inferiority, three-arm randomised controlled trial comparing the clinical effectiveness and cost-effectiveness of alternative TNFi and abatacept with that of rituximab in patients with RA who have failed to respond to an initial TNFi drug (with concomitant MTX).

Patients were randomised (1 : 1 : 1) to receive alternative TNFi [etanercept (if initial treatment with a monoclonal antibody failed) or a monoclonal antibody of the clinician's choice (if initial treatment with etanercept failed)], abatacept or rituximab (and concomitant MTX), via a minimisation programme incorporating a random element, with minimisation factors centre, disease duration, non-response category seropositive/negative status. Patients received randomised treatment during the interventional phase to a maximum of 48 weeks and were then subsequently followed up to a maximum of 96 weeks in the observational phase.

### Setting

The study took place in outpatient rheumatology departments in 35 hospitals throughout the UK.

### Participants

Patients diagnosed with RA who were receiving MTX, had not responded to at least two csDMARD therapies, including MTX, and had experienced inadequate response to treatment with one TNFi; these eligibility criteria were based on the NICE and British Society of Rheumatology (BSR)'s guidelines on the use of first-line TNFi.

### Interventions

Rituximab (control) is a genetically engineered chimeric (human–murine) monoclonal antibody against the B-cell protein marker CD20.

Abatacept is a selective T-cell co-stimulation blocking agent that is a fusion protein composed of the Fc region of the immunoglobulin G1 (IgG1) fused to the extracellular domain of cytotoxic T-lymphocyte-associated protein 4 (CTLA-4).

Alternative TNFi was etanercept (Enbrel®; Pfizer, New York City, NY, USA) [a human TNF receptor–p75Fc fusion protein produced by recombinant deoxyribonucleic acid (rDNA) technology] or a TNF monoclonal antibody. The specific monoclonal antibodies used were at the discretion of the treating clinician but they were restricted to one of adalimumab (HUMIRA®; Abbott, now AbbVie, North Chicago, IL, USA) (a recombinant fully human IgG1 monoclonal antibody specific for TNF), certolizumab pegol (CIMZIA®; UCB, Brussels, Belgium) [a recombinant (Fc-free) humanised antibody Fab' fragment against TNF and conjugated to polyethylene glycol], infliximab (REMICADE®; Janssen Pharmaceutical, Beerse, Belgium) (a chimeric human–murine IgG1 monoclonal antibody produced by rDNA technology) or golimumab (SIMPONI®; Janssen Pharmaceutical) (a fully human IgG1 monoclonal antibody to TNF).

### Outcome measures

The primary outcome measure was the absolute reduction in DAS28 at 24 weeks post randomisation. DAS28 is a composite score calculated as a function of the number of tender and swollen joints, the erythrocyte sedimentation rate and the patient's global assessment of their arthritis.

Secondary outcome measures over 48 weeks were additional measures of disease activity [a reduction in DAS28 of  $\geq 1.2$ , low disease activity rate and remission rate, European League Against Rheumatism (EULAR) and American College of Rheumatology (ACR) response, ACR/EULAR Boolean remission, Clinical Disease Activity Index and Simplified Disease Activity Index] and patient-reported outcome measures [Rheumatoid Arthritis Quality of Life (RAQoL), Hospital Anxiety and Depression Scale (HADS), Health

Assessment Questionnaire Disability Index (HAQ-DI) and global assessment of pain, arthritis and general health using visual analogue scales]. The outcomes required for the cost-effectiveness analysis were the EuroQol 5 Dimensions, 3 levels (EQ-5D-3L), and health- and social-care resource use attributable to RA. In addition, radiographic outcome measure and bone densitometry T-scores of the neck of femur and lumbar spine were included. Further outcomes related to safety (adverse events and reactions) and toxicity (requiring cessation of treatment) were reported throughout the trial treatment.

### Sample size

A total of 477 patients was required for the sample to have 80% power for demonstrating non-inferiority, at 95% confidence, of either abatacept or alternative TNFi to rituximab in the mean reduction in DAS28 at 24 weeks post randomisation, assuming a non-inferiority limit of  $-0.6$  units, no difference between treatment groups, a between-patient standard deviation (SD) of 1.8 units and loss to follow-up of 10%.

### Analysis

An analysis of the primary outcome measure was completed for the intention-to-treat (ITT), per protocol (PP) and complete-case populations. Non-inferiority was defined as the lower limit of the 95% confidence interval (CI) lying above  $-0.6$  units in both the ITT and PP populations. An analysis of secondary outcome measures was undertaken on the ITT and complete-case populations as appropriate. Safety data are summarised on the safety population.

Multiple imputation by chained equations was used to impute missing values at the component level for the DAS28 and American College of Rheumatology 20 (ACR20), under the assumption that the data were 'missing at random'. Parameter estimates across each of the fully imputed data sets were combined using Rubin's rules.

A mixed-effects linear regression model was fitted to the primary outcome measure with covariates corresponding to the minimisation factors and treatment group. Centre was fitted as a random effect.

Covariance pattern models were fitted to the DAS28 and the binary marker (logit link) of a reduction in DAS28 of  $\geq 1.2$  units over time with covariates entered for the minimisation factors (excluding centre), baseline DAS28, treatment group, time and time-by-treatment interaction. A logistic regression model was fitted to the ACR20 at 24 weeks post randomisation, with covariates entered for the minimisation factors (excluding centre) and treatment group. All additional secondary outcome measures, including further measures of disease activity and quality of life, the exploratory subgroup analyses to evaluate the treatment modification effect of RF/ACPA status, non-response category and initial TNFi group failed on and DAS28 at 24 weeks, are summarised by treatment group and compared informally using descriptive statistics. In addition, treatment compliance, toxicity and safety were summarised.

For the primary cost-effectiveness analysis, total cost and quality-adjusted life-years (QALYs) over the 48-week time horizon and corresponding incremental cost-effectiveness ratios (ICERs) were calculated for each treatment group. For the secondary analysis, a wider cost perspective was adopted to include the total costs incurred by patients.

## Results

Between July 2012 and December 2014, when the trial was stopped, 149 patients in 35 centres were registered in the trial, of whom 122 were randomised to treatment.

Comparing alternative TNFi with rituximab, the difference in mean reduction in DAS28 at 24 weeks post randomisation was 0.3 (95% CI  $-0.45$  to 1.05) in the ITT population and  $-0.58$  (95% CI  $-1.72$  to 0.55) in the PP population.

The corresponding results for the comparison of abatacept and rituximab were 0.04 (95% CI -0.72 to 0.79) in the ITT population and -0.15 (95% CI -1.27 to 0.98) in the PP population.

There was evidence of a statistically significant difference in DAS28 at week 36 ( $p = 0.022$ ) between alternative TNFi and rituximab, with a lower DAS28 in the TNFi arm, but this difference was not maintained at week 48. There was no evidence of a clinically or statistically significant difference in DAS28 for abatacept compared with rituximab at any time point. There was no statistically significant difference in the odds of achieving a DAS28 response (i.e. reduction of  $\geq 1.2$ ) for either intervention compared with rituximab at any of the time points. Moreover, there was no evidence of a difference in the odds of achieving an ACR20 response at 24 weeks post randomisation for either intervention relative to rituximab.

Overall, a general improvement in HAQ-DI, RAQoL and the patients' general health was apparent over time, with no notable differences between treatment groups. There was a marked initial improvement in the average global assessment of pain and arthritis at 12 weeks for all three treatment groups. Small improvements in the HADS scores sustained over the 48-week period were observed for alternative TNFi and abatacept, whereas no notable improvement was apparent for rituximab.

Ten serious adverse events (SAEs) were reported in nine patients, of which three events in three patients were considered to be related to trial medications. No suspected unexpected serious adverse reactions were reported. Two patients died, both following the development of a SAE (rituximab, abatacept), one of which was a suspected serious adverse reaction (abatacept). Ten patients experienced toxicity resulting in a permanent cessation of treatment (four patients on alternative TNFi, two on abatacept and four on rituximab).

The health economic analysis suggested that switching to alternative TNFi may be cost-effective compared with rituximab [mean cost alternative TNFi, £9680.23 (SD £1263.71); mean cost rituximab, £9367.27 (SD £3215.13); mean QALY alternative TNFi, 0.52 (SD 0.14); mean QALY rituximab, 0.46 (SD 0.18); ICER, £5332.02 per QALY gained]; however, switching to abatacept compared with switching to alternative TNFi is unlikely to be cost-effective [mean cost abatacept, £13,475.09 (SD £4173.22); mean QALY abatacept, 0.53 (SD 0.17); ICER, £253,367.96] when considered against the NICE cost/QALY acceptance threshold of £20,000. The value of information analysis indicated that it would be highly valuable to the NHS to reduce the current uncertainty regarding the effectiveness of alternative TNFi compared with rituximab in the management of RA.

## Conclusions

### *Implications for health care*

The clinical question of whether or not alternative bDMARDs and rituximab are comparable in efficacy and safety outcomes in patients with RA who had not responded adequately to an initial TNFi bDMARD and MTX remains unresolved. The lack of evidence, which is based on a single treatment (rituximab) being appropriate for all patients, limits guidance options.

Had the study been extended to enable recruitment to target, definitive evidence on whether or not either of the interventions were non-inferior to rituximab may have been provided, which may have opened up further treatment options for patients.

## Trial registration

This trial is registered as ISRCTN89222125 and NCT01295151.

## Funding

Funding for this study was provided by the Health Technology Assessment programme of the National Institute for Health Research.





# Chapter 1 Introduction

## Background

Rheumatoid arthritis (RA), the most common autoimmune disease in the Western world,<sup>1</sup> is a chronic and systemic inflammatory arthritis that affects 0.8% of the UK population.<sup>2</sup> RA is the largest cause of treatable disability in the Western world.<sup>3,4</sup> Patients with RA suffer considerable pain, stiffness and swelling and, if not adequately controlled, sustain various degrees of joint destruction, deformity and significant functional decline. RA has a considerable health and socioeconomic impact, as a result of both hospitalisation and loss of employment, with over 50% of patients work-disabled within 10 years of diagnosis.<sup>5-7</sup>

Rheumatoid arthritis is associated with significant comorbidity and increased mortality compared with the general population,<sup>8</sup> largely because the prevalence of premature cardiovascular disease<sup>9</sup> is as high as that seen in patients with other major cardiovascular disease risk factors, such as type 2 diabetes,<sup>10</sup> and, in fact, is the cause of death of 48% of patients with RA. RA-related inflammation and disease activity over time are associated with increased cardiovascular disease risk in patients with RA,<sup>11-14</sup> which further emphasises the importance of ensuring optimal and effective disease control.

As compared with other chronic diseases, such as hypertension and type 2 diabetes, treatment of RA previously employed a gradual 'step-up' strategy with the use of conventional synthetic disease-modifying antirheumatic drugs (csDMARDs).<sup>15</sup> The concept of the ability to modify disease course started to be realised in the 1990s,<sup>16</sup> with key studies demonstrating the importance of early diagnosis and expedient implementation of csDMARD therapy,<sup>17-19</sup> which remain the cornerstones of management of RA. These paradigms have been consolidated by strategy trials and meta-analysis on the radiographic benefit.<sup>20-24</sup>

## The National Institute for Health and Care Excellence's rheumatoid arthritis management guidance

The National Institute for Health and Care Excellence (NICE)'s clinical guidance for the management of RA<sup>25</sup> recommends, in people with newly diagnosed active RA, a combination of csDMARDs [including methotrexate (MTX) and at least one other csDMARD, plus short-term glucocorticoids] as first-line treatment as soon as possible, ideally within 3 months of the onset of persistent symptoms (and within 6 weeks of diagnosis by a rheumatologist).

Methotrexate is thus recommended as the optimal first-line treatment strategy<sup>25,26</sup> either as monotherapy or in combination. Nevertheless, it had become clear that poor response (even if initially effective) remained a feature with most csDMARDs over time, with progression of joint damage and functional decline. In addition, a high incidence of toxicity has been observed with these drugs.<sup>27</sup> Such obstacles to therapy, combined with data suggesting limited alteration in long-term outcome, even in those patients showing a response, are an argument for more effective therapy.<sup>28</sup>

## Biological therapies

This unmet clinical need fuelled continued research into our understanding of RA, which led to significant advances by the 1990s. Inflammation was recognised to be a result of imbalance between pro-inflammatory cytokines such as tumour necrosis factor (TNF) alpha [as well as interleukin 1(IL-1), IL-6 and others] and anti-inflammatory cytokines such as IL-4 and IL-10. In RA, an excess of pro-inflammatory cytokines, in particular TNF and IL-1, has been shown to be responsible for disrupting this balance towards continued inflammation

and cartilage and bone damage, and thus critical in driving RA pathogenesis.<sup>29</sup> This understanding was complemented with significant advances in biotechnology. Following in vitro and in vivo work, the most compelling evidence for a key role for TNF stemmed from studies in which marked clinical benefit was observed in patients with RA treated with a chimeric anti-TNF monoclonal antibody.<sup>30</sup> The subsequent introduction of several costly, but highly effective, tumour necrosis factor inhibitor (TNFi) therapies marked the start of a new era in biologic disease-modifying antirheumatic drug (bDMARD) development for RA.<sup>31–33</sup>

### **Tumour necrosis factor inhibitors**

Tumour necrosis factor inhibitor drugs [etanercept (Enbrel®; Pfizer, New York City, NY, USA), infliximab (REMICADE®; Janssen Pharmaceutical, Beerse, Belgium), adalimumab (HUMIRA®; Abbott, now AbbVie, North Chicago, IL, USA), certolizumab pegol (CZP) (CIMZIA®; UCB, Brussels, Belgium) and golimumab (Simponi®; Janssen Pharmaceutical)] in combination with MTX produce better outcomes in RA than in placebo or treatment with MTX alone.<sup>31–37</sup> TNFi drugs, however, differ in several respects:

- i. molecule type [chimeric (mouse–human) monoclonal antibody (infliximab), fully human monoclonal antibody (adalimumab, golimumab), pegylated Fab fragment of a humanised monoclonal antibody (CZP) and a TNF receptor fusion protein (etanercept)]<sup>38</sup>
- ii. target (etanercept binds both TNF and another cytokine, lymphotoxin alpha)<sup>39</sup>
- iii. binding affinity to TNF
- iv. mechanism of drug action<sup>40–42</sup>
- v. clinical administration (intravenous vs. subcutaneous).

### **Non-tumour necrosis factor inhibitors**

Following the development of TNFis, recognition of other key cytokines and immune cells in RA pathogenesis<sup>43</sup> led to the development of additional bDMARDs: rituximab (MabThera; Roche, Basel, Switzerland), a chimeric anti-CD20-depleting monoclonal antibody,<sup>44</sup> tocilizumab (Actemra®; Roche, an IL-6 receptor monoclonal antibody<sup>45</sup> and abatacept (Orencia®; Bristol-Myers Squibb, New York City, NY, USA), a recombinant fusion protein T-cell co-stimulation blocking agent.<sup>46</sup> All of these bDMARDs demonstrated significant benefits compared with placebo and MTX in MTX-inadequate response<sup>44,47,48</sup> and TNFi-inadequate response<sup>49–51</sup> groups, respectively.

## **The clinical unmet need**

Tumour necrosis factor inhibitor is the most frequently used first-line bDMARD. Despite the extensive benefits of TNF-directed bDMARDs, a significant proportion, 20–40%, of patients with RA who have MTX-inadequate response and treated with TNFi<sup>52</sup> fail to achieve sufficient response (primary non-response) or lose responsiveness over time (secondary non-response).<sup>36,52</sup>

Thus, following initial TNFi-inadequate response, two broad approaches could theoretically be employed to manage patients: switching to alternative TNFi therapy or switching to a bDMARD with another mode of action.<sup>26</sup>

## **The National Institute for Health and Care Excellence's technology appraisal for biologic disease-modifying antirheumatic drugs**

At the time of the SWITCH study, a NICE technology appraisal recommended TNFi use if disease is severe, that is, a Disease Activity Score of 28 joints (DAS28) of > 5.1 units and disease has not responded to at least two conventional disease-modifying antirheumatic drugs (DMARDs), including MTX. Initially, adalimumab, etanercept and infliximab<sup>53</sup> (and later on CZP<sup>54</sup> and golimumab<sup>55</sup>) were recommended by NICE as first-line bDMARD therapy for the treatment of patients with RA who had failed to respond to, or had been intolerant of, at least two csDMARDs including MTX.<sup>56</sup>

The current NICE technology appraisal 375<sup>56</sup> has updated possible first-line bDMARD options and now recommends use not only of one of the five TNFi, but also of tocilizumab<sup>57</sup> and abatacept,<sup>58</sup> which are also approved by NICE for first-line bDMARD therapy following MTX-inadequate response.<sup>58</sup> Nevertheless, TNFi remains the most frequently used first-line bDMARD (both in the UK and worldwide).

### **Non-response to tumour necrosis factor inhibitor**

In the context of first-line bDMARD TNFi failure, NICE guidance recommends using rituximab as second-line bDMARD.<sup>59</sup> Switching to alternative TNFi, abatacept or tocilizumab, is permitted only if patients have had an inadequate response to rituximab<sup>57</sup> or are intolerant of rituximab<sup>57,59</sup> or if rituximab is contraindicated.<sup>57,59</sup> This is in the absence of any trial data demonstrating that rituximab is more appropriate than the alternative bDMARDs. Of note is the fact that this technology appraisal guidance applies to bDMARD use with background MTX. For individuals who are unable to take MTX, TNFi switching is permitted. This guidance has not been comprehensively updated following approval of tocilizumab and abatacept as first-line bDMARDs.

It is the absence of robust trial data to support NICE's guidance regarding the process to follow in the event of failure of initial TNFi treatment (discussed below), effectively limiting the treatment choice to rituximab, which we recognise is not effective for all individuals, that is the basis for the SWITCH study.

## **Switching between tumour necrosis factor inhibitors**

### **Observational studies**

Several early-phase uncontrolled studies and an initial small randomised study suggested benefit in switching between TNFi agents.<sup>60–70</sup> A report of extremely high responses on alternative TNFi agent in specific subgroups of patients<sup>62</sup> also indicated the potential value and the need to explore this approach further. A literature review<sup>71</sup> documented 29 reports on switching from one TNFi to another in RA, with the data largely indicating benefit of switching from a first TNFi to a second, with switching for secondary non-response likely to be more effective. A systematic review reported similar findings.<sup>72</sup>

### **Randomised controlled trials**

No randomised controlled trials (RCTs) of switching between adalimumab, etanercept and infliximab have been conducted in patients in whom these three established TNFi have failed. The rationale and argument for switching between different TNFi drugs, however, were further strengthened by a large, international, multicentre, randomised, Phase II study<sup>73</sup> that investigated 461 patients who had previously received and either failed or were intolerant of one or more TNFis. Patients were randomised to either golimumab (50 mg or 100 mg every 4 weeks) or placebo. American College of Rheumatology 20 (ACR20) response rates at week 14 were significantly higher in the golimumab groups than in the placebo group (35% and 38% vs. 18%, respectively). More recently, two RCT studies,<sup>74,75</sup> one with open-label evaluation,<sup>74</sup> have demonstrated significant efficacy of CZP in prior TNFi treatment failures. In a small but first prospective RCT,<sup>74</sup> patients in whom an initial TNFi was stopped because of secondary non-response (i.e. the initial response to the TNFi was lost) were randomised to 12 weeks of either CZP ( $n = 27$ ) or placebo ( $n = 10$ ), followed by an open-label CZP 12-week period. The primary end point was the proportion of patients reaching an ACR20 response by week 12, observed in 61.5% of patients in the CZP group, compared with 0% of patients in the placebo group. Placebo patients who were switched blindly to CZP attained similar results seen with CZP in weeks 0–12. As this result was highly significant, study inclusion was terminated after entry of 33.6% of the originally planned 102 patients. The REALISTIC study, a 28-week Phase IIIb study, assessed safety and maintenance of response to CZP in a diverse population of RA patients, stratified by prior TNFi exposure, concomitant MTX use and disease duration.

## Switching to non-tumour necrosis factor inhibitor biologic disease-modifying antirheumatic drug therapies

### *Randomised controlled trials*

Randomised controlled trials<sup>49-51</sup> and their long-term extension studies (LTEs)<sup>76-78</sup> have demonstrated the benefits of non-TNFi bDMARDs over placebo/MTX following TNFi-inadequate response.

The randomised evaluation of long-term efficacy of rituximab in RA (REFLEX) study evaluated the efficacy of rituximab versus placebo in patients receiving MTX who had failed at least one TNFi.<sup>49</sup> Significantly more rituximab-treated patients than placebo-treated patients achieved ACR20, American College of Rheumatology 50 (ACR50), American College of Rheumatology 70 (ACR70) and moderate to good European League Against Rheumatism (EULAR) responses at week 24. Of note, despite a significant reduction in Disease Activity Score in the rituximab group, the mean DAS28 at week 24 was still high, at 5.1 units (a reduction of 1.83 from 6.9 at baseline).<sup>49</sup> In the LTE study (and thus a selected subgroup), rituximab showed sustained effects on joint damage progression.<sup>76</sup> The ATAIN (A Therapeutic Trial of Afatinib In the Neoadjuvant Setting) study<sup>51</sup> compared the efficacy of abatacept and placebo/MTX in patients with TNFi-inadequate response and found that significantly more patients in the abatacept group achieved ACR20, ACR50 and ACR70 responses, impressive quality-of-life results and improvement in DAS28 (a reduction in Disease Activity Score of > 1.2 in 70% in the abatacept group vs. 18.2% in the placebo group)<sup>51</sup> and patients continued to maintain these improvements throughout the 2-year LTE study.<sup>77</sup> The RA study in anti-TNF failures (RADIATE) study compared the efficacy of tocilizumab (8 mg/kg or 4 mg/kg) plus MTX to placebo plus MTX in patients with one or more TNFi-inadequate responses.<sup>50</sup> At week 24, more patients in the tocilizumab groups than in the placebo group achieved ACR20, ACR50 and ACR70 responses and good or moderate EULAR responses.<sup>50</sup> The efficacy of tocilizumab was maintained for up to 4.2 years during the LTE study.<sup>78</sup>

## Switching to a second tumour necrosis factor inhibitor or alternative class biologic disease-modifying antirheumatic drug

### *Observational studies*

A number of observational studies have compared clinical response after switching to either rituximab or alternative TNFi in patients who failed initial TNFi treatment.<sup>79-82</sup> As summarised below, most have suggested better efficacy on switching to rituximab, although there are also reports of equivalent clinical responses in patients who switched to either alternative TNFi or rituximab following failure of one or more TNFi therapies.<sup>83,84</sup> These observational studies, however, had several design limitations, such as small sample sizes,<sup>79</sup> selection bias,<sup>79-82</sup> pooling all causes of TNFi failure<sup>81</sup> and missing data,<sup>79-82</sup> although they tried to address these issues by calculating propensity scores and using multivariable analysis techniques.<sup>79-82</sup>

Analysis of patients with RA in the Swiss Clinical Quality Management in Rheumatic Diseases RA registry (SCQM-RA),<sup>79,80</sup> who had treatment failure with at least one TNFi and were switched either to alternative TNFi or to one cycle of rituximab, showed that switching to rituximab may be more effective than switching to another TNFi. Furthermore, when the motive for switching was ineffectiveness of the TNFi, patients who received rituximab achieved a significantly better improvement in DAS28 at 6 months than patients who received alternative TNFi.<sup>80</sup> However, when the reason for switching was other causes, the improvement in DAS28 was similar in the two groups.<sup>80</sup> The same registry also reported that rituximab was as effective as alternative TNFi in preventing joint erosions in patients who had previous treatment failure with a TNFi.<sup>83</sup> A study of 1300 patients with RA on the British Society of Rheumatology (BSR)'s Biologics Register who had a failed response to their first TNFi treatment and were switched to a single cycle of either rituximab or alternative TNFi found that patients who switched to rituximab had better EULAR responses and were more likely to achieve improvement in their Health Assessment Questionnaire (HAQ) scores.<sup>81</sup> More recently, a global observational real-life study (SWITCH-RA)<sup>82</sup> also showed that among patients with RA who failed to respond to, or were intolerant of, a single previous TNFi, those who were switched to rituximab achieved significantly better clinical responses at 6 months than those patients who were switched to a second TNFi.

However, further subgroup analysis showed that these differences were observed only in seropositive [to either or both of rheumatoid factor (RF) and anti-citrullinated peptide antibody (ACPA)] patients who switched because of lack of efficacy of the first TNFi.<sup>82</sup>

An observational study from the US Consortium of Rheumatology Researchers of North America (CORRONA) cohort<sup>85</sup> reported clinical effectiveness of abatacept versus subsequent TNFi in patients with RA following one or more TNFi drug failures, using propensity scoring to reduce bias attributable to systematic prescribing practices. Six- and/or 12-month response outcomes with change in disease activity, remission rates based on the Clinical Disease Activity Index (CDAI) and modified DAS28 (mDAS28) and American College of Rheumatology (ACR) response rates were evaluated. The main analysis included all patients regardless of the reason for switching in the main analysis, with inadequate response to prior TNFi addressed in a sensitivity analysis. For the primary outcome (minimum clinically important difference in the change in CDAI score of 4.3) and the secondary outcomes, no differences between the two treatments were recorded.

### Head-to-head comparisons

Gottenberg *et al.*<sup>86</sup> reported a 52-week pragmatic open-label RCT that randomised 300 patients who did not respond to a first TNFi to receive either alternative TNFi or an alternative-mechanism bDMARD (abatacept, rituximab or tocilizumab). This was a superiority trial, with the primary outcome of a good or moderate EULAR response at 6 months. Primary outcome was achieved in a significantly greater proportion of patients in the non-TNFi group, with 70% achieving a good or moderate EULAR response, compared with 52% in the second TNFi group. Similar differences were observed from week 12 and persisted at week 52, with, in addition, significantly better low disease activity and remission rates. Although an instructive and randomised study, the multiple treatment options included within the non-TNFi group limit the extent to which these data can inform on which specific targeted agent should be considered.

In contrast, a recent preliminary report from a Dutch randomised trial of 144 patients with RA who had failed a first TNFi and were randomised (1 : 1 : 1) to receive alternative TNFi, abatacept or rituximab, showed that there was comparable improvement in the DAS28, HAQ scores and Short Form questionnaire-36 items (SF-36) outcome measures over a 12-month period.<sup>87</sup> Rituximab therapy was the most cost-effective of the three (although this finding may not be true in other countries with different health-care provision and pricing structures).<sup>87</sup> Further studies with larger sample sizes and inclusion of tocilizumab in the treatment options are needed to confirm these results.

### Serology and response

Compared with rituximab, and potentially the other two non-TNFi bDMARDs, a key benefit of the TNFi appears to be its suitability in both seropositive (either or both of RF and ACPA positive) and particularly seronegative disease.<sup>82</sup> Seronegative antibody status (seen in up to 25–30% of patients with RA) is associated with a poorer response to rituximab<sup>84,88,89</sup> and better response rates have been demonstrated in antibody-positive patients treated with rituximab, which was most evident in the TNFi failure group;<sup>84</sup> perhaps intuitive in the light of its target and rationale for use. Recent studies have also demonstrated that abatacept may be more effective in seropositive (ACPA-positive) patients.<sup>90–93</sup> Furthermore, a Japanese study of 58 patients with RA treated with tocilizumab (including 22 patients who previously received a TNFi) reported that a high titre of immunoglobulin M RFs at baseline was the only variable to be associated with CDAI remission at 24 weeks.<sup>94</sup> However, a larger French cohort study<sup>95</sup> of 208 patients with RA did not find an association between seropositivity at baseline and a EULAR response after 24 weeks of tocilizumab therapy.

### Additional clinical factors for consideration

Apart from antibody status, certain patients will not be appropriate for rituximab therapy, and coexisting pathologies, such as inflammatory bowel disease and psoriasis, that are also treated with TNFi may make

other agents less appropriate. Rituximab, for example, has been associated with the development of psoriasis in patients with no previous history of the disease,<sup>96</sup> although it is recognised that bDMARDs, including TNFi therapy, can induce paradoxical clinical manifestations such as pustular psoriasis.<sup>97,98</sup>

## Summary comments

Despite the benefits of recent advances in the management of RA, no universally effective treatment exists. It remains unclear how best to utilise the alternative bDMARDs following an initial TNFi-inadequate response. Although large observational studies have been performed, the need for more direct comparisons to provide sufficiently robust evidence to inform clinicians is necessary. Results from recent trials are emerging. Nevertheless, data suggesting that subgroups are more responsive to a particular targeted therapy (seronegativity and TNFi<sup>99</sup>) highlight the importance of including such factors in study design to avoid prematurely discounting alternative TNFi drug as an effective therapeutic option, particularly in the context of resistant and aggressive disease cohorts. In addition, optimal bDMARD choice based on the nature of prior inefficacy (primary or secondary) has not been addressed to date. Despite several treatment options now available, no large-scale head-to-head comparisons investigating the efficacy of sequential biologic treatments have been conducted to date.

The SWITCH trial<sup>100</sup> was a well-designed randomised trial in this therapeutic area, which also aimed to explore the more refined clinical questions that would thus provide clear guidance to clinicians. This study aimed to evaluate whether or not alternative class bDMARDs compared with rituximab (the NICE-preferred second-line option) were comparable in efficacy and safety outcomes. The results of this study were expected to contribute to the development of a rational treatment algorithm and more judicious and cost-effective management, in particular to allow individualised treatment regimens rather than switching all patients to a single (and potentially unsuccessful and toxic) therapy. The trial was stopped early by the funding committee because of unforeseen interruptions and lengthy site set-up, which, thus, impacted on the inability to recruit to target on time. Although the results presented in this report are not sufficiently powerful to address these aims, we expect that the controlled data will inform the emerging evidence base and can be included in meta-analyses.

## Chapter 2 Clinical trial methods

### Objectives

In patients with RA who had failed treatment to an initial TNFi (according to NICE guidance), the objectives of this study were as follows.

#### Primary objective

The primary objective was to determine whether or not an alternative-mechanism TNFi or abatacept is non-inferior to rituximab in disease response at 24 weeks post randomisation.

#### Secondary objectives

The secondary objectives were:

- to compare alternative TNFis and abatacept with rituximab for disease response, quality of life, toxicity and safety over 48 weeks
- to undertake an evaluation of the cost-effectiveness of switching patients to alternative TNFi, abatacept or rituximab
- to compare structural and bone density outcomes for abatacept and alternative TNFis with those for rituximab over 48 weeks using plain radiography and bone densitometry score.

#### Exploratory objectives

The exploratory objectives were:

- to determine the optimal sequence of treatments by assessing whether or not the response to the second treatment in patients with RA is affected by which initial TNFi the patients failed treatment on (TNFi monoclonal or TNFi receptor fusion protein)
- to evaluate whether or not the response to the second treatment (alternative TNFi, abatacept or rituximab) is affected by whether or not the patient was a primary (no initial response) or secondary (loss of an initial response) response failure to their initial TNFi therapy
- to ascertain whether or not seropositive (to either or both of RF and ACPA) and seronegative patients with RA behave differently in their response and disease outcome measures across the three treatment arms, particularly with respect to rituximab.

### Design

The study was a multicentre, Phase III, open-label, non-inferiority, parallel-group, three-arm RCT comparing the clinical effectiveness and cost-effectiveness of alternative TNFi and abatacept (separately) with that of rituximab in patients with RA who have failed an initial TNFi treatment.

Patients were randomised on a 1 : 1 : 1 basis to receive one of the following:

1. alternative TNFi:
  - i. etanercept if patient had initial failure of a monoclonal antibody: infliximab, adalimumab, certolizumab or golimumab

OR

- ii. monoclonal antibody: infliximab, adalimumab, certolizumab or golimumab if patient had initial failure of etanercept (choice of monoclonal TNFi at investigator's discretion)
- 2. abatacept
- 3. rituximab.

Patients received randomised treatment during the interventional phase to a maximum of 48 weeks and were subsequently followed up to a maximum of 96 weeks in the observational phase.

The study was reviewed and approved by the National Research Ethics Service, Research Ethics Committee Leeds (West) (reference number 11/H1307/6) and was registered as an International Standard Randomised Controlled Trial number 89222125 and with ClinicalTrials.gov identifier NCT01295151. The trial protocol<sup>100</sup> can be accessed at <http://bmc-musculoskeletal-disorders.biomedcentral.com/articles/10.1186/1471-2474-15-452>.

## Patient and public involvement

Ailsa Bosworth, Chief Executive and Founder of the National Rheumatoid Arthritis Society, was the patient and public involvement (PPI) member on the Trial Management Group and provided valuable PPI input to the development of the SWITCH trial proposal and on key decisions throughout the trial.

There was also involvement from a PPI representative on the Trial Steering Committee, Sandra Purdy, who provided input into the patient information sheet and other trial documentation intended for use by patients. Through membership of the Trial Steering Committee, the PPI representative also provided input into the design and conduct of the trial through annual meetings.

## Participants

Patients attending hospital-based rheumatology outpatient departments throughout the UK, who had been diagnosed with RA, were receiving MTX, had not responded to (at least two) csDMARD therapy (including MTX) and had experienced an inadequate response to treatment with one TNFi were invited to be screened for eligibility in the trial if they:

- were male or female and aged  $\geq 18$  years
- had a diagnosis of RA as per the ACR/EULAR 2010 classification criteria confirmed at least 24 weeks prior to the screening visit
- failed csDMARD therapy according to NICE/BSR guidelines,<sup>101</sup> that is failure of at least two csDMARDs including MTX
- had persistent RA disease activity despite having been treated with a current initial TNFi agent for at least 12 weeks. Active RA was defined as:
  - primary non-response defined as failing to improve DAS28 by  $> 1.2$  units or failing to achieve a DAS28 of  $\leq 3.2$  units within the first 12–24 weeks of starting the initial TNFi treatment (this may include patients who have shown a reduction in DAS28 of  $> 1.2$  units but still demonstrate an unacceptably high disease activity in the physician's judgement with evidence of an overall DAS28 of  $\geq 3.2$  units)

OR

- secondary non-response defined as lack of efficacy of the first TNFi treatment (having demonstrated prior satisfactory response) as per clinician judgement, with the reason for cessation of the first TNFi treatment other than intolerance



- were MTX dose stable for 4 weeks prior to the screening visit and to be continued for the duration of the study
- were on non-steroidal anti-inflammatory drugs (NSAIDs) and/or corticosteroids (oral prednisolone not exceeding 10 mg daily), on an unchanged regimen for at least 4 weeks prior to the screening visit and were expected to remain on a stable dose until the baseline assessments have been completed
- provided written informed consent prior to any trial-specific procedures.

Patients were excluded if they met any one of the following criteria.

- They had had major surgery (including joint surgery) within 8 weeks prior to the screening visit or planned major surgery within 52 weeks following randomisation.
- They had inflammatory joint disease of different origin, mixed connective tissue disease, Reiter's syndrome, psoriatic arthritis, systemic lupus erythematosus, or any arthritis with onset prior to 16 years of age.
- They had received doses of prednisolone of > 10 mg/day within the 4 weeks prior to the screening visit.
- They had received intra-articular or intramuscular steroid injections within 4 weeks prior to the screening visit.
- They had previously received more than one TNFi drug OR any other bDMARD for the treatment of RA.
- They were unable or unwilling to stop treatment with a prohibited DMARD (i.e. synthetic DMARD aside from MTX, e.g. oral or injectable gold, chloroquine, hydroxychloroquine, ciclosporin, azathioprine, leflunomide, sulfasalazine) prior to the start of protocol treatment.
- They had been treated with any investigational drug in the last 12 weeks prior to the start of protocol treatment.
- They had other comorbidities including acute, severe infections, uncontrolled diabetes, uncontrolled hypertension, unstable ischaemic heart disease, moderate/severe heart failure (class III/IV of the New York Heart Association functional classification system<sup>102</sup>), active bowel disease, active peptic ulcer disease, recent stroke (within 12 weeks before the screening visit), or any other condition which, in the opinion of the investigator, would put them at risk if they participated in the study or would make implementation of the protocol difficult.
- They had experienced any major episode of infection requiring hospitalisation or treatment with intravenous antibiotics within 12 weeks of start of the treatment protocol or oral antibiotics within 4 weeks of start of the protocol treatment.
- They were at significant risk of infection that, in the opinion of the investigator, would put them at risk if they participated in the study [e.g. leg ulceration, indwelling urinary catheter, septic joint within 52 weeks (or ever if a prosthetic joint is still in situ)].
- They had known active current or a history of recurrent bacterial, viral, fungal, mycobacterial or other infections including herpes zoster [for tuberculosis (TB) and hepatitis B and C, see below], but excluding fungal infections of nail beds as per clinical judgement.
- They had untreated active current or latent TB. Patients should have been screened for latent TB (as per BSR's guidelines) within 24 weeks prior to the screening visit and, if positive, treated following local practice guidelines prior to the start of protocol treatment.
- They had active current hepatitis B and/or C infection. Patients should have been screened for hepatitis B and C within 24 weeks prior to the screening visit and, if positive, excluded from the study.
- They had primary or secondary immunodeficiency (history of or currently active) unless related to primary disease under investigation.
- In the case of women, they were pregnant or lactating or were women of child-bearing potential (WCBP) who were unwilling to use an effective birth control measure while receiving treatment and after the last dose of protocol treatment, as indicated in the relevant summary of product characteristics (SmPC) or investigator's brochure (IB).
- In the case of men, their partners were WCPB who were unwilling to use an effective birth control measure while receiving treatment and after the last dose of protocol treatment as indicated in the relevant SmPC/IB.

- They were known to have significantly impaired bone marrow function as a result of, for example, significant anaemia, leucopenia, neutropenia or thrombocytopenia, defined by the following laboratory values at the time of the screening visit:
  - haemoglobin level of  $< 8.5$  g/dl
  - platelet count of  $< 100 \times 10^9/l$
  - white blood cell count of  $< 2.0 \times 10^9/l$
  - neutrophil count of  $< 1 \times 10^9/l$
- They were known to have severe hypoproteinaemia at the time of the screening visit as a result of, for example, nephrotic syndrome or impaired renal function, defined by:
  - a serum creatinine concentration of  $> 150$   $\mu\text{mol/l}$ .

The eligibility criteria were based on BSR's guidelines on the use of TNFi.<sup>101</sup> Important exclusion criteria that are adhered to in clinical practice were applied in this study.

### Recruitment

Patients were approached during standard clinic visits for the management of their RA, or were identified by waiting lists, registries or reviews of case records, and sent a personalised letter inviting them to participate. Patients were provided with verbal and written details about the trial and had as long as they required to consider participation. Assenting patients provided written consent before being registered into the trial and formally assessed for eligibility. Patients at Chapel Allerton Hospital also had the option of giving informed consent for blood and tissue samples to be taken for the SWITCH trial biobank for future scientific research. The participant information sheet and consent forms are provided in *Appendix 1*.

## Interventions

### Abatacept

Abatacept is a selective T-cell co-stimulation blocking agent that is a fusion protein composed of the Fc region of the immunoglobulin G1 (IgG1) fused to the extracellular domain of cytotoxic T-lymphocyte-associated protein 4 (CTLA-4).

### Alternative tumour necrosis factor inhibitors

#### Etanercept

Etanercept is a human TNF receptor p75Fc fusion protein produced by recombinant deoxyribonucleic acid (rDNA) technology. Patients randomised to receive alternative TNFis whose initial TNFi was a monoclonal antibody received etanercept as their intervention.

#### Monoclonal antibodies

For patients randomised to receive alternative TNFi whose initial TNFi was etanercept, the allocation was to one of four anti-TNF monoclonal antibodies. Within this group of interventions, allocation was at the discretion of the treating clinician.

- Adalimumab: a recombinant fully human IgG1 monoclonal antibody specific for TNF produced in a mammalian cell expression system.
- CZP: a recombinant (Fc-free) humanised antibody Fab fragment against TNF and conjugated to polyethylene glycol.
- Infliximab: a chimeric (human–murine) IgG1 monoclonal antibody produced by rDNA technology.
- Golimumab: a fully human IgG1 monoclonal antibody to TNF.

### Rituximab (control)

A genetically engineered chimeric (human–murine) monoclonal antibody against the B-cell protein marker CD20 (clusters of differentiation 20).

Efficacy of rituximab to placebo was established in a similar patient population in the REFLEX study.<sup>49</sup>

Table 1 illustrates the treatment regimen including mode of administration and dose, for each of the three treatment arms. The intervention period was 48 weeks, achieved via treatment regimens administered for a minimum of 24 weeks.

## Study procedures

### Screening and baseline assessments

Following written informed consent and prior to any trial-related procedures, patients were registered into the study. All patients had a screening assessment within 4 weeks prior to the baseline assessment (and, when applicable, the assessment was repeated at the baseline assessment) to establish eligibility. The clinical assessment included a medical history, a physical examination, which included measurements of height, weight and vital signs, electrocardiography (ECG), chest radiography and a screen for TB (if not performed within specified time window prior to the screening visit). In addition, a 28 swollen joint count (SJC) and tender joint count (TJC) were performed (Figure 1), and blood and urine tests [haematology, blood chemistry, C-reactive protein (CRP) level test, erythrocyte sedimentation rate (ESR), serological tests, hepatitis B and C screen, a pregnancy test and urinalysis] were undertaken. At the baseline assessment, a further blood test was undertaken to assess glucose levels and lipid profiles.

**TABLE 1** Trial treatment regimen by treatment arm

Treatment arm	Treatment description
Rituximab	A single dose of 1 g as an intravenous infusion administered at days 0 (week 0) and 15 (week 2). In line with standard practice, a patient who lost an initial 6-month (week 24) response, as per NICE's guidance, could receive a further cycle of rituximab after a minimum of 6 months following the first dose. The second cycle of rituximab was, again, given at a dose of 1 g; two intravenous infusions administered at a 2-week interval, for example week 24 and 26. Prior to receiving rituximab, 100 mg of intravenous methylprednisolone was given as a premedication
Abatacept	Solution for subcutaneous injection: 125 mg per syringe (125 mg/ml). Administered at a dose of 125 mg at week 0 and once weekly thereafter for a minimum of 24 weeks
Alternative TNFi	
Etanercept	A single dose of 50 mg by subcutaneous injection weekly for a minimum of 24 weeks (unless not tolerated)
Adalimumab	A single dose of 40 mg by subcutaneous injection every 2 weeks for a minimum of 24 weeks (unless not tolerated)
Infliximab	A dose of 3 mg/kg per intravenous infusion, administered on a day-case unit or equivalent at weeks 0, 2 and 6 and then every 8 weeks thereafter for a minimum of 24 weeks
CZP	Single dose of 400 mg by subcutaneous injection at weeks 0, 2 and 4 and then at a dose of 200 mg every 2 weeks thereafter for a minimum of 24 weeks
Golimumab	Dose of 50 mg by subcutaneous injection every 4 weeks for a minimum of 24 weeks. Available as IMP within the SWITCH trial following approval in November 2013

IMP, investigational medicinal product.

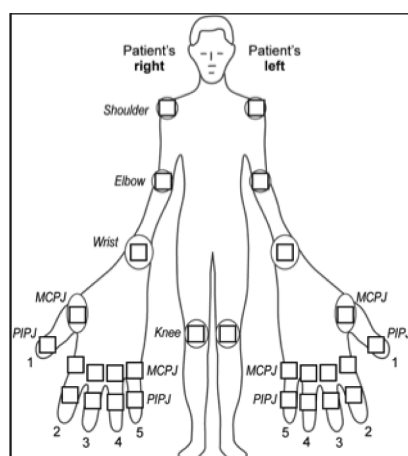

**FIGURE 1** Manikin showing joints to be included in the SJ and TJC. MCPJ, metacarpophalangeal joint; PIPJ, proximal interphalangeal joint.

At screening and baseline assessments, patients completed a Global Assessment of Arthritis using a visual analogue scale (VAS) and reported the extent of their early-morning stiffness. The clinician assessed the Global Disease Activity using a VAS. At the baseline assessment, patients completed a Global Assessment of Pain VAS and an assessment of their general health using a VAS.

### **Intervention and observational phase assessments**

Randomised patients attended clinic assessment visits at weeks 12, 24, 36 and 48 in the interventional phase and at weeks 60, 72, 84 and 96 in the observational phase. Patients allocated to the subcutaneous TNFi or abatacept therapies had additional standard assessment for safety purposes (usually week 4) in line with local practice. At the Leeds Chapel Allerton Hospital site, biological samples from patients consenting to the SWITCH trial biobank substudy were collected prior to commencement of the trial treatment and at weeks 2, 4, 12, 24 and 48 or at the time of early discontinuation, and stored for future research. See *Appendix 5, Tables 33–35*, for the schedule of events for rituximab, infliximab and subcutaneous bDMARDs.

## **Outcome measures**

### **Primary outcome measure**

The primary outcome measure was the absolute reduction from baseline in DAS28 at 24 weeks post randomisation. DAS28 is a measure of disease activity in RA.<sup>103,104</sup> The composite score is calculated as a function of the number of tender and swollen joints (total 28 joints), the ESR and the patient's global assessment of their arthritis measured using a VAS (see *Appendix 6, Box 1*).

### **Secondary outcome measures**

The following outcomes were measured over 48 weeks (at each of the visit time points).

### **Clinical measures**

- DAS28.
- Reduction in DAS28 of  $\geq 1.2$  units.
- Low disease activity rate and remission rate: low disease activity is defined as  $2.6 < \text{DAS28} \leq 3.2$  units and remission as DAS28 of  $\leq 2.6$  units (see *Appendix 6, Table 36*).
- EULAR response scores: EULAR response criteria are applied to the DAS28 and classify patients as good, moderate or non-responders using the DAS28 and the absolute reduction in the DAS28 from baseline (see *Appendix 6, Table 37*).

- ACR20, ACR50 and ACR70:<sup>105</sup> composite measures developed for RA. These are defined as a relative improvement (reduction) from baseline of at least 20% (or 50% or 70% for ACR50 and ACR70, respectively) in TJC and SJC and a relative 20% (or 50% or 70% for ACR50 and ACR70, respectively) improvement in three out of the five following criteria:
  - Patient Global Assessment of Arthritis (VAS)
  - Physician Global Assessment of Disease Activity (VAS)
  - Patient Global Assessment of Pain (VAS)
  - Patient assessment of physical function as measured by the Health Assessment Questionnaire Disability Index (HAQ-DI) questionnaire
  - Results of laboratory test for inflammatory markers (either ESR or CRP level).
- CDAI:<sup>104,106</sup> a composite outcome measure consisting of the number of tender joints (i.e. 28-joint count), the number of swollen joints (i.e. 28-joint count), a patient global assessment of disease activity (measured via a 100-mm VAS) and Physician Global Assessment of Disease Activity (measured via a 100-mm VAS). *Appendix 6, Table 38*, provides the response categories for CDAI.
- Simplified Disease Activity Index (SDAI):<sup>104,107</sup> a composite outcome measure consisting of the number of tender joints (28-joint count), the number of swollen joints (28-joint count), the Patient Global Assessment of Disease Activity (measured via a 100-mm VAS), the Physician Global Assessment of Disease Activity (measured via a 100-mm VAS) and CRP level (mg/dl). *Appendix 6, Table 39* provides the response categories for SDAI.
- In-remission rates according to the ACR/EULAR Boolean criteria: this is defined as SJC, TJC, patient global assessment and CRP level scores all  $\leq 1$ .<sup>108</sup>

The use of 28-joint count-based outcome measures is well accepted and established in RA trials. This is based on prior evaluation of the performance between 28- and 66-joint count assessments.<sup>109–111</sup> However, we acknowledge on an individual patient level, RA activity outside the 28 joints may be missed and thus influence individual disease activity and response assessments.

## Quality of life

- The Health Assessment Questionnaire Disability Index<sup>112</sup> includes 20 questions across eight domains relating to physical function and the need for any help or aids to undertake daily activities. The extent of disability is scored on a scale from 0 (no disability) to 3 (severe disability) for each item relating to rising, dressing, walking and other activities; patients are then asked to list any aids or devices required to undertake such activities. The use of help or aids increases the category score from 0 or 1 to 2 if it has been indicated that aids/help are required in that category. If the category score is already a 2 or 3, no adjustment is made. The total score is derived by taking the maximum score across all domains (0–24) and dividing by 8 to provide an average score (0–3), with higher scores representing greater disability.
- The Hospital Anxiety and Depression Scale (HADS)<sup>113</sup> describes the degree to which patients feel anxious and/or depressed. It comprises 14 questions for each symptom, and each question has four possible responses, ranging from 0, representing no anxiety/depression, to 3, representing high anxiety/depression. Responses are totalled to provide two scales, one for each domain, with a measurement range from 0 to 21.
- The Rheumatoid Arthritis Quality of Life (RAQoL)<sup>114</sup> questionnaire is a specific disease activity measure for RA. It is a 30-item questionnaire, the response to each item being yes (score as 1) or no (score as 0), that ascertains the extent of RA symptoms experienced. The maximum RAQoL score is 30.

## Safety

Toxicity is defined as any symptom or event requiring permanent cessation of treatment.

## Imaging

Plain radiographs of hands and feet were requested (for later scoring to calculate the modified Genant score) and bone densitometry scans for T-scores of unilateral neck of femur and lumbar spine were obtained at baseline and week 48 in a subgroup of patients recruited at centres with the facilities to do the imaging. Note that the plain radiographs were not scored because of the inability to secure additional resource centrally to conduct the analysis (compounded by the early termination/underpowered study).

## Safety monitoring

Adverse events (AEs) and adverse reactions (ARs) were monitored throughout the trial and recorded at each treatment visit. An AE was defined as any untoward medical occurrence in a trial patient that does not necessarily have a causal relationship with the treatment. An AR was defined as any untoward and unexpected responses to an investigational medicinal product (IMP) related to any dose administered.

A serious adverse event (SAE) or a suspected serious adverse reaction (SSAR) was defined as any untoward medical occurrence or effect that resulted in death, persistent or significant disability or incapacity or a congenital anomaly or birth defect, or was life-threatening, or required inpatient hospitalisation or prolongation of existing hospitalisation or may have jeopardised the patient necessitating medical or surgical intervention to prevent one of the outcomes stated in *Outcome measures*.

Expected common SAEs related to RA were the development of major extra-articular manifestations of disease, for example vasculitis, and blood dyscrasia associated with disease activity. Expected serious ARs common to all treatments were allergic reactions, injection site/infusion reaction, blood dyscrasias, serious infections, diarrhoea, new infections, toxic epidermal necrolysis, Stevens–Johnson syndrome or severe rash, pulmonary fibrosis, renal failure, neurological impairment, new autoimmunity and cardiovascular abnormalities.

All SAEs, regardless of the suspected relationship to the trial treatment, were reported to the Clinical Trials Research Unit within 24 hours of the research staff becoming aware of the event. SAEs were followed up until the event had resolved or a trial outcome had been reached. All AEs/ARs and SAEs were monitored from randomisation until a maximum of 30 days (later revised to 32 days) after the last dose of randomised treatment during the interventional phase (week 48 maximum). Beyond this, only SAEs considered to be related to the randomised treatment administered during the interventional phase were reported.

## Patient withdrawal

Patients could withdraw from the trial at any time without explanation, and continue to receive treatment as per standard clinical practice. Patient withdrawal was categorised as withdrawal of consent for: further trial treatment only, further trial treatment and visits but willing to have follow-up data collected or further trial treatment and follow-up information.

## Sample size and power calculation

A total of 429 evaluable patients were required to have 80% power to demonstrate non-inferiority of either abatacept or alternative TNFi to rituximab at the 5% significance level. A total of 143 evaluable patients in each treatment group provided 80% power for the lower limit of the two-sided 95% confidence interval (CI) for the true difference in the reduction in the DAS28 (abatacept/alternative TNFi – rituximab) to lay above –0.6 units, assuming no difference between treatment groups and a standard deviation (SD) between patients of 1.8 units (the REFLEX study<sup>49</sup>). Allowing for a loss to follow-up of 10%, a total of 477 patients

were to be recruited. No adjustment for multiplicity of the comparisons of each treatment group to rituximab was made.<sup>115,116</sup>

The proposed non-inferiority margin of  $-0.6$  units in the reduction in the DAS28 at 24 weeks post randomisation corresponds to the maximum difference in a reduction in the DAS28 that is considered to be of no clinical relevance and is the threshold for the clinical distinction of 'inferiority' (corresponds to the maximum change in the DAS28 within patients with a low or moderate disease activity that is classified as 'no response' by the EULAR criteria). A DAS28 of 0.6 units is also the reported measurement error.<sup>117</sup>

For the analysis of the secondary outcome measures to compare quality of life, toxicity and safety at 24 weeks between treatment arms the sample size of 143 evaluable patients per group would detect a standardised effect size of 0.33 (small to medium by the definition of Cohen<sup>118</sup>), with 80% power and two-sided 5% significance level.

After opening, the trial underwent a major redesign. The original target sample size was 870, based on 80% power to determine whether or not abatacept or alternative TNFi are non-inferior to rituximab at 24 weeks post randomisation in the proportion of patients achieving a DAS28 reduction of  $\geq 1.2$  units without toxicity. The corresponding non-inferiority margin was set at 12% (as an absolute difference) and assumed a response rate of 65% in the rituximab arm. The original trial design was also powered for a definitive subgroup analysis to determine if there was a differential treatment response between seropositive and seronegative patients. Owing to the challenges in trial setup and associated poor initial patient recruitment, and reassessment of important end points, the primary outcome measure was changed from a binary to a continuous outcome that (following consensus discussion with the principal investigators) was still considered clinically relevant. This allowed a reduction in sample size to 477 patients while still ensuring a trial of clinical relevance. The previous planned definitive subgroup analysis was relegated to an exploratory analysis. The trial redesign was unanimously supported by the Data Monitoring and Ethics Committee and the Trial Steering Committee, was approved by the funder and received ethics approval.

## Randomisation

Randomisation took place once eligibility was confirmed and baseline assessments and questionnaires were complete. Patients were randomised in a 1 : 1 : 1 allocation ratio to receive alternative TNFi, abatacept or rituximab. Treatment group allocation used a computer-generated minimisation program incorporating a random element of 0.8, to ensure that treatment groups were well balanced for the following minimisation factors: centre, disease duration ( $< 5$  years or  $\geq 5$  years), non-response (primary or secondary) and RF/ACPA status (either of RF or ACPA positive, or both RF and ACPA negative).

Both registration and randomisation were performed centrally using an automated 24-hour telephone system based at the Clinical Trials Research Unit. Centres completed a log of all patients aged  $> 18$  years with RA whose treatment had failed for an initial TNFi agent and were considered for the trial but who were not registered for screening or randomised, either because of ineligibility or because of refusal to participate.

## Blinding

Blinding of patients and the treating clinicians to treatment allocation was not possible in the trial because of the nature and mode of administration of the different treatment regimens.

## Analysis

Formal analyses were conducted using a two-sided 5% level of significance, with exception of the primary analysis, which used a one-sided 2.5% level of significance. All analyses were performed using SAS version 9.4 (SAS Institute Inc., Cary, NC, USA). The statistical analysis plan is provided in *Appendix 7*.

The trial planned for one interim analysis to allow for early stopping of either abatacept or alternative TNFi if inferiority compared with rituximab was demonstrated. This analysis would have taken place once 50% of patients (i.e. 239) had reached 24 weeks of follow-up. Following the early termination of the trial, there was no basis for an interim analysis.

### Patient populations

All patients recruited into the trial were included in the analysis using 'intention to treat' (ITT) and analysed according to the randomised allocation.

A per protocol (PP) population analysis was also undertaken; patients who deviated from the protocol or failed to comply with the required treatment regimen were excluded (see *Appendix 7* for further details of exclusions). For the analysis of the primary outcome measure, non-inferiority needed to be demonstrated in both the ITT and PP populations in order to infer non-inferiority.

The complete-case population included all patients with complete data for the relevant outcome measure summarised.

The safety population included all patients who received at least one dose of treatment and is summarised by treatment received.

### Missing data

Multiple imputation by chained equations was used to impute missing values at the component level for the DAS28 and ACR20,<sup>119</sup> under the assumption that the data were 'missing at random'. The minimisation factors of disease duration, RF/ACPA status and non-response category and the values of the component end points at all visits from baseline to week 48 (for DAS28 components) and to week 24 (for ACR components) were included in the imputation models. Centre was not included because of the small number of patients recruited in each centre.

Imputations were performed separately for each of the three treatment groups; 27 imputed data sets were created for each treatment group for the primary end point DAS28 and 22 for the secondary end-point ACR20, corresponding to the maximum percentage of missing data across all end points and time points. Predictive mean matching was used to select a value to impute from the three observed values closest to the fitted value in each imputation.<sup>120</sup> The composite end points were then derived in each of the fully imputed data sets (see *Appendix 7* for further detail).

### Primary outcome measure

A mixed-effects linear regression model was fitted to the primary end point, absolute reduction in the DAS28 at 24 weeks, with covariates corresponding to the minimisation factors and treatment group; centre was fitted as a random effect.

Algebraic representation for the mixed-effects linear regression model is:

$$\text{DAS28}_i = \alpha_1 + \alpha_2 \text{disease duration} + \alpha_3 \text{RF\&ACPA status} + \alpha_4 \text{non-responder status} + \alpha_5 \text{treat}_{\text{AITNFI}} + \alpha_6 \text{treat}_{\text{ABAT}} + (\alpha_7 + \alpha_{7i}) \text{centre} + \varepsilon_i \quad (1)$$

Parameter estimates from the mixed-effects models across each of the fully imputed data sets were combined using Rubin's rules.<sup>119,121</sup> Estimates of each treatment effect and corresponding 95% CIs and *p*-values were reported in relation to the predefined non-inferiority margin of -0.6 units on the reduction in the DAS28 at 24 weeks post randomisation.

The primary analysis model was fitted to the ITT, PP and complete-case populations. Non-inferiority in both the ITT and PP patient populations was required in order to conclude non-inferiority. A sensitivity analysis



was completed on the ITT population with an additional covariate, baseline DAS28, fitted to the primary analysis model.

### Key secondary outcome measures

#### Disease Activity Score of 28-joint scores over 48 weeks

Initially a random coefficient linear regression model was fitted to the DAS28 over time, with covariates entered for the minimisation factors, baseline DAS28, treatment group, time and time-by-treatment interaction; centre, patient and patient-by-time interaction random effects were fitted. However, as there was evidence of non-constant residual error variance, a multivariable covariance pattern model was fitted to the scores over time (at weeks 12, 24, 36 and 48), with the same covariates entered for the minimisation factors (excluding centre), baseline DAS28, treatment group, time and time-by-treatment interaction, and an unstructured covariance pattern was specified. Centre was not fitted as a random effect, as there was no centre component of variation in 24 of the 27 imputed data sets.

Algebraic representation for the random coefficient linear regression model is:

$$\begin{aligned} \text{DAS28}_{ij} = & (\alpha_1 + \alpha_{1i}) + (\alpha_2 + \alpha_{2i})\text{time} + (\alpha_3 + \alpha_{3i})\text{centre} + \alpha_4\text{baseline DAS28} + \alpha_5\text{disease duration} \\ & + \alpha_6\text{RF\&ACPA status} + \alpha_7\text{non-responder status} + \alpha_8\text{treat}_{\text{AItTNFi}} + \alpha_9\text{treat}_{\text{ABAT}} \\ & + \alpha_{10}(\text{time}_j \times \text{treat}_{\text{AItTNFi}}) + \alpha_{11}(\text{time}_j \times \text{treat}_{\text{ABAT}}) + \varepsilon_{ij}. \end{aligned} \quad (2)$$

Algebraic representation for the covariance pattern model is:

$$\begin{aligned} \text{DAS28}_{ij} = & \alpha_1 + \alpha_2\text{BaselineDAS28} + \alpha_3\text{disease duration} + \alpha_4\text{RF\&ACPA status} \\ & + \alpha_5\text{non-responder status} + \alpha_6\text{treat}_{\text{AItTNFi}} + \alpha_7\text{treat}_{\text{ABAT}} + \alpha_8\text{visit}_{j=\text{Week 24}} \\ & + \alpha_9\text{visit}_{j=\text{Week 36}} + \alpha_{10}\text{visit}_{j=\text{Week 48}} + \alpha_{11}(\text{treat}_{\text{AItTNFi}} \times \text{visit}_{j=\text{Week 24}}) \\ & + \alpha_{12}(\text{treat}_{\text{ABAT}} \times \text{visit}_{j=\text{Week 24}}) + \alpha_{13}(\text{treat}_{\text{AItTNFi}} \times \text{visit}_{j=\text{Week 36}}) \\ & + \alpha_{14}(\text{treat}_{\text{ABAT}} \times \text{visit}_{j=\text{Week 36}}) + \alpha_{15}(\text{treat}_{\text{AItTNFi}} \times \text{visit}_{j=\text{Week 48}}) \\ & + \alpha_{16}(\text{treat}_{\text{ABAT}} \times \text{visit}_{j=\text{Week 48}}) + \varepsilon_{ij}; \text{corr}(\varepsilon_{i, j=m}, \varepsilon_{i, j=n}) = \rho_{mn} \text{ for } m \neq n, \end{aligned} \quad (3)$$

where  $m$  and  $n$  denote two (arbitrary) different visit time points.

#### Disease Activity Score of 28 joints response over 48 weeks (reduction in Disease Activity Score of 28 joints of $\geq 1.2$ )

A multivariable covariance pattern logistic model was fitted to the response variable, achieving a reduction in the DAS28 of  $\geq 1.2$  units over time (at weeks 12, 24, 36 and 48), with covariates entered for the minimisation factors (excluding centre), baseline DAS28, treatment group, time and time-by-treatment interaction. An unstructured covariance pattern was specified. Centre was not fitted as a random effect because the model failed to converge.

$$\begin{aligned} \text{logit}[\text{pr}(\text{Reduction in DAS28}_{ij} \geq 1.2 \text{ since baseline})] = & \alpha_1 + \alpha_2\text{BaselineDAS28} \\ & + \alpha_3\text{disease duration} + \alpha_4\text{RF\&ACPA status} + \alpha_5\text{non-responder status} \\ & + \alpha_6\text{treat}_{\text{AItTNFi}} + \alpha_7\text{treat}_{\text{ABAT}} + \alpha_8\text{visit}_{j=\text{Week 24}} + \alpha_9\text{visit}_{j=\text{Week 36}} + \alpha_{10}\text{visit}_{j=\text{Week 48}} \\ & + \alpha_{11}(\text{treat}_{\text{AItTNFi}} \times \text{visit}_{j=\text{Week 24}}) + \alpha_{12}(\text{treat}_{\text{ABAT}} \times \text{visit}_{j=\text{Week 24}}) + \alpha_{13}(\text{treat}_{\text{AItTNFi}} \times \text{visit}_{j=\text{Week 36}}) \\ & + \alpha_{14}(\text{treat}_{\text{ABAT}} \times \text{visit}_{j=\text{Week 36}}) + \alpha_{15}(\text{treat}_{\text{AItTNFi}} \times \text{visit}_{j=\text{Week 48}}) + \alpha_{16}(\text{treat}_{\text{ABAT}} \times \text{visit}_{j=\text{Week 48}}) \\ & + \varepsilon_{ij}; \text{corr}(\varepsilon_{i, j=m}, \varepsilon_{i, j=n}) = \rho_{mn} \text{ for } m \neq n, \end{aligned} \quad (4)$$

where  $m$  and  $n$  denote two (arbitrary) different visit time points.

### American College of Rheumatology 20 at week 24

A multivariable logistic regression model was fitted to ACR20 at 24 weeks post randomisation, with covariates entered for the minimisation factors (excluding centre) and treatment group. Centre was not fitted as a random effect, as there was no centre component of variation.

Algebraic representation of the analysis model:

$$\begin{aligned} \text{logit}[\text{pr}(\text{ACR20 response at week 24})] = & \alpha_1 + \alpha_2 \text{disease duration} + \alpha_3 \text{RF\&ACPA status} \\ & + \alpha_4 \text{non-responder status} + \alpha_5 \text{treat}_{\text{AITNFI}} + \alpha_6 \text{treat}_{\text{ABAT}} + \varepsilon_{ij}. \end{aligned} \quad (5)$$

In all analyses estimation of the treatment effects was of primary interest, but hypothesis testing was also performed. Treatment group effects were tested and the significance level is presented based on the Wald test (because of limitations of the likelihood ratio test for imputed data sets<sup>119</sup>). Model fit was assessed informally by examination of standardised residuals.

### *Additional secondary outcome measures*

All additional secondary outcome measures, including further measures of disease activity and quality of life were summarised by treatment group and compared informally using descriptive statistics. The predefined subgroup analyses to evaluate the treatment modification effect of RF/ACPA status, initial TNFi group failed on and non-response category on the DAS28 were summarised by treatment group. In addition, treatment compliance, toxicity and safety were summarised.

### Summary of protocol amendments

*Appendix 8* provides a summary of the key protocol amendments throughout the trial.

## Chapter 3 Clinical trial results

### Patient recruitment

Between July 2012 and December 2014, 678 patients were screened for the trial across 35 centres. A total of 529 patients were excluded at screening (pre-registration), 417 of whom failed to meet the eligibility criteria. The main reasons for failing to meet the eligibility criteria were that they had not failed an initial TNFi agent ( $n = 95$ ), were not on a stable dose of MTX over the previous 28 days ( $n = 92$ ) and had received more than one TNFi drug or other biological agent ( $n = 72$ ). A total of 149 patients gave written informed consent and were registered onto the trial.

Twenty-seven patients were excluded post registration, of whom 19 did not meet the eligibility criteria, two withdrew consent and six were excluded for other reasons (rescreening required, previous hepatitis infection, raised alkaline phosphatase levels, awaiting cancer diagnosis/treatment, patient not contactable, unknown reason). The remaining 122 patients were randomised to treatment. Following early trial termination because of the withdrawal of funding, the last patient was randomised on 18 December 2014.

A summary of the number of patients considered, registered and randomised by centre is provided in *Appendix 9, Table 40*. The flow of patients from initial assessment through to the end of follow-up is shown in *Figure 2* (Consolidated Standards of Reporting Trials diagram). Full reasons for ineligibility and non-consent are provided in *Appendix 9, Tables 41–43*.

### Recruitment target

*Figure 3* displays the projected recruitment against the actual recruitment across all centres during the trial recruitment period. Although the target for recruitment of 16 centres was reached by September 2013, the number of eligible patients identified by centres was much lower than expected (see *Appendix 9, Table 40*). Barriers to reaching the target included a 9-month halt to recruitment because of unforeseen contractual issues with a home health-care company, longer times for centre set-up, primarily because of the commissioning environment with significant geographical variability in receptiveness of Clinical Commissioning Groups (CCGs) to approve RCTs that included non-NICE-approved therapies and delays to approval.

Although the patient recruitment rate improved as new centres were initiated, overturning the deficit accrued from the above delays was not feasible within the planned recruitment period. Based on the number of centres opened and observed recruitment rates, recruitment to November 2017 would have been required to reach the target of 477 patients, at an additional cost of £450,000. Consequently, the Health Technology Assessment (HTA) programme monitoring panel withdrew funding in November 2014; the trial closed to recruitment in December 2014.

The study closure patient information sheet and article for the National Rheumatoid Arthritis Society web page (and other relevant electronic forums) are in *Appendices 3* and *4*, respectively.

### Randomisation

The overall mean randomisation rate was 0.26 patients per month, that is, 3.12 patients per centre per year, across 35 centres. Twenty-eight centres randomised at least one patient and only seven centres randomised more than five patients, with the co-ordinating hospital (Chapel Allerton) providing 32 (26%) of all the randomised patients.

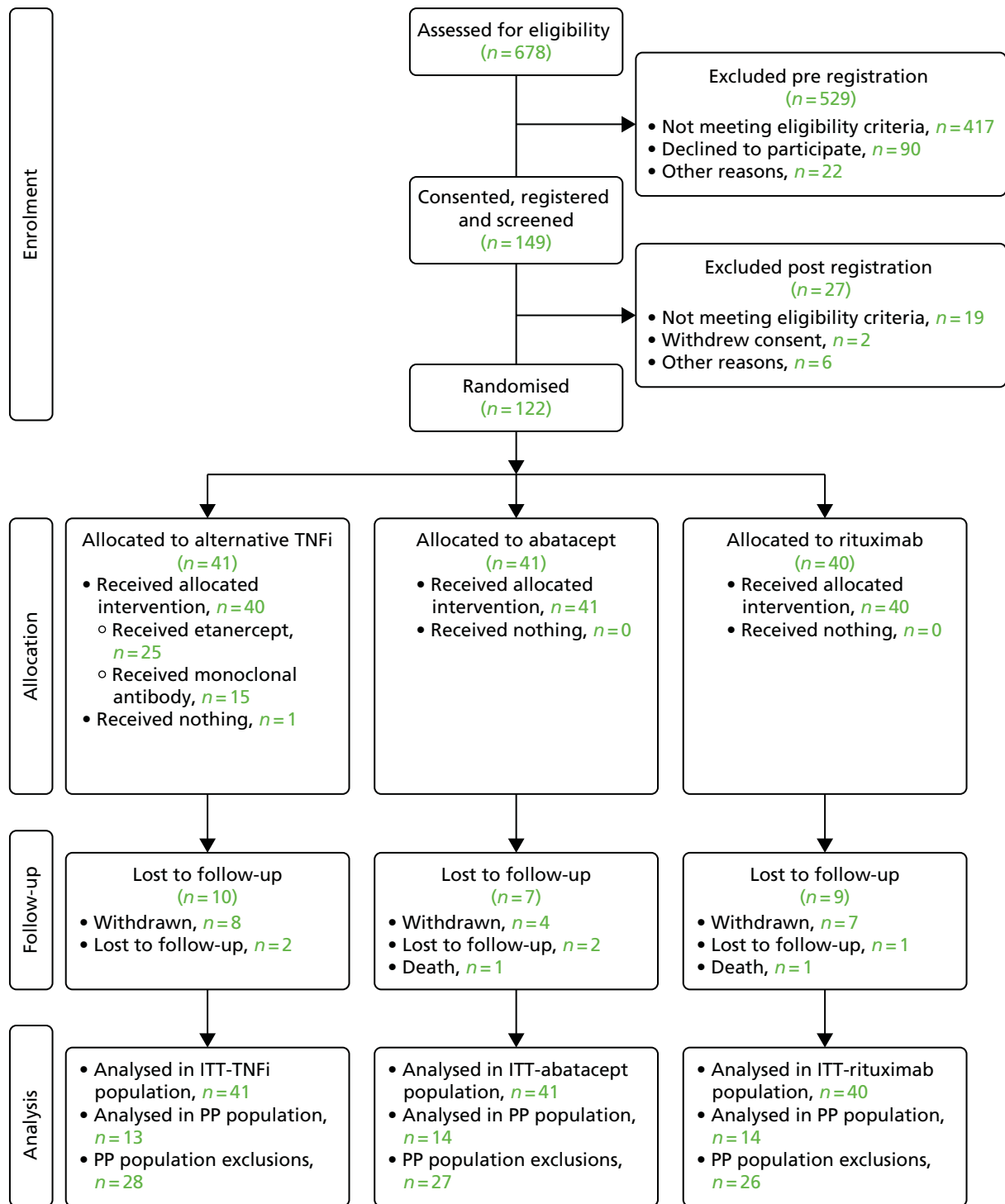
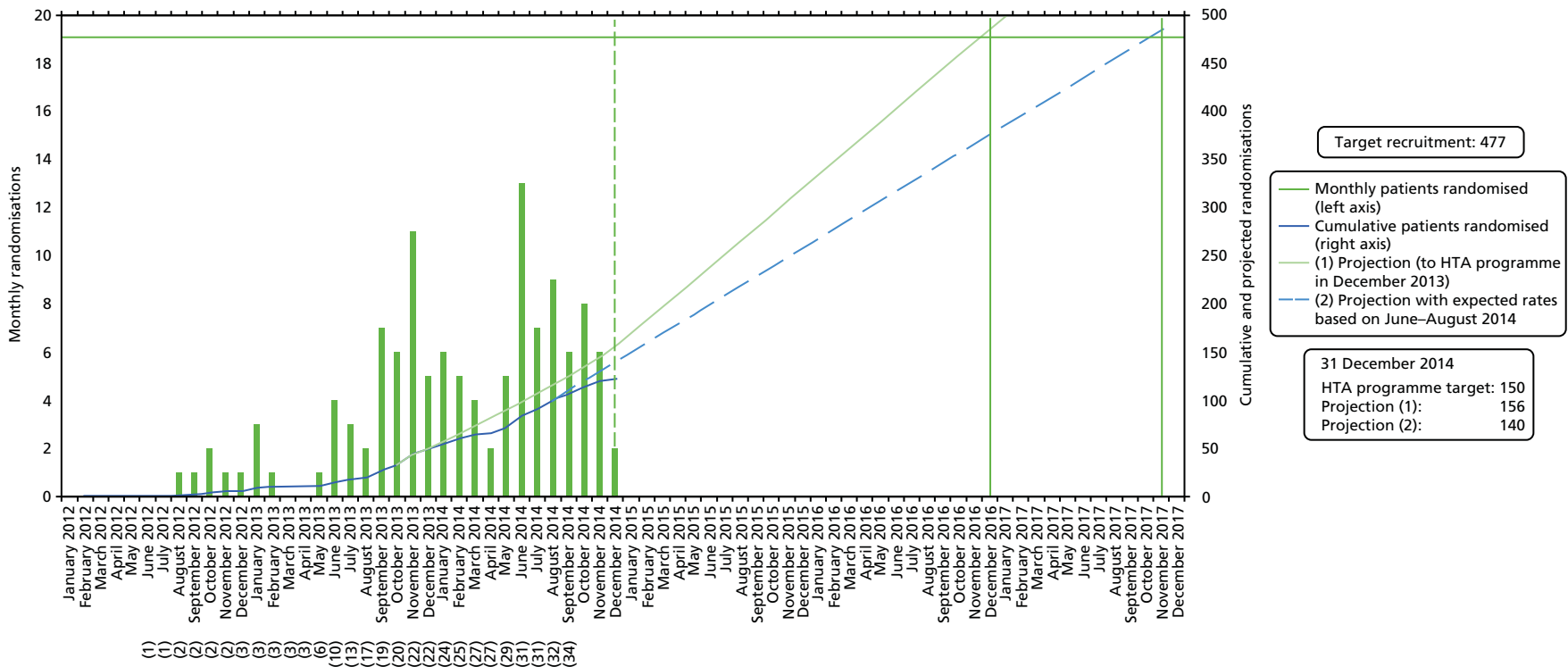

FIGURE 2 The flow of patients through the SWITCH trial (Consolidated Standards of Reporting Trials diagram).

Of the 122 patients randomised to the treatment group, 41 were allocated to alternative TNFi, 41 were allocated to abatacept and 40 were allocated to rituximab.

The median time from the centre opening to randomisation of the first patient was 3.8 months (95% CI 2.5 to 7 months). Two centres did not randomise their first patient until more than 12 months after opening, and two further centres recruited no patients despite being open for more than 12 months.



**FIGURE 3** Graph showing actual recruitment and projected recruitment when the trial was terminated. Projection 1 assumes 35 centres opened. Projection 2 assumes 31 centres opened. (XX), number of centres open.

### Generalisability of the patient population randomised

Summaries of the clinical and demographic variables collected on the non-registration logs for patients considered for enrolment, registered but not randomised, and for patients randomised are provided in *Appendix 9, Table 44*. Age distribution and sex of registered, consented and non-randomised patients were similar. The proportion of patients who were RF seropositive or ACPA positive was also similar between patients registered but not randomised and those patients who were randomised; however, there was a large proportion of patients for whom RF and ACPA status was unknown among non-registered patients, making an assessment of generalisability on RF/ACPA status difficult.

### Withdrawals

A summary of follow-up attendance up to the end of the 48-week intervention phase is provided in *Figure 4*.

Six patients withdrew consent to continue with randomised treatment and follow-up, two patients on alternative TNFi, one on abatacept and three on rituximab. Two further patients, one on alternative TNFi and one on abatacept, withdrew from follow-up during the observational period after week 48. An additional patient (2.4%) on abatacept withdrew from treatment but continued to have follow-up assessments and a further patient, also on abatacept (2.4%), was withdrawn from the study because of an AE (chest infection).

*Appendix 9, Table 45* provides a full list of the reasons for withdrawal.

Two patients on alternative TNFi were lost to follow-up by 48 weeks: one patient (2.4%) on abatacept and one on rituximab.

### Protocol deviations

Two patients were eligibility violations, one randomised to alternative TNFi and one to rituximab, both of whom continued to receive their allocated treatment and were followed up. One patient had juvenile-onset RA and one received sulfasalazine and hydroxychloroquine prior to the start of protocol treatment, had not received MTX and had started taking NSAIDs (naproxen) within 4 weeks prior to the screening visit.

A further patient randomised to alternative TNFi had a susceptibility to myeloma if given a monoclonal antibody and a clinical judgement was made to withdraw this patient before the allocated treatment and follow-up.

Eighty-one patients (66.4%) deviated from the protocol in some way, which resulted in exclusion from the PP population, corresponding to 28 (68.3%) patients on alternative TNFi, 27 (65.9%) on abatacept and 26 (65.0%) on rituximab. The most common protocol deviation was receiving steroid treatment within 6 weeks of an end-point assessment (35 patients; 28.7%), followed by not being compliant with treatment up to week 24 (based on information obtained via direct questioning) (27 patients; 22.1%), and receiving additional contraindicated treatment (23 patients; 18.9%). *Appendix 10, Table 46*, provides a further summary of reasons for protocol deviations resulting in exclusion from the PP population.

### Treatment compliance

All except one patient received their allocated treatment. One patient was randomised to receive alternative TNFi (monoclonal antibody) but before treatment commenced the treating clinician withdrew

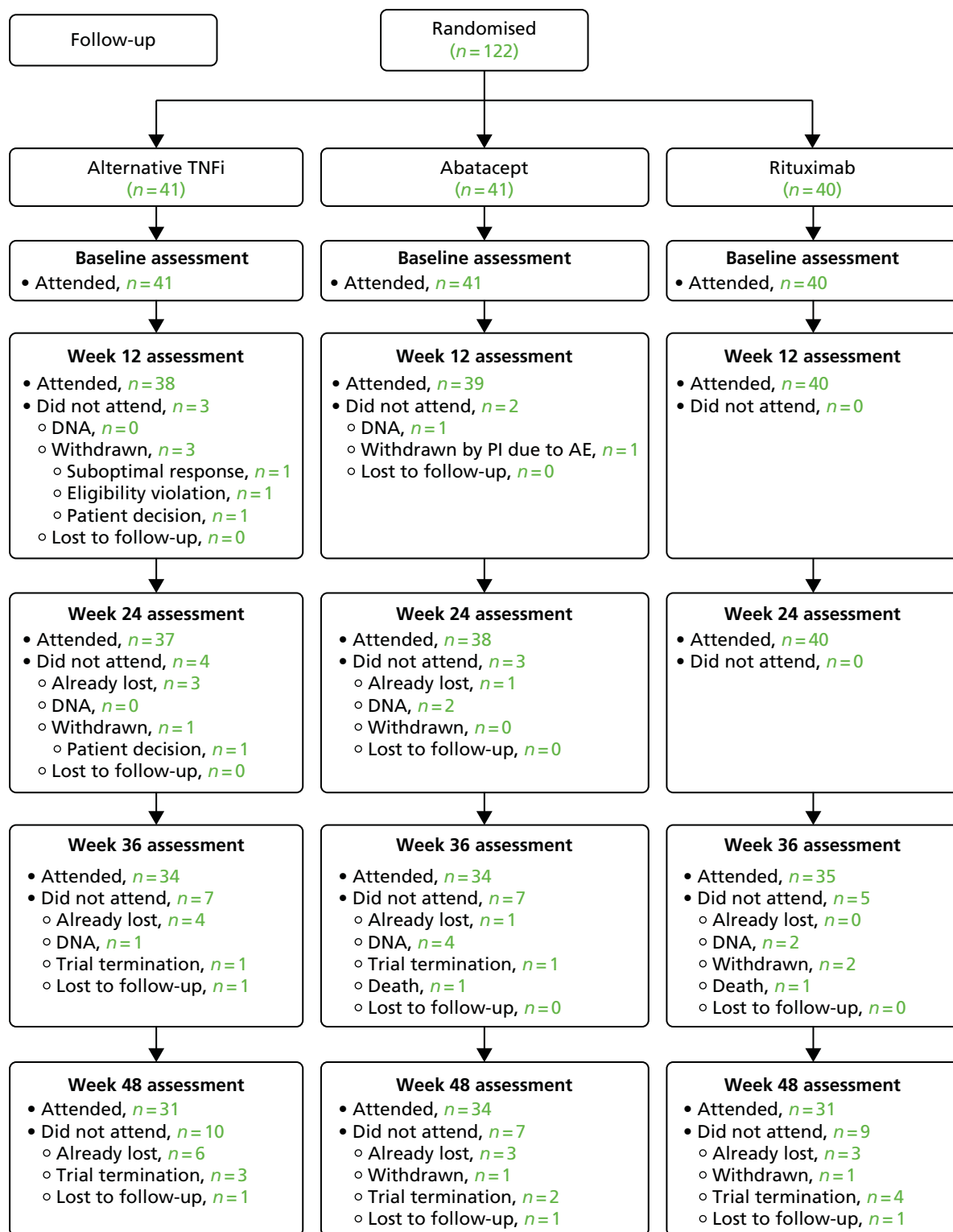

**FIGURE 4** Summary of follow-up attendance up to the end of the 48-week intervention phase. DNA, did not attend.

the patient because of the presence of a comorbidity that precluded treatment with a monoclonal antibody TNFi.

### ***Rituximab***

All 40 patients randomised to rituximab received at least one infusion of rituximab. By week 12, all infusions had been given in line with the protocol, although infusions for four patients had been delayed (because of patient choice, clinician examination delaying first dose, AE and out-of-range pre-treatment tests). A total of 35 (87.5%) patients were known to be at least 80% compliant with treatment up to week 24.

### ***Abatacept***

All 41 patients randomised to receive abatacept received at least one injection of abatacept. A total of 29 patients (70.7%) were known to be at least 80% compliant with treatment up to week 24.

### ***Alternative tumour necrosis factor inhibitor***

Forty out of 41 patients (97.6%) randomised to the alternative TNFi treatment arm received their allocated treatment. A total of 31 patients (75.6%) were known to be at least 80% compliant with their randomised treatment up to week 24.

### **Etanercept**

Twenty-five patients were assigned to receive etanercept as a result of being randomised to alternative TNFi. All 25 received at least one injection of etanercept.

### **Monoclonal antibody**

The remaining 16 patients randomised to an TNFi were assigned to receive a monoclonal antibody, the choice of which was at the clinician's discretion.

### ***Adalimumab***

Ten patients received adalimumab as a result of allocation to a monoclonal antibody and all 10 received at least one injection.

### ***Certolizumab pegol***

Only one patient received CZP as a result of allocation to a monoclonal antibody. With the exception of one missed injection between baseline and week 12, this patient received all injections in line with the protocol up to week 36.

### ***Golimumab***

Three patients received golimumab as a result of allocation to a monoclonal antibody. All three patients received all injections to at least week 24.

### ***Infliximab***

One patient received infliximab as a result of allocation to alternative TNFi. Up to week 24, infusions were delivered in line with the protocol.

## **Baseline characteristics**

Baseline characteristics are presented in *Tables 2–6*. The mean age was 56.7 years (SD 12.2 years; range 24–81 years). A total of 102 patients (83.6%) were female.

### ***Minimisation factors***

The median disease duration was 6.7 years (range 0.4–43.5 years) (see *Table 2*). Seventy-seven patients (63.1%) were secondary non-responders and 100 patients (82.0%) were RF seropositive or ACPA positive.



**TABLE 2** Summary of minimisation factors at baseline: ITT patient population

Minimisation factor	Treatment arm			Total (n = 122)
	Alternative TNFi (n = 41)	Abatacept (n = 41)	Rituximab (n = 40)	
Disease duration category, n (%)				
< 5 years	16 (39.0)	15 (36.6)	14 (35.0)	45 (36.9)
≥ 5 years	25 (61.0)	26 (63.4)	26 (65.0)	77 (63.1)
Disease duration (years)				
Median (IQR)	5.9 (3.9–12.3)	6.9 (4.0–15.4)	7.0 (3.9–15.6)	6.7 (3.9–14.2)
Range	0.4–35.2	0.6–43.5	1.3–33.7	0.4–43.5
Missing	0	1	0	1
RA/ACPA seropositivity, n (%)				
RF seropositive or ACPA positive	36 (87.8)	31 (75.6)	33 (82.5)	100 (82.0)
Both RF seronegative and ACPA negative	5 (12.2)	10 (24.4)	7 (17.5)	22 (18.0)
Non-response category, n (%)				
Primary	15 (36.6)	15 (36.6)	15 (37.5)	45 (36.9)
Secondary	26 (63.4)	26 (63.4)	25 (62.5)	77 (63.1)

**TABLE 3** Summaries of patient characteristics at baseline: ITT patient population

Patient characteristic	Treatment arm			Total (n = 122)
	Alternative TNFi (n = 41)	Abatacept (n = 41)	Rituximab (n = 40)	
Sex, n (%)				
Male	8 (19.5)	2 (4.9)	10 (25.0)	20 (16.4)
Female	33 (80.5)	39 (95.1)	30 (75.0)	102 (83.6)
Patient age (years)				
Mean (SD)	54.2 (9.98)	58.1 (13.89)	57.8 (12.37)	56.7 (12.21)
Median (IQR)	56.9 (45.5–59.8)	60.5 (45.2–66.9)	57.0 (52.4–67.4)	57.3 (46.7–65.4)
Range	34.2–73.6	28.8–81.7	24.5–81.1	24.5–81.7
Body mass index (kg/m <sup>2</sup> )				
Mean (SD)	30.1 (7.25)	29.2 (5.74)	30.4 (6.80)	29.9 (6.60)
Median (IQR)	28.7 (25.0–34.0)	28.4 (24.3–34.5)	29.0 (25.4–33.5)	29.0 (24.9–34.1)
Missing	1	2	2	5
Smoking status, n (%)				
Non-smoking (never smoked)	12 (29.3)	17 (41.5)	21 (52.5)	50 (41.0)
Past smoker	18 (43.9)	13 (31.7)	11 (27.5)	42 (34.4)
Current smoker	11 (26.8)	11 (26.8)	8 (20.0)	30 (24.6)

continued

**TABLE 3** Summaries of patient characteristics at baseline: ITT patient population (*continued*)

Patient characteristic	Treatment arm			Total (n = 122)
	Alternative TNFi (n = 41)	Abatacept (n = 41)	Rituximab (n = 40)	
Prior comorbidities, n (%)				
Hypertension	15 (36.6)	13 (31.7)	14 (35.0)	42 (34.4)
Osteoarthritis	11 (26.8)	14 (34.1)	8 (20.0)	33 (27.0)
Hypercholesterolaemia	7 (17.1)	8 (19.5)	10 (25.0)	25 (20.5)
Depression	7 (17.1)	7 (17.1)	4 (10.0)	18 (14.8)
Thyroid dysfunction	8 (19.5)	5 (12.2)	2 (5.0)	15 (12.3)
Asthma	6 (14.6)	3 (7.3)	4 (10.0)	13 (10.7)
Diabetes	4 (9.8)	1 (2.4)	5 (12.5)	10 (8.2)
Cancer	3 (7.3)	1 (2.4)	1 (2.5)	5 (4.1)
Bowel disease	–	2 (4.9)	1 (2.5)	3 (2.5)
Ischaemic heart disease	1 (2.4)	–	2 (5.0)	3 (2.5)
Emphysema/chronic bronchitis	1 (2.4)	1 (2.4)	–	2 (1.6)
Myocardial infarction	–	–	2 (5.0)	2 (1.6)
Peptic ulcer disease	–	1 (2.4)	1 (2.5)	2 (1.6)
Stroke	–	1 (2.4)	1 (2.5)	2 (1.6)
Chronic liver disease	1 (2.4)	–	–	1 (0.8)
Epilepsy	1 (2.4)	–	–	1 (0.8)
Peripheral vascular disease	–	–	1 (2.5)	1 (0.8)
Renal disease	–	1 (2.4)	–	1 (0.8)

IQR, interquartile range.

**TABLE 4** Summary of treatment histories at baseline: ITT patient population

Treatment history	Treatment arm, n (%)			Total (n = 122), n (%)
	Alternative TNFi (n = 41)	Abatacept (n = 41)	Rituximab (n = 40)	
Type of initial TNFi that failed				
Monoclonal antibody	25 (61.0)	23 (56.1)	22 (55.0)	70 (57.4)
Etanercept	16 (39.0)	18 (43.9)	18 (45.0)	52 (42.6)
Previous TNFi agent				
Adalimumab	10 (24.4)	10 (24.4)	8 (20.0)	28 (23.0)
CZP	11 (26.8)	9 (22.0)	5 (12.5)	25 (20.5)
Etanercept	16 (39.0)	18 (43.9)	18 (45.0)	52 (42.6)
Golimumab	2 (4.9)	–	4 (10.0)	6 (4.9)
Infliximab	2 (4.9)	4 (9.8)	5 (12.5)	11 (9.0)

**TABLE 5** Summary of baseline disease activity: ITT patient population

Measure of disease activity	Treatment arm			Total (n = 122)
	Alternative TNFi (n = 41)	Abatacept (n = 41)	Rituximab (n = 40)	
Experience early-morning stiffness?, n (%)				
Yes	39 (95.1)	39 (95.1)	40 (100.0)	118 (96.7)
No	2 (4.9)	2 (4.9)	–	4 (3.3)
TJC				
Mean (SD)	15.3 (6.40)	15.1 (7.39)	17.4 (8.13)	15.9 (7.33)
Missing	0	0	1	1
SJC				
Mean (SD)	9.9 (6.43)	8.8 (5.54)	10.0 (6.64)	9.5 (6.19)
Missing	0	0	1	1
ESR (mm/hour)				
Median (IQR)	19.0 (8.0–27.0)	34.0 (17.0–54.0)	27.0 (9.0–44.0)	26.0 (11.0–43.0)
Missing	0	2	2	4
CRP level (mg/l)				
Median (IQR)	5.0 (4.0–15.5)	9.0 (5.0–27.0)	6.0 (5.0–15.0)	6.0 (5.0–18.0)
Missing	1	2	1	4
DAS28				
Mean (SD)	5.9 (1.05)	6.2 (1.08)	6.2 (1.28)	6.1 (1.13)
Missing	1	3	5	9
CDAI score				
Mean (SD)	38.6 (13.12)	36.6 (13.34)	39.6 (13.68)	38.3 (13.31)
Missing	1	3	4	8
SDAI score				
Mean (SD)	39.8 (13.98)	38.8 (13.87)	41.9 (14.49)	40.2 (14.04)
Missing	2	5	5	12
Physician Global Assessment of Disease Activity VAS (mm)				
Median (IQR)	67.0 (56.0–75.0)	66.0 (58.0–84.0)	65.0 (53.0–84.2)	66.0 (57.0–79.0)
Missing	0	2	1	3

IQR, interquartile range.

### Demographics

Ninety patients (73.8%) had a current comorbidity, with the most frequently reported being hypertension (42 patients; 34.4%), osteoarthritis (33 patients; 27.0%) and hypercholesterolaemia (25 patients; 20.5%) (see *Table 3*).

### Treatment history

Seventy patients (57.4%) had previously failed to respond to a monoclonal antibody TNFi agent. The most common first TNFi agent used was etanercept (52 patients; 42.6%), followed by adalimumab (28 patients; 23.0%) and then CZP (25 patients; 20.5%) (see *Table 4*).

**TABLE 6** Summaries of variables used as patient-reported outcomes measured at baseline: ITT patient population

Patient-reported outcome measure	Treatment arm			Total (n = 122)
	Alternative TNFi (n = 41)	Abatacept (n = 41)	Rituximab (n = 40)	
Patient Global Assessment of Arthritis VAS (mm)				
Median (IQR)	70.5 (62.0–83.0)	67.5 (52.0–79.5)	74.0 (53.0–85.0)	71.0 (56.0–83.0)
Missing	1	1	3	5
Patient Assessment of General Health VAS (mm)				
Median (IQR)	56.5 (45.5–72.0)	62.0 (47.8–68.5)	61.0 (46.0–74.0)	59.0 (47.0–70.0)
Missing	1	1	3	5
Patient Global Assessment of Pain VAS (mm)				
Median (IQR)	70.5 (59.0–82.5)	69.5 (57.5–79.0)	77.0 (55.0–85.0)	71.0 (58.0–81.0)
Missing	1	1	3	5
HAQ-DI score				
Median (IQR)	1.9 (1.4–2.1)	1.9 (1.6–2.3)	1.9 (1.4–2.3)	1.9 (1.5–2.1)
Missing	1	1	1	3
RAQoL score				
Median (IQR)	21.6 (15.0–24.5)	22.0 (14.0–25.5)	22.0 (15.0–25.0)	22.0 (15.0–25.0)
Missing	1	1	2	4
HADS score				
Median (IQR)	13.5 (8.0–20.0)	17.0 (10.0–22.0)	14.0 (11.0–19.0)	15.0 (10.0–21.0)
Missing	1	1	3	5

IQR, interquartile range.

A total of 24 patients (19.7%) had received some form of steroid or corticosteroid within 4 weeks of screening, with oral prednisolone the most frequently reported (22 patients; 18.0%). Sixty patients (49.2%) reported receiving NSAIDs within 4 weeks of screening, with naproxen, diclofenac and ibuprofen most frequently reported. The most common non-bDMARDs used prior to participating were sulfasalazine (91 patients; 74.6%), hydroxychloroquine (84 patients; 68.9%) and leflunomide (26 patient; 21.3%) (see *Appendix 11*).

### **Baseline disease activity and individual component measures**

The mean number of TJs and SJs at baseline was 15.9 (SD 7.3) and 9.5 (SD 6.2), respectively. The median ESR was 26.0 mm/hour (quartiles 11.0 mm/hour and 43.0 mm/hour) and the median CRP level was 6.0 mg/l (quartiles 5.0 mg/l and 18.0 mg/l) (see *Table 5*).

The mean DAS28 at baseline was 6.1 units (SD 1.1 units), with 76.2% patients having high disease activity (see *Table 5* and *Appendix 12, Table 59*). The mean CDAI score was 38.3 (SD 13.3), with 82.0% patients categorised as having high disease activity (see *Table 5* and *Appendix 12, Table 63*). Furthermore, the mean SDAI score was 40.2 (SD 14.0) and 77.9% patients were categorised as having high disease activity (see *Table 5* and *Appendix 12, Table 65*).

The median Physician Global Assessment Disease Activity score was 66.0 (quartiles 57.0 and 79.0).

### Baseline patient-reported outcomes

The median global assessment of arthritis, general health and pain scores, as rated by the patient, were 71.0 (quartiles 56.0 and 83.0), 59.0 (quartiles 47.0 and 70.0) and 71.0 (quartiles 58.0 and 81.0), respectively (see *Table 6*). The median HAQ-DI score was 1.9 (quartiles 1.5 and 2.1), the median RAQoL score was 22.0 (quartiles 15.0 and 25.0) and the median HADS score was 15.0 (quartiles 10.0 and 21.0) (see *Table 6*).

### Comparability of baseline characteristics between groups

The baseline characteristics were balanced across the three treatment groups, with the following notable exceptions. A higher percentage of females were randomised to abatacept (95.1%, compared with 80.5% and 75.0% randomised to alternative TNFi and rituximab, respectively). A greater proportion of patients in the alternative TNFi or abatacept arms were current or past smokers (70.7% and 68.5%, respectively) than in the rituximab arm (47.5%). A higher proportion of patients on abatacept had osteoarthritis, whereas more patients on rituximab had a history of hypercholesterolaemia. A greater proportion of patients on alternative TNFi and abatacept had a history of depression and also a history of thyroid dysfunction. Furthermore, a slightly greater proportion of patients on the alternative TNFi or rituximab had a history of diabetes (see *Table 3*). A slight imbalance in the RF/ACPA status was apparent, whereby a greater proportion of patients on alternative TNFi were seropositive than those taking abatacept and rituximab (see *Table 2*). The slight imbalances observed are consistent with the random allocation to the treatment group and result from the small sample size.

*Tables 47–51* in *Appendix 10* summarise the baseline characteristics for the PP population.

## Primary and secondary outcomes

Although the results are presented in accordance with the planned analysis, the trial is underpowered for our planned objectives relating to the primary and secondary outcome measures.

### Primary outcome

#### Intention-to-treat patient population

*Tables 7* and *8* and *Figure 5* present the results of the primary end-point analysis for the ITT patient population.

**TABLE 7** Primary end-point analysis: multivariable linear regression analysis for a reduction in the DAS28 at 24 weeks post randomisation – ITT patient population

Effect	Estimate	95% CI	p-value
Intercept	1.50	0.72 to 2.28	< 0.001
Randomised treatment: alternative TNFi vs. rituximab	0.30	–0.45 to 1.05	0.436
Randomised treatment: abatacept vs. rituximab	0.04	–0.72 to 0.79	0.927
RF/anti-CCP seropositivity: both seronegative vs. either seropositive	–0.17	–1.00 to 0.66	0.690
Disease duration: ≥ 5 years vs. < 5 years	–0.05	–0.70 to 0.60	0.883
Non-responder type: secondary vs. primary	–0.45	–1.11 to 0.21	0.181

CCP, cyclic citrullinated peptide.

**TABLE 8** Adjusted mean reduction in the DAS28 and the corresponding difference between alternative TNFi, abatacept and rituximab at 24 weeks post randomisation – ITT patient population

Treatment arm	Adjusted mean DAS28 reduction at week 24 (95% CI)	Treatment comparison	Difference in mean DAS28 reductions (experimental – rituximab 95% CI)	Probability <sup>a</sup> ( $\delta > -0.6$ )
Rituximab (n = 40)	1.17 (0.56 to 1.77)	–	–	–
Alternative TNFi (n = 41)	1.47 (0.85 to 2.08)	Alternative TNFi vs. rituximab	0.30 (–0.45 to 1.05)	0.0094
Abatacept (n = 41)	1.20 (0.62 to 1.78)	Abatacept vs. rituximab	0.04 (–0.72 to 0.79)	0.0493

a One-sided *p*-value corresponding to the one-sided 97.5% test for non-inferiority of alternative TNFi/abatacept compared with rituximab using the lower margin of –0.6 units; the one-sided *p*-value needs to be < 0.025 to conclude non-inferiority with rituximab.

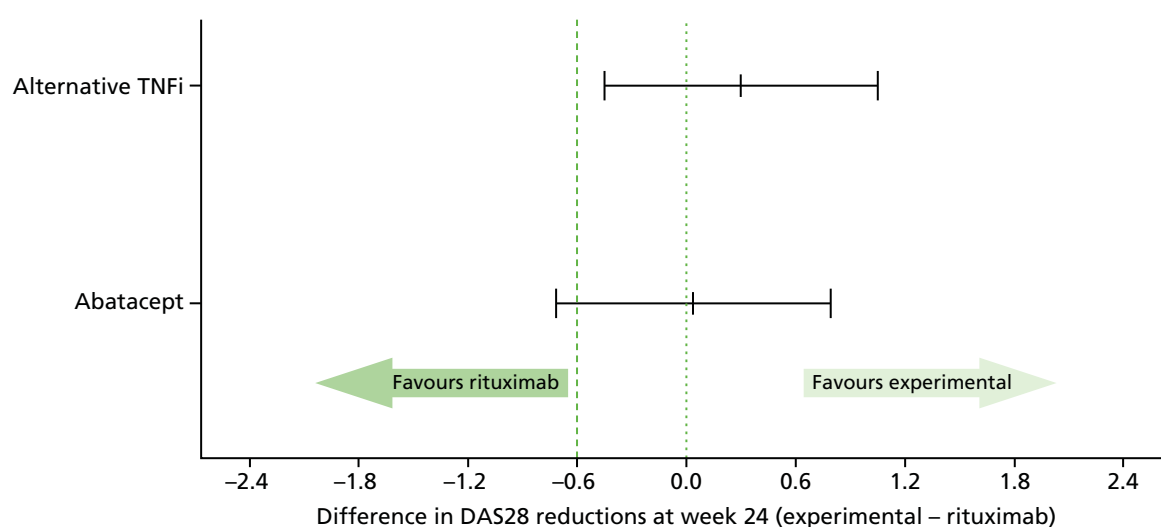

**FIGURE 5** Primary end-point analysis: difference in mean reduction in the DAS28 at 24 weeks post randomisation between alternative TNFi, abatacept and rituximab – ITT population analysis. The dotted line at zero is the null difference value and the thick dashed line denotes the non-inferiority margin.

For the comparison between alternative TNFi and rituximab, the lower limit of the 95% CI for the difference in the mean reduction in the DAS28 lies above the predefined, non-inferiority limit of –0.6 units; the difference in the mean reduction in DAS28 (alternative TNFi – rituximab) at 24 weeks post randomisation was 0.3 units (95% CI –0.45 to 1.05 units). Therefore, alternative TNFi was non-inferior to rituximab in the ITT patient population.

For the comparison between abatacept and rituximab, the lower limit of the 95% CI lay just below the predefined non-inferiority limit; the difference in mean reduction in the DAS28 at 24 weeks (abatacept – rituximab) was 0.04 units (95% CI –0.72 to 0.79 units). Therefore, abatacept was not shown to be non-inferior to rituximab in the ITT patient population.

Summaries of the missing values for the component end points of the DAS28 by treatment group are presented in *Appendix 13, Tables 69 and 70*.

### Sensitivity analysis

*Table 9* and *Figure 6* present results of the sensitivity analysis on the primary end point for the ITT patient population, adjusting for the baseline DAS28.

**TABLE 9** Sensitivity analysis: adjusted mean reduction in DAS28 and corresponding difference between alternative TNFi, abatacept and rituximab at 24 weeks post randomisation – ITT patient population

Treatment arm	Adjusted mean DAS28 reduction at week 24 (95% CI)	Treatment comparison	Baseline-adjusted difference in mean DAS28 reductions (experimental – rituximab 95% CI)	Probability <sup>a</sup> ( $\delta > 0.6$ )
Rituximab ( $n = 40$ )	1.07 (0.53 to 1.60)	–	–	–
Alternative TNFi ( $n = 41$ )	1.60 (1.05 to 2.15)	Alternative TNFi vs. rituximab	0.54 (–0.12 to 1.20)	< 0.001
Abatacept ( $n = 41$ )	1.11 (0.60 to 1.62)	Abatacept vs. rituximab	0.05 (–0.61 to 0.70)	0.026

a One sided  $p$ -value corresponding to one-sided 97.5% test for non-inferiority of alternative TNFi/abatacept compared with rituximab using the lower margin of –0.6 units; the one sided  $p$ -value needs to be < 0.025 to conclude non-inferiority with rituximab.

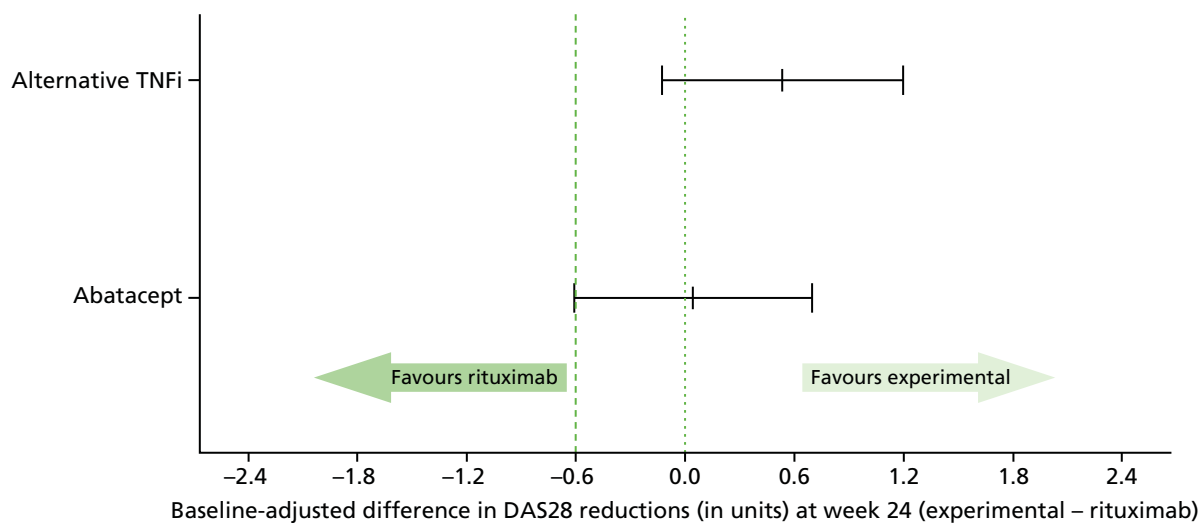
**FIGURE 6** Sensitivity analysis on the primary end point: difference in the mean reduction in the DAS28 at 24 weeks post randomisation between alternative TNFi, abatacept and rituximab.

For the comparison between alternative TNFi and rituximab, the lower limit of the 95% CI for the difference in the mean reduction in the DAS28 lies above the predefined non-inferiority limit of –0.6 units; the difference in mean reduction in the DAS28 (alternative TNFi – rituximab) at 24 weeks post randomisation was 0.54 units (95% CI –0.12 to 1.20 units). Therefore, again alternative TNFi was non-inferior to rituximab in the ITT patient population.

For the comparison between abatacept and rituximab, the lower limit of the 95% CI lay just below the predefined non-inferiority limit; the difference in the mean reduction in the DAS28 at 24 weeks (abatacept – rituximab) was 0.05 units (95% CI –0.61 to 0.70 units). Therefore, there was only marginal evidence that abatacept was non-inferior to rituximab in the ITT patient population.

### Per protocol population

A total of 41 patients were included in the PP population with 13 (31.7%), 14 (34.1%) and 14 (35.0%) in alternative TNFi, abatacept and rituximab treatment groups, respectively. Owing to the small number of patients in the PP population, only the primary outcome has been analysed.

Tables 10 and 11 and Figure 7 provide the results of the primary end-point analysis for the PP population.

**TABLE 10** Primary end-point analysis: multivariable linear regression analysis for a reduction in the DAS28 at 24 weeks post randomisation – PP population

Effect	Estimate	95% CI	p-value
Intercept	2.07	0.91 to 3.23	0.001
Randomised treatment: alternative TNFi vs. rituximab	-0.58	-1.72 to 0.55	0.312
Randomised treatment: abatacept vs. rituximab	-0.15	-1.27 to 0.98	0.796
RF/anti-CCP seropositivity: both seronegative vs. either seropositive	-0.73	-1.96 to 0.50	0.245
Disease duration: ≤ 5 years vs. > 5 years	-0.05	-1.10 to 1.01	0.930
Non-responder type: secondary vs. primary	-0.05	-0.99 to 0.88	0.908

CCP, cyclic citrullinated peptide.

**TABLE 11** Adjusted mean reduction in the DAS28 and corresponding difference between alternative TNFi, abatacept and rituximab at 24 weeks post randomisation – PP population

Treatment group	Adjusted mean DAS28 reduction at week 24 (95% CI)	Treatment comparison	Difference in mean DAS28 reductions (experimental – rituximab 95% CI)	Probability <sup>a</sup> ( $\delta > -0.6$ )
Rituximab (n = 14)	1.66 (0.77 to 2.55)	–	–	–
Alternative TNFi (n = 13)	1.07 (0.11 to 2.03)	Alternative TNFi vs. rituximab	-0.58 (-1.72 to 0.55)	0.489
Abatacept (n = 14)	1.51 (0.70 to 2.31)	Abatacept vs. rituximab	-0.15 (-1.27 to 0.98)	0.216

a One-sided p-value corresponding to the one-sided 97.5% test for non-inferiority of alternative TNFi/abatacept compared with rituximab using the lower margin of -0.6 units; the one-sided p-value needs to be < 0.025 to conclude non-inferiority with rituximab.

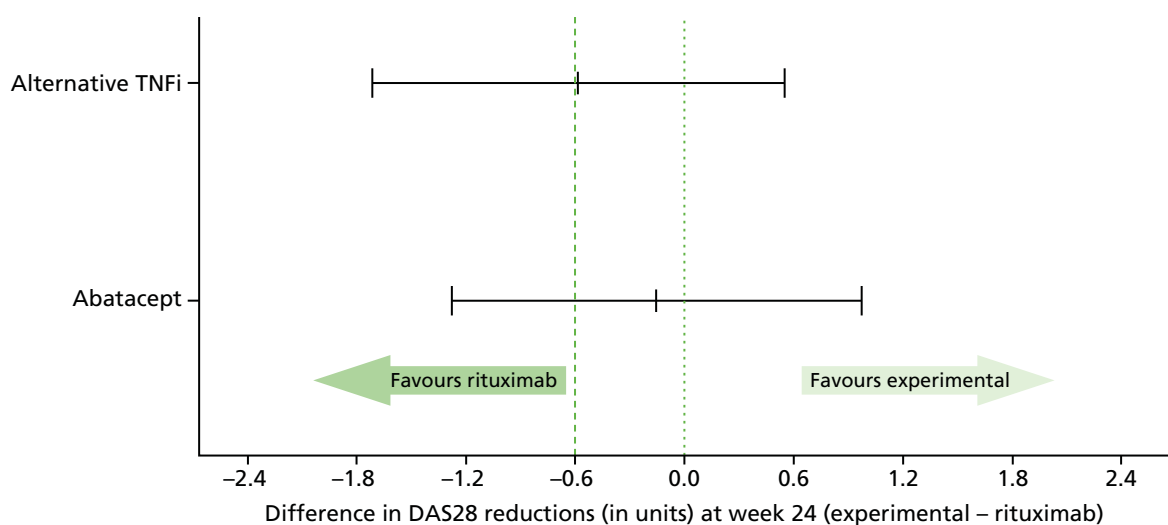

**FIGURE 7** Primary end-point analysis: difference in the mean reduction in the DAS28 at 24 weeks post randomisation between alternative TNFi, abatacept and rituximab – PP population.



For the comparison of alternative TNFi versus rituximab, the lower limit of the 95% CI for the difference in the mean reduction in the DAS28 was below the predefined non-inferiority limit of  $-0.6$  units; the difference in the mean reduction in the DAS28 at 24 weeks post randomisation (alternative TNFi – rituximab) was  $-0.58$  units (95% CI  $-1.72$  to  $0.55$  units). Therefore, non-inferiority of alternative TNFi to rituximab was not demonstrated in the PP population and so we cannot conclude that alternative TNFi is non-inferior to rituximab.

Similarly, for the comparison of abatacept versus rituximab, the lower limit of the 95% CI for the difference in the mean reduction in the DAS28 was below  $-0.6$  units; the difference in the mean reduction in the DAS28 at 24 weeks post randomisation (abatacept – rituximab) was  $-0.15$  units (95% CI  $-1.27$  to  $0.98$  units). Therefore, non-inferiority of abatacept to rituximab was not demonstrated in the PP population. Hence, a conclusion of non-inferiority of abatacept to rituximab was not reached in both analyses (although in an underpowered cohort).

### Complete-case analysis population

The primary end-point analysis was also conducted on the population of all patients with complete data at both baseline and week 24. *Table 12* and *Figure 8* provide the results of the primary end-point analysis in the complete-case analysis population.

For both alternative TNFi and abatacept, the lower limit of the 95% CI for the true difference in the mean reduction in the DAS28 lay just below the predefined non-inferiority limit of  $-0.6$  units. The difference in the mean reduction in the DAS28 at 24 weeks post randomisation for alternative TNFi compared with rituximab was  $0.10$  units (95% CI  $-0.71$  to  $0.91$  units) and for abatacept relative to rituximab was  $-0.04$  units (95% CI  $-0.86$  to  $0.79$  units). Therefore, non-inferiority of alternative TNFi and abatacept to rituximab was not demonstrated in the complete-case analysis population.

Summary statistics for the DAS28 at baseline, week 24 and the corresponding reduction for the complete-case population is summarised in *Appendix 12, Table 58*.

### Exploratory subgroup analysis

*Table 13* presents the least squares means and corresponding 95% CIs of the reduction in the DAS28 at week 24 by RF/ACPA seropositivity status, initial TNFi type and non-responder status to an initial bDMARD for the ITT population; corresponding summary statistics for the complete-case population are provided in *Appendix 12, Table 53*. The results of the subgroup analysis are not sufficiently precise to draw definitive conclusions and, therefore, only informal comparisons between treatment groups were made. All results should be interpreted cautiously.

**TABLE 12** Adjusted mean reduction in the DAS28 and corresponding difference between alternative TNFi, abatacept and rituximab at 24 weeks post randomisation – complete-case population

Treatment group	Adjusted mean DAS28 reduction at week 24 (95% CI)	Treatment comparison	Difference in mean DAS28 reductions (experimental – rituximab 95% CI)	Probability <sup>a</sup> ( $\delta > -0.6$ )
Rituximab ( $n = 32$ )	1.14 (0.44 to 1.85)	–	–	–
Alternative TNFi ( $n = 36$ )	1.24 (0.57 to 1.91)	Alternative TNFi vs. rituximab	0.10 ( $-0.71$ to $0.91$ )	0.044
Abatacept ( $n = 34$ )	1.10 (0.47 to 1.74)	Abatacept vs. rituximab	$-0.04$ ( $-0.86$ to $0.79$ )	0.090

<sup>a</sup> One-sided  $p$ -value corresponding to the one-sided 97.5% test for non-inferiority of alternative TNFi/abatacept compared with rituximab using the lower margin of  $-0.6$  units; the one-sided  $p$ -value needs to be  $< 0.025$  to conclude non-inferiority with rituximab.

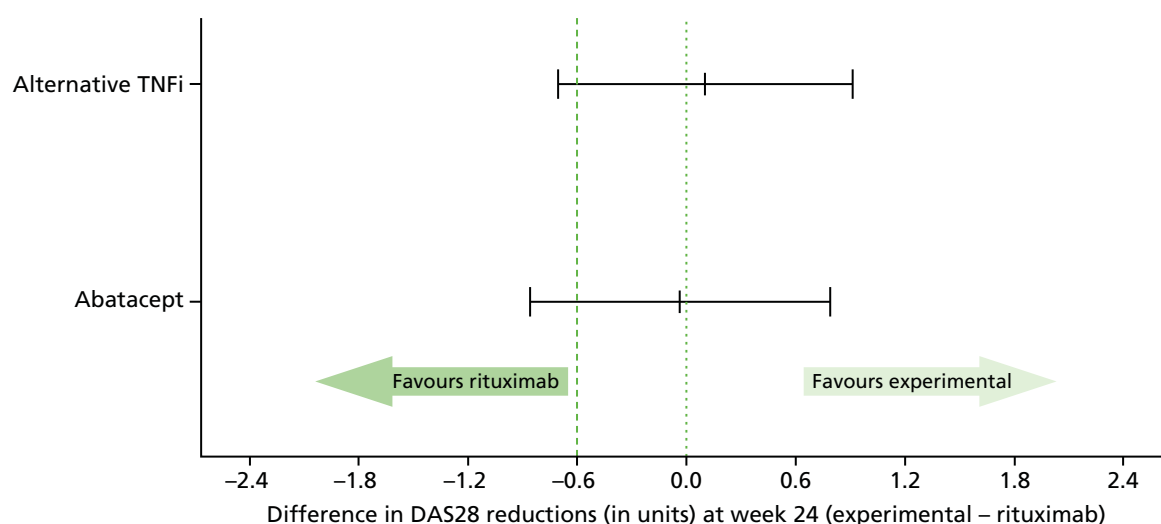

**FIGURE 8** Primary end-point analysis: difference in the mean reduction in the DAS28 at 24 weeks post randomisation between alternative TNFi, abatacept and rituximab – complete-case population.

**TABLE 13** Least squares means (95% CIs) of the DAS28 reduction at week 24 in each subgroup by treatment arm – ITT patient population

Subgroup	Treatment arm, mean (95% CI)		
	Alternative TNFi	Abatacept	Rituximab
RF/ACPA seropositivity status			
Both RF seronegative and ACPA seronegative	1.76 (0.23 to 3.29)	1.64 (0.57 to 2.70)	0.09 (-1.20 to 1.39)
RF seropositive and/or ACPA seropositive	1.50 (0.93 to 2.07)	1.13 (0.50 to 1.75)	1.47 (0.87 to 2.06)
Non-response category			
Primary	1.15 (0.25 to 2.05)	1.84 (0.97 to 2.71)	1.45 (0.56 to 2.35)
Secondary	1.48 (0.72 to 2.24)	0.68 (-0.07 to 1.44)	0.84 (0.09 to 1.58)
Type of TNFi failed			
Etanercept	1.64 (0.71 to 2.56)	1.50 (0.64 to 2.36)	1.38 (0.50 to 2.26)
Monoclonal antibody	1.38 (0.64 to 2.12)	0.99 (0.25 to 1.73)	1.02 (0.26 to 1.78)

### Rheumatoid factor/anti-citrullinated peptide antibody seropositivity effect on treatment response

It was hypothesised that patients who were RF/ACPA seronegative would have a greater response to alternative TNFi or abatacept than to rituximab.

The DAS28 improvements at week 24 among patients who were RF or ACPA seropositive appeared to be similar in the alternative TNFi and rituximab groups, although a small improvement was observed in the abatacept group. However, among patients who were seronegative, no improvement in the rituximab group was apparent, with a greater improvement observed in the alternative TNFi and abatacept groups. However, as only approximately 18% of patients were seronegative, the conclusions that could be drawn are limited.

### Primary or secondary non-responder status (on an initial tumour necrosis factor inhibitor) on treatment response

Primary non-responders appeared to show greater improvement, on average, on abatacept and rituximab than on alternative TNFi, although the reverse was observed for secondary non-response patients.

### Initial alternative tumour necrosis factor inhibitor failed on treatment response

In the case of patients who previously did not respond to etanercept, similar improvements in the DAS28 at week 24 were observed across all treatment groups, although, among those who previously failed to respond to a monoclonal antibody, alternative TNFi (fusion protein, etanercept) appeared to confer a greater improvement than abatacept or rituximab.

## Secondary outcomes

### Disease Activity Score of 28 joints over time

Table 14 provides the parameter estimates for the model for the DAS28 up to week 48. Table 15 presents the adjusted DAS28 and corresponding difference from rituximab at each time point up to week 48.

Figure 9 provides a graphical representation of the adjusted means and corresponding 95% CIs from the model. The covariance matrix is provided in Appendix 12, Table 55.

**TABLE 14** Estimated coefficients from a multivariable covariance pattern model for the DAS28 over 48 weeks post randomisation – ITT patient population

Effect	Parameter estimate	95% CI	p-value
Intercept (rituximab at week 12)	2.72	1.48 to 3.96	< 0.0001
Baseline DAS28	0.38	0.21 to 0.55	< 0.0001
Randomised treatment			
Alternative TNFi vs. rituximab	-0.18	-0.72 to 0.35	0.503
Abatacept vs. rituximab	-0.04	-0.57 to 0.48	0.870
RF/ACPA status: both seronegative vs. either RF/ACPA seropositive	0.19	-0.32 to 0.69	0.475
Years since diagnosis: ≥ 5 years vs. 0–4 years	-0.16	-0.57 to 0.25	0.440
Non-response type: secondary vs. primary	0.13	-0.27 to 0.53	0.524
Visit			
24 weeks	-0.09	-0.54 to 0.36	0.701
36 weeks	-0.14	-0.52 to 0.24	0.477
48 weeks	-0.29	-0.75 to 0.17	0.218
<b>Interaction effect for</b>			
Alternative TNFi			
At 24 weeks	-0.32	-0.96 to 0.33	0.338
At 36 weeks	-0.53	-1.11 to 0.05	0.071
At 48 weeks	-0.20	-0.88 to 0.47	0.552
Abatacept			
At 24 weeks	-0.01	-0.65 to 0.63	0.976
At 36 weeks	0.05	-0.51 to 0.60	0.871
At 48 weeks	0.10	-0.55 to 0.75	0.755

**TABLE 15** Adjusted mean (95% CI) DAS28 and comparisons of alternative TNFi and abatacept with rituximab by assessment time point over 48 weeks

Treatment arm	Adjusted mean (95% CI)	Difference in adjusted means (95% CI)	p-value
12 weeks			
Rituximab	5.09 (4.69 to 5.48)	–	–
Abatacept	5.03 (4.63 to 5.43)	–0.04 (–0.57 to 0.48)	0.870
Alternative TNFi	4.89 (4.47 to 5.32)	–0.18 (–0.72 to 0.35)	0.503
24 weeks			
Rituximab	4.99 (4.50 to 5.47)	–	–
Abatacept	4.93 (4.46 to 5.41)	–0.05 (–0.71 to 0.60)	0.872
Alternative TNFi	4.49 (3.99 to 4.99)	–0.50 (–1.16 to 0.16)	0.137
36 weeks			
Rituximab	4.94 (4.49 to 5.39)	–	–
Abatacept	4.94 (4.49 to 5.39)	0.00 (–0.60 to 0.61)	0.995
Alternative TNFi	4.22 (3.75 to 4.70)	–0.71 (–1.32 to 0.11)	0.022
48 weeks			
Rituximab	4.79 (4.28 to 5.29)	–	–
Abatacept	4.84 (4.38 to 5.31)	0.06 (–0.59 to 0.71)	0.859
Alternative TNFi	4.40 (3.88 to 4.92)	–0.39 (–1.04 to 0.27)	0.249

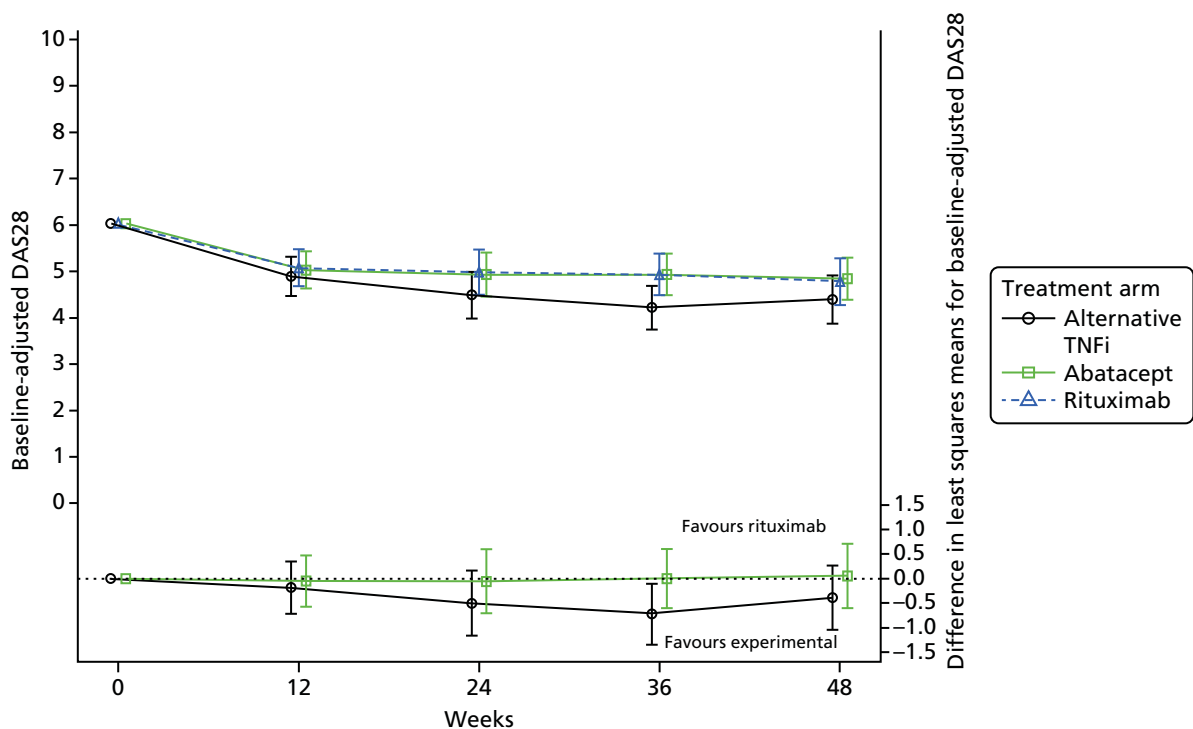

**FIGURE 9** Adjusted mean DAS28 over the 48-week intervention period and the comparisons of alternative TNFi and abatacept with rituximab over 48 weeks. Adjusted mean DAS28 over the 48-week intervention period (top, left axis). Estimated differences between each intervention arm and rituximab at each time point (bottom, right axis).

There was no evidence of a treatment effect for abatacept compared with rituximab at any of the time points (see *Table 15*). This analysis showed significant evidence of a difference between alternative TNFi and rituximab at week 36 (−0.71 units, 95% CI −1.32 to −0.11 units;  $p = 0.022$ ), although this difference was not maintained at week 48.

From 24 weeks post randomisation, the 95% CIs for the mean DAS28 in the alternative TNFi group exclude values greater than 4.99, suggesting that the mean DAS28 for this group is lower than the DAS28 threshold for high disease activity (i.e. DAS28 > 5.1 units). For abatacept and rituximab the estimated 95% CIs for the mean DAS28 include values corresponding to high disease activity at all time points.

### Reduction in the Disease Activity Score of 28 joints of $\geq 1.2$ units over time

The frequency of patients achieving a DAS28 response over 48 weeks for the complete-case population is provided in *Appendix 12, Table 54*.

Parameter estimates for the model are given in *Table 16*. *Table 17* shows the odds of achieving DAS28  $\geq 1.2$  units in each group and the odds ratios relative to rituximab at each time point up to week 48. *Figure 10* provides a graphical representation of the fitted values from the model. The covariance matrix is provided in *Appendix 12, Table 56*.

**TABLE 16** Estimated coefficients for the multivariable covariance pattern model for the DAS28 response over 48 weeks post randomisation: ITT patient population

Effect	Odds ratio (95% CI)	p-value
Intercept		< 0.001
Baseline DAS28	2.23 (1.65 to 3.02)	< 0.001
Randomised treatment		
Alternative TNFi vs. rituximab	1.07 (0.38 to 3.02)	0.904
Abatacept vs. rituximab	1.22 (0.44 to 3.39)	0.701
Seropositivity: RF/ACPA both seronegative vs. either RF/ACPA seropositive	0.74 (0.33 to 1.65)	0.464
Years since diagnosis: $\geq 5$ years vs. 0–4 years	1.56 (0.82 to 2.97)	0.178
Non-response type: secondary vs. primary	0.96 (0.51 to 1.81)	0.888
Visit		
24 weeks	0.98 (0.45 to 2.13)	0.963
36 weeks	1.17 (0.49 to 2.77)	0.726
48 weeks	1.77 (0.64 to 4.90)	0.269
<b>Interaction effect for</b>		
Alternative TNFi		
At 24 weeks	2.37 (0.81 to 6.94)	0.116
At 36 weeks	1.79 (0.56 to 5.72)	0.327
At 48 weeks	1.32 (0.33 to 5.33)	0.699
Abatacept		
At 24 weeks	0.95 (0.33 to 2.76)	0.930
At 36 weeks	0.92 (0.28 to 2.98)	0.888
At 48 weeks	0.75 (0.19 to 2.93)	0.675

**TABLE 17** Adjusted odds of achieving a DAS28 response and the corresponding odds ratios over time

Treatment arm	Adjusted odds ratio of response (95% CI)	Adjusted odds ratio of response vs. rituximab (95% CI)	p-value
12 weeks			
Rituximab	0.65 (0.29 to 1.42)	–	–
Abatacept	0.79 (0.38 to 1.65)	1.22 (0.44 to 3.39)	0.701
Alternative TNFi	0.69 (0.32 to 1.50)	1.07 (0.38 to 3.02)	0.905
24 weeks			
Rituximab	0.64 (0.29 to 1.39)	–	–
Abatacept	0.74 (0.35 to 1.55)	1.16 (0.42 to 3.24)	0.771
Alternative TNFi	1.61 (0.75 to 3.46)	2.53 (0.90 to 7.07)	0.077
36 weeks			
Rituximab	0.76 (0.33 to 1.74)	–	–
Abatacept	0.85 (0.40 to 1.81)	1.12 (0.37 to 3.42)	0.839
Alternative TNFi	1.44 (0.66 to 3.12)	1.91 (0.65 to 5.60)	0.240
48 weeks			
Rituximab	1.15 (0.49 to 2.71)	–	–
Abatacept	1.05 (0.50 to 2.19)	0.91 (0.30 to 2.73)	0.869
Alternative TNFi	1.61 (0.72 to 3.62)	1.40 (0.47 to 4.19)	0.543

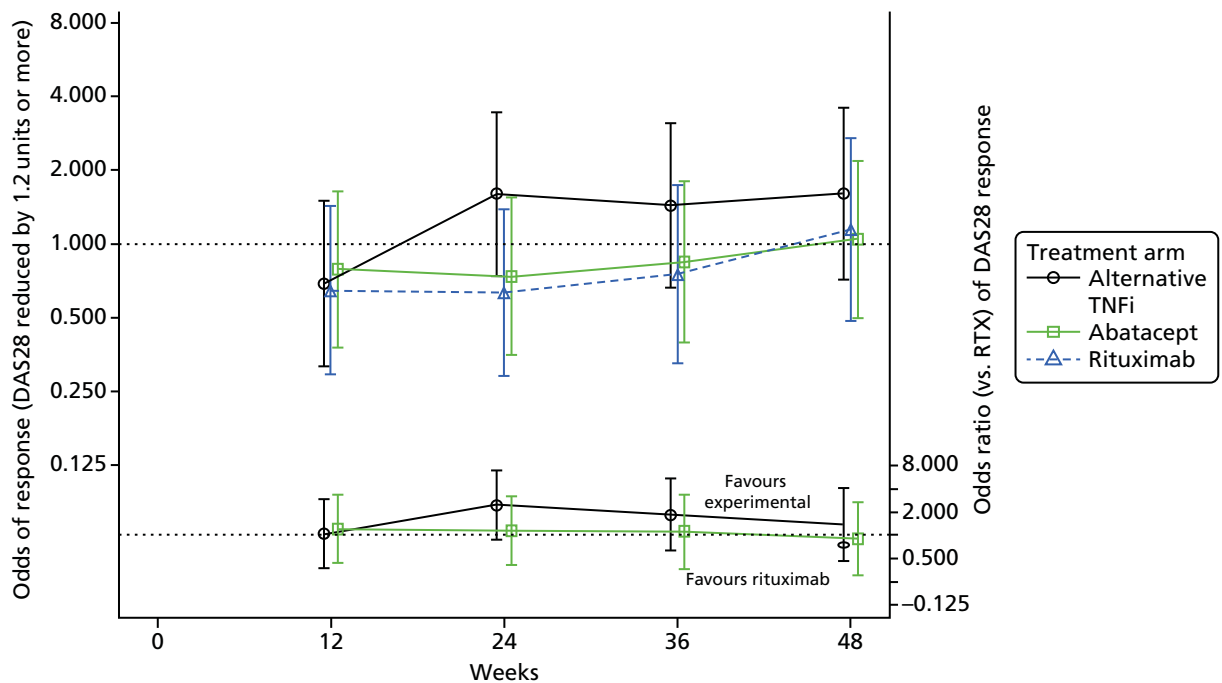

**FIGURE 10** Adjusted odds of achieving a DAS28 response and odds ratios of a response over 48 weeks. Covariance pattern model of a DAS28 response over time. Unstructured covariance pattern. Random centre effect excluded, baseline score adjusted. Estimated odds of achieving a DAS28 response at follow-up (top, left axis). Odds ratios of response of alternative TNFi and abatacept to rituximab at each time point (bottom, right axis).

There was no evidence of a treatment effect for either alternative TNFi or abatacept compared with rituximab after adjusting for the minimisation factors and baseline covariates, at any of the time points (see *Table 17*).

### American College of Rheumatology 20 response at week 24

*Table 18* provides the parameter estimates for the model and *Table 19* provides the adjusted odds ratios for achieving ACR20 response at 24 weeks post randomisation. *Figure 11* provides a graphical representation of the fitted values from the model.

There was no evidence of a difference in the odds of achieving an ACR20 response at 24 weeks post randomisation in either intervention compared with rituximab (OR 2.06, 95% CI 0.77 to 5.53 and OR 1.19, 95% CI 0.44 to 3.21 for alternative TNFi and abatacept, respectively).

Summaries of the missing values for the component end points of the ACR20 by treatment group are presented in *Appendix 13, Tables 69 and 70*.

### Additional secondary outcomes

#### Clinical assessment of disease activity over 48 weeks

*Appendix 12, Tables 54 and 57–65*, summarise measures of disease activity over 48 weeks by randomised treatment group. Summary statistics for each of the secondary outcomes over the observational period (weeks 60–96) are provided in *Appendix 12, Tables 58–65*. A brief description of the findings is given below. There were too few patients to make firm inferences from any of these analyses.

**TABLE 18** Multivariable logistic regression model for the ACR20 response at 24 weeks post randomisation: ITT patient population

Parameter	Odds ratio	95% CI	p-value
Intercept			0.062
Randomised treatment			
Alternative TNFi vs. rituximab	2.06	0.77 to 5.53	0.150
Abatacept vs. rituximab	1.19	0.44 to 3.21	0.736
RF/ACPA status: both seronegative vs. either seropositive	1.39	0.48 to 3.99	0.539
Disease duration: ≥ 5 years vs. < 5 years	1.73	0.73 to 4.12	0.216
Non-responder type: secondary vs. primary	0.55	0.24 to 1.26	0.161

**TABLE 19** Adjusted odds of an ACR20 response at 24 weeks post randomisation: ITT patient population

Treatment group	Adjusted odds ratio of response (95% CI)	Adjusted odds ratio of response vs. rituximab (95% CI)	p-value
Rituximab	0.43 (0.20 to 0.94)		
Abatacept	0.51 (0.24 to 1.08)	1.19 (0.44 to 3.21)	0.736
Alternative TNFi	0.89 (0.41 to 1.96)	2.06 (0.77 to 5.53)	0.150

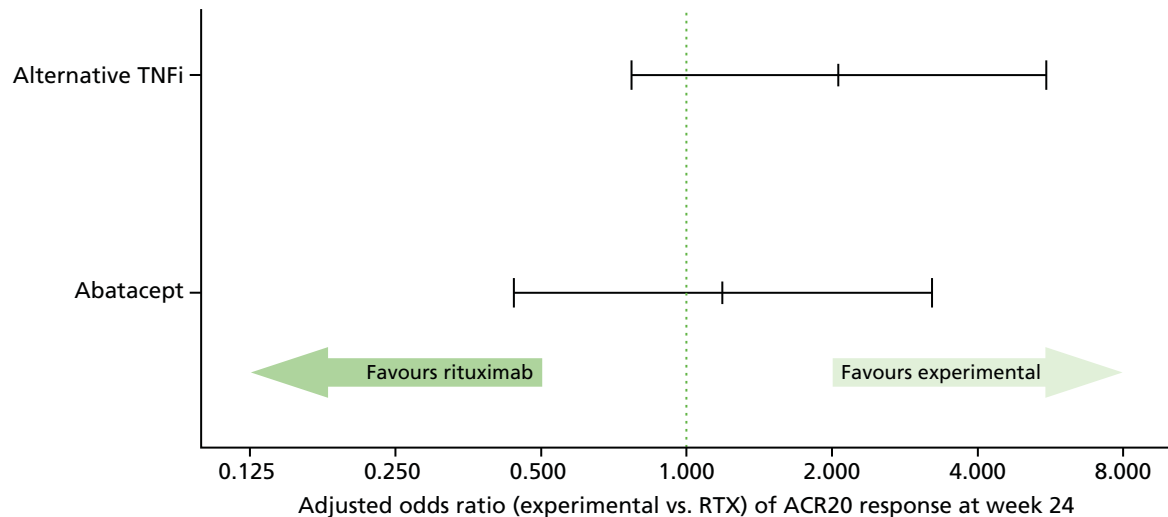

**FIGURE 11** Odds ratios of an ACR20 response relative to rituximab at 24 weeks post randomisation: ITT patient population.

### ***American College of Rheumatology 20, American College of Rheumatology 50 and American College of Rheumatology 70 response***

The proportion of patients on alternative TNFi who achieved an ACR20 response appeared to increase over time, reaching 54.8% by week 48, although, among patients on abatacept, the proportion decreased to 35.5% by week 48 and, among those on rituximab, it had increased by week 48 to 42.9% after an initial reduction at week 24 (27.0%), potentially reflecting the need for a repeat cycle of rituximab in the second 6-month period. The proportion of patients achieving an ACR50 response generally increased over time on alternative TNFi and rituximab and plateaued after week 24 for abatacept. The proportion of patients achieving an ACR70 fluctuated over time across all three treatment groups; overall, only 11.8% achieved an ACR70 by week 48 (see *Appendix 12, Table 57*).

### ***Disease Activity Score of 28 joints and Disease Activity Score of 28 joints response category***

The mean reduction in the DAS28 over 48 weeks was greater among patients on alternative TNFi than among those on rituximab, whereas a similar mean reduction in the DAS28 was apparent in the abatacept and rituximab groups [alternative TNFi mean at 48 weeks, 1.6 units (SD 1.64 units); abatacept mean at 48 weeks, 1.4 units (SD 1.38 units); and rituximab mean at 48 weeks, 1.2 units (SD 1.49 units)] (see *Appendix 12, Table 58*).

The proportion of patients who achieved DAS28 low disease activity or remission at 24 weeks was similar in the alternative TNFi and rituximab groups, but lower in the abatacept group (19.5%, 20.0% and 14.6%, respectively). The proportion of patients achieving remission at week 24 showed a similar pattern (alternative TNFi, 9.8%; rituximab, 10.0%; abatacept, 7.3%). Furthermore, in the alternative TNFi group, this figure continued to increase, reaching 26.8% by week 48; in contrast, in the abatacept and rituximab groups, it fell, to 7.3% and 7.5%, respectively (see *Appendix 12, Table 59*). The proportion of patients reaching remission at week 48 showed a corresponding increase in the alternative TNFi group (12.2%), but in the abatacept and rituximab groups, this fell to 4.9% and 5.0%, respectively.

### ***European League Against Rheumatism response***

The proportion of patients with a good EULAR response at 24 weeks was similar in the alternative TNFi and rituximab groups, at 19.5% and 17.5%, respectively, but was lower in the abatacept group, at 12.2%. Furthermore, in the alternative TNFi group, the proportion of patients achieving a good response generally increased over time, reaching 26.8% at week 48, whereas in the abatacept and rituximab groups, a reduction to 4.9% and 5.0%, respectively, was observed (see *Appendix 12, Table 60*).



### American College of Rheumatology/Boolean remission

A minority of patients achieved ACR/Boolean remission status over the 48 weeks. At 24 weeks, two patients (4.9%) on alternative TNFi and one patient (2.4%) on abatacept reached ACR/Boolean remission, compared with none on rituximab. By week 48 the frequency remained very low, with only one patient (2.4%) on alternative TNFi and a further one patient (2.4%) on abatacept reaching this status (see *Appendix 12, Table 61*).

### Clinical Disease Activity Index

Similar improvements over 48 weeks were observed in CDAI in the alternative TNFi and rituximab groups,, with a lower improvement observed in the abatacept group [median improvement of 19.3 (quartiles 5.7 and 28.8), 20.3 (quartiles 5.3 and 32.3) and 14.1 (quartiles 5.9 and 29.2) respectively] (see *Appendix 12, Table 62*).

### Simplified Disease Activity Index

Like the CDAI, improvement in the SDAI over 48 weeks was similar in the alternative TNFi and rituximab groups, but lower in the abatacept group [median improvement of 20.1 (quartiles 7.9 and 27.2), 20.1 (quartiles 5.3 and 34.0) and 13.7 (quartiles 6.3 and 31.2) respectively] (see *Appendix 12, Table 64*).

### Patient-reported outcomes over 48 weeks

*Figures 12–15* summarise the patient-reported outcomes of the HAQ-DI, RAQoL and HADS and *Figures 16–18* summarise the Patient Global Assessment of Pain, Patient Global Assessment of Arthritis and Patient Assessment of General Health VAS scores over 48 weeks by treatment group. Further summaries over the 96 weeks are provided in *Appendix 12, Tables 66 and 67*.

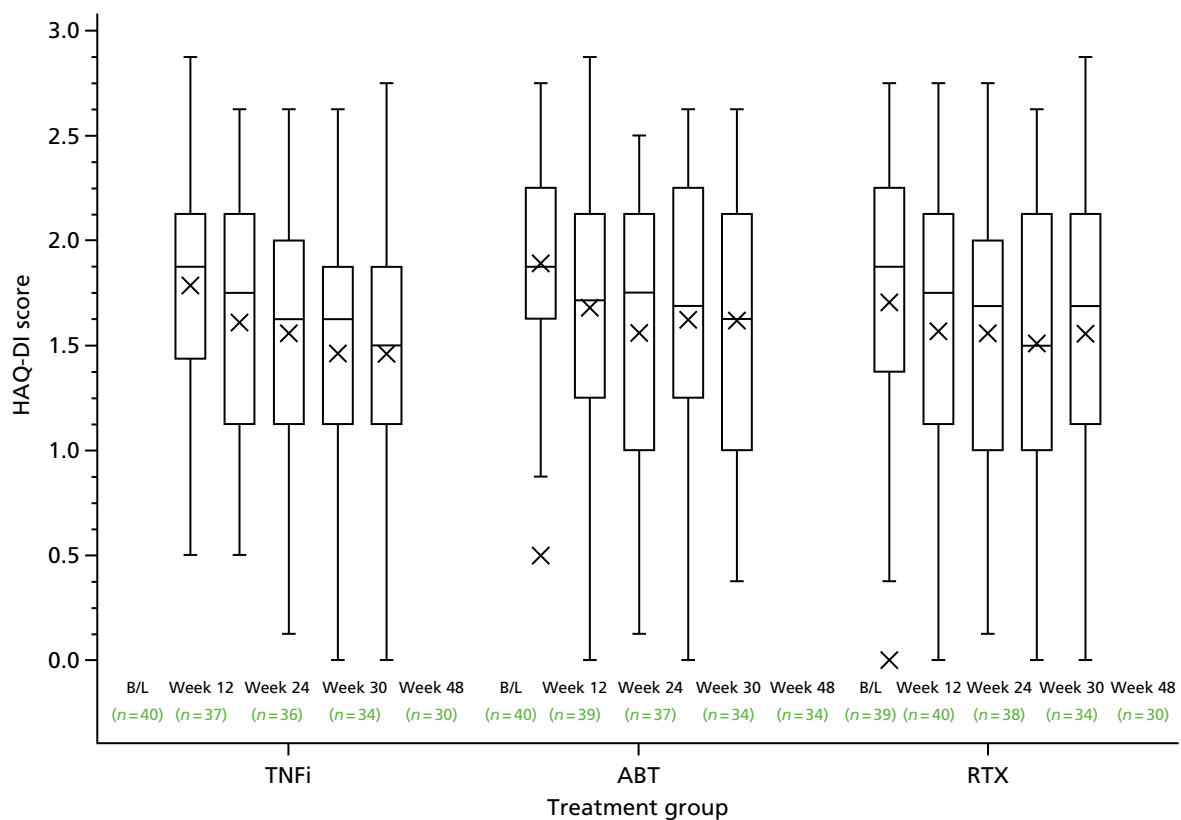

**FIGURE 12** Box and whisker plot: HAQ-DI score over 48 weeks by treatment group. X inside the bars corresponds to the mean value; X outside the bars corresponds to outlier values. B/L, baseline.

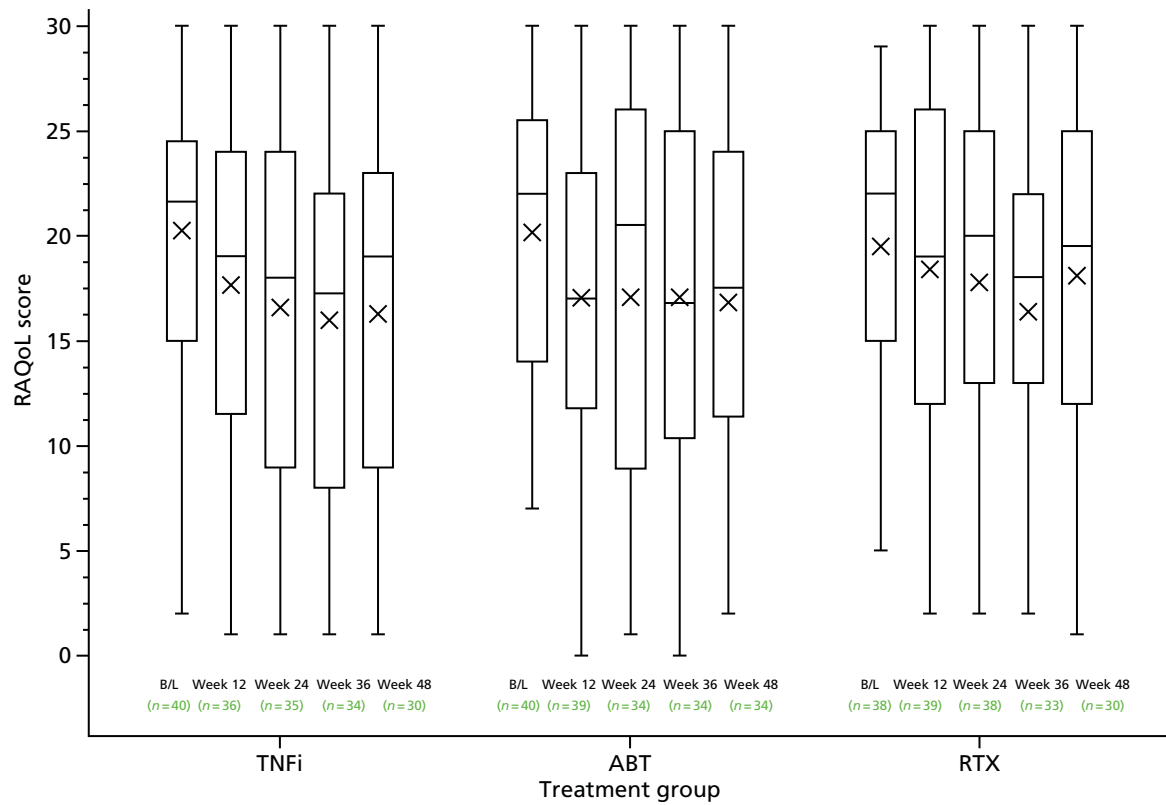

**FIGURE 13** Box and whisker plot: RAQoL over 48 weeks by treatment group. X inside the bars corresponds to the mean value; X outside the bars corresponds to outlier values. B/L, baseline.

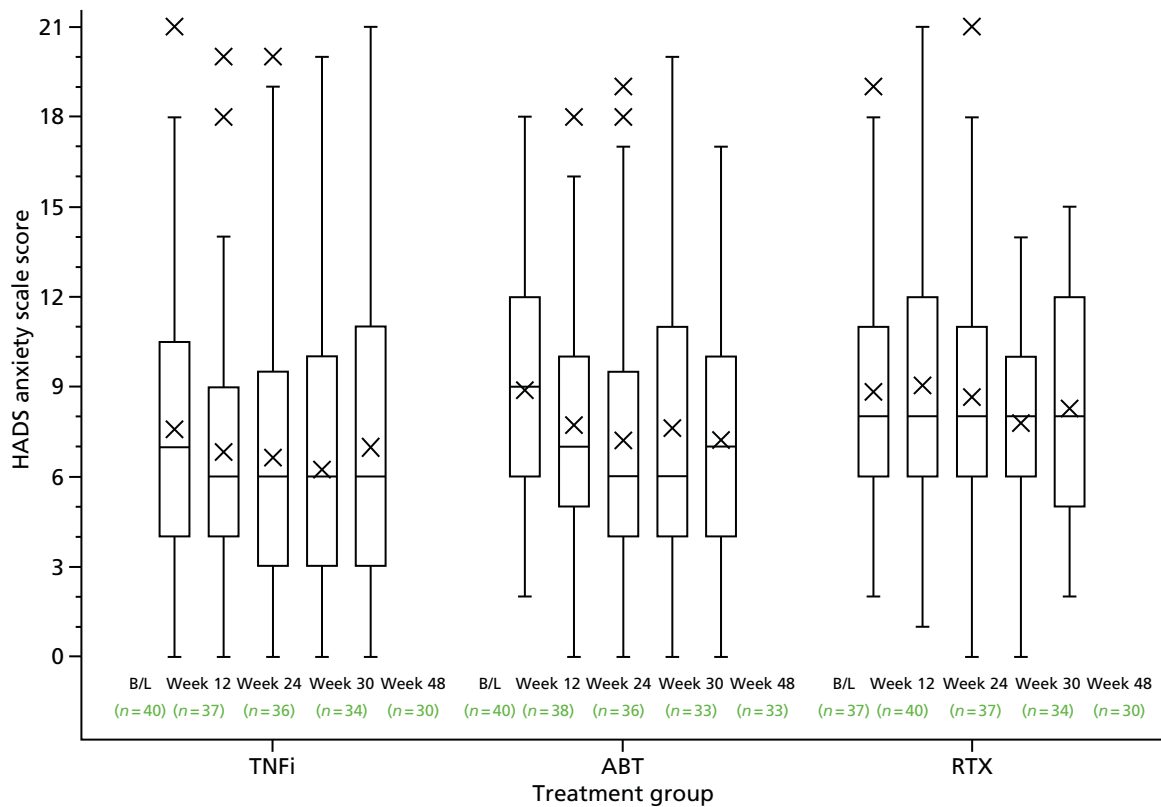

**FIGURE 14** Box and whisker plot: HADS anxiety scale over 48 weeks by treatment group. X inside the bars corresponds to the mean value; X outside the bars corresponds to outlier values. B/L, baseline.

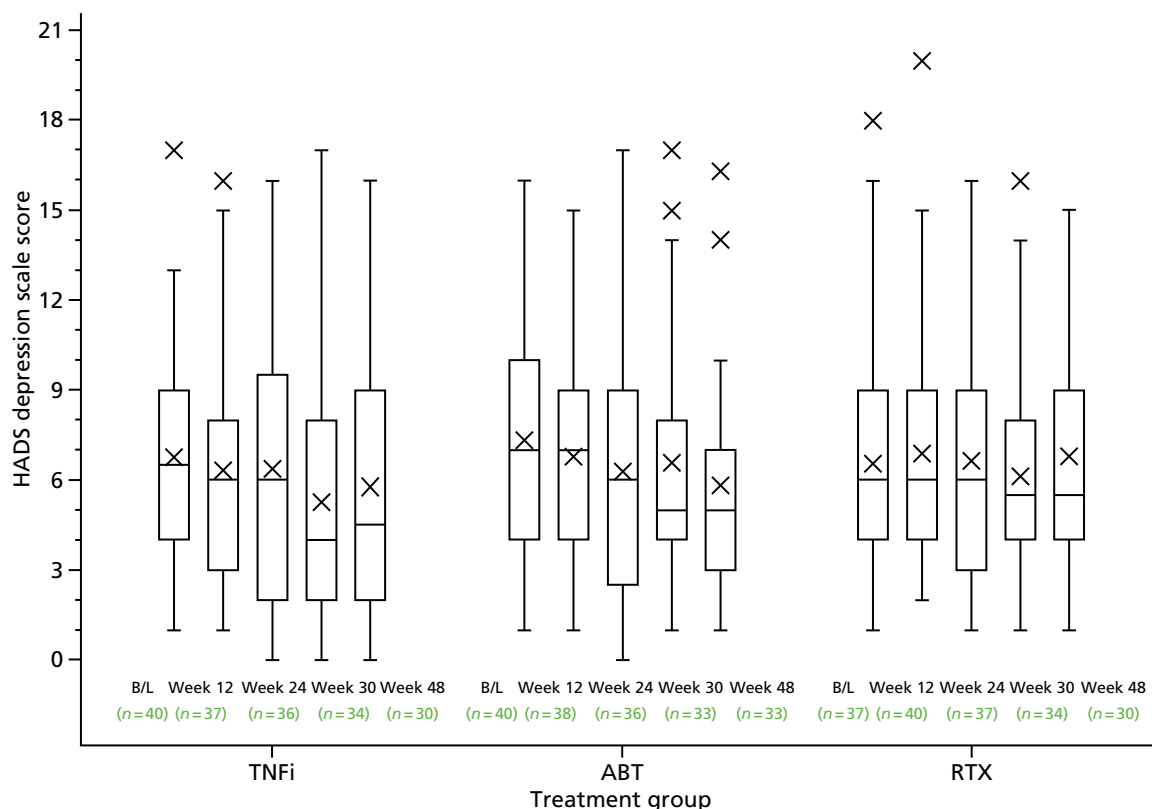

**FIGURE 15** Box and whisker plot: HADS depression scale over 48 weeks by treatment group. X inside the bars corresponds to the mean value; X outside the bars corresponds to outlier values. B/L, baseline.

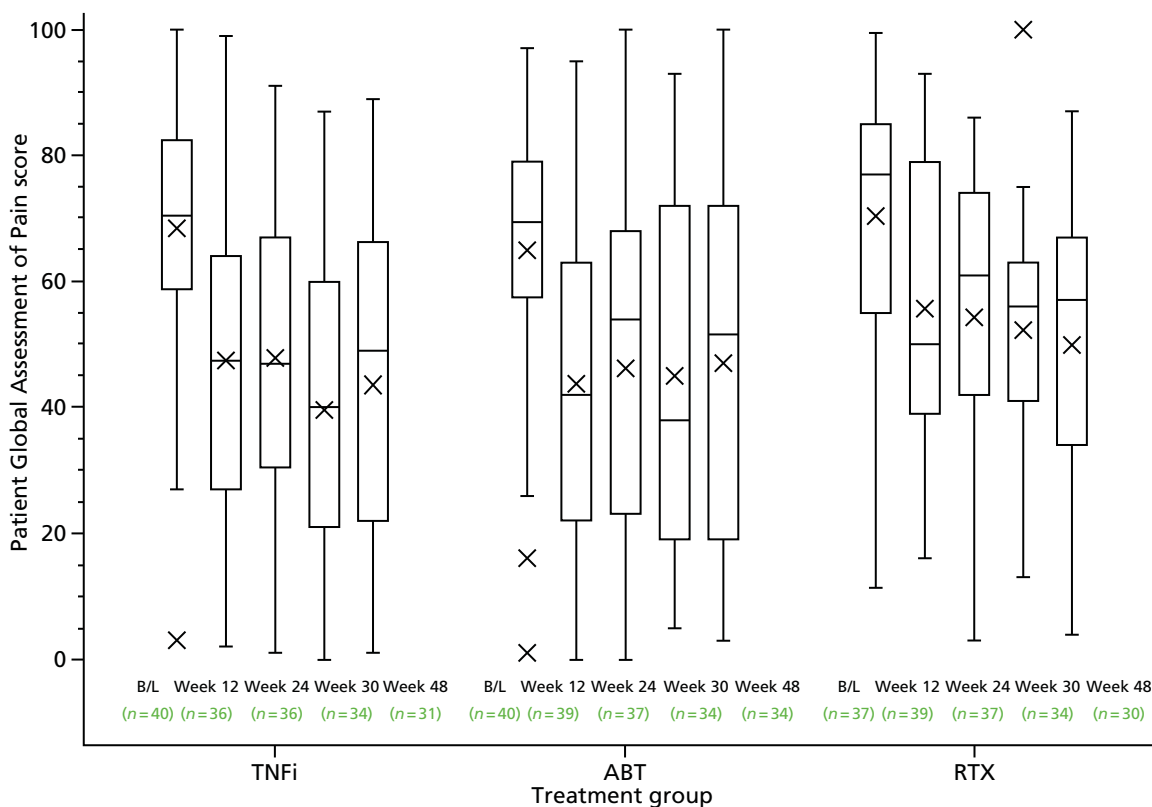

**FIGURE 16** Box and whisker plot: Patient Global Assessment of Pain over 48 weeks by treatment group. X inside the bars corresponds to the mean value; X outside the bars corresponds to outlier values. B/L, baseline.

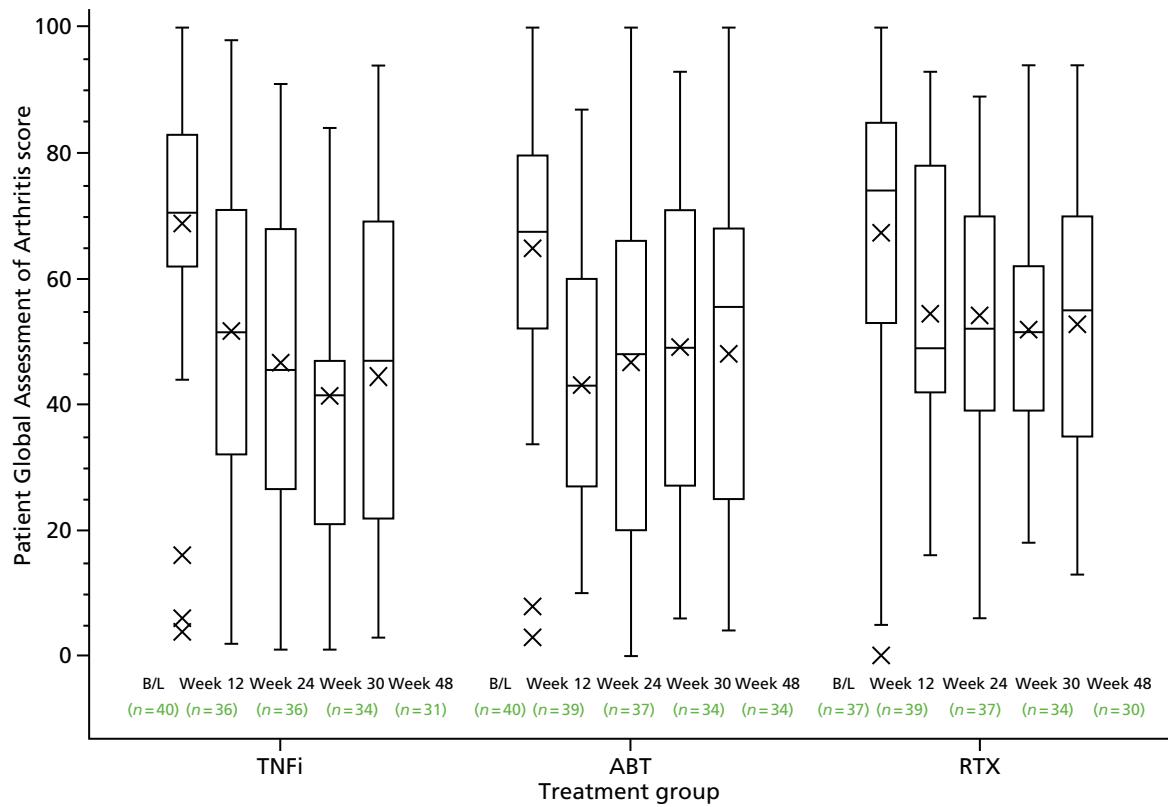

**FIGURE 17** Box and whisker plot: Patient Global Assessment of Arthritis over 48 weeks by treatment group. X inside the bars corresponds to the mean value; X outside the bars corresponds to outlier values. B/L, baseline.

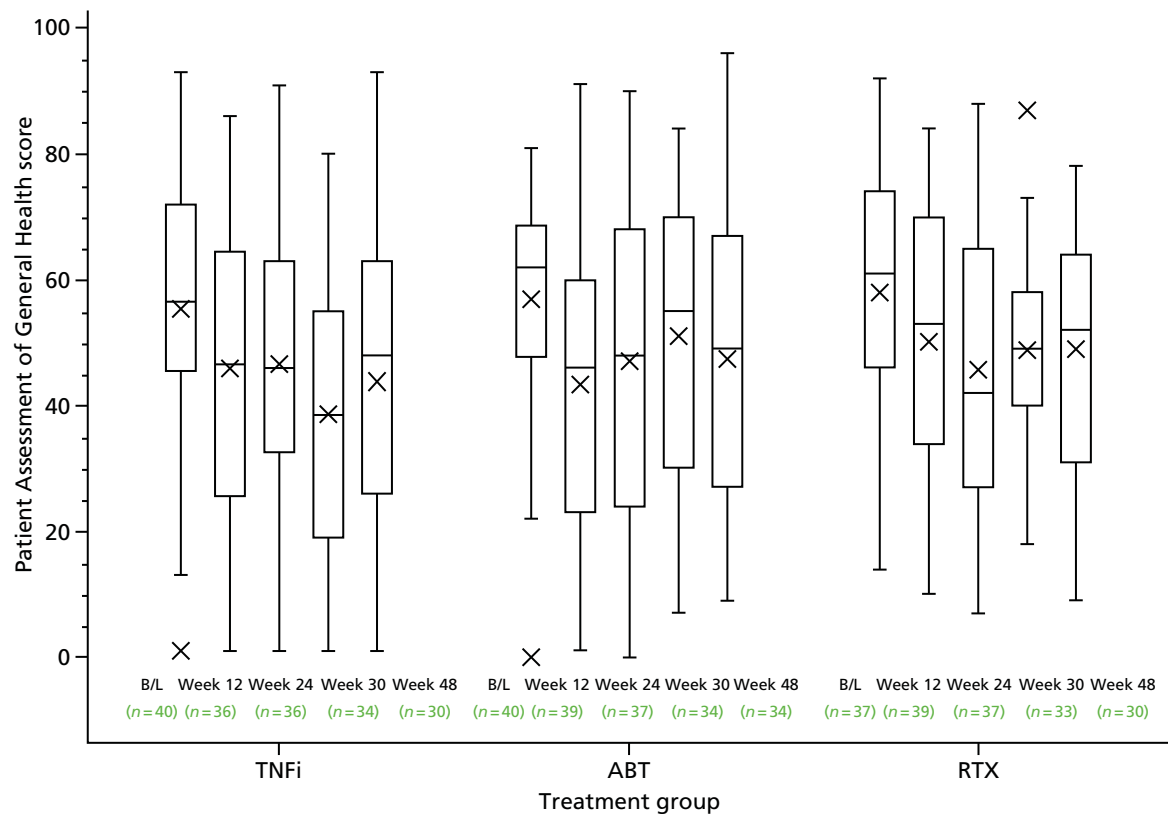

**FIGURE 18** Box and whisker plot: Patient Assessment of General Health over 48 weeks by treatment group. X inside the bars corresponds to the mean value; X outside the bars corresponds to outlier values. B/L, baseline.

### ***Health Assessment Questionnaire Disability Index, Rheumatoid Arthritis Quality of Life and Hospital Anxiety and Depression Scale***

Overall, there was an improvement in the HAQ-DI over the 48-week period across all three treatment groups. The median HAQ-DI score decreased to 1.5 (quartiles 1.1 and 1.9) in the alternative TNFi group, to 1.6 (quartiles 1.0 and 2.1) in abatacept group and to 1.7 (quartiles 1.1 and 2.1) the rituximab group (see *Figure 12*). Similarly, a general improvement in the RAQoL was observed over time, with no notable differences between treatment groups [median score of 19.0 (quartiles 9.0 and 23.0) was reported at 48 weeks in the alternative TNFi group, 17.5 (quartiles 11.4 and 24.0) in the abatacept group and 19.5 (quartiles 12.0 and 25.0) in the rituximab group] (see *Figure 13*). Small improvements in the HADS scores over the 48-week period were observed in the alternative TNFi and abatacept groups [median scores for anxiety and depression of 6 (quartiles 3.0 and 11.0) and 4.5 (quartiles 2.0, 9.0), respectively, in the alternative TNFi group and of 7.0 (quartiles 4.0 and 10.0) and 5.0 (quartiles 3.0 and 7.0), respectively, in the abatacept group], whereas no notable improvement was apparent in the rituximab group [median scores of 8.0 (quartiles 5.0 and 12.0) and 5.5 (quartiles 4.0 and 9.0), respectively] (see *Figures 14 and 15*).

### ***Patients' global assessment of pain, arthritis and general health***

A marked improvement in the patients' global assessments of pain was apparent in all three treatment groups by 12 weeks post randomisation; thereafter small fluctuations in median pain scores over time were observed (see *Figure 16*). The median pain VAS scores at 48 weeks were 49.0 (quartiles 22.0 and 66.0), 51.5 (quartiles 19.0 and 72.0) and 57.0 (quartiles 34.0 and 67.0) in the alternative TNFi, abatacept and rituximab groups, respectively; the observed higher median score for rituximab may in part be explained by the higher median score observed at baseline.

Similarly, an initial marked improvement in the patients' global assessment of their arthritis by 12 weeks post randomisation was apparent across all three treatment groups (see *Figure 17*). In the alternative TNFi arm, this improvement continued to 36 weeks, followed by a slight deterioration by 48 weeks [median 47.0 (quartiles 22.0 and 69.0)]. In comparison, following the initial 12-week improvement, in the abatacept and rituximab groups there was a slight deterioration in patients' global assessment of their arthritis by 48 weeks [median 55.5 (quartiles 25.0 and 68.0) and 55.0 (quartiles 35.0 and 70.0), respectively].

Overall, an improvement in patients' general health was observed over time, with no notable difference between treatment groups; the median score at 48 weeks was 48.0 (quartiles 26.0 and 63.0), 49.0 (quartiles 27.0 and 67.0) and 52.0 (quartiles 31.0 and, 64.0) in the alternative TNFi, abatacept and rituximab groups, respectively (see *Figure 18*).

### **Bone densitometry**

A total of 33 (60.0%) patients in the centres that had the facilities underwent a bone densitometry scan at their baseline assessment, with 14 (25.5%) patients undergoing scans at the week 48 assessment. *Appendix 12, Table 68*, presents the densitometry scores at baseline and 48 weeks for the subgroup of patients.

## **Safety**

### ***Serious adverse events***

A full listing of the SAEs and SSARs is included in *Appendix 14, Tables 71–74*. Ten SAEs were reported in nine patients. Of these, three events in three patients were considered to be related to trial medications and classed as SSARs. There were no suspected unexpected serious adverse reactions (SUSARs).

One patient in the TNFi arm, receiving infliximab, had a SSAR of autoimmune hepatitis but recovered with sequelae. Two patients who received abatacept experienced SSARs (one experienced angioedema and recovered and one contracted pneumonia and died) and a further two patients who received abatacept experienced SAEs (one experienced chest pain/epigastric pain, which remained unresolved, and one

contracted a chest infection but recovered). Finally, three patients who received rituximab each experienced a SAE: one patient developed malignant melanoma and subsequently died; one suffered a broken coccyx bone, attributable to collapsing, but recovered with sequelae, and a third experienced abdominal pain, but later recovered. A further patient who was randomised to receive rituximab experienced two SAEs occurring prior to first infusion: a flare of RA and left basal pneumonia, from both of which the patient recovered.

As summarised above, two patients died following the development of a SAE. One patient receiving rituximab had developed malignant melanoma, while a second patient developed pneumonia, considered by the treating physicians to be related to abatacept treatment, as well as another illness.

No pregnancies were reported in any of the trial patients or in any partners of the trial patients.

**Adverse events**

Overall, 243 non-SAEs were reported in 90 patients (*Table 20*). Twelve events resulted in a permanent cessation of treatment. *Table 20* summarises the number of non-SAEs reported by treatment received. A listing of all AEs is provided in *Appendix 14, Table 75*.

A total of 10 patients experienced one or more AE or SAE that resulted in a permanent cessation of treatment: four patients on alternative TNFi (9.8%), two on abatacept (4.9%) and four on rituximab (10.0%).

**TABLE 20** Frequency of non-SAEs reported by treatment group

AEs	Treatment arm			Total
	Alternative TNFi	Abatacept	Rituximab	
Number of patients with one or more AE	28	31	31	90
Number of AEs reported	83	73	87	243
Number of AEs per patient				
Mean (SD)	2.1 (2.27)	1.8 (1.68)	2.2 (2.17)	2.0 (2.04)
Median (IQR)	1.0 (0–3)	1.0 (1–3)	2.0 (1–3)	1.0 (0–3)
Range	0–8	0–6	0–8	0–8

IQR, interquartile range.

# Chapter 4 Health economic analysis

## Introduction

As described in *Chapter 1*, DMARDs are used in the early stages of management of RA. However, even when there is an initial positive response, treatment efficacy often reduces over time. bDMARDs are usually given to patients experiencing insufficient response to conventional DMARDs, but at a markedly higher cost of around £9500 per patient per year, compared with around £450 per year for conventional therapy.<sup>122</sup> During 2007–8, expenditure on bDMARDs for the treatment of RA alone ranged between £0.8M and £3.5M per acute trust, with expenditure on bDMARDs accounting for the highest pharmaceutical spend within some trusts.<sup>122</sup>

Tumour necrosis factor inhibitor drugs are a type of bDMARD that have been found to be costly but highly effective.<sup>31–33</sup> However, NICE currently approves only rituximab following TNFi non-response, with the use of alternative TNFi being permitted only when rituximab (and/or MTX that is co-prescribed) is contraindicated.

An economic evaluation was conducted to estimate the cost-effectiveness of alternative TNFi or abatacept compared with the current practice of rituximab in patients with RA who have failed treatment with an initial TNFi. The economic evaluation was conducted alongside the SWITCH clinical trial so that only the data collected within the (reduced) trial were analysed. Originally, the health economic analysis included a within-trial analysis and a decision analytical model. Given the early termination of the trial and the consequent reduced period of follow-up, the health economic analysis was adapted to include a within-trial cost-effectiveness analysis over 48 weeks and a value of information analysis to inform future research.

## Methods

### *Aim and end points*

The primary aim of this analysis was to assess the cost-effectiveness of the use of abatacept or alternative TNFi compared with the current practice of rituximab in patients with RA who have failed treatment with an initial TNFi. The primary end point was the cost per quality-adjusted life-year (QALY) gained. The methods used for this within-trial analysis were guided by the recommendations from the NICE methods guide.<sup>123</sup>

### *Perspective and time frame*

The study adopted a NHS and Public Social Services perspective for cost evaluation, but a broader societal perspective was adopted for secondary analysis to incorporate costs to patients and productivity costs. Costs and benefits for the base-case analysis were calculated for the study period of 48 weeks. As the time frame of the trial was < 1 year, discounting of the costs and benefits was not required.

### *Measurement of effectiveness*

This analysis used the QALY as the main outcome measure. QALYs are a generic measure of health state that take account of both quality and length of life such that 1 QALY is equal to 1 year in full health.<sup>124</sup>

Health-related quality of life was measured using the EuroQol 5 Dimensions, 3 levels (EQ-5D-3L). The EuroQol 5 Dimensions (EQ-5D) is a commonly used generic measure of health-related quality of life and is NICE's preferred outcome measure for cost-effectiveness analyses.<sup>123</sup> The questionnaire comprises five domains: mobility, self-care, usual activities, pain/discomfort and anxiety/depression. Each domain consists of three levels: no problems, some problems and severe problems.<sup>125</sup>

The EQ-5D-3L was administered at baseline and at follow-up visits in weeks 12, 24, 36 and 48. Responses were converted to health state utility values using the UK general population time trade-off tariff values.<sup>126</sup>

### Measurement of costs

Health-care resource utilisation data were collected using patient self-reported questionnaires covering primary care [e.g. general practitioner (GP) and nurse visits] and secondary care (e.g. hospital stays/visits) resource use over the trial period (see *Appendix 2*). The questionnaires also captured personal costs to patients related to RA (e.g. travel to/from hospital and cost of aids) and any impact the disease had on their income over the trial period. The resource-use questionnaires were completed at weeks 12, 24, 36 and 48 by the research teams at the participating centres and were supplemented by case report forms (CRFs) capturing data on hospital inpatient or outpatient visits. When there were discrepancies between the CRFs and the patient-completed forms, the CRFs were given precedence. Unit costs for health service staff and resources were obtained from the Personal Social Services Research Unit (PSSRU) report in 2015, entitled *Unit Costs of Health and Social Care 2015*,<sup>127</sup> and *NHS Reference Costs 2014 to 2015*.<sup>128</sup> For medications, a unit cost per treatment received was assigned. The Commercial Medicines Unit's electronic market Information Tool (eMit) was used to cost the drugs when possible.<sup>129</sup> However, when drugs were not listed on eMit, costs were taken from the *British National Formulary (BNF)*.<sup>130</sup> When unit costs were not available, targeted literature searches were used to provide the relevant costs which were inflated to 2015 prices (pounds sterling) using an online inflator.<sup>131</sup> Unit costs are presented in *Appendix 15, Table 76*.

### Assumptions related to medication use

A number of assumptions were required in order to measure the costs related to the drugs used within the trial:

- When the patient's weight was needed to calculate the dose of trial medication, the baseline weight was used. This applied to the one patient using infliximab and, in this case, the associated cost was not affected if the patient's weight at each clinical assessment had been used instead.

As no stop date was recorded for the trial drugs, the number of doses was deduced from the CRFs making the following assumptions.

1. If the records showed that all infusions were received as per the protocol, the full protocol-defined allocation for the relevant time period was allocated to that patient.
2. In patients who were reported to have received some randomised treatment but the infusions received did not follow protocol because they were delayed, it was assumed that the patient received the full allocation of trial medication.
3. In patients who were reported to have received some randomised treatment but for whom infusions received did not follow protocol because treatment was stopped, it was assumed that the patient received half the allocation of trial medication for that time period.
4. If it was indicated that some of the randomised treatment had been received but it was not reported whether or not all the treatment had been received or whether or not there had been any modifications to the treatment protocol, it was assumed that the full allocation of treatment for that time period had been received.
5. For treatments administered by injection, if the number of missing injections was recorded, the number of missing injections was taken from the full protocol-defined allocation for the relevant time period.
6. For treatments administered by injection, if some treatments were missed but the number of treatments missed was not recorded, then it was assumed that half of the allocation for the relevant time period was received.



The following assumptions were applied in order to cost the concomitant drugs used within the trial period.

- When dose was not recorded, it was assumed that the standard dose was received.
- When it was indicated that it was an ongoing drug with no start or end date recorded, it was assumed that it was taken for the full 48 weeks.
- For those patients who took MTX, it was assumed that it was taken orally at an average dose of 15 mg per week based on the relevant literature and expert opinion.<sup>132</sup>

### Missing data

The base-case analysis was conducted using only complete cases. That is, patients were included in the analysis if they had no missing resource use data as well as no missing quality-of-life data. In the case of resource use, no missing data were defined as a resource use form having been completed at all time points. For the resource use questionnaires, if a patient recorded that they had used a form of health care (e.g. GP visit) but did not record the number of visits, the mean number of visits was imputed. For quality of life, complete data were defined as a completed quality-of-life questionnaire returned at each time point.

Sensitivity analyses were conducted using imputed data so that all patients were included in the analysis. Two imputation methods were explored: mean imputation and multiple imputation. For the mean imputation, when a QALY value for a given time point was missing, the mean of the non-missing QALYs for the trial arm at that time point was imputed. The same approach was taken to impute missing cost data for resource use. For the multiple imputation, costs for each follow-up and total QALYs were imputed by chained equations using predictive mean matching.<sup>133</sup> Forty-five data sets were imputed (reflecting the percentage of incomplete cases), which were then combined using Rubin's rules.<sup>119,134</sup>

### Analysis

The primary analysis was a cost-effectiveness analysis of the three relevant treatment arms of the trial. A complete-case analysis was the primary method for analysing the trial data and an ITT analysis was undertaken as a sensitivity analysis.

Resource use and costs were quantified and analysed using analysis of variance and independent sample *t*-tests. Owing to the small sample size and, subsequently, the potential violation of the underlying normality assumption when using *t*-tests, the robustness of the results was checked using a non-parametric bootstrap.

Health-state utilities were used to calculate QALYs using an area under the curve approach:

$$\begin{aligned} \text{QALY} = & \{[(\text{EQ-5D}_{\text{Baseline}} + \text{EQ-5D}_{12})/2] \times 0.231\} + \{[(\text{EQ-5D}_{12} + \text{EQ-5D}_{24})/2] \times 0.231\} \\ & + \{[(\text{EQ-5D}_{24} + \text{EQ-5D}_{36})/2] \times 0.231\} + \{[(\text{EQ-5D}_{36} + \text{EQ-5D}_{48})/2] \times 0.231\}, \end{aligned} \quad (6)$$

where EQ-5D<sub>Baseline</sub>, EQ-5D<sub>12</sub>, EQ-5D<sub>24</sub>, EQ-5D<sub>36</sub> and EQ-5D<sub>48</sub> are the EQ-5D scores at baseline, week 12, week 24, week 36 and week 48, respectively; 0.230769 represents 12 weeks out of 52 for each time period:

$$t = \frac{12}{52} = 0.230769 \quad (7)$$

Total costs and QALYs for each arm of the trial were calculated. For the secondary analysis, a wider cost perspective was adopted to include the total costs incurred by the patients.

Incremental cost-effectiveness ratios (ICERs) were calculated.<sup>135</sup> An ICER represents the additional cost per QALY gained for each intervention compared with the next best alternative and is calculated as follows for treatment A relative to treatment B:

$$\text{ICER} = (\text{Cost}_A - \text{Cost}_B)/(\text{QALY}_A - \text{QALY}_B), \quad (8)$$

where  $Cost_A$  and  $Cost_B$  are the mean costs and  $QALY_A$  and  $QALY_B$  are the mean QALYs for groups A and B. An intervention was judged to be cost-effective using the lower limit of the NICE acceptance threshold of £20,000 per incremental QALY ( $\lambda = £20,000$ ) as the decision rule for the analysis.<sup>123</sup>

The level of sampling uncertainty around the ICER was determined using non-parametric bootstrapping (with replacement) to generate 10,000 estimates of incremental costs and benefits. These were then plotted on the cost-effectiveness plane to visualise the uncertainty around the mean incremental costs and effects. The expected ICERs for the primary analysis were estimated from the means of bootstrapped cost and outcome distributions.

Net monetary benefit (NMB) values were also calculated. Net benefit (NB) combines cost-effectiveness and willingness to pay to give an explicit monetary valuation of the health outcome. It is calculated by rearranging the ICER calculation and incorporating a proposed willingness-to-pay threshold value per QALY.<sup>135</sup> The expected value of the NMB was calculated for each treatment. Treatments with positive NMBs provide more health benefit than is displaced by the associated opportunity costs and should be adopted. The treatment with the highest positive NMB is the most cost-effective.<sup>135</sup> The probability that the treatments were cost-effective was evaluated by generating estimates of NMB for a range of cost-effectiveness thresholds ( $\lambda$ ). This analysis was presented as a cost-effectiveness acceptability curve.<sup>136,137</sup> The cost-effectiveness acceptability curve provides decision-makers with useful information regarding the risk of making a wrong decision; however, the decision to fund or not fund a treatment should be made on the expected value of the NMB.

Net monetary benefit is derived for each patient as:

$$NMB = (\lambda \times QALYs) - \text{costs.} \quad (9)$$

### Sensitivity analyses

The following scenario sensitivity analyses were conducted to test the robustness of the conclusions drawn from the results.

1. Mean imputed data: an analysis was conducted using singly imputed data for missing QALYs and costs to enable an assessment of cost-effectiveness using data from all patients.
2. Multiple imputation: an analysis was conducted using multiply imputed data for missing QALYs and costs.
3. Adjust baseline: an analysis was conducted to evaluate the effect of adjusting for baseline differences in EQ-5D score (using an ordinary least squares regression and adjustment: total QALYs over 48 weeks were regressed on trial arm, EQ-5D score at baseline, age at baseline and sex).
4. Subcutaneous MTX: patients could have taken MTX orally or by subcutaneous injection but, as the method was not recorded, at baseline an assumption was made that MTX was taken orally by all patients. Therefore, sensitivity analysis was conducted that explored the alternative scenario that MTX was instead taken via subcutaneous injection by all patients.

Secondary analysis assessed the effect of taking a broader, societal cost perspective. The analysis uses health and social sector costs together with the addition of patient out-of-pocket costs plus values from the EQ-5D to estimate QALYs (replicating the primary analysis). As in the primary analysis the base case used complete cases. Sensitivity analyses using mean imputation and multiple imputation were undertaken.

### Value of information analysis

Value of information analysis was conducted to estimate the potential gains from the elimination of uncertainty as a result of conducting additional research. As decisions based on current information are uncertain (because of imperfect information) there is a chance that the wrong decision will be made, resulting in costs being incurred in the form of health benefit and cost of resources forgone. Given the very small sample size, the decision uncertainty is large and, therefore, the value of information analysis is

especially important. The expected value of perfect information (EVPI) is derived from the expected costs associated with the uncertainty in decisions. The EVPI provides the maximum value that a health-care system should be willing to pay for additional evidence to eliminate uncertainty in parameter estimates to inform future decisions, and gives an upper bound for the value of additional research. As information is valuable to all patients with a disease (not just one patient) EVPI can be expressed for the population of patients who could benefit.<sup>138,139</sup> The EVPI was calculated for the population of the UK who have RA as follows:

$$EVPI = E_{\theta} \max_j NB(j, \theta) - \max_j E_{\theta} NB(j, \theta). \quad (10)$$

The bootstrap simulation provides estimates of costs and benefits and, therefore, NB.  $E_{\theta} \max_j NB(j, \theta)$  is the expected NB with perfect information, which is the mean value of NMB in the set when the intervention with the higher NMB is chosen for each simulation, and  $\max_j E_{\theta} NB(j, \theta)$  is the expected NB with current information, which is obtained when the intervention with the higher expected NB is chosen across all simulations.<sup>140</sup>

All of the analyses were conducted in Stata® (version 14, StataCorp LP, College Station, TX, USA) and Microsoft Excel® (2013, Microsoft Corporation, Redmond, WA, USA).

## Results

### Sample

Of the 122 patients recruited to the trial, 70 patients with complete resource use data and EQ-5D results (25 rituximab, 24 abatacept and 21 alternative TNFi) were included in the base-case analysis.

Baseline characteristics of the 70 patients analysed in the complete case are presented in *Table 21* (see *Table 3* for baseline characteristics of the ITT population). In all treatment arms more than two-thirds of the patients were female. The average weight was slightly lower in the abatacept group than in the other treatment groups. Fewer patients in the alternative TNFi arm were non-smokers and a higher percentage were past smokers than in the other treatment arms. There was some variation between arms in baseline EQ-5D scores, with the alternative TNFi group having the highest scores. However, the difference between the scores was not statistically significant.

### Resource use and costs

*Table 22* shows the average resource use of patients with complete resource use data over the trial period in each trial arm (rituximab,  $n = 29$ ; abatacept,  $n = 26$ ; and alternative TNFi,  $n = 25$ ). Further breakdown of resource use is provided in *Appendix 15, Table 79*. Average health-care costs over the trial period are presented in *Table 23*. These are broken down further in *Appendix 15, Table 80*. The mean (SD) total costs of community health and social services were £927.17 (£1238.60) for the rituximab group, £601.20 (£553.70) for the abatacept group and £557.80 (£513.42) for the alternative TNFi group. The mean (SD) total costs for hospital and residential care services were £1112.71 (£1137.51) for the rituximab group, £862.61 (£788.43) for the abatacept group and £957.78 (£678.42) for the alternative TNFi group. All groups have large SDs for these costs, particularly rituximab, which are driven by the skewed distribution of costs, floor effects (zero costs for each cost component were observed for a proportion of patients) and by a number of high-cost outliers. This is shown in the box and whisker plots in *Figure 19*. It would be wrong to overinterpret differences between the groups given the outliers, skewness and small sample. Despite having the highest resource use cost, the rituximab treatment group incurred the lowest mean

**TABLE 21** Baseline characteristics of patients included in the complete-case analysis by treatment group

Patient characteristic	Treatment arm		
	Rituximab ( <i>n</i> = 25)	Abatacept ( <i>n</i> = 24)	Alternative TNFi ( <i>n</i> = 21)
Age (years)			
Mean (SD)	58.51 (11.55)	57.17 (13.90)	56.53 (9.31)
Sex, <i>n</i> (%)			
Male	7 (28)	1 (4)	5 (24)
Female	18 (72)	23 (96)	16 (76)
Weight (kg)			
Mean (SD)	85.26 (21.05)	75.86 (15.79)	81.91 (20.24)
Smoking status, <i>n</i> (%)			
Non-smoking	10 (40)	9 (37.5)	5 (23.8)
Past smoker	10 (40)	9 (37.5)	10 (47.6)
Current smoker	5 (20)	6 (25)	6 (28.6)
EQ-5D score			
Mean (SD)	0.31 (0.34)	0.39 (0.32)	0.46 (0.27)
DAS28			
Mean (SD)	6.14 (1.34)	6.23 (0.97)	5.77 (0.78)
Missing	3	3	0
HAQ score			
Mean (SD)	1.74 (0.84)	1.8 (0.59)	1.75 (0.5)
Missing	0	1	0

total NHS cost along the whole treatment pathway. The trial medication costs reported in *Table 23* include the cost of administering the drugs as well as the cost of the medication. The unit costs of the trial medication are reported in *Appendix 15, Table 77*, and a breakdown of the cost of administering each of the trial drugs is presented in *Appendix 15, Table 78*, for other relevant unit costs. As costs are assigned per treatment received, we note that there may be cases in which retreatment occurs within the trial period. In these cases, the costs for retreatment are included in the analysis but some of the benefits that may extend beyond the end of the trial could be excluded. This may be particularly relevant for rituximab, as 20 patients received re-infusion within the trial period.

Independent-sample *t*-tests were undertaken to explore differences in the mean total NHS costs associated with treatment groups. However, the *t*-test is based on the assumption that the data are normally distributed, which is violated, and asymptotic results surrounding normality of the mean costs are not robust because of the small sample size. Consequently, a non-parametric bootstrap of the difference in costs was conducted as a check on the robustness of the standard Student *t*-tests.<sup>124</sup> Independent-sample *t*-tests indicated that there was a significant difference in the mean total NHS costs associated with the rituximab treatment group and the abatacept treatment group ( $p = 0.0003$ ). There was also a significant difference between the mean costs for the alternative TNFi group and the abatacept group ( $p = 0.0002$ ), but there was no statistically significant difference between the mean costs associated with the rituximab group and the alternative TNFi group ( $p = 0.6772$ ). The bootstrap confirmed the results of the *t*-test.

**TABLE 22** Average resource use per patient over the trial period in each treatment group (complete resource use data)<sup>a</sup>

Resource use	Treatment arm								
	Rituximab (n = 29)			Abatacept (n = 26)			TNFi (n = 25)		
	Mean (SD)	Minimum	Maximum	Mean (SD)	Minimum	Maximum	Mean (SD)	Minimum	Maximum
<b>Community health and social services</b>									
GP surgery visit									
Face to face	9.10 (10.88)	0	43	6.19 (4.84)	0	23	6.32 (4.91)	0	15
Telephone/e-mail	2.34 (4.15)	0	19	0.57 (1.79)	0	9	1.44 (2.48)	0	10
GP home visit									
Face to face	0.24 (0.99)	0	5	0.07 (0.39)	0	2	0.04 (0.2)	0	1
District nurse									
Face to face	0.72 (1.87)	0	9	0.81 (1.55)	0	6	1.28 (2.30)	0	7
Telephone/e-mail	0.34 (0.19)	0	1	0.27 (0.96)	0	4	0.08 (0.4)	0	2
Social worker									
Face to face	0.10 (0.41)	0	2	0	0	0	0 (0)	0	0
Telephone/e-mail	0.07 (0.37)	0	1	0	0	0	0 (0)	0	0
Physiotherapist									
Face to face	3.14 (7.00)	0	30	2.88 (8.12)	0	40	1.36 (3.38)	0	14
Telephone/e-mail	0.41 (1.88)	0	10	0.04 (0.20)	0	1	0 (0)	0	0
Occupational therapist									
Face to face	0.41 (1.43)	0	6	0.54 (1.07)	0	4	0.32 (1.6)	0	8
Telephone/e-mail	0.07 (0.26)	0	2	0.04 (0.20)	0	1	0 (0)	0	0
Podiatrist									
Face to face	2.24 (4.28)	0	18	2.12 (4.10)	0	14	1.96 (4.21)	0	14
Telephone/e-mail	0.28 (1.16)	0	6	0 (0)	0	0	0 (0)	0	0

continued

**TABLE 22** Average resource use per patient over the trial period in each treatment group (complete resource use data)<sup>a</sup> (continued)

Resource use	Treatment arm								
	Rituximab (n = 29)			Abatacept (n = 26)			TNFi (n = 25)		
	Mean (SD)	Minimum	Maximum	Mean (SD)	Minimum	Maximum	Mean (SD)	Minimum	Maximum
Counsellor									
Face to face	0.31 (1.67)	0	9	0 (0)	0	0	0.24 (0.88)	0	4
Telephone/e-mail	0 (0)	0	0	0 (0)	0	0	0.16 (0.8)	0	4
Psychologist <sup>b</sup>									
Face to face	0.14 (0.74)	0	4	0 (0)	0	0	0 (0)	0	0
Home help <sup>b</sup>									
Face to face	3.72 (12.46)	0	48	0.46 (2.59)	0	12	0.48 (2.4)	0	12
<b>Hospital or residential care services</b>									
Hospital inpatient stay	0.79 (2.27)	0	10	0 (0)	0	0	0.08 (0.28)	0	1
Hospital outpatient clinic	3.48 (2.94)	0	12	4.15 (2.60)	0	8	4.76 (3.38)	0	16
Hospital day centre	1.76 (2.41)	0	8	1.08 (2.59)	0	10	1.2 (2.40)	0	9
Hospital accident and emergency department	0.34 (0.94)	0	4	0.19 (0.98)	0	5	0.4 (0.28)	0	7

a The table reports only the use of main services, and because there were no nursing home or residential home visits these are excluded from the table.

b There were no reported household help or psychologist contacts by telephone or e-mail.

**TABLE 23** Mean health-care costs by trial arm (complete cost data)

Health-care cost (£)	Treatment arm		
	Rituximab (n = 29)	Abatacept (n = 26)	TNFi (n = 25)
Community health and social services			
Mean (SD)	927.17 (1238.6)	601.2 (553.7)	557.8 (513.42)
Minimum	0	0	0
Maximum	5291.57	2388	1818.23
Hospital and residential care services			
Mean (SD)	1112.71 (1137.51)	862.61 (788.43)	957.78 (678.42)
Minimum	0	0	224
Maximum	5039.21	3322	2523
Trial medication <sup>a</sup>			
Mean (SD)	6633.49 (3197.01)	11,584.52 (4733.65)	6939.19 (2679.69)
Minimum	2024.96	1407.6	902.28
Maximum	16,199.68	15,015.6	9353.64
MTX			
Mean (SD)	32.36 (5.27)	30.92 (3.42)	35.14 (3.09)
Minimum	14.4	21.6	31.2
Maximum	38.4	33.6	45.6
Other concomitant medication			
Mean (SD)	396.78 (1830.36)	519.51 (1168.58)	807.93 (1909.68)
Minimum	0	0	0
Maximum	9907.84	3590.59	7014.68
Total NHS			
Mean (SD)	9102.51 (3375.77)	13,598.77 (4092.09)	9297.84 (2007.36)
Minimum	4716.78	2690.88	1462.19
Maximum	18,064.16	17,661.2	12,573.96
Patient costs			
Mean (SD)	1081.66 (2020.47)	387.79 (655.19)	947.07 (2521.82)
Minimum	0	0	0
Maximum	9028.5	2552	12676
Total all			
Mean (SD)	10,184.17 (3509.55)	13,986.55 (4382.28)	10,244.91 (3298.72)
Minimum	4874.25	2692.23	1462.19
Maximum	18,292.16	20,213.2	21,882.63

<sup>a</sup> Includes drug administration cost.

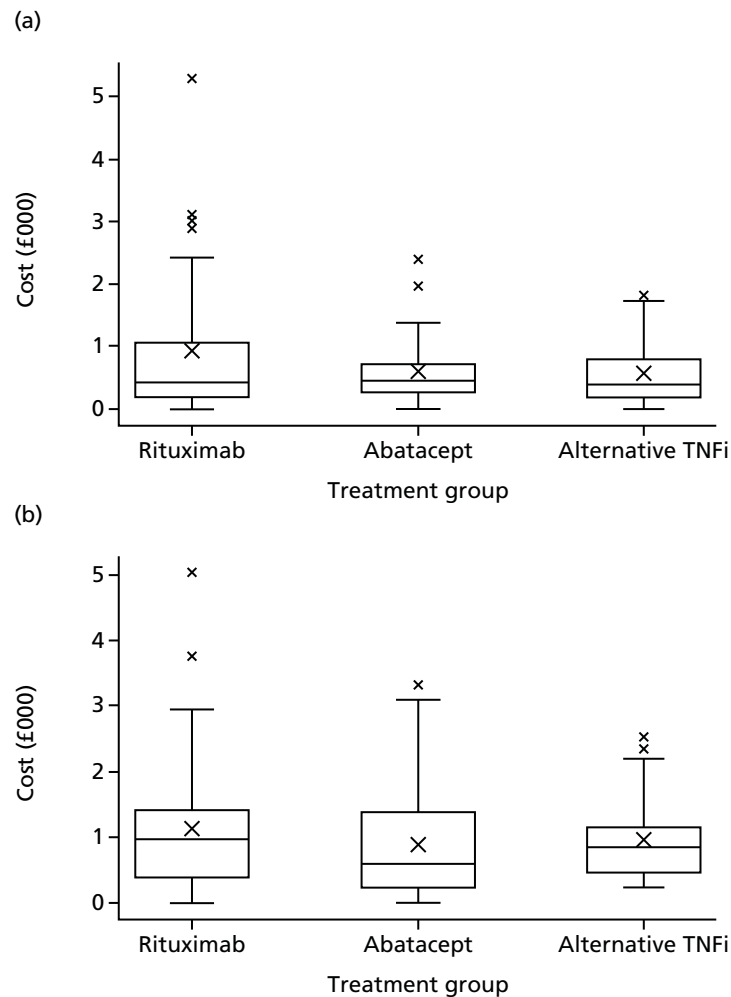

**FIGURE 19** Box and whisker plots of the distributions of the resource use costs by treatment group. (a) Total community health and social services cost and (b) total hospital and residential care services cost. X inside the bars corresponds to the mean value; and X outside the bars corresponds to outlier values.

### Quality-of-life data

The mean (SD) EQ-5D scores for each trial arm, at each time point, are presented in *Table 24*. There was an apparent increase in mean EQ-5D score from baseline to week 12 in all treatment groups. Although there were small fluctuations in scores, this initial improvement was more or less maintained up to week 48 in all arms of the trial. All three treatment groups show an increase in EQ-5D score from baseline to week 48. Despite the apparent slightly higher baseline EQ-5D score for the alternative TNFi group, statistical tests indicated that there was no statistically significant difference in EQ-5D scores at baseline ( $p = 0.2592$ ). This was explored further in a sensitivity analysis adjusting for baseline differences in EQ-5D score.

*Table 25* shows the mean EQ-5D change scores between baseline and each of the follow-up time points. Statistical analysis using analysis of variance indicated that the variation among groups in the changes in EQ-5D scores was not statistically significant ( $p = 0.7071$ ).

### Missing data

Seventy-four patients had complete EQ-5D scores across all time points. The remaining 48 had EQ-5D scores missing for at least one of the time periods. All 122 patients completed resource use questionnaires in the first two time periods (12 and 24 weeks), but the response rate dropped in the following two time periods to 98 forms returned (79%) at 36 weeks and 89 forms returned (71%) at 48 weeks.



**TABLE 24** Mean (SD) EQ-5D scores by treatment group and time point (complete outcome data)

Time point	Treatment arm		
	Rituximab	Abatacept	Alternative TNFi
Baseline			
Mean (SD)	0.36 (0.33)	0.34 (0.33)	0.42 (0.29)
<i>n</i> valid (missing)	37 (3)	36 (5)	40 (1)
Week 12			
Mean (SD)	0.51 (0.25)	0.52 (0.29)	0.59 (0.23)
<i>n</i> valid (missing)	38 (2)	39 (2)	37 (4)
Week 24			
Mean (SD)	0.48 (0.29)	0.55 (0.29)	0.57 (0.24)
<i>n</i> valid (missing)	36 (4)	37 (4)	33 (8)
Week 36			
Mean (SD)	0.52 (0.23)	0.54 (0.32)	0.59 (0.29)
<i>n</i> valid (missing)	34 (6)	33 (8)	33 (8)
Week 48			
Mean (SD)	0.51 (0.29)	0.50 (0.29)	0.55 (0.28)
<i>n</i> valid (missing)	30 (10)	33 (8)	29 (12)

**TABLE 25** Mean EQ-5D change from baseline to each follow-up time point for each trial arm

Time point	Treatment arm		
	Rituximab	Abatacept	Alternative TNFi
Baseline to week 12			
Mean (SD)	0.19 (0.33)	0.17 (0.32)	0.14 (0.25)
<i>n</i>	35	34	36
Baseline to week 24			
Mean (SD)	0.13 (0.37)	0.22 (0.32)	0.11 (0.29)
<i>n</i>	34	33	32
Baseline to week 36			
Mean (SD)	0.15 (0.35)	0.20 (0.39)	0.13 (0.37)
<i>n</i>	32	29	32
Baseline to week 48			
Mean (SD)	0.18 (0.38)	0.12 (0.37)	0.10 (0.34)
<i>n</i>	28	29	28

### Cost-effectiveness results

The costs and outcomes from the observed data are presented in *Table 26*. As the sample size of the observed data is small, the average costs and effects from the non-parametric bootstrap provide a more accurate and robust estimate of the distribution of the population costs and effects. *Table 27* shows the costs and QALYs gained for each treatment arm, the incremental costs and QALYs of the relevant comparisons and the resulting ICERs calculated from the bootstrap sample. The treatments are arranged in order of increasing cost so that the incremental costs and QALYs refer to the comparison between the neighbouring treatments in the table. The abatacept treatment group had the highest QALYs gained over the trial period, although the rituximab group had the lowest. The mean total cost was highest for the abatacept treatment group and lowest for the rituximab treatment group.

The results suggest that switching to alternative TNFi would be cost-effective compared with rituximab, as QALY gains are higher and costs are only slightly higher, leading to an ICER value of £5332.02 per QALY gained. This is well below the NICE acceptance threshold ( $\lambda = £20,000$ ), which indicates that switching to alternative TNFi would be a cost-effective treatment option. Conversely, the abatacept group has much higher costs and only marginal gains in QALYs compared with the alternative TNFi treatment group. This results in an ICER value of £253,967.96 per QALY gained, indicating that switching to abatacept compared with switching to alternative TNFi drug would not be cost-effective, as this ICER value is well above the NICE cost/QALY threshold. However, these results should be interpreted very cautiously given the small number of cases and the substantial probability of a very small QALY difference, resulting in a divisor close to zero. Moreover, the SD is likely to be underestimated.

*Figure 20* shows the joint distribution of incremental costs and incremental effects in the cost-effectiveness plane for alternative TNFi compared with rituximab and alternative TNFi compared with abatacept. The wide spread of the 'clouds' shows the high degree of uncertainty around the central results. This is to be expected given the small sample sizes.

**TABLE 26** Total costs and QALYs for each treatment (complete-case data)

Treatment group	Total cost (£), mean (SD)	QALYs, mean (SD)
Rituximab ( $n = 25$ )	9367.27 (3215.13)	0.46 (0.18)
Alternative TNFi ( $n = 21$ )	9680.23 (1263.71)	0.52 (0.14)
Abatacept ( $n = 24$ )	13,475.09 (4173.22)	0.53 (0.17)

**TABLE 27** Cost-effectiveness results (bootstrap of complete-case data)

Treatment group	Total cost (£), mean (SD)	Incremental cost (£)	QALYs, mean (SD)	Incremental QALYs	ICER (£/QALY)
Rituximab	9367.80 (624.70)		0.46 (0.04)		
Alternative TNFi compared with rituximab	9673.77 (268.03)	305.96	0.52 (0.03)	0.06	5332.02
Abatacept compared with alternative TNFi	13,441.77 (833.12)	3768.00	0.53 (0.03)	0.02	253,967.96

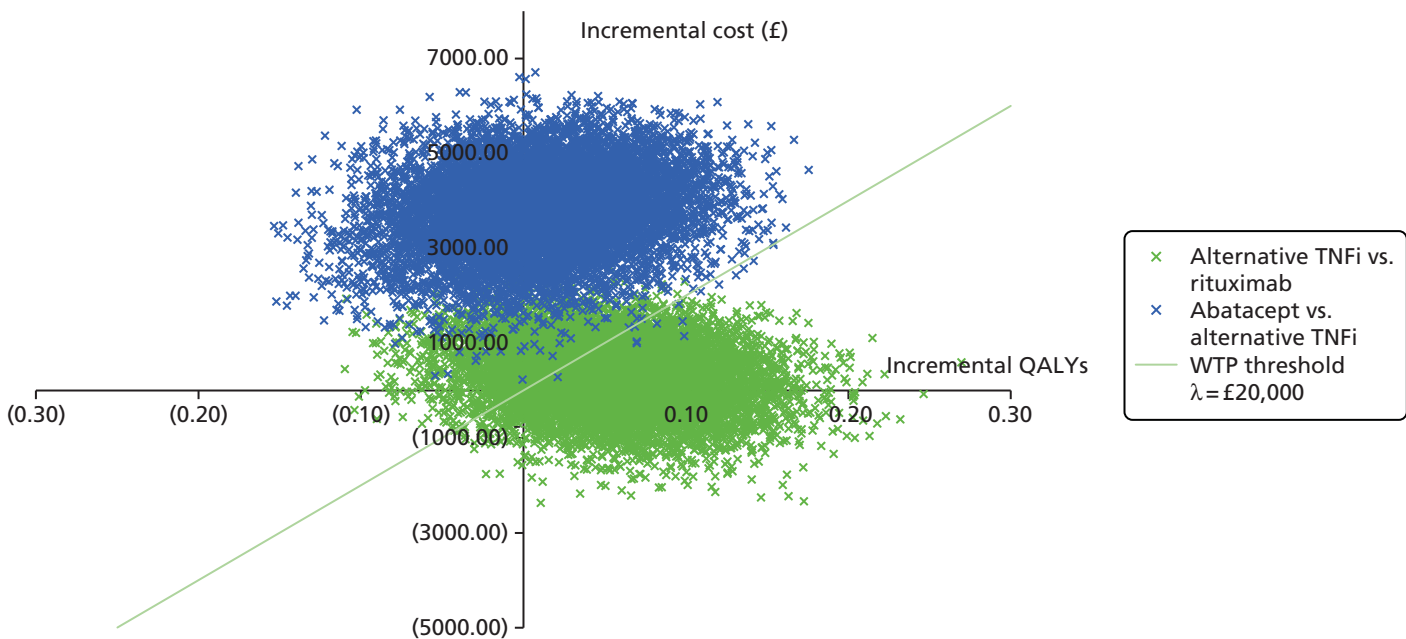

**FIGURE 20** Scatterplot on the cost-effectiveness plane: alternative TNFi vs. rituximab and abatacept vs. TNFi.

### Net benefit

The NMB for each treatment group is presented in *Table 28*. Given the decision rule, the NMB results indicate that rituximab and abatacept are not cost-effective treatments, although alternative TNFi has a positive NMB, indicating that it is cost-effective. These results suggest that switching to rituximab following an initial TNFi failure, as recommended in the current NICE guidance, is not the most efficient use of NHS resources. The probability that the treatments are cost-effective is presented in the cost-effectiveness acceptability curve shown in *Figure 21*. This shows that rituximab has the highest probability of being cost-effective for very low threshold values but that at threshold values > £6000 alternative TNFi has the highest probability of being cost-effective. At a £20,000 threshold, there is a 74.5% probability that alternative TNFi is cost-effective. Abatacept is never the most likely to be cost-effective and has a low probability of cost-effectiveness even at high threshold values.

### Sensitivity analysis

The costs and benefits from the observed data for each scenario explored in the sensitivity analyses are presented in *Table 29*. For each scenario the observed data were used to conduct a non-parametric bootstrap to provide the cost-effectiveness results, which are presented in *Table 30*.

Given that only complete cases were used for the base-case analysis, sensitivity analyses using mean imputation and multiple imputation were conducted, so that all randomised patients could be included. In each case, this does not alter the conclusion drawn from the base-case analysis, as alternative TNFi dominates all other treatment arms and is the optimal treatment option. We note that in the case of the mean imputation the increase in precision of these estimates is spurious, as the uncertainty attributable to imputation of a single value is ignored. Moreover, the imputed value did not take the characteristics of the missing cases into account; however, these are accounted for in the multiple imputation. Changing the administration of MTX to subcutaneous injection and adjusting for baseline differences also supports the results of the base-case analysis, with alternative TNFi remaining the most cost-effective treatment. Variances of population distributions are known to be underestimated in small samples, which is exacerbated by the high level of skewness in cost data, and we note that these sensitivity analyses have a large effect on the SD of the estimates (i.e. standard error). Consequently, we should be cautious when interpreting these results.

### Secondary analyses

Secondary analyses incorporating costs using a wider social perspective were also conducted. As such, the costs to the patient as well as health-care provider costs were included. Initially, this perspective was explored using complete cases: those patients with complete health-care cost and quality-of-life data (rituximab,  $n = 25$ ; abatacept,  $n = 24$ ; and alternative TNFi,  $n = 21$ ). In the complete-case analysis, those observations without complete cost and quality-of-life data were excluded. In addition, the wider social cost perspective was explored using imputed health-care cost and quality-of-life data in a similar way to the primary analysis. This enabled the inclusion of the whole sample in the analysis. The total costs and QALYs for each analysis, obtained from the observed data, are presented in *Table 31*. The observed data were used to conduct a non-parametric bootstrap to provide the cost-effectiveness results which are presented in *Table 32*. Including societal costs does not alter the conclusions drawn from the primary analyses, with alternative TNFi continuing to be the most cost-effective treatment.

**TABLE 28** Net monetary benefit (= £20,000)

Treatment group	Expected value NMB	SD of the estimates	95% CI
Rituximab	-160	1076	-2336 to 1877
Abatacept	-2790	947	-4594 to -921
Alternative TNFi	681	659	-643 to 1943

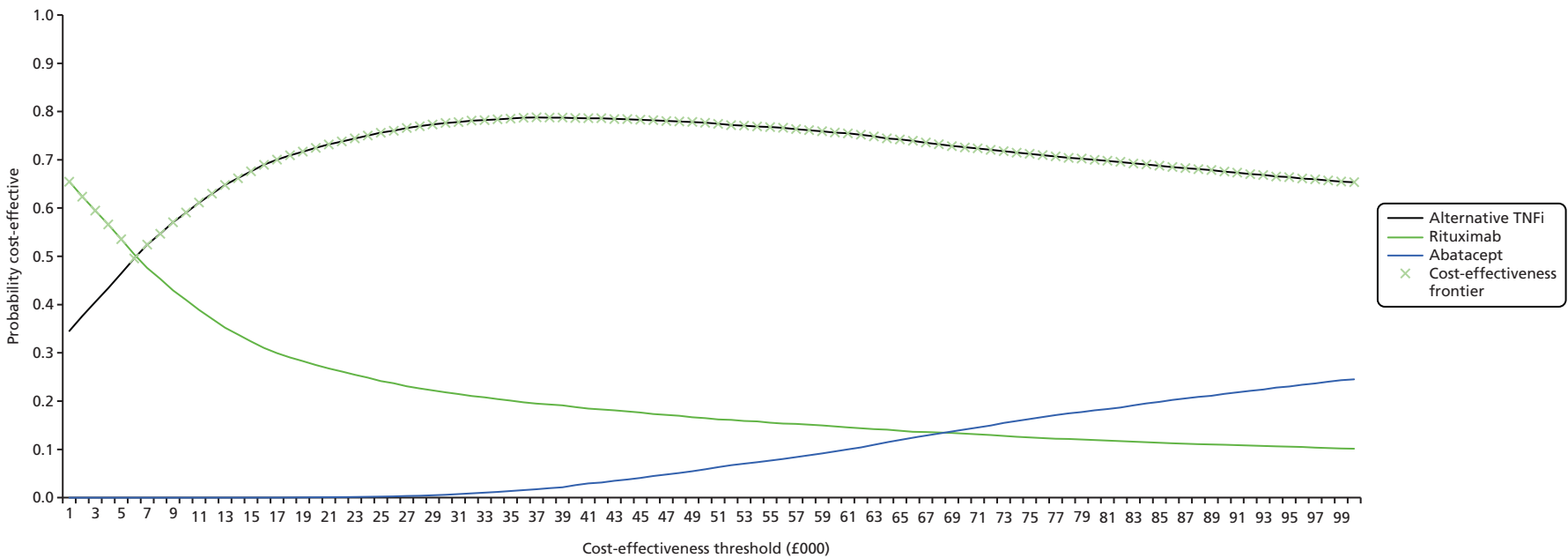

**FIGURE 21** Cost-effectiveness acceptability curve of an TNFi, rituximab and abatacept.

**TABLE 29** Sensitivity analyses: total costs and QALYs for each treatment (observed data)

Treatment group	Cost (£), mean (SD)	QALYs, mean (SD)
Mean imputed data		
Alternative TNFi ( <i>n</i> = 41)	9011.85 (1874.19)	0.51 (0.14)
Rituximab ( <i>n</i> = 40)	11,611.90 (15,601.15)	0.45 (0.15)
Abatacept ( <i>n</i> = 41)	12,484.63 (3792.04)	0.48 (0.18)
Multiple imputation		
Alternative TNFi ( <i>n</i> = 41)	7313.11 (2641.83)	0.54 (0.11)
Rituximab ( <i>n</i> = 40)	7563.66 (3466.92)	0.49 (0.15)
Abatacept ( <i>n</i> = 41)	9757.76 (5469.32)	0.53 (0.13)
Adjust baseline		
Rituximab ( <i>n</i> = 25)	9367.27 (3215.13)	0.48 (0.03)
Alternative TNFi ( <i>n</i> = 21)	9680.23 (1263.71)	0.51 (0.02)
Abatacept ( <i>n</i> = 24)	13,475.09 (4173.22)	0.51 (0.01)
Subcutaneous MTX		
Rituximab ( <i>n</i> = 25)	10,126.88 (3168.76)	0.46 (0.18)
Alternative TNFi ( <i>n</i> = 21)	10,519.07 (1281.09)	0.52 (0.14)
Abatacept ( <i>n</i> = 24)	14,217.46 (4219.53)	0.53 (0.17)

**TABLE 30** Sensitivity analyses: cost-effectiveness results (bootstrapped data)

Sensitivity analysis	Total cost (£), mean (SD)	Incremental cost (£)	QALY, mean (SD)	Incremental QALY	ICER (£)
Mean imputed data					
Alternative TNFi	9016.65 (283.76)		0.52 (0.02)		
Rituximab compared with alternative TNFi	11,675.67 (2428.85)	2659.01	0.45 (0.02)	-0.07	Dominated
Abatacept compared with alternative TNFi	12,489.87 (583.13)	3473.21	0.48 (0.03)	-0.04	Dominated
Multiple imputation					
Alternative TNFi	7311.22 (407.52)		0.54 (0.02)		
Rituximab compared with alternative TNFi	7577.46 (545.39)	266.24	0.49 (0.02)	-0.05	Dominated
Abatacept compared with alternative TNFi	9747.11 (847.59)	2435.89	0.53 (0.02)	-0.01	Dominated
Adjust baseline					
Rituximab	9358.71 (632.32)		0.48 (0.01)		
Alternative TNFi compared with rituximab	9681.06 (267.89)	322.35	0.51 (0.00)	0.03	10,948.76
Abatacept compared with alternative TNFi	13,470.63 (830.90)	3789.57	0.51 (0.00)	0.00	Dominated
Subcutaneous MTX					
Rituximab	10,123.97 (616.01)		0.46 (0.04)		
Alternative TNFi compared with rituximab	10,519.20 (273.74)	395.24	0.52 (0.03)	0.06	6863.26
Abatacept compared with alternative TNFi	14,214.03 (840.88)	3694.83	0.53 (0.03)	0.02	237,955.53

**TABLE 31** Secondary analyses: total costs and QALYs for each treatment (observed data)

Treatment group	Cost (£), mean (SD)	QALYs, mean (SD)
Complete case		
Rituximab ( <i>n</i> = 25)	10,234.14 (3398.08)	0.46 (0.18)
Alternative TNFi ( <i>n</i> = 21)	10,801.87 (2952.71)	0.52 (0.14)
Abatacept ( <i>n</i> = 24)	13,786.91 (4365.49)	0.53 (0.17)
Mean imputed data		
Alternative TNFi ( <i>n</i> = 41)	10,543.76 (6729.35)	0.51 (0.14)
Rituximab ( <i>n</i> = 40)	12,582.66 (15,489.78)	0.45 (0.15)
Abatacept ( <i>n</i> = 41)	13,177.04 (4319.81)	0.48 (0.18)
Multiple imputation		
Rituximab ( <i>n</i> = 40)	8482.35 (3918.54)	0.49 (0.15)
Alternative TNFi ( <i>n</i> = 41)	8855.76 (6511.18)	0.54 (0.11)
Abatacept ( <i>n</i> = 41)	10,461.48 (5720.53)	0.53 (0.13)

**TABLE 32** Secondary analyses: cost-effectiveness results (bootstrapped data)

Treatment group	Cost (£), mean (SD)	Incremental cost (£)	QALYs, mean (SD)	Incremental QALYs	ICER (£/QALY)
Complete case					
Rituximab	10,229.65 (660.23)		0.46 (0.04)		
Alternative TNFi compared with rituximab	10,811.13 (626.02)	581.48	0.52 (0.03)	0.06	10,145.42
Abatacept compared with alternative TNFi	13,785.52 (872.09)	2974.39	0.53 (0.04)	0.02	188,842.00
Mean imputed data					
Alternative TNFi	10,538.72 (1040.50)		0.51 (0.02)		
Rituximab compared with alternative TNFi	12,606.74 (2423.23)	2068.02	0.45 (0.02)	-0.06	Dominated
Abatacept compared with alternative TNFi	13,173.90 (673.21)	2635.17	0.48 (0.03)	-0.04	Dominated
Multiple imputation					
Alternative TNFi	8490.97 (599.60)		0.49 (0.02)		
Rituximab compared with alternative TNFi	8853.82 (997.76)	362.85	0.54 (0.02)	0.05	7647
Abatacept compared with alternative TNFi	10,449.61 (883.59)	1595.79	0.53 (0.02)	-0.01	Dominated

### Value of information analysis

There are 690,000 people with RA in the UK.<sup>3,141</sup> The population EVPI, at the NICE cost-effectiveness threshold value of lambda ( $\lambda = \text{£}20,000$ ), is  $\text{£}129,227,589$ . The population EVPI for other values of lambda is plotted in *Figure 22*. This indicates that it would be highly valuable to the NHS to reduce the current uncertainty regarding the effectiveness of alternative TNFi compared with rituximab in the management of RA.

### Conclusions

Owing to the sample size, the conclusions drawn from the cost-effectiveness analyses should be treated with caution. The analysis shows that switching to alternative TNFi following an initial TNFi failure *may* be a cost-effective option compared with rituximab, although switching to abatacept is unlikely to be cost-effective. Although the conclusion was robust to several alternative sensitivity analyses and was also corroborated when taking a broader societal perspective, which includes the costs incurred by patients there are caveats given that the full sample size was not achieved within the study. The value of information analysis indicates that it would be highly valuable to the NHS to reduce the current uncertainty regarding the effectiveness of alternative TNFi compared with rituximab in the management of RA.

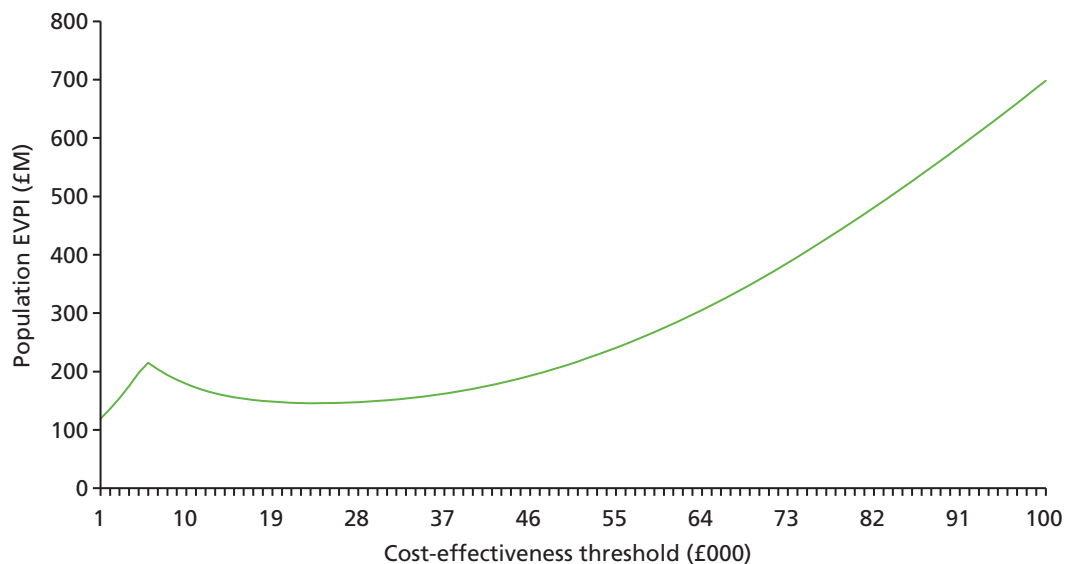

**FIGURE 22** Expected value of perfect information: population.



# Chapter 5 Discussion

## Principal findings

### Primary outcome

Owing to the early termination of the trial by the funders, the 'SWITCH' study was substantially underpowered in its objective to demonstrate non-inferiority of either alternative TNFi or abatacept to rituximab in terms of a reduction in the DAS28 at 24 weeks post randomisation. In the context of the low number of patients, alternative TNFi was non-inferior to rituximab in the ITT patient population, in that the estimate of the treatment effect excluded the non-inferiority margin of  $-0.6$  units, but non-inferiority was not demonstrated in the PP population, which was our prespecified requirement for demonstrating non-inferiority overall. Non-inferiority of abatacept to rituximab was not demonstrated in either patient population; the 95% CI did not exclude the non-inferiority margin of  $-0.6$  units and is therefore a plausible value.

As the trial was not permitted to recruit the target number of patients, the main interpretation of the results is based on the estimated treatment effect and corresponding precision. In the ITT patient population, the estimated mean difference in the reduction in the DAS28 after 24 weeks between alternative TNFi and rituximab was 0.30 units (95% CI  $-0.45$  to 1.05 units); the corresponding estimate for the difference between abatacept and rituximab was 0.04 units (95% CI  $-0.72$  to 0.79 units). Hence, the treatment effect in the ITT patient population is estimated with a precision of  $\pm 0.75$  units (corresponding to the half-width of the 95% CI).

Following exclusion of patients according to the prespecified criteria, the number of patients included in the PP population resulted in the treatment effect for both interventions compared with rituximab being estimated with very low precision. The estimated treatment effect for alternative TNFi compared with rituximab was  $-0.58$  units (95% CI  $-1.72$  to 0.55 units) and for abatacept was  $-0.15$  units (95% CI  $-1.27$  to 0.98 units) for the DAS28 at 24 weeks. Therefore, the treatment effect was estimated with a precision of  $\pm 1.13$  units, so there is large uncertainty in the estimate of the treatment effect in the PP population.

### Exploratory subgroup analysis

Subgroup effect estimates in this underpowered study should be interpreted cautiously; however, this component of the study was particularly novel and important clinically.

The suggestion of an association between negative serological status and poorer response to rituximab was consistent with meta-analyses,<sup>3-84</sup> a recent RCT of the first-line use of a bDMARD (as opposed to following first TNFi failure as with the 'SWITCH' study) in which non-inferiority of rituximab compared with a TNFi in seropositive patients<sup>142</sup> was observed and observational registry data.<sup>82</sup> The dependency of individual CCG receptiveness to secure such agreements, however, increases the potential for regional inconsistency in prescribing options and approach. Complete SWITCH data could have pushed for inclusion in future technology appraisals.

Primary and secondary non-response to an initial TNFi is well recognised and an important marker of the mechanisms for treatment failure, with secondary non-response suggesting a pharmacokinetic basis for failure and primary non-response suggesting the wrong target.<sup>143</sup> The results suggest that primary non-response may benefit from a change in class of bDMARD, whereas secondary non-response can be circumvented by use of alternative TNFi; these are consistent with other published literature, albeit from uncontrolled cohort studies.

### Secondary outcomes

Rheumatoid arthritis is a chronic disease that in the main requires long-term DMARD therapy. RCTs usually comprise a primary end point at week 24 (or earlier) that provides guidance only on short-term outcome whereas, in practice, reassurance on the maintenance (durability) of response is equally relevant. The secondary outcomes at weeks 36 and 48 go some way to providing this additional context. In the 'SWITCH' study, there was evidence of a greater improvement in disease activity (via the DAS28) at week 36 for alternative TNFi than for rituximab, although this difference was not maintained at week 48. There was no evidence of a difference in the DAS28 between abatacept and rituximab at any time point. However, when assessing disease activity in terms of the odds of achieving a DAS28 response ( $\geq 1.2$  units), there was no evidence of a difference for either intervention compared with rituximab at any of the time points. Moreover, there was no evidence of a difference in the odds of achieving an ACR20 response at 24 weeks post randomisation for either intervention relative to rituximab.

In addition to demonstrating a reduction in the DAS28, the overall disease activity status and setting of a target of at least low disease activity (if not remission) is now established as an important goal, which is coined as part of a 'treat to target' management approach of RA.<sup>144</sup> In the 'SWITCH' study, the proportions of patients on alternative TNFi and rituximab who achieved DAS28 low disease activity or remission at 24 weeks were similar, whereas the proportion of patients who achieved low disease activity or remission on abatacept was lower. Furthermore, among patients on alternative TNFi, the proportion achieving low disease activity or remission continued to increase to week 48, whereas among those on abatacept and rituximab this proportion fell between 24 and 48 weeks.

Functional and quality-of-life patient-reported outcome measures remain important indicators of patient well-being. Overall, a general improvement in HAQ-DI, RAQoL and the Patient Global Assessment of General Health was apparent over time, with no notable differences between treatment groups. There was a marked initial improvement in the Patient Global Assessment of Pain and Patient Global Assessment of Arthritis at 12 weeks across all three treatment groups. Small improvements in the HADS anxiety and depression scores over the 48-week period were observed in patients treated with alternative TNFi or abatacept, whereas no notable improvement was apparent in those receiving rituximab.

The safety profile was similar for all three treatments. Ten SAEs were reported in nine patients, of which three events in three patients were considered to be related to trial medications. There were no SUSARs reported. Two patients died, in both cases following the development of a SAE (one each in the rituximab and abatacept groups). Ten patients experienced toxicity resulting in a permanent cessation of treatment (four patients on alternative TNFi, two on abatacept and four on rituximab).

The most common protocol deviations related to receiving steroid treatment within 6 weeks of an end-point assessment, not being compliant with treatment to 24 weeks and receiving additional contraindicated treatment, all of which were likely to have contributed to a less conservative estimate of the mean treatment effect relative to the ITT patient population.

### Strengths and weaknesses

The principal strength of the 'SWITCH' study design was its emphasis on evaluation of a more defined and refined patient population, in keeping with the overall ambitions of the medical community for a more precise, tailored approach to medicine. This in itself, however, posed its own challenges, such as in recruitment. To date, almost all TNFi failure studies (RCTs and observational studies) have included any cause of failure (inefficacy and toxicity/intolerance), limiting the strength in application of the data on an individual patient level and also the potential mechanistic insights that can be drawn from clinical studies ('reverse translation'). The SWITCH study permitted the enrolment of only patients in whom TNFi had been found to be ineffective; although this is the predominant reason for failure, it will have limited the eligible patient pool. In addition, evaluating only patients on concomitant MTX (to recognise MTX synergy with bDMARD) will have limited the available recruitment pool further. In hindsight, accepting a less precise approach by including all patients (any cause of TNFi failure and TNFi with/without MTX combination) with

sensitivity analysis adjusting for MTX combination would have been more pragmatic and reduced some of the challenges in recruitment.

Nevertheless, the scientific design and rigorous conduct of this, albeit small, trial means that the SWITCH study will contribute to the evidence base for future research in RA, including in meta-analyses, and, hopefully, encourage future study design to address the factors such as those included in our exploratory subgroup analysis.

The obvious major weakness was the early termination, which resulted in a small number of patients recruited into the study. This naturally led to uncertainty in providing definitive conclusions. Despite this, the study identifies some indicators of response, which, although not definitive, provide support for, in particular, alternative TNFi rather than rituximab as a second-line bDMARD therapy in the management of RA. Furthermore, although an exploratory outcome, further diminished with the small sample size, the absence of a response to rituximab in the seronegative population is consistent with the published meta-analyses in efficacy trials.<sup>84</sup> These results, thus, further support that the hypothesis that an alternative bDMARD to rituximab may be preferable if a patient is seronegative. Moreover, if secondary non-response has resulted from a first TNFi, then it may also be more appropriate to consider a second TNFi.

It is important to emphasise, however, that no single treatment (or sequence) is appropriate for all patients and no single study will be able to address this completely. Although these and other complementary data may not provide definitive evidence on tailoring therapy, they do provide initial evidence to support a clinical judgement and increase the chance of treatment success on which subsequent studies can build. This approach to stratification of treatment would represent an advance to the current status of generally prescribing rituximab to all patients, thereby dismissing the potential benefits of switching to alternative therapies in patients who fail TNFi.

A further limitation of the design was the open-label nature of the study. Although blinding patients and treating clinicians to the allocated intervention would have reduced the risk and impact of any assessment bias, it would have been impractical to implement: each of the seven distinct bDMARDs in the SWITCH study involved a different route of delivery and dosing regimen, thus requiring multiple dummy infusions (necessitating additional inpatient attendance) and injections to maintain the blind. Such a treatment schedule was given careful consideration by our PPI advisor, and it was concluded that it would have imposed considerable burden on patients and was unethical, potentially either reducing recruitment further or increasing the rate of attrition throughout the study. However, the fact that all patients received an active therapy may have attenuated any bias introduced by the lack of blinding.

When the SWITCH study was designed, it included all three classes of bDMARD available for evaluation as second-line therapies when taken in combination with MTX, thereby reflecting the full range of therapies available. After the trial design and initiation, tocilizumab was approved as a first-line bDMARD and, hence, represented an additional option for the TNFi-inadequate response RA patient cohort. In addition, NICE has also approved the use of tocilizumab as a monotherapy, broadening the available therapies when given as monotherapy (without concomitant MTX).

The trial design allowed a pragmatic approach with clinician choice of the monoclonal antibody if the patient previously received etanercept. Moreover, a fourth monoclonal antibody, golimumab, was introduced into the alternative TNFi arm during the recruitment phase, thereby allowing further clinician choice across all available TNFis and ensuring further generalisability of the trial results to clinical practice. Although this pragmatic design may have introduced some heterogeneity into the results, it reflected current practice in the NHS and ensured that the EULAR guidance, recommending discussion between patient and treating clinician in the choice of bDMARD, was adhered to; this was considered important in order to maximise recruitment.

## Recruitment

It is important to provide information on recruitment strategies in the SWITCH study in order to inform future trials. We would refer the reader to the more exhaustive case study (Maya H Buch, Leeds Institute of Rheumatic and Musculoskeletal Medicine, University of Leeds and National Institute for Health Research (NIHR) Leeds Musculoskeletal Biomedical Research Unit, Leeds Teaching Hospitals NHS Trust, Leeds, UK, 2015) that systematically dissected each stage of the SWITCH study, from time of grant submission to active recruitment period. Some of the points and strategies to overcome the challenges faced in the SWITCH study are summarised below.

Despite attempts by the investigators to elicit reliable pre-trial recruitment estimates from centres, the numbers of eligible patients proposed were optimistic. In addition, the prolonged grant application and contracting processes resulted in a loss of momentum and the presence of competing studies that usurped the SWITCH study in some centres. Furthermore, centres reported research staff shortages and had to rely on clinical nurse specialist services to identify patients. Despite this, we recruited significantly more study sites than originally planned to address recruitment challenges. A clinical research fellow was appointed to support centres and to advise on co-ordination of research and clinical teams, but the heterogeneity in service provision meant that this had limited success. They were, however, effective in navigating the clinical challenges of patient recruitment and provided specific clinical guidance that aided recruitment. Other strategies for recruitment included clinic posters, leaflets, patient websites, e-bulletins and social media via the National Rheumatoid Arthritis Society. Fortnightly news flashes, monthly teleconferences and training days were also initiated to support centres.

As rituximab was the only NICE-approved treatment option in this context, a number of CCGs would not fund the experimental arms, so that centres were expected to underwrite the cost of these drugs (which was not a realistic option), although NICE provided clarification that its guidance applied to routine practice only and these treatments should be funded if part of a well-designed RCT. Such guidance was not mandated, meaning that CCGs could deviate from this and restrict participation by some centres, and many attempts to establish a dialogue with CCGs proved lengthy and unsuccessful. Discussions with pharmaceutical companies resulted in supplies of abatacept but not before additional delays attributable to negotiations and contract preparation.

The NHS routinely uses home health-care companies to deliver medication to patients' homes. These companies raised concerns regarding their regulatory authority to deliver trial IMPs only following activation of the initial three centres, which resulted in extended discussions, risk assessments and revisions to the protocol, during which recruitment was halted for 9 months at the beginning of the recruitment period.

Ultimately, as a result of discussions initiated with the NIHR Clinical Research Network (CRN) Coordinating Centre to overcome these obstacles, the CRN used the SWITCH trial as a case study to highlight the challenges in trial set-up, including areas for improvement in the CRN, feasibility and centre-specific approvals process and the insufficient resources (Maya H Buch, Leeds Institute of Rheumatic and Musculoskeletal Medicine, University of Leeds and NIHR Leeds Musculoskeletal Biomedical Research Unit, Leeds Teaching Hospitals NHS Trust, Leeds, UK, 2015).

The recruitment estimates may have been moderated had we repeated the recruitment survey once the study had been set up, and this is something that we would recommend as routine prior to study activation. Earlier engagement with the Medicines and Healthcare products Regulatory Agency, NIHR CRN and NICE may also have improved the trial status, although their influence on the NHS landscape and commissioning groups remains debatable. Clinician experience suggests that CCG approach to NICE guidance and TAs can be variable. To be able to deliver a fully 'independent' study to the diverse portfolio of studies, involvement of pharmaceutical partners was deliberately not considered at the start. Following the experience with the SWITCH study, however, this remains a naive aspiration, and, certainly, approaching industry to support IMP provision from the outset in future clinical trials of an IMP is vital to

militate against CCG lack of support and to prevent delays. Finally, given the complexity of the governance and practical requirements of a clinical trial of an IMP and lengthy approvals process, it is important that the set-up period for such trials is not underestimated and that any estimates of patient recruitment are based on robust local audits rather than clinician judgement.

## Health economic evaluation

### Principal findings

The trial-based cost-effectiveness analysis indicated that the current NICE guidance to switch to rituximab after initial TNFi failure was not the most cost-effective use of NHS resources. Instead, switching to alternative TNFi drug following an initial failure was the most cost-effective treatment option. Switching to alternative TNFi was more costly, but provided more QALYs than rituximab over a 48-month period. Moreover, switching to abatacept was not cost-effective compared with switching to alternative TNFi, as the associated costs were much higher and the QALY gain was small.

All three trial arms showed an increase in mean EQ-5D score over the 12-month trial period, with an initial increase from baseline to 12 weeks that was more or less maintained to 48 weeks. The small (non-significant) differences in QALYs resulting from these treatments could relate to the benefits being measured only over the trial period of 48 weeks, meaning that longer-term benefits could not be considered. In the primary analysis costs from a health and social services perspective and a wider social perspective were highest for the abatacept group and lowest for the rituximab group, but only slightly lower than the costs for the alternative TNFi group. These costs-effectiveness results were driven by the (statistically significant) difference in costs between abatacept and the other treatment groups. These results may change in longer follow-up if the side-effect profiles of the treatments are different when the drugs are used for prolonged periods, or effectiveness persists for different durations.

Base-case cost-effectiveness results were not sensitive to assumptions in a small number of deterministic sensitivity analyses. In line with the NICE reference case that indicates that costs to patients may be included in cost-effectiveness evaluations, results from a secondary analysis including the costs incurred by patients remained consistent, indicating that switching to alternative TNFi is cost-effective but switching to abatacept is not. However, these results should be treated with caution because of the small sample size, for which estimation of asymmetrical cost distributions is particularly difficult.

An estimate of the value of perfect information suggested that further research, in order that robust economic decisions are made, is worth in the order of £129M. This suggests that the early termination of the study by the funders may have imposed extremely large costs (either financial or in terms of health forgone) on the NHS, through allowing a high degree of decision uncertainty to persist. It is acknowledged, however, that, even had the trial achieved its expected sample size, it is unlikely to have addressed all uncertainty.

### Strengths and weaknesses of the economic analysis

The main strength of this analysis lies in the randomised controlled design of the study, which enabled the collection of high-quality data over the 48-week time horizon of the trial that were subsequently used in this analysis.

The small sample size achieved led to greater uncertainty in the conclusions drawn from the analyses and limited the scope of the analyses that could be performed. Only complete cases were used for the primary analysis. This meant that an even smaller sample was used for the primary analysis and the results must be treated with caution because of the potential for bias and the high likelihood of overestimation of the level of precision in the estimates of cost-effectiveness. The value of perfect information estimate indicates that further research is likely to be of value. Given the relatively short duration of follow-up, consideration of longer-term outcomes would be beneficial as part of any future research.

### Meaning of the study

The costs associated with TNFi drugs and abatacept are relatively high because of the larger number of treatments that are given weekly or fortnightly (see *Table 1*), compared with the costs of rituximab, which is given in weeks 1 and 2 with a potential repeat at 6 months. However, when all health economic data were taken into account, to give the full costs incurred of the treatments over 48 weeks from a health and social services perspective, the difference in overall costs between the TNFis used in this trial and rituximab is quite small. The overall costs associated with abatacept are much higher. With only a small, non-significant, difference in the change in EQ-5D scores between trial arms, it is these differences in costs that drive the results and show that the use of alternative TNFi following an initial TNFi failure could be viable as a cost-effective treatment option alongside the currently approved treatment, rituximab.

### Unanswered questions and further research

Although the analysis conducted here provides useful insights into the costs and effects of the treatment options in the trial period of 48 weeks, further research is required to provide evidence on the cost-effectiveness for alternative TNFi over a longer time horizon beyond 48 weeks. This could involve the development of an economic model that would also allow an extension to the value of information analysis conducted here to include the expected value of partial perfect information. This would provide a clearer idea of the areas around which further research should be conducted. Additional research would also be beneficial using a larger sample size to reduce the uncertainty in the conclusions drawn from the analysis and to ensure that a representative sample of the patient group is captured.

The existing evidence base has been limited to numerous small trials, whereas the ambition of the SWITCH randomised trial was to deliver a large-scale definitive trial that would have represented a paradigm shift in the RA community, delivering the largest RA pragmatic trial undertaken in the UK. Early termination of the SWITCH trial limits the conclusions that may be drawn and is therefore considered a lost opportunity to obtain definitive evidence on cost-effectiveness of either treatment option. However, the data presented may be used in meta-analysis in future research.

### Comparison with other studies

The only studies comparable with the SWITCH trial are the preliminary reports of the French study [Rotation of anti-TNF Or Change of class of biologic (ROC)] by Gottenberg *et al.*<sup>145</sup> and the Dutch study by Manders *et al.*<sup>87</sup> Although the ROC study is an instructive randomised trial that reached its primary outcome (non-TNFi bDMARD significantly superior to alternative TNFi), the multiple treatment options included within the non-TNFi randomised group limit the extent to which these data can inform the optimal targeted agent. The study by Manders *et al.*<sup>87</sup> found no significant difference between alternative TNFi, abatacept and rituximab, but further details on whether or not these treatments are equivalent are needed. Moreover, the study reported that, of the three treatments, rituximab was the most cost-effective and that treating patients with alternative TNFi was more cost-effective than treating patients with abatacept. However, similar to the SWITCH trial, this study is limited in what conclusions can be made because of the low number of patients recruited.

A requirement for non-inferiority trials is the assumption of assay sensitivity (constancy assumption), that is, establishing that the active control arm, rituximab, would be superior to placebo in the setting of the SWITCH trial.<sup>146</sup> One previous study, the REFLEX trial,<sup>49</sup> established the efficacy of rituximab compared with placebo in patients receiving MTX who had failed more than one treatment with a TNFi. The SWITCH trial was similar in a number of respects. The intervention was substantially the same over the 24-week period during which the primary end point was to be assessed; the primary and key secondary end points of the DAS28 reduction and ACR20 response were assessed at week 24, which was the key assessment time point in the REFLEX study. Moreover, the enrolled population had a similar age range and disease duration. Notable differences include the REFLEX study requiring a minimum level of disease activity in order for a patient to be enrolled, the difference in blinding (which had a much simpler requirement in the REFLEX

study's two-arm placebo-controlled study) and that patients were eligible if they had failed treatment with more than one TNFi and had demonstrated intolerance to prior TNFi therapy. The reduction in disease activity for rituximab in the SWITCH trial was sufficiently similar to that reported in the REFLEX study, supporting the conclusion that the SWITCH trial fulfilled the assay sensitivity requirement for a non-inferiority trial.

## Implications for health care and future research

The clinical question of whether or not alternative bDMARDs to rituximab are comparable in efficacy and safety outcomes in patients with RA who had not responded adequately to an initial TNFi bDMARD and MTX treatment remains unresolved. The lack of evidence, which is based on a single treatment (rituximab) being appropriate for all patients, limits guidance options.

In addition, NICE acknowledges this and has explicitly stated the need for comparative studies to inform future guidance.<sup>25</sup> In response to this unmet need, the scale and ambition of the SWITCH study was impressive, planned as one of the largest RA trials. It was, thus, particularly unfortunate that the trial was prematurely stopped. This has again made contribution to a meta-analysis the best outcome of this trial, although this also means the loss of a more definitive UK NHS-relevant answer; this is particularly disheartening when substantial investment into the study had already been made. Had the SWITCH trial been permitted to recruit to target, definitive evidence on whether or not either of the interventions were non-inferior to rituximab may have been provided, which may have opened up further treatment options for patients.

The 'SWITCH' study design also aimed to serve as a driver to the RA community to develop novel trial designs into our clinical trial repertoire, such that we can begin to address some of the challenges that currently impede delivery of the promise of personalised medicine in RA.<sup>147</sup> Incorporating stratification based on RF/ACPA seropositivity status and primary/secondary non-response to an initial TNFi would have allowed an exploratory analysis to determine if there was any evidence of a differential treatment response in these subgroups of patients, an aspect which no other RCT to date has attempted to do.

Finally, more seamless and integrated data capture is vital to support successful delivery of, in particular, large-scale definitive studies. Health informatics and electronic health records linking the needs of NHS with the NIHR and clinical research environment represents a core area for development to effectively embed research in the NHS.

The 'SWITCH' study provided several learning points for the academic community that will inform future initiatives. Many of the challenges illustrated deficiencies in the NHS organisational approach and infrastructure that are needed if it is to successfully deliver NIHR research, detailed by way of a case study initiated by the NIHR CRN (Maya H Buch, Leeds Institute of Rheumatic and Musculoskeletal Medicine, University of Leeds and NIHR Leeds Musculoskeletal Biomedical Research Unit, Leeds Teaching Hospitals NHS Trust, Leeds, UK, 2015).

Trial activity in the clinical area of RA is in its relative infancy compared with other high-prevalence clinical areas, such as cancer and cardiovascular disease. The SWITCH trial began to harness the academic and clinical community's commitment to trial activity and established a RCT research network, setting up a total of 35 centres: a massive achievement in itself that was truly representative of the wider rheumatology community. Continuing and ultimately delivering on the SWITCH trial, therefore, would have not just answered the trial question but also would have represented a substantial achievement for the RA community. The SWITCH study was therefore considered as an early investment for future (independent) RA trials that would allow the rheumatology community to build up its experience incrementally and, with this progression of trial design and better integration of research in the NHS, trial efficiency and landscape would have evolved. We hope future considerations take account of the SWITCH trial experience using the case study to support the rheumatology community in delivering on its ambition to improve the lives of people with RA (and other musculoskeletal conditions).





# Acknowledgements

## Clinical Trials Research Unit staff, University of Leeds

Dr Janine Gray (Principal Statistician and Co-applicant).

Mr Howard Collier [Data Manager (Acting)].

Mrs Catherine Reynolds (Data Manager).

Dr Catherine Fernandez (Head of Trial Management).

Miss Suzanne Hartley (former Head of Trial Management).

Cris Bunker (Senior Programmer).

## Trial Management Group

Mrs Nuria Navarro Coy (former Senior Trial Manager).

Professor Anne-Maree Keenan (Co-applicant).

Professor Anthony Redmond (Co-applicant).

Mrs Ailsa Bosworth (Patient Representative and Co-applicant).

## Data Monitoring Committee

Dr Robin Butler (Independent Clinician and Chairperson), Robert Jones and Agnes Hunt, Orthopaedic Hospital, Oswestry.

Dr Duncan Porter (Independent Clinician), University of Glasgow.

Professor Hazel Inskip (Independent Methodologist), University of Southampton.

## Trial Steering Committee

Professor Ernest Choy (Independent Clinician and Chairperson), University of Cardiff.

Dr Andrew Ostor (Independent Clinician), Addenbrookes Hospital, Cambridge.

Dr Martyn Lewis (Independent Statistician), University of Keele.

Dr Laura Bojke (Independent Health Economist), University of York.

Ms Sandra Purdy (Independent Member and Patient Representative).

## National Institute for Health Research Clinical Research Network

Nancy Lester (Business Development Director), CRN Executive Team.

Tomasz Kurdziel (Research Support and Management Lead), CRN: Yorkshire and the Humber.

Richard Wylde (Continuous Improvement Manager) Leeds and York Partnership NHS Foundation Trust.

## Participating centres

With thanks to all research staff at participating centres who arranged set-up of the study at their centres, provided and cared for trial patients and collected trial data. Special thanks to the principal investigators:

John Isaacs, Royal Victoria Infirmary, Newcastle.

Ian Bruce, Manchester Royal Infirmary, Manchester.

Euthalia Roussou, King George Hospital, Essex.

Srinivasan Venkat Chalam, Cannock Chase Hospital, Mid Staffordshire.

Christopher Buckley, Birmingham City Hospital.

Alison Kinder, Leicester Royal Infirmary, Leicester.

Lindsay Robertson, Derriford Hospital, Plymouth.

Sarah Westlake, Poole Hospital, Poole.

Paul Thompson, Poole Hospital, Poole.

Raashid Luqmani, Oxford Radcliffe Hospitals NHS Trust, Oxford.

Chris Deighton, Royal Derby Hospital, Derby.

Shabina Sultan, Airedale General Hospital, Steeton.

Mohamed Nisar, Queen's Hospital, Burton upon Trent.

Luke Gompels, Musgrove Park Hospital, Taunton.

John Pauling, Royal National Hospital for Rheumatic Diseases, Bath.

Rod Hughes, Ashford and St Peters NHS Trust, Lyne.

Vadivelu Saravanan, Queen Elizabeth Hospital, Gateshead.

Yusuf Patel, Hull Royal Infirmary, Hull.

Devesh Mewar, Broadgreen Hospital, Liverpool.

Bhaskar Dasgupta, Southend Hospital, Southend-on-Sea.

Costantino Pitzalis, Barts and The London NHS Trust (Mile End and Whipps Cross), London.

Hector Chinoy, Salford Royal NHS Foundation Trust.

Cathy Lawson, Harrogate District Hospital, Harrogate.

Bruce Kirkham, Guy's Hospital, London.

Dayavathi Ashok, County Durham & Darlington NHS Foundation Trust.

James Maxwell, Royal Hallamshire Hospital, Sheffield.

Shaheena Haque, University Hospital of South Manchester, Wythenshawe.

Pippa Watson, University Hospital of South Manchester, Wythenshawe.

Wahab Al-Allaf, New Cross Hospital (Royal Wolverhampton NHS Trust).

John Harvie, Raigmore Hospital, Inverness.

James Taylor, Northampton General Hospital, Northampton.

Ernest Wong, Queen Alexandra Hospital, Portsmouth.

Matthew Roy, Bristol Royal Infirmary.

Claire Gorman, Homerton University Hospital.

Sam Panthakalam Eastbourne District General Hospital, Eastbourne.

## Participants

Thank you to all trial patients for their essential contribution to the trial.

## Contributions of authors

**Sarah Brown** (Principal Statistician, Statistics) provided statistical supervision on the trial, led the drafting of the monograph and interpreted the results.

**Colin C Everett** (Senior Statistician, Statistics) conducted the statistical analysis and interpreted the results.

**Kamran Naraghi** (Clinical Research Fellow, Rheumatology) contributed to the conduct and monitoring of the trial and clinical queries.

**Claire Davies** (Senior Trial Manager, Trial Management) oversaw and co-ordinated the running of the trial, trial monitoring and negotiations on centre closures.

**Bryony Dawkins** (Health Economist, Health Economics) conducted the health economic analysis.

**Claire Hulme** (Professor of Health Economics, Health Economics) had overall responsibility for the reporting of the health economics analysis.

**Christopher McCabe** (Professor of Health Economics, Health Economics) reviewed the planned analyses and development of the cost-effectiveness chapter and contributed to the writing up of the final set of results.

**Sue Pavitt** (Professor in Translational and Applied Health Research, Dentistry) provided specialist musculoskeletal expertise in delivery of the trial.

The SWITCH trial was conceived by **Paul Emery** (Professor of Rheumatology, Rheumatology) and **Maya H Buch** (Professor of Rheumatology, Rheumatology). Maya H Buch also had overall responsibility for the trial.

**Linda Sharples** (Professor of Statistics, Statistics) had overall responsibility for the statistics and research methodology.

All authors contributed to the writing of the report and had the opportunity to critically revise it.

### Publication

Navarro Coy NC, Brown S, Bosworth A, Davies CT, Emery P, Everett CC, *et al*. The 'Switch' study protocol: a randomised-controlled trial of switching to an alternative tumour necrosis factor (TNF)-inhibitor drug or abatacept or rituximab in patients with rheumatoid arthritis who have failed an initial TNF-inhibitor drug. *BMC Musculoskelet Disord* 2014;**15**:452.

### Data sharing statement

The data sets during and/or analysed during the SWITCH trial will be available from the corresponding author on reasonable request.

## References

1. Lee DM, Weinblatt ME. Rheumatoid arthritis. *Lancet* 2001;**358**:903–11. [https://doi.org/10.1016/S0140-6736\(01\)06075-5](https://doi.org/10.1016/S0140-6736(01)06075-5)
2. Symmons D, Turner G, Webb R, Asten P, Barrett E, Lunt M, *et al.* The prevalence of rheumatoid arthritis in the United Kingdom: new estimates for a new century. *Rheumatology* 2002;**41**:793–800. <https://doi.org/10.1093/rheumatology/41.7.793>
3. Markenson JA. Worldwide trends in the socioeconomic impact and long-term prognosis of rheumatoid arthritis. *Semin Arthritis Rheum* 1991;**21**(Suppl. 2):4–12. [https://doi.org/10.1016/0049-0172\(91\)90046-3](https://doi.org/10.1016/0049-0172(91)90046-3)
4. Harris ED. Rheumatoid arthritis. Pathophysiology and implications for therapy. *N Engl J Med* 1990;**322**:1277–89. <http://dx.doi.org/10.1056/NEJM199005033221805>
5. Weinblatt ME. Rheumatoid arthritis: treat now, not later! *Ann Intern Med* 1996;**124**:773–4. <https://doi.org/10.7326/0003-4819-124-8-199604150-00012>
6. Barrett EM, Scott DG, Wiles NJ, Symmons DP. The impact of rheumatoid arthritis on employment status in the early years of disease: a UK community-based study. *Rheumatology* 2000;**39**:1403–9. <https://doi.org/10.1093/rheumatology/39.12.1403>
7. Young A, Dixey J, Kulinskaya E, Cox N, Davies P, Devlin J, *et al.* Which patients stop working because of rheumatoid arthritis? Results of five years' follow up in 732 patients from the Early RA Study (ERAS). *Ann Rheum Dis* 2002;**61**:335–40. <https://doi.org/10.1136/ard.61.4.335>
8. Aviña-Zubieta JA, Choi HK, Sadatsafavi M, Etminan M, Esdaile JM, Lacaille D. Risk of cardiovascular mortality in patients with rheumatoid arthritis: a meta-analysis of observational studies. *Arthritis Rheum* 2008;**59**:1690–7. <http://dx.doi.org/10.1002/art.24092>
9. Kaplan MJ. Cardiovascular disease in rheumatoid arthritis. *Curr Opin Rheumatol* 2006;**18**:289–97. <http://dx.doi.org/10.1097/01.bor.0000218951.65601.bf>
10. Peters MJ, Van Halm VP, Voskuyl AE, Smulders YM, Boers M, Lems WF, *et al.* Does rheumatoid arthritis equal diabetes mellitus as an independent risk factor for cardiovascular disease? A prospective study. *Arthritis Care Res* 2009;**61**:1571–9. <https://doi.org/10.1002/art.24836>
11. Mantel Å, Holmqvist M, Jernberg T, Wållberg-Jonsson S, Askling J. Rheumatoid arthritis is associated with a more severe presentation of acute coronary syndrome and worse short-term outcome. *Eur Heart J* 2015;**36**:3413–22. <https://doi.org/10.1093/eurheartj/ehv461>
12. Douglas KM, Pace AV, Treharne GJ, Saratzis A, Nightingale P, Erb N, *et al.* Excess recurrent cardiac events in rheumatoid arthritis patients with acute coronary syndrome. *Ann Rheum Dis* 2006;**65**:348–53. <https://doi.org/10.1136/ard.2005.037978>
13. Mantel Å, Holmqvist M, Nyberg F, Tornling G, Frisell T, Alfredsson L, *et al.* Risk Factors for the rapid increase in risk of acute coronary events in patients with new-onset rheumatoid arthritis: a nested case–control study. *Arthritis Rheum* 2015;**67**:2845–54. <https://doi.org/10.1002/art.39267>
14. Arts EE, Fransen J, den Broeder AA, Popa CD, van Riel PL. The effect of disease duration and disease activity on the risk of cardiovascular disease in rheumatoid arthritis patients. *Ann Rheum Dis* 2015;**74**:998–1003. <https://doi.org/10.1136/annrheumdis-2013-204531>
15. Wilske KR, Healey LA. Challenging the therapeutic pyramid: a new look at treatment strategies for rheumatoid arthritis. *J Rheumatol Suppl* 1990;**25**:4–7.

16. Wright V, Amos R. Do drugs change the course of rheumatoid arthritis? *Br Med J* 1980;**280**:964–6. <https://doi.org/10.1136/bmj.280.6219.964-a>
17. Nell VP, Machold KP, Eberl G, Stamm TA, Uffmann M, Smolen JS. Benefit of very early referral and very early therapy with disease-modifying anti-rheumatic drugs in patients with early rheumatoid arthritis. *Rheumatology* 2004;**43**:906–14. <http://dx.doi.org/10.1093/rheumatology/keh199>
18. Lard LR, Visser H, Speyer I, vander Horst-Bruinsma IE, Zwinderman AH, Breedveld FC, Hazes JM. Early versus delayed treatment in patients with recent-onset rheumatoid arthritis: comparison of two cohorts who received different treatment strategies. *Am J Med* 2001;**111**:446–51. [https://doi.org/10.1016/S0002-9343\(01\)00872-5](https://doi.org/10.1016/S0002-9343(01)00872-5)
19. van Aken J, Lard LR, le Cessie S, Hazes JM, Breedveld FC, Huizinga TW. Radiological outcome after four years of early versus delayed treatment strategy in patients with recent onset rheumatoid arthritis. *Ann Rheum Dis* 2004;**63**:274–9. <https://doi.org/10.1136/ard.2003.010298>
20. Korpela M, Laasonen L, Hannonen P, Kautiainen H, Leirisalo-Repo M, Hakala M, et al. Retardation of joint damage in patients with early rheumatoid arthritis by initial aggressive treatment with disease-modifying antirheumatic drugs: five-year experience from the FIN-RACo study. *Arthritis Rheum* 2004;**50**:2072–81. <http://dx.doi.org/10.1002/art.20351>
21. Verstappen SM, Jacobs JW, Bijlsma JW, Heurkens AH, van Booma-Frankfort C, Borg EJt, et al. Five-year follow-up of rheumatoid arthritis patients after early treatment with disease-modifying antirheumatic drugs versus treatment according to the pyramid approach in the first year. *Arthritis Rheum* 2003;**48**:1797–807. <https://doi.org/10.1002/art.11170>
22. Landewé RB, Boers M, Verhoeven AC, Westhovens R, van de Laar MA, Markusse HM, et al. COBRA combination therapy in patients with early rheumatoid arthritis: long-term structural benefits of a brief intervention. *Arthritis Rheum* 2002;**46**:347–56. <https://doi.org/10.1002/art.10083>
23. Maillefert JF, Combe B, Goupille P, Cantagrel A, Dougados M. Long term structural effects of combination therapy in patients with early rheumatoid arthritis: five year follow up of a prospective double blind controlled study. *Ann Rheum Dis* 2003;**62**:764–6. <https://doi.org/10.1136/ard.62.8.764>
24. Finckh A, Liang MH, van Herckenrode CM, de Pablo P. Long-term impact of early treatment on radiographic progression in rheumatoid arthritis: a meta-analysis. *Arthritis Rheum* 2006;**55**:864–72. <http://dx.doi.org/10.1002/art.22353>
25. NICE. *Rheumatoid Arthritis in Adults: Management*. London: NICE; 2015.
26. Smolen JS, Landewé R, Breedveld FC, Buch M, Burmester G, Dougados M, et al. EULAR recommendations for the management of rheumatoid arthritis with synthetic and biological disease-modifying antirheumatic drugs: 2013 update. *Ann Rheum Dis* 2014;**73**:492–509. <http://dx.doi.org/10.1136/annrheumdis-2013-204573>
27. Wolfe F. The epidemiology of drug treatment failure in rheumatoid arthritis. *Baillieres Clin Rheumatol* 1995;**9**:619–32. [https://doi.org/10.1016/S0950-3579\(05\)80305-X](https://doi.org/10.1016/S0950-3579(05)80305-X)
28. Brooks PM. Clinical management of rheumatoid arthritis. *Lancet* 1993;**341**:286–90. [https://doi.org/10.1016/0140-6736\(93\)92628-7](https://doi.org/10.1016/0140-6736(93)92628-7)
29. Feldmann M, Brennan FM, Maini RN. Role of cytokines in rheumatoid arthritis. *Annu Rev Immunol* 1996;**14**:397–440. <http://dx.doi.org/10.1146/annurev.immunol.14.1.397>
30. Elliott MJ, Maini RN, Feldmann M, Long-Fox A, Charles P, Katsikis P, et al. Treatment of rheumatoid arthritis with chimeric monoclonal antibodies to tumor necrosis factor  $\alpha$ . *Arthritis Rheum* 1993;**36**:1681–90. <https://doi.org/10.1002/art.1780361206>

31. Moreland LW, Baumgartner SW, Schiff MH, Tindall EA, Fleischmann RM, Weaver AL, *et al.* Treatment of rheumatoid arthritis with a recombinant human tumor necrosis factor receptor (p75)-Fc fusion protein. *N Engl J Med* 1997;**337**:141–7. <http://dx.doi.org/10.1056/NEJM199707173370301>
32. Maini R, St Clair EW, Breedveld F, Furst D, Kalden J, Weisman M, *et al.* Infliximab (chimeric anti-tumour necrosis factor  $\alpha$  monoclonal antibody) versus placebo in rheumatoid arthritis patients receiving concomitant methotrexate: a randomised phase III trial. *Lancet* 1999;**354**:1932–9. [https://doi.org/10.1016/S0140-6736\(99\)05246-0](https://doi.org/10.1016/S0140-6736(99)05246-0)
33. Weinblatt ME, Keystone EC, Furst DE, Moreland LW, Weisman MH, Birbara CA, *et al.* Adalimumab, a fully human anti-tumor necrosis factor alpha monoclonal antibody, for the treatment of rheumatoid arthritis in patients taking concomitant methotrexate: the ARMADA trial. *Arthritis Rheum* 2003;**48**:35–45. <http://dx.doi.org/10.1002/art.10697>
34. Lipsky PE, van der Heijde DM, St Clair EW, Furst DE, Breedveld FC, Kalden JR, *et al.* Infliximab and methotrexate in the treatment of rheumatoid arthritis. Anti-Tumor Necrosis Factor Trial in Rheumatoid Arthritis with Concomitant Therapy Study Group. *N Engl J Med* 2000;**343**:1594–602. <http://dx.doi.org/10.1056/NEJM200011303432202>
35. Keystone E, Heijde DVD, Mason D, Landewé R, Vollenhoven RV, Combe B, *et al.* Certolizumab pegol plus methotrexate is significantly more effective than placebo plus methotrexate in active rheumatoid arthritis: findings of a fifty-two-week, phase III, multicenter, randomized, double-blind, placebo-controlled, parallel-group study. *Arthritis Rheum* 2008;**58**:3319–29. <https://doi.org/10.1002/art.23964>
36. Emery P, Fleischmann RM, Moreland LW, Hsia EC, Strusberg I, Durez P, *et al.* Golimumab, a human anti-tumor necrosis factor alpha monoclonal antibody, injected subcutaneously every four weeks in methotrexate-naive patients with active rheumatoid arthritis: twenty-four-week results of a phase III, multicenter, randomized, double-blind, placebo-controlled study of golimumab before methotrexate as first-line therapy for early-onset rheumatoid arthritis. *Arthritis Rheum* 2009;**60**:2272–83. <http://dx.doi.org/10.1002/art.24638>
37. Chen Y-F, Jobanputra P, Barton P, Jowett S, Bryan S, Clark W, *et al.* A systematic review of the effectiveness of adalimumab, etanercept and infliximab for the treatment of rheumatoid arthritis in adults and an economic evaluation of their cost-effectiveness. *Health Technol Assess* 2006;**10**(42). <https://doi.org/10.3310/hta10420>
38. Mewar D, Wilson AG. Treatment of rheumatoid arthritis with tumour necrosis factor inhibitors. *Br J Pharmacol* 2011;**162**:785–91. <http://dx.doi.org/10.1111/j.1476-5381.2010.01099.x>
39. Buch MH, Conaghan PG, Quinn MA, Bingham SJ, Veale D, Emery P. True infliximab resistance in rheumatoid arthritis: a role for lymphotoxin alpha? *Ann Rheum Dis* 2004;**63**:1344–6. <http://dx.doi.org/10.1136/ard.2003.014878>
40. Scallon B, Cai A, Solowski N, Rosenberg A, Song XY, Shealy D, Wagner C. Binding and functional comparisons of two types of tumor necrosis factor antagonists. *J Pharmacol Exp Ther* 2002;**301**:418–26. <https://doi.org/10.1124/jpet.301.2.418>
41. Scallon BJ, Moore MA, Trinh H, Knight DM, Ghrayeb J. Chimeric anti-TNF- $\alpha$  monoclonal antibody cA2 binds recombinant transmembrane TNF- $\alpha$  and activates immune effector functions. *Cytokine* 1995;**7**:251–9. <https://doi.org/10.1006/cyto.1995.0029>
42. Scallon BJ, Trinh H, Nedelman M, Brennan FM, Feldmann M, Ghrayeb J. Functional comparisons of different tumour necrosis factor receptor/IgG fusion proteins. *Cytokine* 1995;**7**:759–70. <https://doi.org/10.1006/cyto.1995.0091>
43. Choy EH, Panayi GS. Cytokine pathways and joint inflammation in rheumatoid arthritis. *N Engl J Med* 2001;**344**:907–16. <http://dx.doi.org/10.1056/NEJM200103223441207>

44. Edwards JC, Szczepanski L, Szechinski J, Filipowicz-Sosnowska A, Emery P, Close DR, *et al.* Efficacy of B-cell-targeted therapy with rituximab in patients with rheumatoid arthritis. *N Engl J Med* 2004;**350**:2572–81. <http://dx.doi.org/10.1056/NEJMoa032534>
45. Smolen JS, Schoels MM, Nishimoto N, Breedveld FC, Burmester GR, Dougados M, *et al.* Consensus statement on blocking the effects of interleukin-6 and in particular by interleukin-6 receptor inhibition in rheumatoid arthritis and other inflammatory conditions. *Ann Rheum Dis* 2013;**72**:482–92. <https://doi.org/10.1136/annrheumdis-2012-202469>
46. Buch MH, Boyle DL, Rosengren S, Saleem B, Reece RJ, Rhodes LA, *et al.* Mode of action of abatacept in rheumatoid arthritis patients having failed tumour necrosis factor blockade: a histological, gene expression and dynamic magnetic resonance imaging pilot study. *Ann Rheum Dis* 2009;**68**:1220–7. <https://doi.org/10.1136/ard.2008.091876>
47. Kremer JM, Genant HK, Moreland LW, Russell AS, Emery P, Abud-Mendoza C, *et al.* Effects of abatacept in patients with methotrexate-resistant active rheumatoid arthritis: a randomized trial. *Ann Intern Med* 2006;**144**:865–76. <https://doi.org/10.7326/0003-4819-144-12-200606200-00003>
48. Smolen JS, Beaulieu A, Rubbert-Roth A, Ramos-Remus C, Rovensky J, Alecock E, *et al.* Effect of interleukin-6 receptor inhibition with tocilizumab in patients with rheumatoid arthritis (OPTION study): a double-blind, placebo-controlled, randomised trial. *Lancet* 2008;**371**:987–97. [https://doi.org/10.1016/S0140-6736\(08\)60453-5](https://doi.org/10.1016/S0140-6736(08)60453-5)
49. Cohen SB, Emery P, Greenwald MW, Dougados M, Furie RA, Genovese MC, *et al.* Rituximab for rheumatoid arthritis refractory to anti-tumor necrosis factor therapy: Results of a multicenter, randomized, double-blind, placebo-controlled, phase III trial evaluating primary efficacy and safety at twenty-four weeks. *Arthritis Rheum* 2006;**54**:2793–806. <http://dx.doi.org/10.1002/art.22025>
50. Emery P, Keystone E, Tony H, Cantagrel A, Van Vollenhoven R, Sanchez A, *et al.* IL-6 receptor inhibition with tocilizumab improves treatment outcomes in patients with rheumatoid arthritis refractory to anti-tumour necrosis factor biologicals: results from a 24-week multicentre randomised placebo-controlled trial. *Ann Rheum Dis* 2008;**67**:1516–23. <https://doi.org/10.1136/ard.2008.092932>
51. Genovese MC, Becker JC, Schiff M, Luggen M, Sherrer Y, Kremer J, *et al.* Abatacept for rheumatoid arthritis refractory to tumor necrosis factor alpha inhibition. *N Engl J Med* 2005;**353**:1114–23. <https://doi.org/10.1056/NEJMoa050524>
52. Rubbert-Roth A, Finckh A. Treatment options in patients with rheumatoid arthritis failing initial TNF inhibitor therapy: a critical review. *Arthritis Res Ther* 2009;**11**:1. <https://doi.org/10.1186/ar2666>
53. NICE. *Adalimumab, Etanercept and Infliximab for the Treatment of Rheumatoid Arthritis*. London: NICE; 2007.
54. NICE. *Certolizumab Pegol for the Treatment of Rheumatoid Arthritis*. London: NICE; 2010.
55. NICE. *Golimumab for the Treatment of Rheumatoid Arthritis after the Failure of Previous Disease-modifying Anti-rheumatic Drugs*. London: NICE; 2011.
56. NICE. *Adalimumab, Etanercept, Infliximab, Certolizumab Pegol, Golimumab, Tocilizumab and Abatacept for Rheumatoid Arthritis not Previously Treated with DMARDs or After Conventional DMARDs only have Failed*. London: NICE; 2016.
57. NICE. *Tocilizumab for the Treatment of Rheumatoid Arthritis*. London: NICE; 2012.
58. NICE. *Abatacept for Treating Rheumatoid Arthritis after the Failure of Conventional Disease-modifying Anti-rheumatic Drugs*. Rapid Review of Technology Appraisal Guidance 234. London: NICE; 2013.



59. NICE. *Adalimumab, Etanercept, Infliximab, Rituximab and Abatacept for the Treatment of Rheumatoid Arthritis after the Failure of a TNF Inhibitor*. London: NICE; 2010.
60. Buch MH, Bingham SJ, Bejarano V, Bryer D, White J, Reece R, *et al*. Therapy of patients with rheumatoid arthritis: outcome of infliximab failures switched to etanercept. *Arthritis Rheum* 2007;**57**:448–53. <http://dx.doi.org/10.1002/art.22617>
61. Buch MH, Emery P. Nonresponse to tumor necrosis factor antagonists – is there any point in re-treatment? *Nat Clin Pract Rheumatol* 2006;**2**:288–9. <https://doi.org/10.1038/ncprheum0210>
62. Buch MH, Seto Y, Bingham SJ, Bejarano V, Bryer D, White J, Emery P. C-reactive protein as a predictor of infliximab treatment outcome in patients with rheumatoid arthritis: defining subtypes of nonresponse and subsequent response to etanercept. *Arthritis Rheum* 2005;**52**:42–8. <http://dx.doi.org/10.1002/art.20711>
63. Gomez-Reino JJ, Carmona L, BIOBADASER Group. Switching TNF antagonists in patients with chronic arthritis: an observational study of 488 patients over a four-year period. *Arthritis Res Ther* 2006;**8**:R29. <https://doi.org/10.1186/ar1881>
64. Wick M, Ernestam S, Lindblad S, Bratt J, Klareskog L, Van Vollenhoven R. Adalimumab (Humira®) restores clinical response in patients with secondary loss of efficacy from infliximab (Remicade®) or etanercept (Enbrel®): results from the STURE registry at Karolinska University Hospital. *Scand J Rheumatol* 2005;**34**:353–8. <https://doi.org/10.1080/03009740510026887>
65. van Vollenhoven RF. Switching between biological agents. *Clin Exp Rheumatol* 2004;**22**(Suppl. 5):115–21.
66. Hansen KE, Hildebrand JP, Genovese MC, Cush JJ, Patel S, Cooley DA, *et al*. The efficacy of switching from etanercept to infliximab in patients with rheumatoid arthritis. *J Rheumatol* 2004;**31**:1098–102.
67. van Vollenhoven R, Harju A, Brannemark S, Klareskog L. Treatment with infliximab (Remicade) when etanercept (Enbrel) has failed or vice versa: data from the STURE registry showing that switching tumour necrosis factor alpha blockers can make sense. *Ann Rheum Dis* 2003;**62**:1195–8. <https://doi.org/10.1136/ard.2003.009589>
68. Hyrich KL, Lunt M, Watson KD, Symmons DP, Silman AJ, British Society for Rheumatology Biologics Register. Outcomes after switching from one anti-tumor necrosis factor alpha agent to a second anti-tumor necrosis factor alpha agent in patients with rheumatoid arthritis: results from a large UK national cohort study. *Arthritis Rheum* 2007;**56**:13–20. <https://doi.org/10.1002/art.22331>
69. Hjardem E, Østergaard M, Pødenphant J, Tarp U, Andersen LS, Bing J, *et al*. Do rheumatoid arthritis patients in clinical practice benefit from switching from infliximab to a second tumor necrosis factor alpha inhibitor? *Ann Rheum Dis* 2007;**66**:1184–9. <https://doi.org/10.1136/ard.2006.054742>
70. Nikas SN, Voulgari PV, Alamanos Y, Papadopoulos CG, Venetsanopoulou AI, Georgiadis AN, Drosos AA. Efficacy and safety of switching from infliximab to adalimumab: a comparative controlled study. *Ann Rheum Dis* 2006;**65**:257–60. <https://doi.org/10.1136/ard.2005.039099>
71. Carmona L, Ortiz A, Abad MA. How good is to switch between biologics? A systematic review of the literature. *Acta Reumatol Port* 2007;**32**:113–28.
72. Lopez-Olivo M, Roundtree A, Ortiz Z, Skidmore B, Suarez-Almazor M. Switching between anti-TNF agents treatments for rheumatoid arthritis: a systematic review. *Ann Rheum Dis*, abstract no. 40, p. 189.

73. Smolen JS, Kay J, Doyle MK, Landewé R, Matteson EL, Wollenhaupt J, *et al.* Golimumab in patients with active rheumatoid arthritis after treatment with tumour necrosis factor  $\alpha$  inhibitors (GO-AFTER study): a multicentre, randomised, double-blind, placebo-controlled, phase III trial. *Lancet* 2009;**374**:210–21. [https://doi.org/10.1016/S0140-6736\(09\)60506-7](https://doi.org/10.1016/S0140-6736(09)60506-7)
74. Schiff MH, von Kempis J, Goldblum R, Tesser JR, Mueller RB. Rheumatoid arthritis secondary non-responders to TNF can attain an efficacious and safe response by switching to certolizumab pegol: a phase IV, randomised, multicentre, double-blind, 12-week study, followed by a 12-week open-label phase. *Ann Rheum Dis* 2014;**73**:2174–7. <http://dx.doi.org/10.1136/annrheumdis-2014-205325>
75. Weinblatt ME, Fleischmann R, van Vollenhoven RF, Emery P, Huizinga TWJ, Cutolo M, *et al.* Twenty-eight-week results from the REALISTIC phase IIIb randomized trial: efficacy, safety and predictability of response to certolizumab pegol in a diverse rheumatoid arthritis population. *Arthritis Res Ther* 2015;**17**:325. <http://dx.doi.org/10.1186/s13075-015-0841-9>
76. Cohen SB, Keystone E, Genovese MC, Emery P, Peterfy C, Tak PP, *et al.* Continued inhibition of structural damage over 2 years in patients with rheumatoid arthritis treated with rituximab in combination with methotrexate. *Ann Rheum Dis* 2010;**69**:1158–61. <http://dx.doi.org/10.1136/ard.2009.119222>
77. Genovese M, Schiff M, Luggen M, Becker J, Aranda R, Teng J, *et al.* Efficacy and safety of the selective co-stimulation modulator abatacept following 2 years of treatment in patients with rheumatoid arthritis and an inadequate response to anti-tumour necrosis factor therapy. *Ann Rheum Dis* 2008;**67**:547–54. <https://doi.org/10.1136/ard.2007.074773>
78. Emery P, Tony H, Kremer J. Long-term efficacy of tocilizumab (TCZ) in RA patients (PTS) who have inadequate response to anti-TNF therapy (TNF-IR). *Ann Rheum Dis* 2011;**70**:615.
79. Finckh A, Ciurea A, Brulhart L, Kyburz D, Möller B, Dehler S, *et al.* B cell depletion may be more effective than switching to an alternative anti-tumor necrosis factor agent in rheumatoid arthritis patients with inadequate response to anti-tumor necrosis factor agents. *Arthritis Rheum* 2007;**56**:1417–23. <https://doi.org/10.1002/art.22520>
80. Finckh A, Ciurea A, Brulhart L, Möller B, Walker UA, Courvoisier D, *et al.* Which subgroup of patients with rheumatoid arthritis benefits from switching to rituximab versus alternative anti-tumour necrosis factor (TNF) agents after previous failure of an anti-TNF agent? *Ann Rheum Dis* 2010;**69**:387–93. <http://dx.doi.org/10.1136/ard.2008.105064>
81. Soliman MM, Hyrich KL, Lunt M, Watson KD, Symmons DP, Ashcroft DM. Rituximab or a second anti-tumor necrosis factor therapy for rheumatoid arthritis patients who have failed their first anti-tumor necrosis factor therapy? Comparative analysis from the British Society for Rheumatology Biologics Register. *Arthritis Care Res* 2012;**64**:1108–15.
82. Emery P, Gottenberg J, Rubbert-Roth A, Sarzi-Puttini P, Choquette D, Taboada VM, *et al.* Rituximab versus an alternative TNF inhibitor in patients with rheumatoid arthritis who failed to respond to a single previous TNF inhibitor: SWITCH-RA, a global, observational, comparative effectiveness study. *Ann Rheum Dis* 2015;**74**:979–84. <https://doi.org/10.1136/annrheumdis-2013-203993>
83. Finckh A, Möller B, Dudler J, Walker UA, Kyburz D, Gabay C, physicians of the Swiss Clinical Quality Management for Rheumatoid Arthritis. Evolution of radiographic joint damage in rituximab-treated versus TNF-treated rheumatoid arthritis cases with inadequate response to TNF antagonists. *Ann Rheum Dis* 2012;**71**:1680–5. <https://doi.org/10.1136/annrheumdis-2011-201016>
84. Isaacs JD, Cohen SB, Emery P, Tak PP, Wang J, Lei G, *et al.* Effect of baseline rheumatoid factor and anti-citrullinated peptide antibody serotype on rituximab clinical response: a meta-analysis. *Ann Rheum Dis* 2013;**72**:329–36. <https://doi.org/10.1136/annrheumdis-2011-201117>

85. Harrold LR, Reed GW, Kremer JM, Curtis JR, Solomon DH, Hochberg MC, *et al.* The comparative effectiveness of abatacept versus anti-tumour necrosis factor switching for rheumatoid arthritis patients previously treated with an anti-tumour necrosis factor. *Ann Rheum Dis* 2013;**74**:430–6. <https://doi.org/10.1136/annrheumdis-2013-203936>
86. Gottenberg JE, Brocq O, Perdriger A, Lassoued S, Berthelot JM, Wendling D, *et al.* non-TNF-targeted biologic vs a second anti-TNF drug to treat rheumatoid arthritis in patients with insufficient response to a first anti-TNF drug: a randomized clinical trial. *JAMA* 2016;**316**:1172–80. <http://dx.doi.org/10.1001/jama.2016.13512>
87. Manders SH, Kievit W, Adang E, Brus HL, Moens HJ, Hartkamp A, *et al.* Cost-effectiveness of abatacept, rituximab, and TNFi treatment after previous failure with TNFi treatment in rheumatoid arthritis: a pragmatic multi-centre randomised trial. *Arthritis Res Ther* 2015;**17**:134. <http://dx.doi.org/10.1186/s13075-015-0630-5>
88. Chatzidionysiou K, Lie E, Nasonov E, Lukina G, Hetland ML, Tarp U, *et al.* Highest clinical effectiveness of rituximab in autoantibody-positive patients with rheumatoid arthritis and in those for whom no more than one previous TNF antagonist has failed: pooled data from 10 European registries. *Ann Rheum Dis* 2011;**70**:1575–80. <https://doi.org/10.1136/ard.2010.148759>
89. Sellam J, Hendel-Chavez H, Rouanet S, Abbed K, Combe B, Le Loët X, *et al.* B cell activation biomarkers as predictive factors for the response to rituximab in rheumatoid arthritis: a six-month, national, multicenter, open-label study. *Arthritis Rheum* 2011;**63**:933–8. <http://dx.doi.org/10.1002/art.30233>
90. Gottenberg JE, Ravaud P, Cantagrel A, Combe B, Flipo RM, Schaeffer T, *et al.* Positivity for anti-cyclic citrullinated peptide is associated with a better response to abatacept: data from the 'Orencia and Rheumatoid Arthritis' registry. *Ann Rheum Dis* 2012;**71**:1815–19. <http://dx.doi.org/10.1136/annrheumdis-2011-201109>
91. Gottenberg J, Courvoisier D, Hernandez M, Iannone F, Lie E, Canhão H, *et al.* Brief report: association of rheumatoid factor and anti-citrullinated protein antibody positivity with better effectiveness of abatacept: results from the Pan-European Registry Analysis. *Arthritis Rheum* 2016;**68**:1346–52. <https://doi.org/10.1002/art.39595>
92. Pieper J, Herrath J, Raghavan S, Muhammad K, van Vollenhoven R, Malmström V. CTLA4-Ig (abatacept) therapy modulates T cell effector functions in autoantibody-positive rheumatoid arthritis patients. *BMC Immunol* 2013;**14**:1. <https://doi.org/10.1186/1471-2172-14-34>
93. Nüßlein HG, Alten R, Galeazzi M, Lorenz H-M, Nurmohamed MT, Bensen WG, *et al.* Prognostic factors for abatacept retention in patients who received at least one prior biologic agent: an interim analysis from the observational, prospective ACTION study. *BMC Musculoskelet Disord* 2015;**16**:1. <https://doi.org/10.1186/s12891-015-0636-9>
94. Kawashiri S-y, Kawakami A, Iwamoto N, Fujikawa K, Aramaki T, Tamai M, *et al.* In rheumatoid arthritis patients treated with tocilizumab, the rate of clinical disease activity index (CDAI) remission at 24 weeks is superior in those with higher titers of IgM-rheumatoid factor at baseline. *Mod Rheumatol* 2011;**21**:370–4. <https://doi.org/10.3109/s10165-010-0409-0>
95. Pers YM, Fortunet C, Constant E, Lambert J, Godfrin-Valnet M, De Jong A, *et al.* Predictors of response and remission in a large cohort of rheumatoid arthritis patients treated with tocilizumab in clinical practice. *Rheumatology* 2014;**53**:76–84. <http://dx.doi.org/10.1093/rheumatology/ket301>
96. Dass S, Vital EM, Emery P. Development of psoriasis after B cell depletion with rituximab. *Arthritis Rheum* 2007;**56**:2715–18. <http://dx.doi.org/10.1002/art.22811>
97. Cohen JD, Bournerias I, Buffard V, Paufler A, Chevalier X, Bagot M, Claudepierre P. Psoriasis induced by tumor necrosis factor-alpha antagonist therapy: a case series. *J Rheumatol* 2007;**34**:380–5.

98. Roux CH, Brocq O, Leccia N, Giacchero D, Breuil V, Albert C, *et al.* New-onset psoriatic palmoplantar pustulosis following infliximab therapy: a class effect? *J Rheumatol* 2007;**34**:434–7.
99. Potter C, Hyrich KL, Tracey A, Lunt M, Plant D, Symmons DP, *et al.* Association of rheumatoid factor and anti-cyclic citrullinated peptide positivity, but not carriage of shared epitope or PTPN22 susceptibility variants, with anti-tumour necrosis factor response in rheumatoid arthritis. *Ann Rheum Dis* 2009;**68**:69–74. <http://dx.doi.org/10.1136/ard.2007.084715>
100. Navarro Coy NC, Brown S, Bosworth A, Davies CT, Emery P, Everett CC, *et al.* The ‘Switch’ study protocol: a randomised-controlled trial of switching to an alternative tumour-necrosis factor (TNF)-inhibitor drug or abatacept or rituximab in patients with rheumatoid arthritis who have failed an initial TNF-inhibitor drug. *BMC Musculoskelet Disord* 2014;**15**:452. <http://dx.doi.org/10.1186/1471-2474-15-452>
101. Ledingham J, Deighton C. Update on the British Society for Rheumatology guidelines for prescribing TNFalpha blockers in adults with rheumatoid arthritis (update of previous guidelines of April 2001). *Rheumatology* 2005;**44**:157–63. <https://doi.org/10.1093/rheumatology/keh464>
102. The Criteria Committee of the New York Heart Association. *Nomenclature and Criteria for Diagnosis of Diseases of the Heart and Great Vessels*. 9th edn. Boston, MA: Little, Brown & Co; 1994. pp. 253–6.
103. Prevoo ML, van ‘t Hof MA, Kuper HH, van Leeuwen MA, van de Putte LB, van Riel PL. Modified disease activity scores that include twenty-eight-joint counts. Development and validation in a prospective longitudinal study of patients with rheumatoid arthritis. *Arthritis Rheum* 1995;**38**:44–8. <https://doi.org/10.1002/art.1780380107>
104. Anderson JK, Zimmerman L, Caplan L, Michaud K. Measures of rheumatoid arthritis disease activity: Patient (PtGA) and Provider (PrGA) Global Assessment of Disease Activity, Disease Activity Score (DAS) and Disease Activity Score with 28-Joint Counts (DAS28), Simplified Disease Activity Index (SDAI), Clinical Disease Activity Index (CDAI), Patient Activity Score (PAS) and Patient Activity Score-II (PASII), Routine Assessment of Patient Index Data (RAPID), Rheumatoid Arthritis Disease Activity Index (RADAI) and Rheumatoid Arthritis Disease Activity Index-5 (RADAI-5), Chronic Arthritis Systemic Index (CASI), Patient-Based Disease Activity Score With ESR (PDAS1) and Patient-Based Disease Activity Score without ESR (PDAS2), and Mean Overall Index for Rheumatoid Arthritis (MOI-RA). *Arthritis Care Res (Hoboken)* 2011;**63**(Suppl. 11):14–36. <http://dx.doi.org/10.1002/acr.20621>
105. Felson DT, Anderson JJ, Boers M, Bombardier C, Chernoff M, Fried B, *et al.* The American College of Rheumatology preliminary core set of disease activity measures for rheumatoid arthritis clinical trials. The Committee on Outcome Measures in Rheumatoid Arthritis Clinical Trials. *Arthritis Rheum* 1993;**36**:729–40. <https://doi.org/10.1002/art.1780360601>
106. Aletaha D, Nell VP, Stamm T, Uffmann M, Pflugbeil S, Machold K, *et al.* Acute phase reactants add little to composite disease activity indices for rheumatoid arthritis: validation of a clinical activity score. *Arthritis Res Ther* 2005;**7**:R796–806. <http://dx.doi.org/10.1186/ar1740>
107. Smolen JS, Breedveld FC, Schiff MH, Kalden JR, Emery P, Eberl G, *et al.* A simplified disease activity index for rheumatoid arthritis for use in clinical practice. *Rheumatology* 2003;**42**:244–57. <https://doi.org/10.1093/rheumatology/keg072>
108. Bykerk VP, Massarotti EM. The new ACR/EULAR remission criteria: rationale for developing new criteria for remission. *Rheumatology* 2012;**51**(Suppl. 6):vi16–20. <http://dx.doi.org/10.1093/rheumatology/kes281>
109. Fuchs HA, Pincus T. Reduced joint counts in controlled clinical trials in rheumatoid arthritis. *Arthritis Rheum* 1994;**37**:470–5. <https://doi.org/10.1002/art.1780370406>

110. Prevoo ML, van Riel PL, van 't Hof MA, van Rijswijk MH, van Leeuwen MA, Kuper HH, van de Putte LB. Validity and reliability of joint indices. A longitudinal study in patients with recent onset rheumatoid arthritis. *Br J Rheumatol* 1993;**32**:589–94. <https://doi.org/10.1093/rheumatology/32.7.589>
111. Smolen JS, Breedveld FC, Eberl G, Jones I, Leeming M, Wylie GL, Kirkpatrick J. Validity and reliability of the twenty-eight-joint count for the assessment of rheumatoid arthritis activity. *Arthritis Rheum* 1995;**38**:38–43. <https://doi.org/10.1002/art.1780380106>
112. Pincus T, Summey JA, Soraci SA, Wallston KA, Hummon NP. Assessment of patient satisfaction in activities of daily living using a modified Stanford health assessment questionnaire. *Arthritis Rheum* 1983;**26**:1346–53. <http://dx.doi.org/10.1002/art.1780261107>
113. Zigmond AS, Snaith RP. The hospital anxiety and depression scale. *Acta Psychiatr Scand* 1983;**67**:361–70. <https://doi.org/10.1111/j.1600-0447.1983.tb09716.x>
114. de Jong Z, van der Heijde D, McKenna SP, Whalley D. The reliability and construct validity of the RAQoL: a rheumatoid arthritis-specific quality of life instrument. *Br J Rheumatol* 1997;**36**:878–83. <https://doi.org/10.1093/rheumatology/36.8.878>
115. O'Keefe DJ. Colloquy: Should familywise alpha be adjusted? *Hum Comm Res* 2003;**29**:431–47. <https://doi.org/10.1111/j.1468-2958.2003.tb00846.x>
116. Proschan MA, Follmann DA. Multiple comparisons with control in a single experiment versus separate experiments: why do we feel differently? *Am Stat* 1995;**49**:144–9. <https://doi.org/10.1080/00031305.1995.10476132>
117. van der Maas A, Lie E, Christensen R, Choy E, de Man YA, van Riel P, *et al.* Construct and criterion validity of several proposed DAS28-based rheumatoid arthritis flare criteria: an OMERACT cohort validation study. *Ann Rheum Dis* 2013;**72**:1800–5. <https://doi.org/10.1136/annrheumdis-2012-202281>
118. Cohen JD. *Statistical Power Analysis for the Behavioral Sciences*. 2nd edn. Mahwah, NJ: Lawrence Erlbaum Associates; 1988.
119. White IR, Royston P, Wood AM. Multiple imputation using chained equations: Issues and guidance for practice. *Stat Med* 2011;**30**:377–99. <https://doi.org/10.1002/sim.4067>
120. Morris TP, White IR, Royston P. Tuning multiple imputation by predictive mean matching and local residual draws. *BMC Med Res Methodol* 2014;**14**:75. <http://dx.doi.org/10.1186/1471-2288-14-75>
121. Rubin DB. *Multiple Imputation for Nonresponse in Surveys*. New York, NY: Wiley; 1987. <https://doi.org/10.1002/9780470316696>
122. National Audit Office. *Services for People with Rheumatoid Arthritis*. London: The Stationery Office. 2009.
123. NICE. *Guide to the Methods of Technology Appraisal 2013*. London: NICE; 2013.
124. Glick HA, Doshi JA, Sonnad SS, Polsky D. *Economic Evaluation in Clinical Trials*. Oxford: Oxford University Press; 2014. <https://doi.org/10.1093/med/9780199685028.001.0001>
125. EuroQol Research Foundation. *How to Use EQ-5D*. 2016. URL: [www.euroqol.org/about-eq-5d/how-to-use-eq-5d.html](http://www.euroqol.org/about-eq-5d/how-to-use-eq-5d.html) (accessed February 2016).
126. Dolan P. Modeling valuations for EuroQol health states. *Medical Care* 1997;**35**:1095–108. <https://doi.org/10.1097/00005650-199711000-00002>
127. Curtis L, Burns A. *Unit Costs of Health and Social Care 2015*. Canterbury: PSSRU, University of Kent; 2015.
128. Department of Health (DH). *NHS Reference Costs 2014 to 2015*. London: DH; 2015.

129. Commercial Medicines Unit. *Drugs and Pharmaceutical Electronic Market Information (eMit)*. London: Commercial Medicines Unit, Department of Health; 2015.
130. Joint Formulary Committee. *British National Formulary (online)*. London: BMJ Group and Pharmaceutical Press. URL: [www.medicinescomplete.com](http://www.medicinescomplete.com) (accessed February 2016).
131. Campbell and Cochrane Economics Methods Group and the Evidence for Policy and Practice Information and Co-ordinating Centre. *CCEMG – EPPI-Centre Cost Converter*. 2014. URL: <http://eppi.ioe.ac.uk/costconversion/> (accessed January 2016).
132. Barton P, Jobanputra P, Wilson J, Bryan S, Burls A. The use of modelling to evaluate new drugs for patients with a chronic condition: the case of antibodies against tumour necrosis factor in rheumatoid arthritis. *Health Technol Assess* 2004;**8**(11). <https://doi.org/10.3310/hta8110>
133. Faria R, Gomes M, Epstein D, White IR. A guide to handling missing data in cost-effectiveness analysis conducted within randomised controlled trials. *Pharmacoeconomics* 2014;**32**:1157–70. <https://doi.org/10.1007/s40273-014-0193-3>
134. Rubin DB. *Multiple Imputation for Nonresponse in Surveys*. Hoboken, NJ: John Wiley & Sons; 2004.
135. Drummond MF, Sculpher MJ, Claxton K, Stoddart GL, Torrance GW. *Methods for the Economic Evaluation of Health Care Programmes*. Oxford: Oxford University Press; 2015.
136. Fenwick E, O'Brien BJ, Briggs A. Cost-effectiveness acceptability curves – facts, fallacies and frequently asked questions. *Health Economics* 2004;**13**:405–15. <http://dx.doi.org/10.1002/hec.903>
137. van Hout BA, Al MJ, Gordon GS, Rutten FF. Costs, effects and C/E-ratios alongside a clinical trial. *Health Econ* 1994;**3**:309–19. <https://doi.org/10.1002/hec.4730030505>
138. Briggs AH, Claxton K, Sculpher MJ. *Decision Modelling for Health Economic Evaluation*. Oxford: Oxford University Press; 2006.
139. Claxton K, Ginnelly L, Sculpher M, Philips Z, Palmer S. A pilot study on the use of decision theory and value of information analysis as part of the NHS Health Technology Assessment programme. *Health Technol Assess* 2004;**8**(31). <https://doi.org/10.3310/hta8310>
140. Edlin R, McCabe C, Hulme C, Hall P, Wright J. *Cost Effectiveness Modelling for Health Technology Assessment*. London: Springer; 2015. <https://doi.org/10.1007/978-3-319-15744-3>
141. National Rheumatoid Arthritis Society. *What is RA?* 2014. URL: [www.nras.org.uk/what-is-ra-article](http://www.nras.org.uk/what-is-ra-article) (accessed February 2016).
142. Porter D, van Melckebeke J, Dale J, Messow CM, McConnachie A, Walker A, et al. Tumour necrosis factor inhibition versus rituximab for patients with rheumatoid arthritis who require biological treatment (ORBIT): an open-label, randomised controlled, non-inferiority, trial. *Lancet* 2016. [https://doi.org/10.1016/S0140-6736\(16\)00380-9](https://doi.org/10.1016/S0140-6736(16)00380-9)
143. Tak PP. A personalized medicine approach to biologic treatment of rheumatoid arthritis: a preliminary treatment algorithm. *Rheumatology* 2012;**51**:600–9. <https://doi.org/10.1093/rheumatology/ker300>
144. Smolen JS, Aletaha D, Bijlsma JW, Breedveld FC, Boumpas D, Burmester G, et al. Treating rheumatoid arthritis to target: recommendations of an international task force. *Ann Rheum Dis* 2010;**69**:631–7. <http://dx.doi.org/10.1136/ard.2009.123919>
145. Gottenberg J, Brocq O, Perdriger A, Lassoued S, Berthelot JM, Wendling D. Therapeutic Strategy in patients with rheumatoid arthritis and insufficient response to a 1st anti-TNF: results of the multicenter randomized controlled 'ROC' Trial. [Abstract]. *Arthritis Rheum* 2013;**65**(Suppl. 10):1469.

146. D'Agostino RB, Massaro JM, Sullivan LM. Non-inferiority trials: design concepts and issues—the encounters of academic consultants in statistics. *Stat Med* 2003;**22**:169–86. <https://doi.org/10.1002/sim.1425>
147. Buch MH, Pavitt S, Parmar M, Emery P. Creative trial design in RA: optimizing patient outcomes. *Nat Rev Rheumatol* 2013;**9**:183–94. <http://dx.doi.org/10.1038/nrrheum.2013.5>
148. Curtis L. *Unit Costs of Health and Social Care 2014*. Canterbury: PSSRU; 2014.
149. Marshall JK, Blackhouse G, Goeree R, Brazier N, Irvine E, Assessment CCOHT. *Infliximab for the Treatment of Crohn's Disease: A Systematic Review and Cost–Utility Analysis*. Ottawa, ON: Canadian Coordinating Office for Health Technology Assessment (CCOHTA); 2002. Technology report no. 24.





# Appendix 1 Participant information sheet and consent forms



Delete this, then print first page of Information Sheet and Consent Form on Trust/Hospital headed paper

## SWITCH: Clinical Trial for Patients with Rheumatoid Arthritis who haven't benefited from an initial TNF-blocking drug.

### PARTICIPANT INFORMATION SHEET AND INFORMED CONSENT DOCUMENT

#### We invite you to take part in a research study called Switch

- Before you decide whether to take part, it is important for you to understand why the research is being done and what it will involve.
- Please take time to read the following information carefully. Discuss it with friends and relatives if you wish. Take time to decide whether or not you wish to take part.
- You are free to decide whether or not to take part in this research study. If you choose not to take part, this will not affect the care you get from your own doctors.
- Ask us if there is anything that is not clear or if you would like more information.
- Thank you for reading this information. If you decide to take part you will be given a copy of this information sheet and your signed consent form.

#### Important things that you need to know

- We want to find out the best treatment for those patients with rheumatoid arthritis who haven't benefited from an initial anti-TNF drug.
- We are comparing switching from one anti-TNF drug to another, or switching to abatacept or rituximab.
- This study has three groups or treatment options. Regardless of which treatment group you are in, you will receive treatment for a maximum of 48 weeks. After this, the treatment you receive will be decided by your doctor in line with national and local prescribing policy.
- The study fits into your normal treatment, so there are no extra hospital visits
- None of the drugs we are testing are new. They are all normally used to treat rheumatoid arthritis. However, we are trying to find out which one works best.
- As with any drugs, the drugs used in this study can have side effects. These are detailed in section 4. You can stop taking part in the study at any time, without giving a reason. Your treatment and care will not be affected in any way.

#### Contents

- 1 Why we are doing this study
- 2 Why am I being asked to take part?
- 3 What will happen to me if I take part?
- 4 Is it safe?
- 5 What are the benefits and disadvantages of taking part?
- 6 What happens to the information you collect about me?
- 7 What do I do if I have any concerns?
- 8 More information about taking part
- 9 Where can I get more information?

#### How to contact us

If you have any questions about this study, please talk to your doctor at:

<<Enter PI, nurse name>>  
<<contact details for site>>

## 1 Why we are doing this study

Rheumatoid arthritis (RA) is one of the most common treatable causes of disability in the Western world. Its symptoms impact heavily on people's ability to perform daily activities at home and ability to undertake work commitments. It is therefore vital to treat this condition effectively as soon as possible.

TNF-blocking (or anti-TNF) drugs have been proven highly effective in the treatment of RA, but some patients do not respond as well for reasons we do not yet fully understand. Initial studies have shown that when a TNF-blocking drug does not work, switching to one of the other TNF-blocking drugs may be effective.

In addition to TNF-blocking drugs, two drugs, rituximab and abatacept, have also been licensed for patients who don't benefit from a TNF-blocking drug. The National Institute for Health and Clinical Excellence (NICE), however, only allows use of rituximab (unless rituximab is contraindicated) which may not be appropriate in all patients. There have been no good studies comparing an alternative TNF-blocking drug or abatacept to rituximab in patients who don't benefit from an initial TNF-blocking drug.

Currently there is not enough evidence to guide clinicians on how best to use these therapies when a patient doesn't benefit from a first TNF-blocking drug.

This study will examine patients who don't benefit from their first TNF-blocker and are then randomised and switched to an alternative anti-TNF drug, abatacept or rituximab (which will be referred to as the standard treatment). The aim is to increase treatment options available to patients.

## 2 Why am I being asked to take part?

You are being asked to take part in this research study because you have RA and have already been taking an anti TNF-blocking drug. You have either not benefited from that or have lost the initial benefit you had from taking that particular anti TNF-blocking drug. The study is taking place in several other hospitals around the UK and we are hoping that 477 patients like you who have rheumatoid arthritis will take part.

## 3 What will happen to me if I take part?

First we need to make sure that it is safe for you to take part and that you are suitable for this study. To do this you will have some screening tests.

- **Screening:**

Screening may be carried out on the day you sign the consent form or you may be asked to return on a different day.

Your doctor may ask you questions about your medical history and medications you are currently taking. You will have a number of blood and urine tests, a heart trace (ECG), a chest X-ray and a full physical examination of some of your joints. You will also be asked to fill in a short questionnaire about your health.

If you are a woman, and capable of having children, a pregnancy test will be done to make sure you are not pregnant.

These tests are to make sure that it is safe for you to take the drugs in the study.

**If these tests show that it is not suitable or safe for you to take part in this study, your doctor will discuss other treatment options**

**with you. Any information we have collected about you will still be used but you will not continue on the study.**

- **Baseline:**

If your screening tests confirm that you are able to take part in the study, further blood tests will be carried out to measure how active your RA is before you start study treatment. You will also be examined thoroughly by your study doctor. You may have x-rays taken of your hands and feet and/or a bone density scan of your back. At this point we will also ask you to fill in some questionnaires.

- **Treatment visits (interventional phase):**

Visits to the hospital will depend on which treatment you are given. During these visits you will also be asked to complete some questionnaires and undergo some blood tests to monitor your disease in line with usual practice

- **Other visits**

As well as any treatment visits you will also be asked to attend your local hospital on a 12-weekly basis over a period of up to 96 weeks (a maximum of 8 occasions) to complete some more questionnaires and undergo further blood tests to monitor your disease, again, in line with usual practice. These visits will take 30-60 minutes. The actual number of visits you will be asked to attend will depend upon when you enter the study. This is because the study is scheduled to end in 2015 which will mean you are involved in the study for at least a minimum of 48 weeks or up to a maximum of 96 weeks.

### Everyone who takes part will get one of three treatments

The three different treatments are:

#### 1) Anti-TNF (one of a possible 5 drugs)

- **Infliximab**

You will receive intravenous infusions (drip) at the day unit/ward in your hospital. These will be given at weeks 0, 2, 6 and then every 2 months. Each intravenous infusion takes approximately 2 hours to administer.

- **Etanercept**

This is given as an injection under the skin every week. **Etanercept** may be delivered to your home by a home healthcare company as arranged by your hospital. Depending upon your hospital's arrangements, either your specialist nurse or someone from the home healthcare team will teach you how to inject. This may take more than one visit. You, your partner, or another member of your family can learn to give the injections.

- **Adalimumab**

This is given as an injection under the skin every 2 weeks. Adalimumab may be delivered to your home by a home healthcare company as arranged by your hospital. Depending upon your hospital's arrangements, either your specialist nurse or someone from the home healthcare team will teach you how to inject. This may take more than one visit to the hospital. You, your partner, or another member of your family can learn to give the injections.

- **Certolizumab pegol**

This is given as an injection under the skin at week 0 and then every 2 weeks. **Certolizumab pegol** may be delivered to your home by a home healthcare company as arranged by your hospital. Depending upon your hospital's arrangements, either your specialist nurse or someone from the home healthcare team will teach you how to inject. This may take more than one visit to the hospital. You, your partner, or another member of your family can learn to give the injections.

- **Golimumab**

This is given as an injection under the skin every 4 weeks. **Golimumab** may be delivered to your home by a home healthcare company as arranged by your hospital. Depending upon your hospital's arrangements, either your specialist nurse or someone from the home healthcare team will teach you how to inject. This may take more than one visit. You, your partner, or another member of your family can learn to give the injections.

## 2) **Abatacept**

**Abatacept** is given as an injection under the skin. These will be given at week 0 and then every week. Your specialist nurse will teach you how to inject **abatacept**. This may take more than one visit to the hospital. You, your partner, or another member of your family can learn to give the injections.

## 3) **Rituximab**

You will receive a total of 1 course of treatment for which you will need to attend the day unit/ward in your hospital. A course consists of 2 doses of rituximab given 2 weeks apart. A steroid injection is usually given first to reduce the risk of reactions to the intravenous infusion (drip). Each intravenous infusion (drip) takes approximately 6 hours to administer. Another course is given when the benefit starts to wear off. This would not be for least 6 months after the first course and in some can be a year or two.

If you are receiving one of the intravenous infusion treatments at your hospital you will undergo some safety checks to make sure it is safe for you to receive the drug and you will be asked how you have been feeling since we last saw you.

If you are receiving one of the treatments given as an injection at home, depending upon your hospital's arrangements, you may be asked to come in for a visit about 4 weeks after your treatment has started to check how you are getting on with your treatment.

### **What is the standard treatment?**

The standard treatment approved by NICE is rituximab. The other treatments being compared are also sometimes available to some patients but this varies from region to region.

### **How is it decided who gets which treatment?**

The best way of finding out whether a new treatment is as effective as standard treatment is in a randomised study. 'Randomised' means that a computer will allocate you randomly (as if by the roll of dice) to receive an alternative treatment. Neither your doctor nor you will choose which treatment you receive. In this way, a fair comparison can be made.

### **How long does treatment go on?**

If you benefit from the treatment, the drug will be continued for the duration of the 48 weeks/1 year study period (interventional phase). If you have been allocated to an anti-TNF drug or **abatacept**, you might not be able to continue this treatment after week 48 even if you have benefited from it. This would depend on your hospital policy. As mentioned earlier, rituximab is given as a single course and would be repeated if the benefit wears off.



### What are the drugs that are being used in this study?

TNF-blocking drugs work by preventing the excessive build-up of a protein called TNF (Tumour Necrosis Factor) that causes inflammation leading to pain, swelling and damage in the joints in RA. Most of them work by helping your immune system to attack the TNF but [etanercept](#) works by mopping up excess TNF.

[Abatacept](#) works by stopping some of the cells involved in causing inflammation from working together.

Rituximab sticks to and removes a type of cell that is involved in causing the inflammation in RA. Unfortunately some of these cells also make antibodies which are important proteins that the body uses to fight germs, viruses or anything else it sees as foreign or dangerous. However, these cells return after some months.

## 4 Is it safe?

### Unwanted effects of treatment

All the study treatments are approved and licensed for use.

Like the TNF-blocking drug you are already taking, all the drugs used in this study have effects on the immune system (the body's own [defense system](#)), and therefore may make you more likely to develop infections. You should tell your doctor or rheumatology nurse straight away if you develop symptoms of an infection such as a sore throat, fever or any other new symptoms or anything else that concerns you.

It is possible that there may be a slightly increased risk of certain types of cancer in patients using such drugs (although rituximab is used to treat a certain type of blood cancer). Such a link has not been proven but is the subject of current research. Please discuss this with your

doctor if you are concerned. TNF-blocking drugs have been associated with certain types of skin cancer – these can be readily treated when diagnosed early.

Very rarely, a potentially fatal side-effect called toxic epidermal necrolysis (TEN) that is a side-effect of any drug can occur in patients being treated with these drugs. This appears as a fever and then a rash, most commonly occurring in the mouth and eyes. If this were to occur, your doctor would stop your treatment with the drug thought to be making you ill.

**TNF-blocking drugs:** Very rarely, people taking TNF-blocking drugs may develop a condition called 'drug-induced lupus', which is usually mild. The symptoms are a rash, fever and increased joint pain. Your doctor will check for this with a blood test. If you develop drug-induced lupus, the TNF-blocking drug will be stopped and the condition usually then disappears.

**[Abatacept](#), [Etanercept](#), [Adalimumab](#), [Certolizumab](#) & [Golimumab](#):** These drugs are given as injections under the skin. Reactions at the injection site (e.g. redness, swelling or pain) may occur. These reactions are usually not serious.

**[Infliximab](#) & [Rituximab](#):** These drugs are given as an intravenous infusion (drip). A small proportion of people have had reactions to the intravenous infusion, with a fever, wheeziness, [rash](#) or fall in blood pressure. If you develop any symptoms during the intravenous infusion you should tell the person giving you the infusion straight away, because it may be necessary to slow the intravenous infusion down. Very rarely, reactions are severe enough to need to stop the treatment.

**Pregnancy during treatment, information for both women and men:** Some of the drugs listed above might harm an unborn baby; therefore you should not take part in this study if you are pregnant. You should not become pregnant or father a child during the study period or for a safety period as indicated by your study doctor after your last study dose.

You must therefore agree to use a reliable form of effective contraception during this time. Your doctor will discuss which methods of contraception are suitable. Combined oral contraceptive pills are often not recommended. If you are using this method of contraception, your doctor may recommend an alternative method, which could include the progesterone-only pill (or the mini pill).

Please note if, as a woman, you are taking hormonal contraceptives to prevent pregnancy you should be aware that herbal products containing St John's wort interact with hormonal contraceptives and can make these contraceptives less effective. This increases the risk of having an unplanned pregnancy. This applies to all hormonal contraceptives except intra-uterine devices. Please talk to your doctor if you have any questions and read the Patient Information Leaflet that comes with your hormonal contraceptive.

If you or your partner does become pregnant during the study, you must tell your study doctor at once who will advise you on the potential risks to your unborn child and the options available to you.

Once you have completed the study or if you withdraw from the study and you become pregnant during the specified safety period after your last dose of study drug, you should still tell your study doctor as soon as possible.

**X-rays:** During the study you will have a chest X-ray and, depending on the facilities available at your hospital, two X-rays of your hands and feet and a bone densitometry scan of your back and leg. These investigations will expose you to several small doses of ionising radiation. We are all constantly exposed to small amounts of ionising radiation in our daily lives due to natural background radiation in our environment. Rocks, building materials, food and drink, and cosmic radiation from space, all provide a radiation dose that we can't avoid. The small radiation dose from the examinations during your participation in this study will add a maximum of the same as about 10 days of natural background radiation.

For the X-ray and scan you will be asked to remove some of your clothes and to wear a gown. The chest X-ray will only be carried out at the start of the study (screening). The other tests, if available at your hospital, will be carried out before the start of study treatment (baseline) and at week 48 of the study.

---

## 5 What are the benefits and disadvantages of taking part?

---

All the study treatments are already approved and licensed for use but currently, only Rituximab is widely available.

The aim of this study is to compare the other treatments with the standard one in a large group of patients to see which ones give the best benefits to which groups of patients.

Taking part in this research study involves time and commitment such as regular hospital visits, although no more than if you were receiving these treatments outside of a research study setting. It is not expected that you will need to stay in hospital overnight, but occasionally this may be

necessary to treat any side effects. For your safety, your study doctor will monitor you throughout the study.

Not all patients respond in the same way to all treatments so we cannot guarantee that the treatment you receive will benefit you directly. However, the results from the study may improve treatments options for patients in the future.

---

## 6 What happens to the information you collect about me?

---

### Will my taking part be kept confidential?

If you decide to participate in SWITCH, the information collected about you will be handled strictly in accordance with the consent that you have given and also the 1998 Data Protection Act.

The information needed for study purposes will be collected on paper forms and sent (usually using standard Royal Mail post but in some cases by fax or email) from the hospital to the Clinical Trials Research Unit (CTRU). You will be allocated a study number, which will be used along with your date of birth and initials to identify you on each paper form. Your full name will be included on your consent form and a copy of this will be sent to the CTRU by fax or post. Every effort will be made to ensure that any further information about you that leaves the hospital will have your name and address removed so that you cannot be recognised from it; this information will usually be removed by a member of the study team at your hospital, but may also be removed by the CTRU upon receipt. Your data will be entered onto a secure database held at the CTRU in accordance with the 1998 Data Protection Act. Some of the information will also be sent to the Academic Unit of Health Economics (AUHE) which is also part of the University of Leeds, to

enable them to carry out their part of the research.

If you are allocated one of the drugs that may be delivered to you at home the home healthcare company will be given your name, address and possibly your telephone number to enable them to make deliveries to you. This would also be the case if your doctor prescribed you these drugs but you weren't taking part in SWITCH.

Your healthcare records may be looked at by ~~authorised~~ individuals from the research team, the University of Leeds (the study Sponsor), or the regulatory authorities to check that the study is being carried out correctly.

The information collected about you may be shared with other research teams to answer new research questions in the future. Your information will be ~~anonymised~~ (for example; your full name will not be disclosed).

Your data may be passed to other ~~organisations~~ (possibly in other countries where the data protection standards and laws are different to the UK) to monitor the safety of the treatment(s) that you are receiving; this data will have your name removed.

X-rays of hands and feet will be sent for central review to ensure that results / reports are consistent across hospitals. These will be sent via standard hospital processes (such as Royal Mail or courier). Wherever possible, this data will be ~~anonymised~~ and your name removed

### What will happen if I don't want to carry on with the study?

You may choose to withdraw from the study at any time, without giving a reason. Your decision will not affect the future medical care you receive. You should contact your doctor if you change your mind and decide that you no longer want to take part.

Your doctor may also decide that you are unable to continue in the study if:

- The results of certain tests show that you are not right for this study or for the study drug;
- You get any new health problems during the study;
- You get pregnant or decide that you want to become pregnant;
- The study doctor thinks it is in your best interest to stop

If, for any reason, during the study something happens that means you are no longer able to fully understand information you have been given about your treatment, your doctor will discuss any changes in your treatment with your family/ carer including whether you should be withdrawn from the study. In any event, the SWITCH team will continue to collect data from your clinical care team about your health and any further treatment you might receive until the end of the study at week 96.

If you decide to withdraw from the study, or if your doctor decides it is in your best interest to leave the study, you should give back all unused study medications.

All information collected about you up until your withdrawal will remain on file and will be included in the final analysis of the study. The SWITCH team will also continue to collect data about your health and any further treatment you might receive from your clinical care team until week 96. If you leave the study and do not wish for any further information to be collected about you for the SWITCH study, you should inform your clinical care team of this in order that no further follow-up information is collected from your medical records. However, please note the SWITCH team may be required to continue to collect some limited information about you in the

case of any side effects you may have as a result of taking part in the study. This will only be collected if required by the regulatory authorities.

In line with Good Clinical Practice guidelines, at the end of the study, your data will be securely archived for a minimum of 15 years.

Arrangements for confidential destruction will then be made.

### **What will happen to the results of the research study?**

When the study is complete the results will be published in a medical journal, but no individual participants will be identified. If you would like to obtain a copy of the published results, please ask your doctor.

## **7 What do I do if I have any concerns?**

### **What if the treatment doesn't help?**

If the treatment does not help, then, together with your rheumatologist, you may decide to withdraw your treatment but you will continue to be seen by your doctor so we can continue to collect information about what other treatment you might have and the usual assessments of your arthritis. In this case, your rheumatologist will discuss other available treatment options.

### **How is my condition monitored?**

Your arthritis will be monitored in a similar way to what you are used to. You will attend the hospital to see your rheumatologist every 3 months – as well as assessing your joints, you will have blood tests to measure the level of inflammation/disease activity as well as blood tests to ensure it is still safe for you to continue taking the drug.



### What happens when the research study stops?

At the end of the study your doctor will discuss available ongoing treatment options with you.

### What if there is a problem?

If a medical emergency related to your treatment for this study occurs while you are at home, you should initially try to contact the hospital where you received your treatment. If this is not possible you should go to the Accident and Emergency (A&E) department at your local hospital. If you are unable to get to the hospital you should contact your GP who will already have been informed of your participation in the study.

#### Harm:

Every care will be taken in the course of this clinical trial. However, in the unlikely event that you are injured as a result of the managing organisation (University of Leeds), compensation may be available and you may have to pay your related legal costs. Your hospital where you receive your treatment has a duty of care to you whether or not you agree to participate in the trial and the University of Leeds accepts no liability for negligence on the part of your hospital's employees. If you wish to complain about any aspect of the way you have been treated please contact your research doctor in the first instance.

Any claims will be subject to UK law and must be brought in the UK.

#### Complaints

If you remain unhappy and wish to complain formally, you can do this through the NHS complaints procedure (or Private Institution). Details can be obtained from your hospital. Alternatively, you may contact your local Patient Advisory Liaison Office.

If you have private medical insurance, you should tell your insurer that you are taking part in research. They will let you know if it affects your policy.

## 8 More information about taking part

### What if relevant new information becomes available?

Sometimes during the course of a study, new information becomes available. If this happens your doctor will tell you about it and discuss with you whether you want to continue in the study. If you decide not to continue in the study your doctor will continue your care. If you decide to continue in the study you may be asked to sign an updated consent form. Occasionally on receiving new information, your doctor may consider it to be in your best interest to withdraw you from the study.

### Who is organising and funding the research?

The SWITCH study is being organised by the University of Leeds through the Clinical Trials Research Unit (CTRU) in collaboration with the Section of Musculoskeletal Disease, Chapel Allerton Hospital, [Leeds](#). The study has been reviewed by the Leeds West Research Ethics Committee and the Research and Development Department situated at your hospital. The study is funded by National Institute for Health Research (NIHR) Health Technology Assessment (HTA) programme. Bristol Myers Squibb, a pharmaceutical company, are providing one of the drugs, [abatacept](#), free of charge.

### Who has reviewed the study?

To have obtained funding by the NIHR, the study had to go through review by experts who felt this study to be of relevance and importance to patients with rheumatoid arthritis today. It had also been discussed at the Arthritis Research UK Clinical Study Group with consensus that this study would be of significant value to the rheumatology community. The Data Monitoring Ethics Committee (DMEC) and Trial Steering Committee (TSC) will be supervising the study data on a regular basis.

### Involvement of the General Practitioner/Family Doctor (GP):

We would like to tell your GP that you are taking part in SWITCH and ask for your consent to do this, but otherwise all information about you and your treatment will remain confidential.

### What will happen to any samples I give?

Researchers at the local laboratories at your hospital will have access to your blood samples, which will be examined as part of the SWITCH study in accordance with this consent.

The samples will be labelled according to NHS standard practice and will not be anonymised, so that the results can be fed back to your doctor. The laboratories will handle your samples with the same duty of confidentiality as they would for any clinical sample. They will be retained at the end of the study as a record of the completed research study in order to verify the research results, if required.

### Additional research

Your samples and data may also be stored, and may provide a resource for future studies in the field of rheumatoid arthritis. If any information

from this study is used to develop new research, data protection regulations will be observed and strict confidentiality maintained; your data will have your personal details removed, but will be coded so it may be linked back to your details. You will not be identified in the results of future studies. Ethical approval will be obtained for any future studies involving your data or samples.

There is also the opportunity to donate tissue samples for future research. This involves having additional blood and urine samples taken before you start treatment and then again at weeks 12, 24, 36 and 48. If you wish to take part in the SWITCH Trial [BioBank](#) your doctor will provide you with a separate consent form and participant information sheet which are specific to this research. Participation in the additional research is entirely optional, and your decision to participate will not affect your participation in the rest of the study.

Your samples will **not** be used for commercial purposes.

### Will any genetic tests be done?

Genetic tests will not be performed in any of the samples you have provided for this study.

If you decide to take part in the additional SWITCH Trial [BioBank](#) project then genetic tests may be performed on your samples but this would be subject to appropriate approval from an ethics or scientific committee.

## 9 Where can I get more information?

If you have any further questions about your illness or clinical studies, please discuss them with your doctor. You may also find it helpful to contact National Rheumatoid Arthritis Society (NRAS), an independent charity ([freephone: \[REDACTED\]](#); [address: NRAS, Unit B4, Westacott](#)

Business Centre, Westacott Way, Littlewick Green, Maidenhead, Berkshire, SL6 3RT; website: [www.nras.org.uk](http://www.nras.org.uk) ).

If you would like further information about clinical research, the UK Clinical Research Collaboration (a partnership of organisations working together on clinical research in the UK) has published a booklet entitled 'Understanding Clinical Trials'. Contact UKCRC: Tel: [REDACTED]; website [www.ukcrc.org](http://www.ukcrc.org)

Another source of independent advice or support is the Patient Advisory Liaison Service (PALS). For more information on PALS or to find your nearest office visit their website at [www.pals.nhs.uk](http://www.pals.nhs.uk) or ask your doctor.

You may also like to visit the following website for information on biologic therapies in the treatment of rheumatoid arthritis (a booklet can be requested from NRAS):

[http://www.nras.org.uk/help\\_for\\_you/publications/publication\\_detail.aspx?id=a0B80000008XzmxEAC](http://www.nras.org.uk/help_for_you/publications/publication_detail.aspx?id=a0B80000008XzmxEAC)

### **Local organiser**

If you want further information about the study, contact your local organiser/doctor whose details are given on page 1

**Thank you for taking the time to consider taking part in this study.**





**Participant Questionnaire –  
Health and Social Care Use & Expenditure due to Rheumatoid Arthritis**

**USE OF HEALTH AND SOCIAL SERVICES**

1 Due to your rheumatoid arthritis, have you used any of the following **community based** health and social services in the **last three months**?

Type of service	Which service have you used since joining the study?	Total number of face to face contacts since joining the study:	Total number of contacts by telephone or email since joining the study:
GP, surgery visit	Yes <input type="checkbox"/> No <input type="checkbox"/>		
GP, home visit	Yes <input type="checkbox"/> No <input type="checkbox"/>		
District nurse, health visitor, or member of community health team	Yes <input type="checkbox"/> No <input type="checkbox"/>		
Social worker	Yes <input type="checkbox"/> No <input type="checkbox"/>		
Physiotherapist	Yes <input type="checkbox"/> No <input type="checkbox"/>		
Occupational therapist	Yes <input type="checkbox"/> No <input type="checkbox"/>		
Podiatrist	Yes <input type="checkbox"/> No <input type="checkbox"/>		
Counsellor	Yes <input type="checkbox"/> No <input type="checkbox"/>		
Psychiatrist or psychologist	Yes <input type="checkbox"/> No <input type="checkbox"/>		
Home help or care workers	Yes <input type="checkbox"/> No <input type="checkbox"/>		
Other (please specify): .....	Yes <input type="checkbox"/> No <input type="checkbox"/>		

## Page 2 of 6

2 Due to your rheumatoid arthritis, have you used any of the following hospital based or residential care services in the last three months?

Type of service	Which service have you used since joining the study?	Total number of days spent in hospital / residential or nursing home since joining the study:	Total number of visits since joining the study:
Hospital inpatient stay	Yes <input type="checkbox"/> No <input type="checkbox"/>		
Hospital day centre	Yes <input type="checkbox"/> No <input type="checkbox"/>		
Hospital outpatient clinic	Yes <input type="checkbox"/> No <input type="checkbox"/>		
Hospital accident and emergency department	Yes <input type="checkbox"/> No <input type="checkbox"/>		
Nursing home	Yes <input type="checkbox"/> No <input type="checkbox"/>		
Residential home	Yes <input type="checkbox"/> No <input type="checkbox"/>		

## TRAVEL COSTS AND ADDITIONAL EXPENDITURES

3 In the last three months how much do you think you have spent on travel due to the management of your rheumatoid arthritis?

Please tick this box if you believe you have not spent anything on travel

Type of service	Your spending on travel since joining the study (fares for public transport, taxis and car park fees) £'s	If you have used your own car, approximate number of miles travelled since joining the study
GP, surgery visit		
District nurse, health visitor or member of community health team		
Social worker		
Physiotherapy		
Occupational therapy		
Podiatrist		
Hospital		
Counsellor		
Psychiatrist or psychologist		
Other (please specify): .....		

## Page 3 of 6

**COSTS OF AIDS**

**4** Due to your rheumatoid arthritis have you used any special equipment or aids (for example, specialist footwear or adapted cutlery) to help with your everyday mobility and functioning **in the last three months**?

Yes  No

**4a** If you answered **yes** to question 4, who provided the equipment or aids?

Provided by social service	Yes <input type="checkbox"/>	No <input type="checkbox"/>
Borrowed from a friend / family	Yes <input type="checkbox"/>	No <input type="checkbox"/>
Bought by yourself	Yes <input type="checkbox"/>	No <input type="checkbox"/>
Provided by a voluntary organisation	Yes <input type="checkbox"/>	No <input type="checkbox"/>
Provided by hospital	Yes <input type="checkbox"/>	No <input type="checkbox"/>

**4b** Again, if you answered **yes** to question 4, please describe the type of equipment or aids you have used **in the last three months**, and the cost to you

	Type of aid	Cost to you (£s)
i.		
ii.		
iii.		
iv.		



## Page 4 of 6

**COSTS OF HOUSEHOLD HELP**

**5** Due to the problems caused by your rheumatoid arthritis have you had any help with household tasks **in the last three months**?

Yes  No

**5a** If you answered **yes** to question 5, who was the household help provided by?

Provided by social service	Yes <input type="checkbox"/>	No <input type="checkbox"/>
Borrowed from a friend / family	Yes <input type="checkbox"/>	No <input type="checkbox"/>
Provided by a voluntary organisation	Yes <input type="checkbox"/>	No <input type="checkbox"/>
Provided by a private organisation	Yes <input type="checkbox"/>	No <input type="checkbox"/>

**5b** If you have answered **yes** to question 5, please describe the nature of the household help (for example, friend, relative, professional cleaner) you have used **in the last three months**, and the cost to you

	Nature of household help	Cost to you (£s)
i.		
ii.		
iii.		
iv.		

**5b** If you have answered **yes** to question 5, please describe the nature of the household help (for example, friend, relative, professional cleaner) you have used **in the last three months**, and the cost to you

**5c** If help was provided by family/friends; did they take time off work?

Yes  No

How many days? ..... days

**COSTS OF HEALTH ACTIVITIES**

**6** In order to manage your rheumatoid arthritis have you engaged in any health activities, in or outside of the household (such as exercise classes, massages), **in the last three months?** Yes  No

**6a** If you answered **yes** to question 6, who was the health activity provided by?

Provided by social service	Yes <input type="checkbox"/>	No <input type="checkbox"/>
Provided by a private organisation	Yes <input type="checkbox"/>	No <input type="checkbox"/>
Provided by a local council	Yes <input type="checkbox"/>	No <input type="checkbox"/>
Provided by a friend/family	Yes <input type="checkbox"/>	No <input type="checkbox"/>
Conducted yourself	Yes <input type="checkbox"/>	No <input type="checkbox"/>
Provided by a voluntary organisation	Yes <input type="checkbox"/>	No <input type="checkbox"/>
Provided by hospital	Yes <input type="checkbox"/>	No <input type="checkbox"/>

**6b** If you have answered **yes** to question 6, please describe the type of health activity you have engaged in **in the last three months**, and the cost of the activity (excluding transport costs) to you (for example, costs of participation or of equipment).

	Type of health activity	Cost to you (£s)
i.		
ii.		
iii.		
iv.		

**MEDICINES OVER THE COUNTER**

**7** In the last three months, what medicines have you used as a result of your diagnosis and what was the cost?

	Description of item	Cost to you (£s)
i.		
ii.		
iii.		
iv.		

## Appendix 3 Study closure patient information sheet



Delete this, then print first page of Information Sheet and Consent Form on Trust/Hospital headed paper

### **SWITCH: Clinical Trial for Patients with Rheumatoid Arthritis who haven't benefited from an initial TNF-blocking drug.**

#### **IMPORTANT INFORMATION ABOUT THE FUTURE OF THE SWITCH CLINICAL TRIAL**

Dear SWITCH Study Participant,

Many thanks for your participation to date in the SWITCH study, a clinical trial comparing three types of drugs in the treatment of rheumatoid arthritis. We are writing to you today to update you on some recent developments in the study, explain why they have happened and explain how you will be affected.

At the end of 2014 the SWITCH study's funders (the National Institute for Health Research (NIHR) Health Technology Assessment (HTA) programme) came to a decision to withdraw their future funding for the study. The reason they made this difficult decision was simply because they could not justify the additional timeframe, and therefore resource, that would be needed to recruit all the participants to complete the study. It is important to highlight, that the decision was in no way made due to any concerns about the safety of the study; the study is still safe for all current participants to continue with. The decision was purely due to the difficulties in justifying additional finances needed to support finding enough participants including within an acceptable timeframe.

Unfortunately this means there will be some changes for those people taking part in the study.

The way you will be affected depends on whether you are still receiving treatment as part of the study:

#### **Participants who are still receiving their study treatment**

- **Treatment:**  
If you are still in the first 48 weeks of your treatment (the interventional phase), and you are still receiving the drug you were allocated at the time you joined the study then you will continue with your treatment as normal until week 48. As mentioned above, there are no safety concerns about the treatments and it is completely safe to carry on taking part in the study.

After week 48, you will continue to be treated according to your hospital's local policy. This is the same as was described in the original Participant Information Sheet you were given when you joined the study.

○ **Visits:**

You will still be asked to come to visits at your hospital every 12 weeks until you reach week 48 of your study treatment so we can continue to collect information about the study from you. It is still important that we collect as much information as possible about the people taking part and therefore it is important that you carry on taking your treatment and coming to the visits.

However, previously we would have asked you to carry on coming to clinical study visits after your study treatment had finished to continue collecting information about you for the SWITCH study. Instead, your doctor will decide how often you need to come to hospital visits. There will be no more information collected about you at these visits specifically for the SWITCH study.

Also, if for any reason you stop taking your study treatment before week 48, then you will no longer be required to provide information for the SWITCH study after 24 weeks (this is the time to undertake the primary study analysis); once again, your doctor will decide how often you need to come to hospital visits and what information needs collecting.

**Participants who have finished their study treatment**

- If you have already finished 48 weeks of study treatment then your next visit will be your last visit and we will not be asking you to come back for any more visits to collect information about you for the study. Instead, your doctor will decide how often you need to come to hospital visits and there will be no study information collected about you at these visits.

**Please note:** Regardless of whether or not you are still receiving your study treatment, you will still receive NHS care for the treatment of your Rheumatoid Arthritis; there will be no reduction in the standard of NHS care you will receive.

**X-rays and bone densitometry scans**

In addition, study participants at some hospitals were having x-rays of their hands and feet and bone densitometry scans of their back and legs (your research team will be able to discuss with you whether this applies to you as these parts of the study were optional and hospital sites had the choice to undertake them or not). Although the study will still use the information from the scans performed so far, no further scans will be performed for the study from this date forward.

- **What will happen to the results of the research study?**

Unfortunately, as there have been fewer participants recruited onto the study than we had planned we will not be able to draw significant conclusions as we intended. However the data is still important and useful: we will be able to look for potential patterns of how well the treatments work which will inform further research in this area. The Health Technologies Assessment programme will publish any outcomes from the study on their website. If you would like to obtain a copy of the published results, please ask your doctor. We may also be able to combine the results with those from other studies, in order to strengthen our findings. If your information is used in combination with other studies, your personal details will not be used to identify you.

We are very keen that you continue your participation in the study and allow us to collect information about you at your next visit and until the end of your study treatment (where relevant). However, if for any reason you should wish to withdraw from the study then please contact your doctor to discuss this.

If you have any questions about anything in this letter, please talk to your doctor at:

<<Enter PI, nurse name>>

<<contact details for site>>

**SWITCH: Clinical Trial for Patients with Rheumatoid Arthritis who haven't benefited from an initial TNF-blocking drug.**

Participant ID:	Initials:
Date of Birth:	NHS/Hospital Number:
EudraCT Number: 2010-023880-17	Principal Investigator:

**IMPORTANT INFORMATION ABOUT THE FUTURE OF THE SWITCH CLINICAL TRIAL**

We would like to thank you for your participation in the SWITCH trial and taking the time to read this letter.

We would be grateful if you could acknowledge receipt of the letter below.

I confirm that I have read and understand the information sheet above and have had the opportunity to ask questions.

I agree to a copy of this acknowledgement form being sent to the CTRU.

**Participant:**

Signature.....

Name (block capitals).....

Date.....

## Appendix 4 SWITCH study closure patient information Article for National Rheumatoid Arthritis Society web page and other relevant electronic forums

You may remember that last year we published details of a new clinical trial, called SWITCH, on our website and Facebook page, amongst other areas. This trial was designed to compare three types of drugs in the treatment of RA (abatacept, rituximab and TNF inhibitors).

We are sorry to say this trial will not be able to accept any new participants after all. The study recruited 122 of the 477 participants it was looking to recruit, but unfortunately the study's funders (the NIHR HTA programme) have had to withdraw their future funding for the study. The reason they made this difficult decision was simply because they could not justify the additional time frame and, therefore, the resource, that would be needed to recruit all the participants to complete the study.

The study organisers are very keen to stress to all the trial participants and anyone else taking the drugs being used in the study that the decision was in no way due to any concerns about the safety of the study; the study is still safe for all current participants to continue with. The decision was purely due to the difficulties in justifying additional finances needed to support finding enough participants including within an acceptable time frame. Unfortunately, without the full numbers of participants entered into the trial, the study team will be unable to reach the significant conclusions they have intended. However, they still hope to be able to look for potential patterns of how well the treatments work which will inform further research in this area, and possibly combine the results with those from other studies, in order to strengthen any findings.

All participants who were still being seen by the research teams will have been contacted to discuss their future treatment. However, if you were previously involved in the trial and have any further questions please contact the research team who were looking after you whilst you were on the study and they will be happy to answer any queries you might have.





## Appendix 5 Schedule of events for each treatment



Event	Study phase											
	Screening	Baseline	Interventional						Observational			
	Study week 0 (≤ -4 weeks)	Study week 0	Study week 2 <sup>a</sup> (+5 days)	Study week 12 <sup>a</sup>	Study week 24 <sup>a</sup>	Study week 26 <sup>a</sup> (+5 days)	Study week 36 <sup>a</sup>	Study week 48 <sup>a</sup>	Study week 60 <sup>a</sup>	Study week 72 <sup>a</sup>	Study week 84 <sup>a</sup>	Study week 96 <sup>a</sup>
Glucose and lipid profile		X			X			X				
Unplanned surgery details				X	X		X	X				
Concomitant medication	X	X	X	X	X	X	X	X	X	X	X	X
Physical examination and vital signs	X	X	X	X	X	X	X	X	X	X	X	X
28-joint count (TJC and SJC)	X	X		X	X		X	X	X	X	X	X
Patient Assessment of General Health VAS		X		X	X		X	X	X	X	X	X
Patient Global Assessment of Arthritis VAS	X	X		X	X		X	X	X	X	X	X
Patient Global Assessment of Pain VAS		X		X	X		X	X	X	X	X	X
Physician Global Assessment of Disease Activity VAS	X	X		X	X		X	X	X	X	X	X
Morning stiffness (minutes)	X	X		X	X		X	X	X	X	X	X
HAQ-DI		X		X	X		X	X	X	X	X	X
RAQoL		X		X	X		X	X				
HADS		X		X	X		X	X				
EQ-5D		X		X	X		X	X	X	X	X	X
Health Utilities Index		X		X	X		X	X	X	X	X	X
Health, social care use and expenditure				X	X		X	X				

continued

**TABLE 33** Schedule of events for rituximab (continued)

Event	Study phase											
	Screening	Baseline	Interventional						Observational			
	Study week 0 (≤ -4 weeks)	Study week 0	Study week 2 <sup>a</sup> (+5 days)	Study week 12 <sup>a</sup>	Study week 24 <sup>a</sup>	Study week 26 <sup>a</sup> (+5 days)	Study week 36 <sup>a</sup>	Study week 48 <sup>a</sup>	Study week 60 <sup>a</sup>	Study week 72 <sup>a</sup>	Study week 84 <sup>a</sup>	Study week 96 <sup>a</sup>
Inpatient/outpatient hospital form				X	X		X	X				
Dorsal-posterior radiography of hands and feet <sup>c</sup>		X						X				
Bone densitometry scan <sup>c</sup>		X						X				
Optional biobank samples		X	X <sup>d</sup>	X	X		X	X				
AEs		Monitor during trial treatment										

ANA, anti-nuclear antibody; dsDNA, double-stranded deoxyribonucleic acid; FBC, full blood count; LFT, liver function test; U&E, urea and electrolytes.

a When a time delay between randomisation and the first dose of protocol treatment occurs, this was accounted for when arranging the clinical assessment visits during the interventional (weeks 12, 24, 36 and 48) and the observational (weeks 60, 72, 84 and 96) phases of the study, that is, the week 12 visit should be scheduled 12 weeks after the participant's first dose of protocol treatment. So, for example, if a participant's first treatment was delayed by 4 weeks, then all subsequent clinical assessment visits were scheduled from the date of randomisation +4 weeks to ensure that all participants received equal drug exposure despite treatment delays.

b Assessments need be repeated only if they have not been performed in the 24 weeks prior to screening.

c These procedures are to be performed at sites with specialist facilities only. Assessments undertaken up to 6 months prior to baseline or 6 weeks after the baseline visit are permissible.

d Only 5 ml of serum to be collected at week 2.

TABLE 34 Schedule of events for infliximab

Event	Study phase																
	Screening		Baseline		Interventional								Observational				
	Study week 0 (≤ -4 weeks)	Study week 0	Study week 2 <sup>a</sup> (±2 days)	Study week 6 <sup>a</sup> (±2 days)	Study week 12 <sup>a</sup>	Study week 14 <sup>a</sup> (±1 week)	Study week 22 <sup>a</sup> (±1 week)	Study week 24 <sup>a</sup>	Study week 30 <sup>a</sup> (±1 week)	Study week 36 <sup>a</sup>	Study week 38 <sup>a</sup> (±1 week)	Study week 46 <sup>a</sup> (±1 week)	Study week 48 <sup>a</sup>	Study week 60 <sup>a</sup>	Study week 72 <sup>a</sup>	Study week 84 <sup>a</sup>	Study week 96 <sup>a</sup>
Assessment/ procedure																	
Study treatment: infliximab		X	X	X		X	X		X		X	X					
Informed consent and registration	X																
Inclusion/ exclusion	X																
Randomisation		X															
Demographic data	X																
Medical and recent surgical history	X																
Pregnancy test (urine)	X																
Chest radiography <sup>b</sup> and 12-lead ECG	X																
Hepatitis B and C screening	X																
TB screening <sup>b</sup>	X																
Urinalysis	X																
Immunoglobulins	X																
Serological test (RF, ACPA, ANA test and anti-dsDNA antibodies)	X												X				

continued

TABLE 34 Schedule of events for infliximab (continued)

Event	Study phase																
	Screening		Interventional											Observational			
	Study week 0 (≤ -4 weeks)	Study week 0	Study week 2 <sup>a</sup> (±2 days)	Study week 6 <sup>a</sup> (±2 days)	Study week 12 <sup>a</sup>	Study week 14 <sup>a</sup> (±1 week)	Study week 22 <sup>a</sup> (±1 week)	Study week 24 <sup>a</sup>	Study week 30 <sup>a</sup> (±1 week)	Study week 36 <sup>a</sup>	Study week 38 <sup>a</sup> (±1 week)	Study week 46 <sup>a</sup> (±1 week)	Study week 48 <sup>a</sup>	Study week 60 <sup>a</sup>	Study week 72 <sup>a</sup>	Study week 84 <sup>a</sup>	Study week 96 <sup>a</sup>
Haematology test (FBC); blood chemistry (U&E, LFT); and CRP and ESR	X	X	X	X	X	X	X	X	X	X	X	X	X	X	X	X	X
Glucose and lipid profile		X						X					X				
Unplanned surgery details					X			X		X			X				
Concomitant medication	X	X	X	X	X	X	X	X	X	X	X	X	X	X	X	X	X
Physical examination and vital signs	X	X	X	X	X	X	X	X	X	X	X	X	X	X	X	X	X
28-joint count (TJC and SJC)	X	X			X			X		X			X	X	X	X	X
Patient Assessment of General Health VAS		X			X			X		X			X	X	X	X	X
Patient Global Assessment of Arthritis VAS	X	X			X			X		X			X	X	X	X	X
Patient Global Assessment of Pain VAS		X			X			X		X			X	X	X	X	X
Physician Global Assessment of Disease Activity VAS	X	X			X			X		X			X	X	X	X	X
Morning stiffness (minutes)	X	X			X			X		X			X	X	X	X	X

Event	Study phase																
	Screening		Interventional										Observational				
	Study week 0 (≤ -4 weeks)	Study week 0	Study week 2 <sup>a</sup> (±2 days)	Study week 6 <sup>a</sup> (±2 days)	Study week 12 <sup>a</sup>	Study week 14 <sup>a</sup> (±1 week)	Study week 22 <sup>a</sup> (±1 week)	Study week 24 <sup>a</sup>	Study week 30 <sup>a</sup> (±1 week)	Study week 36 <sup>a</sup>	Study week 38 <sup>a</sup> (±1 week)	Study week 46 <sup>a</sup> (±1 week)	Study week 48 <sup>a</sup>	Study week 60 <sup>a</sup>	Study week 72 <sup>a</sup>	Study week 84 <sup>a</sup>	Study week 96 <sup>a</sup>
HAQ-DI		X			X			X		X			X	X	X	X	X
RAQoL		X			X			X		X			X				
HADS		X			X			X		X			X				
EQ-5D		X			X			X		X			X	X	X	X	X
Health Utilities Index		X			X			X		X			X	X	X	X	X
Health, social care use and expenditure					X			X		X			X				
Inpatient/outpatient hospital form					X			X		X			X				
Dorsal–posterior radiography of hands and feet <sup>c</sup>		X											X				
Bone densitometry scan <sup>c</sup>		X											X				
Optional biobank samples		X	X <sup>d</sup>		X			X		X			X				
AEs		Monitor during trial treatment															

ANA, anti-nuclear antibody; dsDNA, double-stranded deoxyribonucleic acid; FBC, full blood count; LFT, liver function test; U&E, urea and electrolytes.

a When a time delay between randomisation and the first dose of protocol treatment occurs, this was accounted for when arranging the clinical assessment visits during the interventional (weeks 12, 24, 36 and 48) and the observational (weeks 60, 72, 84 and 96) phases of the study, that is, the week 12 visit should be scheduled 12 weeks after the participant's first dose of protocol treatment. So, for example, if a participant's first treatment was delayed by 4 weeks, then all subsequent clinical assessment visits were scheduled from the date of randomisation +4 weeks to ensure that all participants receive equal drug exposure despite treatment delays.

b These procedures are to be performed at sites with specialist facilities only. Assessments undertaken up to 6 months prior to baseline or 6 weeks after the baseline visit are permissible.

c Only 5 ml of serum to be collected at week 2.

d Assessments need be repeated only if they have not been performed in the 24 weeks prior to screening.





Event	Study phase											
	Screening	Baseline	Interventional						Observational			
	Study week 0 (≤ -4 weeks)	Study week 0	Study week 2 <sup>a</sup>	Study week 4 safety visit <sup>a</sup>	Study week 12 <sup>a</sup>	Study week 24 <sup>a</sup>	Study week 36 <sup>a</sup>	Study week 48 <sup>a</sup>	Study week 60 <sup>a</sup>	Study week 72 <sup>a</sup>	Study week 84 <sup>a</sup>	Study week 96 <sup>a</sup>
Glucose and lipid profile		X				X		X				
Unplanned surgery details					X	X	X	X				
Concomitant medication	X	X		X	X	X	X	X	X	X	X	X
Physical examination and vital signs	X	X		X	X	X	X	X	X	X	X	X
28-joint count (TJC and SJC)	X	X		X	X	X	X	X	X	X	X	X
Patient Assessment of General Health VAS		X		X	X	X	X	X	X	X	X	X
Patient Global Assessment of Arthritis VAS	X	X		X	X	X	X	X	X	X	X	X
Patient Global Assessment of Pain VAS		X		X	X	X	X	X	X	X	X	X
Physician Global Assessment of Disease Activity VAS	X	X		X	X	X	X	X	X	X	X	X
Morning stiffness (minutes)	X	X		X	X	X	X	X	X	X	X	X
HAQ-DI		X		X	X	X	X	X	X	X	X	X
RAQoL		X		X	X	X	X					
HADS		X		X	X	X	X					
EQ-5D		X		X	X	X	X	X	X	X	X	X
Health Utilities Index		X		X	X	X	X	X	X	X	X	X
Health, social care use and expenditure				X	X	X	X					

continued

**TABLE 35** Schedule of events for subcutaneous treatments (*continued*)

Event	Study phase											
	Screening	Baseline	Interventional						Observational			
	Study week 0 (≤ -4 weeks)	Study week 0	Study week 2 <sup>a</sup>	Study week 4 safety visit <sup>a</sup>	Study week 12 <sup>a</sup>	Study week 24 <sup>a</sup>	Study week 36 <sup>a</sup>	Study week 48 <sup>a</sup>	Study week 60 <sup>a</sup>	Study week 72 <sup>a</sup>	Study week 84 <sup>a</sup>	Study week 96 <sup>a</sup>
Inpatient/outpatient hospital form					X	X	X	X				
Dorsal-posterior radiography of hands and feet <sup>c</sup>		X						X				
Bone densitometry scan <sup>c</sup>		X						X				
Optional biobank samples		X		X <sup>d</sup>	X	X	X	X				
AEs		Monitor during trial treatment										

ANA, anti-nuclear antibody; dsDNA, double-stranded deoxyribonucleic acid; FBC, full blood count; LFT, liver function test; U&E, urea and electrolytes.

a When a time delay between randomisation and the first dose of protocol treatment occurs, this was accounted for when arranging the clinical assessment visits during the interventional (weeks 12, 24, 36 and 48) and the observational (weeks 60, 72, 84 and 96) phases of the study, that is, the week 12 visit should be scheduled 12 weeks after the participant's first dose of protocol treatment. So, for example, if a participant's first treatment was delayed by 4 weeks, then all subsequent clinical assessment visits were scheduled from the date of randomisation +4 weeks to ensure that all participants receive equal drug exposure despite treatment delays.

b These procedures are to be performed at sites with specialist facilities only. Assessments undertaken up to 6 months prior to baseline or 6 weeks after the baseline visit are permissible.

c Only 5 ml of serum to be collected at week 2.

d Assessments need be repeated only if they have not been performed in the 24 weeks prior to screening.

## Appendix 6 Disease activity response categories

### BOX 1 Derivation of the DAS28

The DAS28 used for the primary end-point analysis is a composite measure of four items:

1. TJC: (range 0–28)
2. SJC: (range 0–28)
3. ESR: (range 0–99)
4. Patient-completed VAS of Global Assessment of Arthritis, to answer the question 'Considering all of the ways your arthritis has affected you, mark on the line below how you feel your arthritis is today' (VAS: range 'very well' = 0 mm – 'very poor' = 100 mm)

With these four items, the DAS28 is calculated in the following manner:

$$\text{DAS28} = (0.56 \times \sqrt{\text{TJC}}) + (0.28 \times \sqrt{\text{SJC}}) + (0.7 \times \log_e \text{ESR}) + (0.014 \times \text{VAS}(\text{mm})), \quad (11)$$

where  $\log_e$  is the natural logarithm function, and  $\sqrt{x}$  is the square root function.

**TABLE 36** DAS28 response categories

Response category	DAS28 values
High	> 5.1
Moderate	> 3.2 but $\leq$ 5.1
Low	> 2.6 but $\leq$ 3.2
Remission	$\leq$ 2.6

**TABLE 37** EULAR28 response criteria based on the Disease Activity Score

DAS28 values	DAS28 improvement since baseline		
	> 1.2	$\leq$ 1.2 and $\geq$ 0.6	< 0.6
$\leq$ 3.2	Good response		
> 3.2 but $\leq$ 5.1	Moderate response	Moderate response	
> 5.1			No response

**TABLE 38** Clinical Disease Activity Index disease activity states

Disease activity	CDAI values
High disease activity	< 22
Moderate disease activity	> 10 but ≤ 22
Low disease activity	> 2.8 but ≤ 10
Remission	≥ 0 but ≤ 2.8

**TABLE 39** Simplified Disease Activity Index disease activity states

Disease activity	SDAI values
High disease activity	< 26
Moderate disease activity	> 11 but ≤ 26
Low disease activity	> 3.3 but ≤ 11
Remission	≥ 0 but ≤ 3.3

## Appendix 7 Statistical analysis plan

# Clinical Trials Research Unit (CTRU) University of Leeds

## Statistical Analysis Plan

### SWITCH

**Version 1.0**

**4th November 2015**

Trial Statistician:

Supervising Trial Statistician:

Study Scientific Lead

Project Delivery Lead

Senior Trial Co-ordinator:

Data Manager:

Chief Investigator:

Colin Everett

Sarah Brown

Linda Sharples

Catherine Fernandez

Claire Davies

Catherine Reynolds

Maya Buch

## Glossary

ABT	Abatacept. One of the study drugs in the SWITCH study.
ACPA	Anti-Citrullinated Peptide Antibody – the assay that detects presence of anti-CCP
ACR	American College of Rheumatology
ADA	Adalimumab. One of the allowable monoclonal antibody treatments under the SWITCH study
Anti-CCP	Anti-Cyclic Citrullinated Peptide.
Anti-TNF	See TNFi
Arthritis Research UK AIA CSG	Arthritis Research United Kingdom AIA Clinical Studies Group. An arthritis-related special interest group.
BSR	British Society for Rheumatology
CC	Complete Case (analysis). A patient with complete data for all fields required in the analysis.
CDAI	Clinical Disease Activity Index
CONSORT	Consolidated Standards of Reporting Trials. Refers to either the patient flow diagram, recommended by such guidance, or the guidance itself. See references (1,2) and Appendix A
CRF	Case Report Form
CRP	C-Reactive Protein. A measure of inflammation.
CTRU	Clinical Trials Research Unit, Leeds Institute of Clinical Trials Research, University of Leeds
CTZ	Certolizumab pegol. One of the allowable monoclonal antibody treatments under the SWITCH study
DAS28	Disease Activity Score with 28 joint counts. A composite outcome measure for patients with Rheumatoid Arthritis. (See Section 2.3 for definition)
DCF	Data Clarification Form
DMA	Data Management Assistant
DMARD	Disease-modifying Anti-Rheumatic Drug
DMEC	Data Monitoring and Ethics Committee
EQ5D	EuroQol 5-dimensions questionnaire.

ESR	Erythrocyte Sedimentation Rate. A measure of inflammation.
ETN	Etanercept. One of the possible alternative TNFi options in the SWITCH study.
EULAR	European League Against Rheumatism
GCP	Good Clinical Practice
GOL	Golimumab. One of the allowable monoclonal antibody treatments under the SWITCH study
HADS	Hospital Anxiety and Depression Scale. A Quality of Life questionnaire.
HAQ-DI	Health Assessment Questionnaire – Disability Index. A Quality of Life questionnaire.
HTA	Health Technology Assessment. The funding stream for the SWITCH study.
IB	Investigator Brochure
ICC	Intra-class correlation coefficient
IFX	Infliximab. One of the allowable monoclonal antibody treatments under the SWITCH study
ITT	Intention to Treat
IV	Intravenous
LDA	Low Disease Activity
MAB	Monoclonal Antibody. One of the possible alternative TNFi options in the SWITCH study
MAR	Missing At Random. The assumption that if a data item is missing, the “missingness” is not related to its underlying unobserved value once we account for the observed values of other variables in the imputation model.
MTX	Methotrexate. A required concomitant medication for patients in SWITCH.
NHS	National Health Service
NICE	National Institute for Health and Clinical Excellence
NSAID	Non-steroidal anti-inflammatory drug
NYHA	New York Heart Association

QoL	Quality of Life
RA	Rheumatoid Arthritis
RAQoL	Rheumatoid Arthritis Quality of Life. A Quality of Life Questionnaire
REFLEX	Rituximab for Rheumatoid Arthritis Refractory to Anti-Tumor Necrosis Factor Therapy. 2006 Phase III randomised controlled trial assessing the benefit of rituximab vs placebo in patients receiving methotrexate who failed their initial TNFi therapy. See reference (3).
RF	Rheumatoid Factor
RTX	Rituximab – One of the study drugs in the SWITCH study
SAS	Statistical Analysis Software. Cary NC, USA
SDAI	Simplified Disease Activity Index
SJC	Swollen Joint Count. The number of joints out of 28 that are swollen.
SmPC	Summary of Product Characteristics
SUSAR	Suspected Unexpected Serious Adverse Reaction
SWITCH	The present study. For protocol paper, see reference (4)
TB	Tuberculosis
TC	Trial Co-ordinator
TJC	Tender Joint Count. The number of joints out of 28 that are tender.
TMG	Trial Management Group
TNF (alpha)	Tumor Necrosis Factor (alpha). A biomarker indicative of inflammation.
TNFi	Tumor Necrosis Factor (alpha) Inhibitor. An agent that acts to reduce levels of this biomarker.
TSC	Trial Steering Committee
VAS	Visual Analogue Scale. A means of assessing a patient-reported outcome.
WCBP	Woman of Child Bearing Potential



## Box 1: Primary Endpoint: DAS28

$$DAS28 = 0.56 \times \sqrt{TJC} + 0.28 \times \sqrt{SJC} + 0.7 \times \log_e ESR + 0.014 \times VAS$$

Where:

TJC / SJC = Tender (or Swollen) Joint Counts

ESR = Erythrocyte Sedimentation Rate

VAS = Patient Completed Visual Analogue Scale Score of Global Assessment of Arthritis (mm)

## 1. Introduction

### 1.1 Background

Rheumatoid arthritis (RA) is one of the most common autoimmune diseases; a chronic, systemic, inflammatory arthritis, affecting over 600,000 people in the UK (5) and is the largest cause of treatable disability in the Western world (6,7). Patients suffer considerable pain, stiffness and swelling and if not adequately controlled, sustain various degrees of joint destruction, deformity, and significant functional decline. RA can occur at any age, but the peak time of onset is in the fourth and fifth decades of life, a time which coincides with i) highest earning potential for those in work, and ii) may also represent a significant transition phase in roles within the family -including dealing with adolescents moving toward independence at one end of the spectrum and likely increased dependence of elderly parents at the other end (8).

Given its high prevalence in the working population, the impact of RA represents a major individual and societal economic burden (9). The significant direct costs of hospitalisation, joint replacement surgery, drugs and social care are matched with equivalent indirect financial impact, through loss of employment. Expedient implementation of disease-modifying anti-rheumatic drug (DMARD) therapy is the cornerstone of management of RA. Nevertheless, it has become clear that poor response (even if initially effective) remains a feature with most DMARDs over time. In addition, a high incidence of toxicity has been observed with these drugs (10). Such obstacles to therapy combined with data suggesting limited alteration in long-term outcome even in those showing response has argued for more optimal therapy (11).

This unmet clinical need fuelled research into RA which led to significant advances in our understanding of RA by the 1990s; excess pro-inflammatory cytokines, in particular, TNF-alpha was shown to be critical in driving RA pathogenesis (12). Following in vitro and in vivo work, the most compelling evidence for a key role for TNF-alpha stemmed from studies where marked clinical benefit was observed in patients with RA treated with chimeric anti-TNF-alpha monoclonal antibodies (13).

### 1.1.1 TNF-Inhibitors

Cochrane reviews provide clear evidence that three currently licensed TNFi drugs (etanercept, infliximab and adalimumab) produce better outcomes in RA compared with placebo or treatment with conventional DMARDs (14). All these are in the same class of drug i.e. TNFi but differ in several respects, such as molecule type, target, binding affinity to TNFi, mechanism of action and method of administration.

Despite the extensive benefits of TNF-directed biologic therapies, a significant proportion of RA patients fail to achieve sufficient response (15). Two broad approaches can be employed to manage initial TNFi non-response; switching to an alternative TNFi therapy or use of another mechanism agent. Of the latter, rituximab, a B-cell depleting therapy and abatacept, another agent that targets T-cell co-stimulation are licensed, with rituximab also approved by National Institute of Health and Clinical Excellence (NICE) for the treatment of RA.

Tocilizumab, an interleukin-6 receptor monoclonal antibody, has also been recently licensed and approved by NICE following TNFi failure.

### 1.1.2 Switching between TNF-Inhibitors

Current NICE guidance does not permit switching to an alternative TNFi as a second-line biologic therapy choice. Several early phase, uncontrolled studies and an initial small randomised study suggested benefit in switching between TNFi agents (16-26). The rationale and argument for switching between different anti-TNF drugs was recently strengthened by a large, randomised industry-led efficacy study comparing Golimumab to Placebo in a Phase II study of 461 patients previously having failed or intolerant to 1 or more TNF-inhibitors (27). A key benefit of the TNFi is their suitability in both seropositive and seronegative disease (to rheumatoid factor (RF) +/- anti-citrullinated peptide antibody (ACPA)). This contrasts with the influence of antibody status and response rates in patients treated with rituximab due to its distinct target and rationale for use (rituximab depletes B-cells that produce antibodies; see below). It is important therefore not to prematurely discount an alternative TNFi drug as an effective therapeutic option, particularly in the context of such resistant and aggressive disease cohorts.

### 1.1.3 Alternative Biologic Therapies

Recently introduced alternative targeted biological therapies provide another option in the setting of TNFi failure. These include rituximab and abatacept. Industry-led efficacy studies have demonstrated benefits of both these therapies after TNFi failure (3, 28) although only rituximab is NICE-approved (and neither abatacept nor a TNF-antagonist has been compared to rituximab). Certain patients however will not be appropriate for rituximab (and may even lead to unpredictable responses/toxicity (29)) or will fail to respond (up to a third of patients). Furthermore, seronegative antibody status (seen in up to 25-30% of patients in this cohort) is associated with poorer response although this has not been formally tested (3, 30, 31). Abatacept's mechanism, like the TNFi therapies is associated with use in both seropositive and seronegative RA.

A recently published Swiss observational study (32) comprised 116 patients that had failed at least one TNFi agent that were either switched to an alternative TNFi therapy or to one cycle of rituximab with suggestion of rituximab a more favourable treatment option. Aside from including small numbers, this retrospective study had several other design limitations with outcome taken from differing time-points and inclusion of all types of initial TNFi failure; in addition it was neither controlled nor randomised to treatment type. We recently reported an interim observational analysis of patients switched to either an alternative TNFi or rituximab following failure of one/more TNFi therapies; this suggested equivalent clinical responses (33). Similar conclusions were drawn from another Swiss study (34). Notably, meta-analyses have failed to demonstrate superiority of one therapy over another (35), with European recommendations also confirming all as appropriate options (36).

Despite the benefits of recent advances in the management of RA, it is also apparent that no universally effective treatment exists. It remains unclear how best to utilise the alternative biological therapies described above following initial TNFi failure. The present approach is unsatisfactory, with clinicians treating patients in the absence of sufficiently strong data. The current reality, of 2nd-line biologic treatment restricted to a single option (rituximab) seriously impedes effective management. This is particularly pertinent to TNFi failure patients that have seronegative RA (up to 25-30% patients) for whom no NICE-approved options exist despite several more appropriate licensed therapies available and indeed other pathologies or disease characteristics that would argue for an alternative line of management. This poses a significant problem to the NHS and is in conflict with the patient agenda. Despite several treatment options now available, no

good quality head-to-head comparisons investigating the efficacy of sequential biologic treatments have been conducted to date.

In the re-design, 477 patients would be allocated on a 1:1:1 ratio to either rituximab (RTX), abatacept (ABT), or alternative TNFi (SWITCH). Within the alternative TNFi arm, a patient previously failing to respond to a monoclonal antibody will receive etanercept (ETN) and a patient failing to respond to etanercept will receive a monoclonal antibody (MAB) at the discretion of the treating clinician. Possible Monoclonal antibodies will include certolizumab (CTZ), golimumab (GOL), infliximab (IFX) or adalimumab (ADA). Following early trial closure, only 122 patients were randomised.

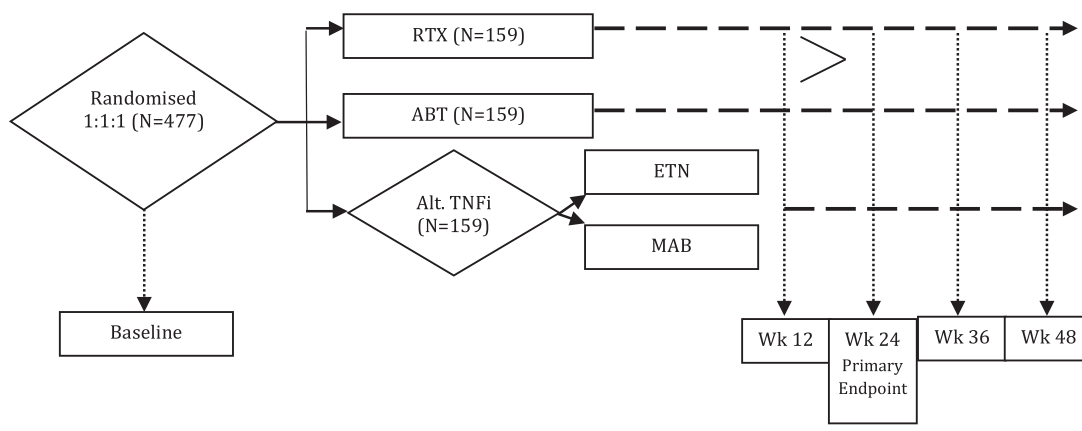

Figure 1: Brief trial design.

## 1.2 Design

### 1.2.1 Current Trial Design

SWITCH is a UK multi-centre, Phase IV 3-arm parallel group, randomised controlled trial. A total of 477 patients with Rheumatoid Arthritis, receiving Methotrexate and having failed to respond to initial TNFi therapy will be randomised to receive one of rituximab, abatacept, or alternative TNFi. Randomisation will be achieved using minimisation including a random element that will allocate patients on a 1:1:1 basis to the three treatment strategies. If a patient is allocated to the alternative TNFi arm, then the patient will receive either etanercept (if patient failed to respond to monoclonal antibody) or a monoclonal antibody (if the patient failed to respond to etanercept). (See Figure 1) The trial is open-label, since it would be unreasonable to administer multiple dummy injections and

infusions as a means to keep the patient blinded to their true allocation. The primary endpoint is absolute reduction in DAS28 over a period of 24 weeks.

### **1.2.2 Early closure of trial**

In November 2014, the HTA requested that the trial halt all further recruitment, and proceed with finishing follow-up for all randomised patients to a minimum of 48 weeks, and begin final analysis. The randomisation service closed to further recruitment with 122 patients randomised between 14<sup>th</sup> August 2012 and 18<sup>th</sup> December 2014.

## **1.3 Study aims and objectives**

The study aims and objectives listed here are as provided in the protocol. Following the early closure of the study, the focus of the analysis will be on estimating the treatment effect of either experimental arm compared to rituximab in terms of disease activity; it is considered unlikely that a conclusion of non-inferiority (or superiority) will be reached.

### **1.3.1 Primary objective**

To establish whether an alternative-mechanism-TNF-inhibitor (TNFi) or abatacept are non-inferior to rituximab in terms of disease response at 6 months (24 weeks) post randomisation.

### **1.3.2 Secondary objectives**

- To compare alternative-mechanism-TNFi and abatacept to rituximab in terms of disease response over a 12 month period (48 weeks).
- To compare alternative-mechanism-TNFi and abatacept to rituximab in terms of quality of life, toxicity and safety over a 12 month period (48 weeks).
- To undertake an evaluation of the cost-effectiveness/health economics of switching patients to an alternative-mechanism TNFi, abatacept or rituximab.
- To compare structural and bone density outcomes for abatacept and alternative-mechanism TNFi to rituximab over a 12 month period (48 weeks), in terms of bone densitometry score.

### 1.3.3 Exploratory Objectives:

- To determine the optimal sequence of treatments by assessing whether the response to the second treatment in RA patients is affected by which of the initial TNFi groups the patients failed (anti-TNF monoclonal or TNF receptor fusion protein).
- To evaluate whether the response to the second treatment (alternative mechanism TNFi, abatacept or rituximab) is affected by whether the patient was a primary (no initial response) or secondary (loss of an initial response) response failure to their initial TNF-blocking therapy.
- To ascertain whether seropositive and seronegative (to rheumatoid factor +/-anti-cyclic-citrullinated peptide antibody) RA patients behave differently in their response and disease outcome measures to the three treatment arms, particularly with respect to rituximab

## 1.4 Sample size and expected accrual

### 1.4.1 Current Trial Design

A total of 477 participants were to be recruited.

Each experimental trial arm (alternative mechanism TNFi, abatacept) will be compared to rituximab for non-inferiority in terms of change in DAS28 at 6 months. In the following justification, no adjustment for multiplicity of the comparisons of each experimental trial arm to rituximab has been made. Each of the comparisons can be interpreted independently; the comparison between abatacept and rituximab will provide no information on the comparison between alternative mechanism anti-TNF and rituximab. Multiple comparison procedures are therefore not required when testing two independent hypotheses (37, 38).

A total of 429 evaluable participants are required to have 80% power for demonstrating non-inferiority of either abatacept or alternative mechanism TNFi to rituximab at the 5% significance level. A total of 143 evaluable participants in each treatment group will ensure that the lower limit of the two-sided 95% confidence interval for the true difference in DAS28 (abatacept/alternative mechanism TNFi – rituximab) lies above -0.6 units, assuming no difference between treatment groups and a standard deviation between participants of 1.8 units (REFLEX trial (3)). Allowing for a loss to follow-up of 10%, a total of 477 participants will be recruited.

The proposed non-inferiority margin of -0.6 units in the change in DAS28 at 6 months corresponds to the maximum difference in DAS28 score that is considered to be of no clinical relevance and is the threshold for the clinical distinction of 'inferiority' (corresponds to the maximum change in DAS28 in participants with low or moderate disease activity that is classified as "no response" by the EULAR criteria). DAS28 score of 0.6 units is also the reported measurement error (39).

For the secondary outcomes analysis to compare quality of life, toxicity and safety at 6 months between treatment arms our sample size of 143 evaluable participants per group would enable us to detect a standardised effect size of 0.33 (small to medium by the definition of Cohen (40)), with 80% power and a 2-sided 5% significance level.

#### **1.4.2 Prior Trial Design**

Prior to implementation of Protocol V6.0, the target recruitment was 870 patients. This would allow the trial to conclude that either arm were non-inferior to rituximab in terms of the proportions of patients achieving a DAS28 reduction of 1.2 or more without toxicity, and also detect a significant interaction effect between seropositivity status and treatment effect. For details as to the assumptions and original choice of non-inferiority margin, refer to the SWITCH protocol paper (4).

#### **1.4.3 Planned Recruitment Rate**

In order to recruit 477 participants the target recruitment rate was 0.5 to 0.75 patients per month per centre over a maximum of 40 sites across the UK, over a maximum of 53 months.

#### **1.4.4 Final Recruitment**

The SWITCH trial closed to further recruitment in December 2014 with 122 patients randomised.

### **1.5 Randomisation**

Randomisation to one of the three study arms was performed centrally using the CTRU automated 24-hour telephone randomisation system. Authorisation codes, provided by the CTRU, were



required to access the randomisation system. These activities were performed by a member of the SWITCH research team.

Patients who gave written informed consent were first registered, and given a unique study ID number. Following completion of eligibility screening, patients who fulfilled the eligibility criteria were randomised to one of the three study arms.

Randomisations were achieved using minimisation incorporating a random element, via a computer program, that allocated patients in a 1:1:1 ratio between Alternative TNFi: Abatacept: Rituximab after taking account of the following factors, details of which will be required for randomisation:

- Randomising site
- Disease Duration (0 – 4 years, 5 or more years)
- Rheumatoid Factor / Anti-CCP status (Either seropositive, both seronegative)
- Pattern of TNFi non-response (Primary, Secondary)

After a randomisation is made to Alternative TNFi arm, the patient will be allocated to receive either Etanercept (if the previous TNFi failure was to a monoclonal antibody) or a monoclonal antibody (if the previous TNFi failure was to Etanercept). The treating clinician will choose the appropriate monoclonal antibody at his / her discretion.

In statistical analysis, underlined values will be taken as the reference category levels (estimating the effect of being eg Secondary Non-responder compared to Primary Non-Responder). Randomising Centre will not be fitted as a fixed effect in the analysis, so no reference category is required. See section 5.1.9, for how the random centre effect will be fitted.

## 1.6 Eligibility

Patients were required to satisfy the following criteria. Eligibility waivers to the inclusion / exclusion criteria were NOT permitted.

### 1.6.1 Inclusion Criteria

1. Male and female subjects aged  $\geq 18$  years at the time of signing the Informed Consent Form.

2. Patients with a diagnosis of rheumatoid arthritis as per the ACR/EULAR 2010 classification criteria confirmed at least 24 weeks prior to the screening visit.

3. Patients who have failed conventional DMARD therapy as per NICE/BSR Guidelines (41) i.e. failure of at least 2 DMARDS including MTX.

4. Patients with persistent RA disease activity despite having been treated with a current initial TNFi agent for at least 12 weeks. Active RA defined as\*:

- Primary non-response: failing to improve DAS28 by  $> 1.2$  or failing to achieve  $\text{DAS28} \leq 3.2$  within the first 12 to 24 weeks of starting the initial TNFi. This may include patients that have shown a reduction in DAS28 of  $> 1.2$  but still demonstrate unacceptably high disease activity in the physician's judgement with evidence of an overall DAS28 of  $\geq 3.2$

OR

- Secondary non-response: defined as inefficacy to first TNFi (having demonstrated prior satisfactory response) as per clinician judgement; with intolerance not the reason for cessation of first TNFi.

\*These criteria are consistent with BSR guidelines (41).

5. MTX dose stable for 4 weeks prior to the screening visit and to be continued for the duration of the study.

6. Patients on NSAIDs and / or corticosteroids (oral prednisolone not exceeding 10mg daily) who have been on an unchanged regimen for at least 4 weeks prior to the screening visit and are expected to remain on a stable dose until the baseline assessments have been completed.

7. Provided written informed consent prior to any trial-specific procedures.

## 1.6.2 Exclusion Criteria

### 1.6.2.1 General

1. Major surgery (including joint surgery) within 8 weeks prior to the screening visit or planned major surgery within 52 weeks following randomization.

### 1.6.2.2 Study Specific

2. Patients with inflammatory joint disease of different origin, mixed connective tissue disease, Reiter's syndrome, psoriatic arthritis, systemic lupus erythematosus, or any arthritis with onset prior to 16 years of age.
3. Patients receiving doses of prednisolone > 10mg/day within the 4 weeks prior to the screening visit.
4. Patients receiving intra-articular or intra-muscular steroid injections within 4 weeks prior to the screening visit.

### 1.6.2.3 Excluded Previous or Concomitant Therapy:

5. Patients who have previously received more than 1 TNFi drug OR any other biological therapy for the treatment of RA.
6. Patients unable or unwilling to stop treatment with a prohibited DMARD (i.e synthetic DMARD aside from MTX e.g. oral or injectable gold, chloroquine, hydroxychloroquine, cyclosporine, azathioprine, leflunomide, sulphasalazine) prior to the start of protocol treatment.
7. Treatment with any investigational drug in the last 12 weeks prior the start of protocol treatment.

### 1.6.2.4 Exclusions for general safety

These criteria should be considered in the context of BSR guidance (41).

8. Patients with other co-morbidity including acute, severe infections, uncontrolled diabetes, uncontrolled hypertension, unstable ischaemic heart disease, moderate/severe heart failure (Class III/IV of the New York Heart Association (NYHA) functional classification system (42)), active bowel disease, active peptic ulcer disease, recent stroke (within 12 weeks before the screening visit), or any other condition which, in the opinion of the investigator, would put the patient at risk to participate in the study or would make implementation of the protocol difficult.
9. Patients with any major episode of infection requiring hospitalisation or treatment with IV antibiotics within 12 weeks of start of treatment protocol or oral antibiotics within 4 weeks of start of protocol treatment.

10. Patients at significant risk of infection, which in the opinion of the investigator would put the patient at risk to participate in the study (e.g. leg ulceration, indwelling urinary catheter, septic joint within 52 weeks (or ever if prosthetic joint still in situ)).

11. Patients with known active current or history of recurrent bacterial, viral, fungal, mycobacterial or other infections including herpes zoster (for tuberculosis and Hepatitis B and C see below), but excluding fungal infections of nail beds as per clinical judgment.

12. Patients with untreated active current or latent tuberculosis (TB). Patients should have been screened for latent TB (as per BSR guidelines) within 24 weeks prior to the screening visit and, if positive, treated following local practice guidelines prior to the start of protocol treatment.

13. Patients with active current hepatitis B and/or C infection. Patients should have been screened for hepatitis B and C within 24 weeks prior to the screening visit and if positive, excluded from the study.

14. Primary or secondary immunodeficiency (history of or currently active) unless related to primary disease under investigation.

15. Pregnancy, lactation or women of child-bearing potential (WCBP) unwilling to use an effective birth control measure whilst receiving treatment and after the last dose of protocol treatment as indicated in the relevant SmPC/IB.

16. Men whose partners are of child-bearing potential but who are unwilling to use an effective birth control measure whilst receiving treatment and after the last dose of protocol treatment as indicated in the relevant SmPC/IB.

#### **1.6.2.5 Laboratory value exclusions**

17. Patients with known significantly impaired bone marrow function as for example significant anaemia, leukopaenia, neutropaenia or thrombocytopaenia as shown by the following laboratory values at the time of the screening visit:

- Haemoglobin < 8.5 g/dl
- Platelet count <  $100 \times 10^9 / L$
- White blood cell count <  $2.0 \times 10^9 / L$

- Neutrophil count  $< 1 \times 10^9 / L$

18. Patients with known severe hypoproteinaemia at the time of the screening visit, e.g. in nephrotic syndrome or impaired renal function, as shown by:

- Serum Creatinine  $> 150 \mu\text{mol} / L$

### 1.7 Planned analyses

No interim analyses will be undertaken prior to final analysis. One pre-specified interim analysis would have been conducted when 50% of patients had passed week 24, designed to allow for early stopping of an arm for demonstrating inferiority of either abatacept or alternative TNFi. With the closure of the trial before 25% of the expected patient numbers being recruited, the interim analysis is now obsolete.

The DMEC, in the light of the interim reports and of any advice or evidence requested, will if necessary report to the Trial Steering Committee (TSC) if there are concerns regarding the safety of the trial treatment.

## 2. Endpoints

The study endpoints are listed below. For definitions of endpoints (including references, where applicable) please see the endpoint definition sections 2.3 and 2.4.1 – 2.4.13.

### 2.1 Primary endpoint

The primary endpoint is the absolute change in DAS28 score (Disease Activity Score with 28 joint counts) between Baseline and Week 24.

### 2.2 Secondary endpoints

- DAS28 Score measured at Baseline, Week 12, Week 24, Week 36, Week 48.
- DAS28 “Response” at Week 12, Week 24, Week 36, Week 48.
- DAS28 Low Disease Activity at Baseline, Week 12, Week 24, Week 36, Week 48.
- DAS28 Remission at Baseline, Week 12, Week 24, Week 36, Week 48.
- EULAR Response Scores at Week 12, Week 24, Week 36, Week 48.

- EULAR / ACR Remission at Baseline, Week 12, Week 24, Week 36, Week 48.
- ACR Response Scores at Week 12, Week 24, Week 36, Week 48.
- CDAI Score at Baseline, Week 12, Week 24, Week 36, Week 48.
- SDAI Score at Baseline, Week 12, Week 24, Week 36, Week 48.

#### Quality of Life Endpoints

- RAQoL at Baseline, Week 12, Week 24, Week 36 and Week 48.
- HAQ-DI (also evaluated at weeks 60, 72, 84 and 96)
- HADS at Baseline, Week 12, Week 24, Week 36 and Week 48.
- Pain Visual Analogue Scale (also evaluated at weeks 60, 72, 84 and 96)
- General Health Visual Analogue Scale (also evaluated at weeks 60, 72, 84 and 96)
- Global Assessment of Arthritis Visual Analogue Scale (also evaluated at weeks 60, 72, 84 and 96)

#### Safety Endpoints (over 52 weeks)

- Toxicity
- Adverse Events

#### Economic Evaluation Endpoints

- EuroQol 5-dimensions (EQ-5DTM) (also evaluated at weeks 60, 72, 84 and 96)
- Health Utilities Index (also evaluated at weeks 60, 72, 84 and 96)
- Health and Social Care Use & Expenditure due to Rheumatoid Arthritis
- Incremental Cost Effectiveness

#### Imaging Endpoints

- Bone densitometry scan scores (T-scores unilateral neck of femur and lumbar spine-evaluated at baseline and week 48)

### 2.3 Primary endpoint definition

The DAS28 score to be used for the primary endpoint analysis is a composite measure of four items:

- Tender Joint Count (TJC: Range 0-28)
- Swollen Joint Count (SJC: Range 0-28)
- Erythrocyte Sedimentation Rate (ESR: Range 0-99)
- Patient-completed Visual Analogue Scale of Global Assessment of Arthritis, to answer the question “Considering all of the ways your arthritis has affected you, mark on the line below how you feel your arthritis is today” (VAS: Range “Very Well” = 0mm – “Very Poor” = 100mm)

With these four items, the DAS28 score is calculated in the following manner: (43,44)

$$DAS28 = (0.56 \times \sqrt{TJC}) + (0.28 \times \sqrt{SJC}) + (0.7 \times \log_e ESR) + (0.014 \times VAS(mm))$$

Where  $\text{LOG}_e$  is the natural logarithm function, and  $\sqrt{x}$  is the square root function.

Although other possible formulae exist for the DAS28 taking into account C-Reactive Protein (CRP) instead of ESR, or excluding ESR or CRP altogether, this is the definition of DAS28 that shall apply to the Primary Endpoint.

The Primary Endpoint is interpreted such that greater values indicate more active disease, and lower values indicate less active disease. Clinically relevant thresholds include Low Disease Activity (LDA) and Remission, both of which are defined in Section 2.4.2-2.4.3. EULAR disease response criteria consider the change from baseline as well as the present state, and are defined in Section 2.4.4.

For the Primary Endpoint Analysis, the absolute change from baseline in DAS28 shall be computed, by subtracting the follow-up value from the baseline value (see section 5.1.3). For this variable, positive values shall indicate worsening disease activity, and negative values shall indicate improving disease activity. Imputation of Missing Data items for the primary endpoint analysis is covered under section 2.6.1.

DAS28 can be categorised according to the value at a particular point in time as below:

Box 2 :DAS28 categories

High	$5.1 < \text{DAS28}$
Moderate	$3.2 < \text{DAS28} \leq 5.1$
Low	<b><math>2.6 &lt; \text{DAS28} \leq 3.2</math></b>
Remission	<b><math>\text{DAS28} \leq 2.6</math></b>

Values in bold relate to key secondary endpoints at sections 2.4.2 and 2.4.3.

If any of the four components of DAS28 are missing, then the DAS28 value will be missing. See section 2.6 for how missing data will be imputed.

## 2.4 Secondary endpoint definitions

### 2.4.1 DAS28 “Response”

A patient will be deemed to have achieved a “Response” to treatment in terms of DAS28 (see section 2.3) if they achieve a reduction in DAS28 from baseline of 1.2 units or more. If the patient does not achieve the required DAS28 reduction since baseline, the patient will be deemed to be a non-responder. If either the baseline or current values of DAS28 are not complete, then DAS28 “Response” will be missing. See section 2.6.1 for how missing data will be imputed.

### 2.4.2 DAS28 Low Disease Activity

A patient will be deemed to be in the state of Low Disease Activity (LDA) if at the assessment visit, their DAS28 score is in the interval (2.6, 3.2] (see section 2.3).



### 2.4.3 DAS28 Remission

A patient will be deemed to be in the state of Remission – both in terms of DAS28 (see section 2.3) and in terms of EULAR response – if at the assessment visit, their DAS28 score is 2.6 units or lower.

### 2.4.4 EULAR Response Criteria

European League Against Rheumatism (EULAR) Response criteria are determined according to the level of disease activity at the assessment, and by how much the DAS28 (see section 2.3) has improved since baseline. The diagram Box 3 illustrates how a patient is classified according to their Disease Activity and the improvement in disease activity.

A patient will be classed as having achieved No Response if:

- The DAS28 has reduced by less than 0.6 units (or has increased) since baseline, OR
- The DAS28 has reduced by between 0.6 and 1.2 units, and current DAS28 score is greater than 5.1 units.

A patient will be classed as having achieved Moderate Response if:

- The DAS28 has reduced by between 0.6 and 1.2 units, and current DAS28 score is 5.1 units or lower, OR
- The DAS28 has reduced by more than 1.2 units, and current DAS28 score is greater than 3.2 units.

A patient will be classed as having achieved Good Response if:

- The DAS28 has reduced by more than 1.2 units AND the current DAS28 score is 3.2 units or lower.

If the current DAS28 value, or the baseline value of DAS28 are not known, then the EULAR response level will be missing. See section 2.6 for how missing data will be imputed.

Box 3: EULAR response categories

Current DAS28 at endpoint	DAS28 IMPROVEMENT SINCE BASELINE		
	>1.2	$\leq 1.2$ and $\geq 0.6$	< 0.6
DAS28 $\leq 3.2$	<b>GOOD</b> Response	MODERATE Response	NO Response
3.2 < DAS28 $\leq 5.1$			
DAS28 > 5.1			

#### 2.4.5 ACR Response Criteria (ACR20 / ACR50 / ACR70)

The American College of Rheumatology (ACR) Response criteria are composite measures developed for rheumatoid arthritis. There are three criteria that can be achieved, referred to as ACR20, ACR50 and ACR70. To achieve an ACR20, participants must demonstrate a relative improvement (reduction) from baseline of at least 20% (or 50%/70% for ACR50/ACR70 respectively) in both tender and swollen joint counts and also a relative 20% (or 50%/70%) improvement in 3 out of 5 following criteria (45):

- Patient global health assessment of disease activity (measured by a Visual Analogue Scale (VAS))
- Physician global assessment of disease activity (Measured by a VAS)
- Patient assessment of pain (Measured by VAS)
- Patient assessment of physical function (Measured by HAQ-DI© questionnaire)
- Results of laboratory test for inflammatory marker (Either erythrocyte sedimentation rate (ESR) or C-Reactive Protein (CRP))

#### 2.4.6 ACR/EULAR Boolean remission rates (46)

Boolean remission is defined as swollen joint count (SJC), tender joint count (TJC), VAS patient global assessment (VAS) and CRP all  $\leq 1$ .

### 2.4.7 SDAI (Simplified Disease Activity Index) score (44, 47)

The components of SDAI are the number of tender joints (28 joint count), the number of swollen joints (28 joint count), the patient global disease activity (10cm VAS), the physician global disease assessment (10cm VAS) and CRP (mg/dl). Since the SWITCH study records Visual Analogue Scales in mm in a range of 0-100mm, the VAS scores will first be scaled by dividing by 10. (10 being the conversion factor between centimetres and millimetres) Similarly, the SWITCH study records CRP in mg/L, so this will first be converted by dividing by 10. The SDAI is defined as:

$$SDAI = TJC + SJC + \left(\frac{PtVAS(mm)}{10}\right) + \left(\frac{PhVAS(mm)}{10}\right) + \left(\frac{CRP(mg/L)}{10}\right)$$

#### Box 4: SDAI disease activity states

High Disease Activity	26 < SDAI
Moderate Disease Activity	11 < SDAI <= 26
Low Disease Activity	3.3 < SDAI <= 11
Remission	0 <= SDAI <= 3.3

### 2.4.8 CDAI (Clinical Disease Activity Index) score (44, 48)

The components of the CDAI are: the number of tender joints (28 joint count), the number of swollen joints (28 joint count), a Patient global assessment of arthritis (10 cm VAS) and physician global assessment of arthritis (10 cm VAS). These are added to provide an assessment of disease activity on a scale of 0-76. Since the SWITCH study records Visual Analogue Scale scores in mm in a range of 0-100mm, the scores will first be scaled by dividing by 10. The CDAI is defined as:

$$CDAI = SJC + TJC + \left(\frac{PtVAS(mm)}{10}\right) + \left(\frac{PhVAS(mm)}{10}\right)$$

#### Box 5: CDAI disease activity states

High Disease Activity	22 < CDAI
-----------------------	-----------

Moderate Disease Activity	$10 < \text{CDAI} \leq 22$
Low Disease Activity	$2.8 < \text{CDAI} \leq 10$
Remission	$0 \leq \text{CDAI} \leq 2.8$

#### 2.4.9 RAQoL (Rheumatoid Arthritis Quality of Life questionnaire) (49)

The RAQoL is a questionnaire that comprises 30 yes/no questions to which the patient responds. Each “Yes” scores 1 point. A fully-completed questionnaire is scored by summing the values gained for each question and takes a value in the range 0-30. Guidance is provided to deal with cases where a questionnaire is not fully-completed.

A summary of the scoring methodology is given in Appendix C.

#### 2.4.10 HADS (Hospital Anxiety and Depression Scale)

The HADS is a questionnaire that comprises 16 questions, each of which is answered by the patient and has 4 possible responses. The questions are scored to take values in the range of 0-3. Half of the question scores are then summed to produce an overall Anxiety scale, with the other half being summed to produce an overall Depression scale.

A summary of the scoring methodology for the HADS is given in Appendix E.

#### 2.4.11 HAQ-DI (Health Assessment Questionnaire – Disability Index)

The HAQ-DI is a questionnaire that comprises 24 questions, each of which is answered by the patient and has 4 possible responses. Questions relate to how much difficulty is experienced in undertaking certain activities, and whether any help or modified devices are required in order to complete them. The overall score is obtained from the average of 8 possible domains, each of which can take a value in the range of 0-3.

The HAQ-DI is a component of the ACR Response score. The HAQ-DI will need to be scored for all participants at all timepoints in order to compute the ACR response scores. A summary of the HAQ-DI scoring methodology is given in Appendix D.

#### **2.4.12 Economic Evaluation Endpoints**

The EQ-5D, Health Utilities Index, Health and Social Care Use and Expenditure due to Rheumatoid Arthritis and the Incremental Cost Effectiveness are endpoints of interest to the Health Economics Analysis. A separate plan will be written for such analysis, and the endpoints discussed in that document.

#### **2.4.13 Toxicity**

Toxicity is defined as the occurrence of an adverse event (including a serious adverse event, serious adverse reaction, adverse reaction, or SUSAR) that leads to permanent cessation of treatment.

### **2.5 Missing data**

Data management will focus on the consenting process, participant eligibility, safety, dates and assessment results that feed into the primary and key secondary endpoints. Attempts will be made to retrieve missing data on these areas via a thorough data cleaning process. Every effort will be made to obtain key data items, as specified in the key data items document, all key data will be 100% checked for quality and completeness by either the Data Management Assistant or Data Manager. See Data Monitoring, Section 4.1 for further details.

The levels of missing data and reasons for missingness will be investigated for the consenting process, participant eligibility, safety, dates and assessment results. The quantity of missing data will be monitored by treatment group, and a summary of the number of patients with missing primary endpoint data and the quantity of missing data by treatment group and centre will be reported.

### **2.6 Imputation of missing data**

Imputation of missing data under a model-based framework is limited by the expected number of observations at each timepoint. In order to account for both the longitudinal nature of the study, and the composite endpoints, it would be preferable to impute missing DAS28 and ACR Response components at all timepoints from baseline to week 48, and perform all imputations separately by

arm. However, since SWITCH did not recruit sufficient patients, such an imputation approach would require more observed patients at the final timepoint in each arm than were actually recruited. Accordingly, in order to satisfactorily impute data for the primary and key secondary endpoint analyses, DAS28 components will be imputed in a different framework to ACR Response components.

The decision to perform two separate approaches for the endpoints was taken to comply with three principles:

1. It is preferable to impute missing data separately within each treatment arm, rather than fitting a linear treatment covariate as a predictor. The former approach allows for the possibility of differential treatment modification effects for different components at different timepoints, while the latter approach does not.
2. The imputation model should, at a minimum reflect the analysis model. Accordingly, point (1) is important for the key secondary analysis of DAS28 values over time.
3. It is preferable to impute components separately, and then re-derive the composite endpoint than to directly impute the missing composite value. The latter approach ignores any known values that might contribute to the composite endpoint value.

The method of multiple imputation by chained equations (fully conditional specification) will be used to impute missing data for DAS28 components and ACR Response (50).

In each imputation, the missing value will be imputed in a model that includes the minimisation factors (excluding centre, owing to the large number of small centres) and the other components that make up the composite endpoint. The number of imputed datasets will be determined at analysis time, in the following manner:

1. In each model, the analysis dataset will be split into 3 parts, one for each treatment arm.
2. The percentage of missing values for each component at all timepoints will be determined in each arm.
3. The largest percentage of missing component-timepoint variables will be used to determine the number of imputations for that model.
4. The relevant percentage will be rounded up to the nearest whole percentage point, and one imputed dataset will be created for each percentage point of missingness indicated.

Thus, if the worst-completed variables in the three arms saw missingness as shown in Table 36:

Table 1: Example extent of missingness

Worst-completed components	TNFi missingness	Abatacept missingness	Rituximab missingness
TJC @48weeks	20.5%	0.6%	29.8%
SJC @48weeks	20.4%	15.8%	29.5%
ESR @48weeks	<b>30.1%</b>	15.7%	1.0%

Then 31 fully-imputed datasets will be created, regardless of the missingness of this value in other arms (50).

Since some of the components are unlikely to be normally distributed – even after transformation – and may even be discrete values (in the case of the joint counts), predictive mean matching will be used to impute the missing value following the imputation (one observation from the 3 closest values to the predicted value will be chosen). In balancing the risk of biased imputations (due to choosing from too many neighbouring observations) and unstable results (choosing from too few) we bear in mind that the imputations will effectively be performed in subsamples of 40-41 patients, rather than 122. Since small sample sizes bring a risk of sparse observed data points in the vicinity of the predicted mean value, we choose to sample from the 3 nearest observations, to reduce the chance of the selected observation being far from the predicted mean value (51).

The longitudinal nature of the DAS28 (and ACR response) data over 48 weeks poses challenges for missing data imputation. In order to allow for correlation between visits to be accounted for, the data will be restructured into a “flat-file” format. For DAS28, a patient will have 20 components to be imputed, rather than 4 at 5 timepoints (to week 48). For ACR Response, a patient will have 24 components to be imputed, rather than 8 at 3 timepoints (to week 24).

Once the missing data items have been multiply imputed, the DAS28 or ACR Response will be derived and the analysis performed on each multiply-imputed dataset. The resulting parameter

estimates will be combined using Rubin's Rules for Multiple Imputation. The resulting parameter estimates will form the primary endpoint analysis (50, 52).

Patterns of missing data will be explored between the treatment arms, and potential relations to baseline characteristics and timing of missing data will be explored.

### **2.6.1 Primary Endpoint Analysis Imputation – DAS28**

For the primary endpoint analysis of DAS28 reduction at 24 weeks and the key secondary endpoint analysis of DAS28 over a 48 week period, the components of the DAS28 (Tender and Swollen Joint Counts, ESR and Patient global assessment of arthritis) will be imputed if they are missing at any timepoint from baseline up to Week 48.

### **2.6.2 Secondary Endpoint analysis Imputation – ACR Response**

For the key secondary endpoint analysis (ACR20 Response at 24 weeks), the components of the ACR Response criteria (Tender and Swollen Joint Counts, ESR, CRP, Physician global assessment of arthritis, Patient Pain assessment and Patient global assessment of arthritis) will be imputed if they are missing at any timepoint from baseline up to Week 24.

### **2.6.3 Imputation models**

For each Imputation "effort", Multiple Imputation will be performed separately for each of the three treatment groups in isolation, rather than for the whole dataset incorporating a treatment group term. Missing values will be imputed in time order, starting with baseline values, then those at week 12, week 24, week 36 and finally week 48 in that order (for imputing ACR Response, imputations will cease after Week 24 values have been imputed). Within each visit timepoint, the missing values will be imputed in order from those with least missing data to those with most missing data.

To impute missing values for the (up to) 8 partially missing values at each timepoint, the multiple imputation procedure shall be invoked once, to impute all missing values required for that endpoint. Although we acknowledge that including additional variables in the imputation model can result in better imputed values and may make the Missing at Random assumption more plausible, we recognise that the expected small size of the dataset means that it would be infeasible to extend our



imputation models beyond that required for analysis. At the very least, we expect that our imputation models will match the analysis models.

#### **2.6.4 Sensitivity Analyses**

We will investigate the sensitivity of the conclusions to the Missing At Random Assumption by carrying out alternative methods of imputing missing DAS28 components, or scores:

A complete-case analysis (CC) will be performed, in which all participants missing at least one DAS28 component at Baseline or Week 24 will be completely excluded from the analysis. Such an analysis is not compatible with the Intention-to-Treat Analysis, and assumes that data is missing completely at random (MCAR). Differential non-completion may therefore result in biased treatment effect estimates.

### **3. Populations**

#### **3.1 Intention-to-treat population**

An intention-to-treat analysis will be the primary method for analysing and summarising the trial data. The intention-to-treat population is defined as all randomised patients, regardless of if they are ineligible, withdrawn, don't comply with the protocol, are lost to follow-up or don't receive any study treatment. Only patients who have withdrawn their consent for their data to be used in the study (ie they have requested that their data be destroyed) or for whom written informed consent has not been received, will not be included in this population. These patients will be analysed and summarised according to the treatment they were randomised to receive.

#### **3.2 Per protocol population**

In the per-protocol population, patients will be analysed according to the treatment received. The per-protocol population will exclude patients whose trial conduct constitutes a major protocol violation (see Appendix B). A list of such violations will be discussed and agreed by the Chief Investigator prior to analysis.

For non-inferiority analysis of the Primary Endpoint, a null hypothesis of inferiority rejected in the ITT analysis population must also be rejected in the Per-Protocol analysis population for the conclusion of non-inferiority to be held.

### **3.3 Safety population**

In the safety population, all participants will be included and safety data will be analysed according to the actual treatment received. If the patient is withdrawn from the study prior to receiving first dose of IMP, or the patient does not receive any IMP prior to completing the study, then the patient will be placed in a “Not received IMP” group, separate to the other possible treatment arms.

### **3.4 Quality of life populations**

A separate quality of life population will be formed for the analysis of each questionnaire. (RAQoL, HAQ-DI, HADS) Each population will comprise all patients who return an analysable baseline questionnaire, regardless of subsequent questionnaire completion.

### **3.5 Complete Case (CC) Analysis Population**

The CC analysis population will include all participants with all DAS28 components recorded at baseline and Week 24. Any patient missing any component at either visit will be excluded from this analysis population.

## **4. Data Handling**

Data will be monitored for quality and completeness by the CTRU in the following areas; consenting process, participant eligibility, safety, data consistency and assessment results. Missing data in these areas will be chased until it is received, confirmed as not available or the trial is at analysis. Any problems with data collection will be discussed at internal project team meetings and, if appropriate, external project team meetings. All efforts will be made to ensure that as much of the data is present as possible and that reasons are obtained when data is unobtainable.

The CTRU/Sponsor will reserve the right to intermittently conduct source data verification exercises on a sample of patients, which will be carried out by staff from the CTRU/Sponsor. Source data verification will involve direct access to patient notes at the participating hospital sites and the on-going central collection of copies of consent forms and other relevant investigation reports. A Trial Monitoring Plan has been developed which details the standard data and process monitoring performed for this trial being conducted by the CTRU.

An independent data monitoring and ethics committee (DMEC) reviewed the safety and ethics of the trial as described in Section 1.7. The DMEC, in the light of the interim reports and of any advice or evidence they wish to request, (including the extent to which treating clinicians / investigators are complying with the protocol) were able to - if necessary - report to the Trial Steering Committee (TSC) if there were concerns regarding the safety of the trial treatment.

The following were also to be examined continuously during the course of the trial:

- Consent
- Recruitment
- Randomisation
- Data quality/completeness (priority will be given to the key data items used to analyse the primary endpoint)
- Compliance with the protocol(e.g. eligibility, contraindicated medications)
- SAEs/SUSARs/Deaths/Pregnancies
- Withdrawals from the trial / losses to follow-up

#### **4.2 Data validation**

Data management will focus on the data associated with the consenting process, participant eligibility, safety, date consistency and assessment outcomes and this section refers to the cleaning of these items. The Data Management Assistant (DMA)/ Data Manager (DM) will carry out initial validation of the forms in accordance with the trial-specific Data Management Work Instructions. This will ensure that data is complete, consistent, and up-to-date. The Data Clarification Form (DCF) will be sent to sites to highlight missing data items and queries associated with data on CRFS that appears to have inaccurate/ inconsistent data recorded. Reasons should be obtained when data is unobtainable.

The database will validate most data in line with validation rules and highlight any issues that need further investigation i.e. with the site. Manual checks on all entered data will be performed prior to the validations being implemented. Data items collected relating to the safety and rights of individual patients are to be highlighted via priority validations and dealt with as a data management priority. Periodic batch validation will also be carried out to detect any data queries that may be missed if case record forms (CRFs) are entered in an order that does not allow real time validation checks to work.

A key data items list drawn up by the Trial Statistician that will include all data items that are required for the analysis of the primary endpoint. All key data items will be checked manually for completeness and accuracy by the DMA/TC, in addition to any automatic checks raised on the database. Data automatically generated through the 24-hour randomisation system will be checked by the Trial Statistician.

The Trial Statistician will also perform checks to identify any missing or inconsistent data and liaise with the Data Manager to resolve any queries.

The data will be validated and checked using SAS in the following steps:

- The data will be read into permanent SAS data sets.
- A random sample of 5 patients from each SAS dataset were checked against the data as seen on the database to ensure that the data transfer has been successful, until such time as the download process was accepted to be working. The names and contents of the variables can be found on the annotated final database specification reports in the Statistician's Trial File.

Data checks will include:-

- Eligibility checks
- Sequential dates
- Checks for unusual and outlying data
- Inconsistency in data between forms
- Checks for missing data (are there variables which are systematically missing/do specific variables have a large amount of missing data, particularly key outcome data)
- Other checks as deemed appropriate

Any inconsistent data will be noted and an e-mail sent to the data manager responsible for the study. A copy of this e-mail will be kept in the statistician's trial file. All queries will be resolved and the outcome documented.

## **5. Data Analysis**

### **5.1 General Principles**

Unless otherwise stated, the Alternative TNFi arm shall be summarised as a single "Alternative TNFi" arm for summarising. Within this arm, listings will report either etanercept or the particular monoclonal antibody allocated (or received). The two comparisons of interest are between rituximab and Alternative TNFi, and between rituximab and abatacept.

All percentages will be calculated using the total number of patients within the specified analysis population as the denominator (i.e. including all patients with missing data for that variable), percentages will be reported to 1 decimal place. All statistical tests will be 2-sided and performed at the 5% significance level. All analyses will be carried out using SAS. Where all participants are included in categorical summaries, but percentages do not exactly sum to 100% due to rounding, a footnote will be included to the effect that percentages do not sum to 100% due to rounding.

#### **5.1.1 Summary Statistics**

Where "summary statistics" are requested of continuous-scale data, the number of non-missing items, the means, standard deviations, medians, upper and lower quartiles and minima and maxima will be summarised to one more decimal place than the data are collected. Values that are below the limit of detection and therefore non-quantifiable will be summarised using the limit of quantification value. For listings, if required, the non-quantifiable value would be reported as an inequality and the limit of quantification value used would also be reported. For categorical values, the number of values will be reported, along with the percentage of the whole population represented. Percentages will be reported to 1 decimal place.

Exploratory analyses will use informal hypothesis testing. All analyses will be carried out using SAS 9.4 unless otherwise stated.

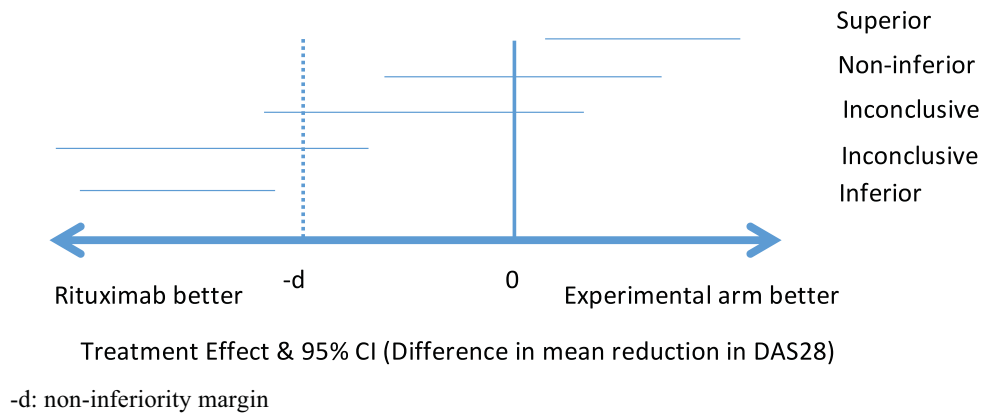

Figure 2: Summary of interpretation of non-inferiority conclusions, as described in the CONSORT statement extension for non-inferiority studies (2).

### 5.1.2 Non-inferiority Analyses

The primary endpoint analysis of the SWITCH study is to be performed on a non-inferiority basis. The treatment effect will be estimated as described, and a 2-sided 95% confidence interval for the effect will be formed. If the lower bound of this confidence interval is above the pre-specified non-inferiority margin, then the treatment will be deemed to be non-inferior to rituximab.

The pre-specified non-inferiority margin for the primary endpoint is 0.6units of DAS28. If the 2-sided 95% confidence interval for the treatment effect is wholly below -0.6 units, then the conclusion of inferiority will be reached. If said confidence interval lies wholly above the margin, then the conclusion of non-inferiority will be reached.

Non-inferiority will be assessed in both the ITT population, and in the Per-protocol population. A conclusion of non-inferiority must be confirmed in both populations for the study to reach the overall conclusion that an experimental arm is not inferior to rituximab. If a 2-sided 95% confidence interval lies wholly above the null value of 0 for the intention to treat population, then it will be possible for the trial to conclude that an experimental arm is superior to rituximab. Figure 2

above illustrates the interpretation of the results, with regard to the upper and lower confidence limits.

### 5.1.3 Absolute changes from baseline

The absolute change from baseline will be computed as the value at follow-up minus the value at baseline. If either value is missing, then the absolute change from baseline will be missing. A brief interpretation of positive or negative change values will be provided.

For example: if a patient's swollen joint counts (SJC) are 10 at baseline, and 12 at follow-up, this will be a change of 2. If the SJCs are 12 at baseline and 10 at follow-up this will be a change of -2.

### 5.1.4 Relative changes from baseline

Relative changes from baseline are defined as the absolute change divided by the baseline value. If the absolute change is missing, then the relative change will also be missing. A brief interpretation of positive or negative change values will be provided.

For example: if a patient's RAQoL Scores are 8 at baseline, and 16 at follow-up, this will be a relative change of 1.0. If the RAQoL scores are 16 at baseline and 8 at follow-up this will be a relative change of -0.5.

Where a baseline value of 0 is recorded, a relative change from baseline will not be derived. However, in deriving the ACR Response categories, we will bear in mind that, for a baseline value of 0, there is no possible reduction that can yield either 20, 50 or 70% reduction. If a patient with a zero baseline component value records an increase (ie positive absolute change or deterioration) in this value, then we will impute this as a non-response for the relevant ACR component response criterion. However, if the absolute change at follow-up is zero, resulting in an undefined division of 0/0, then this patient's component response will be left as a missing value.

### 5.1.5 Percentage change

Within this document and the subsequent results, the phrase “Percentage Change” will be understood to be a *relative* change, as defined in Section 5.1.4. Accordingly, relative change values will be multiplied by 100 in order to express the relative changes as percentage changes.

Where a variable is to be measured on a scale of 0-100%, and the absolute change from baseline in this variable is required, then the unit of difference will be expressed as “percentage points” or “%age points”, in order to differentiate from the phrase “Percentage Change”, which is defined as the *relative* changes.

Thus, if a variable takes a baseline value of 50% and a follow-up value of 25%, this will be described as a 50% reduction (since the value has reduced by a half) or a reduction of 25%age points. Likewise, a variable with a baseline value of 20% and follow-up value of 100% will be described as an increase of 80 percentage points, but a 400% increase (since the follow-up value is four times greater than that at baseline).

### 5.1.6 Confidence Intervals for proportions

Confidence intervals for a single proportion shall be calculated using Exact Clopper-Pearson intervals. (Method 5 of (53)) Confidence intervals for an absolute difference between independent proportions shall be calculated using Exact intervals. (Method 8 of (54))

This will not apply to proportions estimated via logistic regression methods: fitted values for odds and 95% confidence intervals will be estimated, and these will then be back-transformed to the [0,1] probability scale.

This will also not apply when combining multiple-imputed datasets using Rubin’s Rules. Instead, simple Wald-type confidence intervals will be used.

### 5.1.7 Randomisation errors

When handling the minimisation factors, patient data will be categorised as described for analysis. Where the data entered on the telephone randomisation system differs from any true values derived from baseline data, the corrected values resulting from the data cleaning process will be used for the primary analysis. Subgroup analyses will also use the corrected values. In addition to being the



principled approach, this will allow us to accommodate the change to the randomisation system where the balancing factor “RF status” was amended to “RF and ACPA status”.

#### **5.1.8 Non-mutually exclusive selections**

In summaries (for example of prior medical conditions, concomitant medication usage) where a single patient may reasonably have multiple responses selected, summaries will by default report only the values for each individual response level. No attempt will be made to enumerate a full list of all observed combinations unless specifically requested. Only particular pre-specified combinations of interest will be specified where appropriate. It will be assumed that a footnote to the effect of “These categories are not mutually exclusive” or “Patients may have multiple items selected” will be sufficient explanation for sums of percentages exceeding 100.

#### **5.1.9 Multivariable modelling**

Multivariable analyses will not be “built” following any model-fitting “strategy”. Instead, all variables specified for inclusion will be added to the model, and the significance of each factor will be reported. Where one categorical variable has more than one “factor level” then the significance of overall effect of including all factor levels will be tested, rather than those for each individual factor level. For all factor levels, suitable point and interval estimates of effect size will be presented.

Since we have two treatment comparisons of interest, our analysis will fit a single multivariable regression model, including the 3-level treatment variable. Then treatment contrasts will be formed, so as to compare the treatment effect of abatacept to rituximab, and to compare Alternative TNFi to rituximab.

Centre effects will be handled in accordance with Section 5.1.11.

#### **5.1.10 Reference levels for categorical fixed effects**

Where categorical variables are to be adjusted for in analyses, these shall use a pre-specified reference level. If the value is not pre-specified, then the modal value (ie the most frequently-

occurring) will be used. For the 3 minimisation factors that will be fixed effects, a pre-specified value will be used for the reference category (underlined in section S1.5).

For the treatment comparisons of interest, the reference category for the treatment effect will be rituximab.

#### **5.1.11 Centre Effects**

At the close of recruitment, 28 sites had randomised 122 patients. The median (and inter-quartile range) of by-centre recruitment was 3 patients (1-5), while 10 centres recruited between 1 and 2 patients in total. Owing to the large number of randomising centres with small numbers of patients, we will not attempt to fit a fixed effect for centre since a model fit is unlikely to converge: centre will be fitted as a random effect in the first instance. If an attempt to fit centre as a random effect fails to converge, then the centre will not be adjusted for in the analysis: centres will not be combined in any way so as to create a smaller number of larger pseudo-centres in order to allow the model fitting to converge and so randomising centre will be excluded from regression models. Where a decision is made to exclude a random centre effect from regression modelling, we will consider summaries that may support such a decision, including the intra-class correlation coefficient. (ICC)

#### **5.1.12 Simulation and re-sampling methods**

If any analysis requires the use of simulation and / or re-sampling methods, the initial “seed” value for the random number generation will be 20151902. The same seed will be used at the start of every such analysis.

#### **5.1.13 Longitudinal Analyses**

Analyses that model the effect of treatment over a period of time will be primarily be modelled as a random coefficients analysis as the primary analysis method, wherein the “time” effect will be directly calculated as the number of weeks since randomisation. A subsequent analysis for graphical purposes will use an alternative covariance-pattern model, in which the “time” effect is treated as a sequence of discrete timepoints, corresponding to the clinical assessment schedule. In

all such analyses, the baseline value will be fitted as a fixed effects covariate, rather than the first measurement at time  $t=0$ .

#### 5.1.14 Visual Analogue Scales

Visual Analogue Scale (VAS) scores are measured on a scale of 0-100mm, and are usually only considered valid when scales of 100mm are used. Where sites have locally reproduced CRFs, rather than relying on professionally-printed CRF booklets, these scales will typically not be 100mm long. Rather than consider these scales to be missing data, we will rescale the VAS scores by dividing the position of the response by the measured line length, and multiplying the result by 100mm.

Table 2 below illustrates the outcome of this rescaling:

Table 2: Rescaling of Visual Analogue Scales

Line length	Position of response (from leftmost extremity of scale)	Rescaled value
96mm	78mm	$100 * 78 / 96 = 81.25\text{mm}$
102mm	90mm	$100 * 90 / 102 = 88.2\dots\text{mm}$
94mm	(No mark)	Missing

## 5.2 Analysis

### 5.2.1 Baseline Characteristics

Summary statistics of baseline characteristics and pre-randomisation screening results will be presented by treatment arm and overall. Responses provided to questions during randomisation will be summarised. Where these differ from correct values provided on CRF, or derived values, these discrepancies will be listed.

## 5.2.2 Primary Endpoint Analysis

### *Primary Analysis*

The observed DAS28 values at baseline, at week 24, and the absolute changes from baseline will be summarised by the three treatment arms. (Summary statistics are specified in S5.1.1)

The treatment effect of each experimental arm compared to rituximab will be estimated by means of a linear regression model, modelling the absolute change from baseline at Week 24 as a function of the experimental arm, the duration of arthritis category, the category of non-response and for the Rheumatoid Factor / Anti CCP seropositivity status. These variables will be included as fixed effects, and shall be categorised as described in Section 1.5 and Section 5.1.10. In the first instance, an attempt will be made to fit the randomising centre as a random effect, since most of the randomising centres are most likely too small for a fixed effect for centre to be successfully fitted. If this model does not converge, then centre will not be included in the regression model. As mentioned in Section 5.1.11, we will not combine small centres in any way to create a small number of larger pseudo-centres so as to improve the fit of the regression model.

As mentioned in Section 5.1.9, we will form treatment contrasts for the 3-level treatment group variable to compare the treatment effects of Abatacept vs Rituximab and the treatment effects of Alternative TNFi vs rituximab.

After fitting the model in each of the multiple-imputed datasets, and the resulting parameter estimates combined, the parameter estimate for each fixed effect will be presented along with its 95% confidence interval and the 2-sided P-Value under the hypothesis that the true parameter estimate is equal to zero.

The adequacy of the linear regression model for the primary analysis will be assessed by examining the following:

- Distribution of standardised residuals by predicted values;
- Adequacy of Normal distribution for residuals;
- Examining values of leverage to identify influential points;
- Correlation between residual values and order of enrolment.

### *Exploratory Analyses*

There are 3 a-priori subgroup analyses planned. These are detailed in Section S5.3.1-S5.3.3. Within each treatment arm, patients will be subdivided as specified, and summary statistics reported within each subgroup.

#### **5.2.2.1 Sensitivity Analyses**

##### *Complete Case Analysis*

As detailed in Section 2.6.1, the primary endpoint will be analysed on a complete-case analysis basis: any participant missing at least one DAS28 component value at baseline or Week 24 will be excluded from the analysis.

#### **5.2.3 Key Secondary Endpoint Analysis**

Owing to the reduced level of recruitment and shortened trial timelines, a reduced amount of analysis will be conducted with respect to secondary endpoints.

##### **5.2.3.1 DAS28 “Response” (reduction of 1.2 units or more) at 12, 24, 36, 48 weeks**

The proportions of patients achieving this endpoint by arm at each timepoint will be summarised by treatment arm. (Summary statistics are specified in S5.1.1) After imputing missing values, the achievement of DAS28 “Response” will be analysed using a repeated measures random coefficients mixed effects logistic regression model, adjusting for the three minimisation factors (excluding centre) and baseline values of DAS28 (all modelled as fixed effects) and patient and patient by time effects (modelled as random effects) as well as time, randomised group and time by group interaction as fixed effects. Baseline values will be treated as a fixed effects covariate. It is not meaningful to include the baseline value as the first measurement at time  $t=0$ , since the DAS28 Response is based on change since baseline.

For graphical purposes, the mixed modelling analysis will also be performed using a covariance-pattern-type analysis, treating each visit as a sequence of discrete measurements, rather than a particular number of weeks.

### 5.2.3.2 DAS28 Score at 12, 24, 36, 48 weeks

Summary statistics of the DAS28 score will be presented at each timepoint by treatment arm. (Summary statistics are specified in S5.1.1) The DAS28 score will be analysed on a longitudinal analysis over the five visits from baseline to week 48. The values for the DAS28 components will be imputed as described, and the overall DAS28 score derived at each visit. Then, the values will be analysed using a random coefficients mixed effects linear regression model, adjusting for the three minimisation factors (excluding centre) and baseline value of DAS28 (all modelled as fixed effects) and patient and patient by time effects (modelled as random effects) as well as time, randomised group and time by group interaction as fixed effects. The baseline value will be treated as a fixed effect covariate, rather than the first measurement at time  $t=0$ . If attempts to fit a random effect for centre were not successful for the primary endpoint, then no attempt will be made to fit a random centre effect for this analysis.

For graphical purposes, the mixed modelling will be repeated as a covariance pattern-type analysis, treating the visits as separate discrete timepoints, rather than a number of weeks. Again, the baseline value will be treated as a fixed effects covariate, rather than the first measurement at time  $t=0$ .

### 5.2.3.3 ACR20 Response at Week 24

The proportions of participants achieving 20% reduction from baseline at week 24 in each of the ACR criteria will be summarised. (Summary statistics are specified in S5.1.1)

The binary variable ACR20 response at Week 24 will be analysed using a binary logistic regression model, adjusting for the 3 minimisation factors (excluding centre) all as fixed effects. If attempts to fit a random effect for centre were not successful for the primary endpoint, then no attempt will be made to fit a random centre effect for this analysis. If an attempt is made to fit a random centre effect in this analysis, and this is unsuccessful, the centre effect will not be included in the analysis. (See S5.1.11)

Once the model is fitted in each of the multiple-imputed datasets, and the resulting parameter estimates combined, the combined estimate of the odds ratio will be presented, along with its 95% confidence interval, and the 2-sided P-Value under the hypothesis that the Odds Ratio is 1.

## **5.2.4 Additional Secondary Endpoint Analyses**

### **5.2.4.1 HAQ-DI**

After scoring the HAQ-DI for all patients at all timepoints, summary statistics of the HAQ-DI at each timepoint will be presented by treatment arm and overall. (Summary statistics are specified in S5.1.1)

There will be no formal statistical analysis of this endpoint at any timepoint, as per the protocol Early Trial Termination Plan.

### **5.2.4.2 EULAR Response Scores**

The frequency and proportions of participants achieving each level of EULAR response (no, moderate, good) at each timepoint (weeks 12, 24, 36, 48) participants will now be summarised by treatment arm and overall. (Summary statistics are specified in S5.1.1)

There will be no formal statistical analysis of this endpoint at any timepoint, as per the protocol Early Trial Termination Plan.

### **5.2.4.3 DAS28 Low Disease Activity and Remission states.**

The frequency and proportions of participants achieving DAS28 Low Disease Activity and / or DAS28 Remission at each timepoint will be summarised by treatment arm and overall. (Summary statistics are specified in S5.1.1)

There will be no formal statistical analysis of this endpoint at any timepoint, as per the protocol Early Trial Termination Plan.

### **5.2.4.4 EULAR / ACR Remission**

The frequency and proportions of participants achieving the EULAR / ACR Remission criteria at each timepoint will be summarised by treatment arm and overall. (Summary statistics are specified in S5.1.1)

#### **5.2.4.5 ACR20, ACR50, ACR70 at Week 12, Week 24, Week 36 and Week 48**

ACR20 at 24 weeks is already covered under 5.2.3.3. For all other response criteria at all other timepoints, the frequency and proportions of patients who achieve the particular response level at each timepoint will be summarised by treatment group and overall. (Summary statistics are specified in S5.1.1)

With the exception of the analysis planned for the ACR20 at Week 24, (as described in S5.2.3.3) there will be no formal statistical analysis of this endpoint at any timepoint, as per the protocol Early Trial Termination Plan.

#### **5.2.4.6 Simplified Disease Activity Score**

Summary statistics of the SDAI score at all timepoints will be presented by treatment arm and overall. The frequency and proportions of participants in each category of SDAI score will be summarised by treatment arm and overall. (Summary statistics are specified in S5.1.1)

There will be no formal statistical analysis of this endpoint at any timepoint, as per the protocol Early Trial Termination Plan.

#### **5.2.4.7 Clinical Disease Activity Score**

Summary statistics of the CDAI score at all timepoints will be presented by treatment arm and overall. The frequency and proportions of participants in each category of CDAI score at each timepoint will be summarised by treatment arm and overall. (Summary statistics are specified in S5.1.1)

There will be no formal statistical analysis of this endpoint at any timepoint, as per the protocol Early Trial Termination Plan.



#### 5.2.4.8 RAQoL

It is recommended by the developers of the RAQoL that the score is treated only on an ordinal scale, and that summaries of the values are restricted to non-parametric statistics such as median, quartiles, minima and maxima.

Once scored, values of RAQoL will be summarised using non-parametric percentile-based summary statistics in each treatment group at each timepoint.

There will be no formal statistical analysis of this endpoint at any timepoint, as per the protocol Early Trial Termination Plan.

#### 5.2.4.9 HADS

The HADS will be scored at each timepoint for all participants, providing the Anxiety and Depression scales. Summary statistics of both the Anxiety and Depression scores will be presented by treatment arm and overall at each timepoint. (Summary statistics are specified in S5.1.1)

There will be no formal statistical analysis of this endpoint at any timepoint, as per the protocol Early Trial Termination Plan.

#### 5.2.4.10 Toxicity

The number of participants experiencing an adverse event leading to the permanent cessation of treatment will be summarised by arm. Within each arm, the timepoint at which treatment was permanently ceased will be summarised. Summaries will be presented based on both the ITT and Safety analysis populations. (Summary statistics are specified in S5.1.1)

#### 5.2.4.11 Safety – AEs / SAEs / SARs / SUSARs / Deaths / Pregnancies

Summaries of Safety Data will be performed on the Safety population. (See section 3.3)

Numbers of Adverse Events, Serious Adverse Events, Serious Adverse Reactions, Suspected Unexpected Serious Adverse Reactions, Deaths and Pregnancies will be summarised by each arm, with numbers of participants experiencing at least one such event. Line listings of SAEs, SARs and SUSARs will be presented. Line listings of reported deaths and Pregnancies will be presented. For

Adverse Events, summaries of the suspected causalities, intensities and outcome / subsequent cessation of treatment will be provided.

#### **5.2.4.12 Bone Densitometry**

Summary statistics of t-scores and z-scores for spine and neck of femur will be presented at Baseline and at Week 48. (Summary statistics are specified in S5.1.1)

### **5.3 Subgroup Analyses**

There are three a priori subgroup analyses planned, to investigate the possibility of a treatment modification effect on the primary endpoint. Any additional subgroup analyses will be deemed to be exploratory, and shall be described as such. Considering the small size of the study, with around 40 patients expected in each of the three arms, it is highly unlikely that any subgroup analyses will have sufficient power to make definitive conclusions as to any treatment modifying effect. No formal statistical analysis of subgroups will be performed. Owing to the reduced level of final recruitment, the amount of statistical analysis has been reduced to summary statistics. (Summary statistics are specified in S5.1.1)

#### **5.3.1 Modification effect of initial TNFi failure on treatment effect**

Summary statistics of change in DAS28 at 24 Weeks will be presented by treatment arm and overall. Within each treatment arm, the summaries will be presented by initial TNFi type.

#### **5.3.2 Modification effect of response failure type on treatment effect**

Summary statistics of change in DAS28 at 24 Weeks will be presented by treatment arm and overall. Within each treatment arm, the summaries will be presented by primary or secondary non-responder status.

### **5.3.3 Modification effect of Rheumatoid Factor (RF) / anti-cyclic-citrullinated peptide antibody (ACPA) seropositivity status on treatment effect**

Summary statistics of change in DAS28 at 24 Weeks will be presented by treatment arm and overall. Within each treatment arm, the summaries will be presented in two categories: being either RF / ACPA seropositive or being both RF / ACPA seronegative.

## **5.4 Additional Patient Summaries and Analyses**

### *Patient flow*

In line with the CONSORT guidelines for reporting randomised controlled trials (1) – including its extension to non-inferiority studies (2) – a flow diagram shall illustrate the flow of patients through the study, including the strategies to which they were assigned, the test strategies actually received and the subsequent management of the patients through to end of follow-up. The flow diagram will include the numbers of patients contributing to each analysis population.

The reasons for patients not being randomised in the study will be summarised. The dates on which the first and final patients were randomised will be reported, along with the date of final follow-up for the last patient.

### *Withdrawals and loss to follow-up*

The number of patient and PI withdrawals/loss to follow-up and reasons for these withdrawals will be summarised.

### *Protocol violators/deviations*

Protocol violations/deviations will be summarised overall, by treatment group and centre, including violations of eligibility criteria on entry into the trial, deviations from the treatment and assessment schedule.

## 5.5 Serious breaches of GCP

All serious and potential breaches of GCP that have occurred throughout the trial will be summarised by the Trial Co-ordinator and presented in the final report.

## 6. Reporting and Dissemination of the Results

The trial has been registered with ClinicalTrials.gov (NCT01295151)

### 6.1 Authorship and acknowledgement

The success of the study depends upon the collaboration of all participants. For this reason, credit for the main results will be given to all those who have collaborated in the study, through authorship and by contribution. Uniform requirements for authorship for manuscripts submitted to medical journals will guide authorship decisions. These state that authorship credit should be based only on substantial contribution to:

- conception and design, or acquisition of data, or analysis and interpretation of data
- drafting the article or revising it critically for important intellectual content
- final approval of the version to be published
- and that all these conditions must be met ([www.icmje.org](http://www.icmje.org)).

Main trial-related publication: The Chief Investigator, as having conceived the study, overseeing the study (unless any future change) with overall responsibility and being central in drafting the article and interpretation of data shall be first author on the main trial-related publication. Co-Applicants and senior CTRU staff that also satisfy the above requirements will be named as co-authors in any publication, which will be discussed amongst the Trial Management Group (TMG) members. In addition, all collaborators will be listed as contributors for the main study publication, giving details of their roles in planning, conducting and reporting the study.

Additional trial-related publication(s): Whilst the exact composition of the main publication remains to be determined, there may be opportunities to publish additional reports associated with the trial. The nature of authorship will be discussed for such reports individually with the TMG but

may take the form of a different lead (first) author with the Chief Investigator as senior author for example.

The SWITCH team should be acknowledged in all publications, as should NIHR HTA (as detailed in Section 6.4 below). Other key individuals will be included as authors or contributors as appropriate and at the discretion of the TMG. The Trial Steering Committee (TSC) will resolve any disputes relating to authorship.

The Chairs and Independent members of the TSC and Data Monitoring and Ethics Committee (DMEC) will be acknowledged, but will not qualify for full authorship, in order to maintain their independence. Bristol-Myers Squibb shall also be acknowledged for providing drug.

Relevant NIHR Clinical Research Networks' (e.g. CCRN) support should be acknowledged appropriately in trial publications.

## **6.2 Data release**

To maintain the scientific integrity of the study, data will not be released prior to the first publication of the results of the primary endpoint analysis, either for study publication or oral presentation purposes, without the permission of the DMEC and the TSC. The TSC will agree a publication plan and must be consulted prior to release or publication of any study data.

Individual collaborators must not publish data concerning their participants, which is directly relevant to the questions posed in the study until the main results of the study have been published. Local collaborators may not have access to study data until after publication of the main study results.

## **6.3 Processes for the drafting, review and submission of abstracts and manuscripts**

The Chief Investigator as first author of abstracts is responsible for circulating these to the other members of the TMG and the Sponsor for review at least 15 days prior to the deadline for submission.

The agreed first author of manuscripts is responsible for ensuring:

- timely circulation of all drafts to all co-authors during manuscript development and prior to submission
- timely (and appropriate) circulation of reviewers' comments to all co-authors
- incorporation of comments into subsequent drafts
- communication with the TSC (i.e. ensuring submission is in line with TSC publication plan, and ensuring TSC receive the final draft prior to submission)

The Chief Investigator as first author is responsible for submission of the publication and must keep the TMG and all authors informed of the abstract's or manuscript's status. The TSC will be kept informed of rejections and publications as these occur. On publication, the first author should send copies of the abstract or manuscript to the TSC, the TMG, the Sponsor and to all co-authors, and ensure communication with NIHR HTA programme as outlined below.

#### **6.4 Funder's Requirements**

All materials to be submitted for publication (written, audio/visual and electronic) will be prepared and submitted to the NIHR Co-ordinating Centre for HTA (NCCHTA) in accordance with the NIHR HTA programme's requirements at the time a publication is drafted. This applies to all publications regardless of whether or not the primary results have been published.

### **7. Statistical Analysis Plan References**

1. MOHER, D., S. HOPEWELL, K.F. SCHULZ, V. MONTORI, P.C. GOTZSCHE, P.J. DEVEREAUX, D. ELBOURNE, M. EGGER and D.G. ALTMAN. Consort 2010 explanation and elaboration: Updated guidelines for reporting parallel group randomised trials. *Bmj-British Medical Journal*, 2010, 340.
2. PIAGGIO, G., D.R. ELBOURNE, S.J. POCOCK, S.J.W. EVANS, D.G. ALTMAN and C. GRP. Reporting of noninferiority and equivalence randomized trials extension of the consort 2010 statement. *Jama-Journal of the American Medical Association*, 2012, 308(24), pp.2594-2604.
3. COHEN, S.B., P. EMERY, M.W. GREENWALD, M. DOUGADOS, R.A. FURIE, M.C. GENOVESE, E.C. KEYSTONE, J.E. LOVELESS, G.-R. BURMESTER, M.W. CRAVETS, E.W.

HESSEY, T. SHAW, M.C. TOTORITIS and R.T. GRP. Rituximab for rheumatoid arthritis refractory to anti-tumor necrosis factor therapy - results of a multicenter, randomized, double-blind, placebo-controlled, phase iii trial evaluating primary efficacy and safety at twenty-four weeks. *Arthritis and Rheumatism*, 2006, 54(9), pp.2793-2806.

4. NAVARRO-COY, N.C., S. BROWN, A. BOSWORTH, C.T. DAVIES, P. EMERY, C.C. EVERETT, C. FERNANDEZ, J.C. GRAY, S. HARTLEY, C. HULME, A.M. KEENAN, C. MCCABE, A. REDMOND, C. REYNOLDS, D. SCOTT, L.D. SHARPLES, S. PAVITT and M.H. BUCH. The 'switch' study protocol: A randomised-controlled trial of switching to an alternative tumour-necrosis factor (tnf)-inhibitor drug or abatacept or rituximab in patients with rheumatoid arthritis who have failed an initial tnf-inhibitor drug. *Bmc Musculoskeletal Disorders*, 2014, 15.

5. MARKENSON, J.A. Worldwide trends in the socioeconomic impact and long-term prognosis of rheumatoid arthritis. *Seminars in Arthritis and Rheumatism*, 1991, 21(2 SUPPL. 1), pp.4-12.

6. HARRIS, E.D. Mechanisms of disease - rheumatoid-arthritis - pathophysiology and implications for therapy. *New England Journal of Medicine*, 1990, 322(18), pp.1277-1289.

7. LEE, D.M. and M.E. WEINBLATT. Rheumatoid arthritis. *Lancet*, 2001, 358(9285), pp.903-911.

8. KEATING, N., P. OTFINOWSKI, C. WENGER, J. FAST and L. DERKSEN. Understanding the caring capacity of informal networks of frail seniors: A case for care networks. *Ageing and Society*, 2003, 23, pp.115-127.

9. BARRETT, E.M., D.G.I. SCOTT, N.J. WILES and D.P.M. SYMMONS. The impact of rheumatoid arthritis on employment status in the early years of disease: A uk community-based study. *Rheumatology*, 2000, 39(12), pp.1403-1409.

10. WOLFE, F. The epidemiology of drug-treatment failure in rheumatoid-arthritis. *Baillieres Clinical Rheumatology*, 1995, 9(4), pp.619-632.

11. BROOKS, P.M. Clinical management of rheumatoid-arthritis. *Lancet*, 1993, 341(8840), pp.286-290.

12. FELDMANN, M., F.M. BRENNAN and R.N. MAINI. Role of cytokines in rheumatoid arthritis. *Annual Review of Immunology*, 1996, 14, pp.397-440.

13. ELLIOTT, M.J., R.N. MAINI, M. FELDMANN, A. LONGFOX, P. CHARLES, P. KATSIKIS, F.M. BRENNAN, J. WALKER, H. BIJL, J. GHAYEB and J.N. WOODY. Treatment of rheumatoid-arthritis with chimeric monoclonal-antibodies to tumor-necrosis-factor-alpha. *Arthritis and Rheumatism*, 1993, 36(12), pp.1681-1690.

14. CHEN, Y.F., P. JOBANPUTRA, P. BARTON, S. JOWETT, S. BRYAN, W. CLARK, A. FRY-SMITH and A. BURLS. A systematic review of the effectiveness of adalimumab, etanercept and infliximab for the treatment of rheumatoid arthritis in adults and an economic evaluation of their cost-effectiveness. *Health technology assessment (Winchester, England)*, 2006, 10(42), pp.iii-iv, xi-xiii, 1-229.

15. LIPSKY, P.E., D. VAN DER HEIJDE, E.W. ST CLAIR, D.E. FURST, F.C. BREEDVELD, J.R. KALDEN, J.S. SMOLEN, M. WEISMAN, P. EMERY, M. FELDMANN, G.R. HARRIMAN, R.N. MAINI and T. ANTI-TUMOR NECROSIS FACTOR. Infiximab and methotrexate in the treatment of rheumatoid arthritis. *New England Journal of Medicine*, 2000, 343(22), pp.1594-1602.
16. BUCH, M.H., S.J. BINGHAM, V. BEJARANO, D. BRYER, J. WHITE, P. EMERY, R. REECE and M. QUINN. Therapy of patients with rheumatoid arthritis: Outcome of infiximab failures switched to etanercept. *Arthritis & Rheumatism-Arthritis Care & Research*, 2007, 57(3), pp.448-453.
17. BUCH, M.H. and P. EMERY. Nonresponse to tumor necrosis factor antagonists - is there any point in re-treatment? *Nature Clinical Practice Rheumatology*, 2006, 2(6), pp.288-289.
18. BUCH, M.H., Y. SETO, S.J. BINGHAM, V. BEJARANO, D. BRYER, J. WHITE and P. EMERY. C-reactive protein as a predictor of infiximab treatment outcome in patients with rheumatoid arthritis - defining subtypes of nonresponse and subsequent response to etanercept. *Arthritis and Rheumatism*, 2005, 52(1), pp.42-48.
19. GOMEZ-REINO, J.J., L. CARMONA and B. GRP. Switching tnf antagonists in patients with chronic arthritis: An observational study of 488 patients over a four-year period. *Arthritis Research & Therapy*, 2006, 8(1).
20. HANSEN, K.E., J.P. HILDEBRAND, M.C. GENOVESE, J.J. CUSH, S. PATEL, D.A. COOLEY, S.B. COHEN, R.E. GANGNON and M.H. SCHIFF. The efficacy of switching from etanercept to infiximab in patients with rheumatoid arthritis. *Journal of Rheumatology*, 2004, 31(6), pp.1098-1102.
21. HJARDEM, E., M. OSTERGAARD, J. PODENPHANT, U. TARP, L.S. ANDERSEN, J. BING, E. PEEN, H.M. LINDEGAARD, V.S. RINGSDAL, A. RODGAARD, J. SKOT, A. HANSEN, H.H. MOGENSEN, J. UNKERSKOV and M.L. HETLAND. Do rheumatoid arthritis patients in clinical practice benefit from switching from infiximab to a second tumor necrosis factor alpha inhibitor? *Annals of the Rheumatic Diseases*, 2007, 66(9), pp.1184-1189.
22. HYRICH, K.L., M. LUNT, K.D. WATSON, D.P.M. SYMMONS, A.J. SILMAN and B.R. BRITISH SOC RHEUMATOL. Outcomes after switching from one anti-tumor necrosis factor alpha agent to a second anti-tumor necrosis factor alpha agent in patients with rheumatoid arthritis - results from a large uk national cohort study. *Arthritis and Rheumatism*, 2007, 56(1), pp.13-20.
23. NIKAS, S.N., P.V. VOULGARI, Y. ALAMANOS, C.G. PAPADOPOULOS, A.I. VENETSANOPOULOU, A.N. GEORGIADIS and A.A. DROSOS. Efficacy and safety of switching from infiximab to adalimumab: A comparative controlled study. *Annals of the Rheumatic Diseases*, 2006, 65(2), pp.257-260.
24. VAN VOLLENHOVEN, R., A. HARJU, S. BRANNEMARK and L. KLARESKOG. Treatment with infiximab (remicade) when etanercept (enbrel) has failed or vice versa: Data from the sture registry showing that switching tumour necrosis factor alpha blockers can make sense. *Annals of the Rheumatic Diseases*, 2003, 62(12), pp.1195-1198.



25. VAN VOLLENHOVEN, R.F. Switching between biological agents. *Clinical and Experimental Rheumatology*, 2004, 22(5), pp.S115-S121.
26. WICK, M.C., S. ERNESTAM, S. LINDBLAD, J. BRATT, L. KLARESKOG and R.F. VAN VOLLENHOVEN. Adalimumab (humira (r)) restores clinical response in patients with secondary loss of efficacy from infliximab (remicade (r)) or etanercept (enbrel (r)): Results from the sture registry at karolinska university hospital. *Scandinavian Journal of Rheumatology*, 2005, 34(5), pp.353-358.
27. SMOLEN, J.S., J. KAY, M.K. DOYLE and G.-A.S. INVESTIGATORS. Golimumab in patients with active rheumatoid arthritis after treatment with tumour necrosis factor a inhibitors (go-after study): A multicentre, randomised, double-blind, placebo-controlled, phase iii trial. (vol 374, pg 210, 2009). *Lancet*, 2009, 374(9699), pp.1422-1422.
28. GENOVESE, M.C., J. BECKER, M. SCHIFF, M. LUGGEN, Y. SHERRER, J. KREMER, C. BIRBARA, J. BOX, K. NATARAJAN, I. NUAMAH, T. LI, R. ARANDA, D.T. HAGERTY and M. DOUGADOS. Abatacept for rheumatoid arthritis refractory to tumor necrosis factor alpha inhibition. *New England Journal of Medicine*, 2005, 353(11), pp.1114-1123.
29. DASS, S., E.M. VITAL and P. EMERY. Development of psoriasis after b cell depletion with rituximab. *Arthritis and Rheumatism*, 2007, 56(8), pp.2715-2718.
30. EMERY, P., R. FLEISCHMANN, A. FILIPOWICZ-SOSNOWSKA, J. SCHECHTMAN, L. SZCZEPANSKI, A. KAVANAUGH, A.J. RACEWICZ, R.F. VAN VOLLENHOVEN, N.F. LI, S. AGARWAL, E.W. HESSEY, T.M. SHAW and D.S. GRP. The efficacy and safety of rituximab in patients with active rheumatoid arthritis despite methotrexate treatment - results of a phase iib randomized, double-blind, placebo-controlled, dose-ranging trial. *Arthritis and Rheumatism*, 2006, 54(5), pp.1390-1400.
31. ISAACS J.D., O.E., TAK P.P., DEODHAR A., KEYSTONE E., EMERY P., YOCUM D., HESSEY E., READ S. Autoantibody-positive rheumatoid arthritis (ra) patients (pts) have enhanced clinical response to rituximab (rtx) when compared with seronegative patients. *Ann Rheum Dis.*, 2009, 68(Suppl3), p.442.
32. FINCKH, A., A. CIUREA, L. BRULHART, D. KYBURZ, B. MOELLER, S. DEHLER, S. REVAZ, J. DUDLER, C. GABAY and M. SWISS CLINICAL QUALITY. B cell depletion may be more effective than switching to an alternative anti-tumor necrosis factor agent in rheumatoid arthritis patients with inadequate response to anti-tumor necrosis factor agents. *Arthritis and Rheumatism*, 2007, 56(5), pp.1417-1423.
33. BUCH M., D.S., VITAL E., GOEB V., SZABO L., BRYER D. Is switching to rituximab more effective than switching to an alternative tumour necrosis factor blocking therapy (tnf-bt) in patients with rheumatoid arthritis (ra) who have failed previous tnf-bt? - single centre cohort experience. *Ann Rheum Dis.*, 2009, 68(Suppl3), p.574.
34. CHATZIDIONYSIOU S., C.C., VAN VOLLENHOVEN R. Rituximab versus anti-tnf in patients who have previously failed one or more anti-tnfs in an observational cohort: The sarastra study. *Ann Rheum Dis.*, 2009, 68(Suppl3), p.445.

35. NAM, J.L., K.L. WINTHROP, R.F. VAN VOLLENHOVEN, K. PAVELKA, G. VALESINI, E.M.A. HENSOR, G. WORTHY, R. LANDEWE, J.S. SMOLEN, P. EMERY and M.H. BUCH. Current evidence for the management of rheumatoid arthritis with biological disease-modifying antirheumatic drugs: A systematic literature review informing the eular recommendations for the management of ra. *Annals of the Rheumatic Diseases*, 2010, 69(6), pp.976-986.
36. SMOLEN, J.S., R. LANDEWE, F.C. BREEDVELD, M. DOUGADOS, P. EMERY, C. GAUJOUX-VIALA, S. GORTER, R. KNEVEL, J. NAM, M. SCHOELS, D. ALETAHA, M. BUCH, L. GOSSEC, T. HUIZINGA, J.W.J.W. BIJLSMA, G. BURMESTER, B. COMBE, M. CUTOLO, C. GABAY, J. GOMEZ-REINO, M. KOULOUMAS, T.K. KVIEN, E. MARTIN-MOLA, I. MCINNES, K. PAVELKA, P. VAN RIEL, M. SCHOLTE, D.L. SCOTT, T. SOKKA, G. VALESINI, R. VAN VOLLENHOVEN, K.L. WINTHROP, J. WONG, A. ZINK and D. VAN DER HEIJDE. Eular recommendations for the management of rheumatoid arthritis with synthetic and biological disease-modifying antirheumatic drugs. *Annals of the Rheumatic Diseases*, 2010, 69(6), pp.964-975.
37. O'KEEFE, D.J. Colloquy: Should familywise alpha be adjusted? Against familywise alpha adjustment. *Human Communication Research*, 2003, 29(3), pp.431-447.
38. PROSCHAN, M.A. and D.A. FOLLMANN. Multiple comparisons with control in a single experiment versus separate experiments - why do we feel differently. *American Statistician*, 1995, 49(2), pp.144-149.
39. VAN DER MAAS, A., E. LIE, R. CHRISTENSEN, E. CHOY, Y.A. DE MAN, P. VAN RIEL, T. WOODWORTH and A.A. DEN BROEDER. Construct and criterion validity of several proposed das28-based rheumatoid arthritis flare criteria: An omeract cohort validation study. *Annals of the Rheumatic Diseases*, 2013, 72(11), pp.1800-1805.
40. COHEN J. *Statistical power analysis for the behavioral sciences* 2nd ed. New Jersey: Lawrence Erlbaum Associates, 1988.
41. LEDINGHAM, J., C. DEIGHTON and SGAWG. Update on the british society for rheumatology guidelines for prescribing tn timer alpha blockers in adults with rheumatoid arthritis (update of previous guidelines of april 2001). *Rheumatology*, 2005, 44(2), pp.157-163.
42. THE CRITERIA COMMITTEE OF THE NEW YORK HEART ASSOCIATION. *Nomenclature and criteria for diagnosis of diseases of the heart and great vessels*. 9th ed. Boston, Mass.: Little, Brown & Co, 1994.
43. PREVOO, M.L.L., M.A. VAN'T HOF, H.H. KUPER, M.A. VAN LEEUWEN, L.B.A. VAN DE PUTTE and P.L.C.M. VAN RIEL. Modified disease activity scores that include twenty-eight-joint counts development and validation in a prospective longitudinal study of patients with rheumatoid arthritis. *Arthritis & Rheumatism*, 1995, 38(1), pp.44-48.
44. ANDERSON, J.K., L. ZIMMERMAN, L. CAPLAN and K. MICHAUD. Measures of rheumatoid arthritis disease activity patient (ptga) and provider (prga) global assessment of disease activity, disease activity score (das) and disease activity score with 28-joint counts (das28),

simplified disease activity index (sdai), clinical disease activity index (cdai), patient activity score (pas) and patient activity score-ii (pasii), routine assessment of patient index data (rapid), rheumatoid arthritis disease activity index (radai) and rheumatoid arthritis disease activity index-5 (radai-5), chronic arthritis systemic index (casi), patient-based disease activity score with esr (pdas1) and patient-based disease activity score without esr (pdas2), and mean overall index for rheumatoid arthritis (moi-ra). *Arthritis Care & Research*, 2011, 63, pp.S14-S36.

45. FELSON, D.T., J.J. ANDERSON, M. BOERS, C. BOMBARDIER, M. CHERNOFF, B. FRIED, D. FURST, C. GOLDSMITH, S. KIESZAK, R. LIGHTFOOT, H. PAULUS, P. TUGWELL, M. WEINBLATT, R. WIDMARK, H.J. WILLIAMS and F. WOLFE. The american-college-of-rheumatology preliminary core set of disease-activity measures for rheumatoid-arthritis clinical-trials. *Arthritis and Rheumatism*, 1993, 36(6), pp.729-740.
46. BYKERK, V.P. and E.M. MASSAROTTI. The new acr/ular remission criteria: Rationale for developing new criteria for remission. *Rheumatology*, 2012, 51(suppl 6), pp.vi16-vi20.
47. SMOLEN, J.S., F.C. BREEDVELD, M.H. SCHIFF, J.R. KALDEN, P. EMERY, G. EBERL, P.L. VAN RIEL and P. TUGWELL. A simplified disease activity index for rheumatoid arthritis for use in clinical practice. *Rheumatology*, 2003, 42(2), pp.244-257.
48. ALETAHA, D., V.P. NELL, T. STAMM, M. UFFMANN, S. PFLUGBEIL, K. MACHOLD and J.S. SMOLEN. Acute phase reactants add little to composite disease activity indices for rheumatoid arthritis: Validation of a clinical activity score. *Arthritis Research & Therapy*, 2005, 7(4), pp.R796-R806.
49. DE JONG, Z., D. VAN DER HEIJDE, S.P. MCKENNA and D. WHALLEY. The reliability and construct validity of the raqol: A rheumatoid arthritis-specific quality of life instrument. *Rheumatology*, 1997, 36(8), pp.878-883.
50. WHITE, I.R., P. ROYSTON and A.M. WOOD. Multiple imputation using chained equations: Issues and guidance for practice. *Statistics in Medicine*, 2011, 30(4), pp.377-399.
51. MORRIS, T.P., I.R. WHITE and P. ROYSTON. Tuning multiple imputation by predictive mean matching and local residual draws. *BMC medical research methodology*, 2014, 14(1), p.75.
52. RUBIN DB. *Multiple imputation for nonresponse in surveys*. New York: Wiley, 1987.
53. NEWCOMBE, R.G. Two-sided confidence intervals for the single proportion: Comparison of seven methods. *Statistics in Medicine*, 1998, 17(8), pp.857-872.
54. ---. Interval estimation for the difference between independent proportions: Comparison of eleven methods. *Statistics in Medicine*, 1998, 17(8), pp.873-890.

**Appendix A: CONSORT Checklist for Non-inferiority Randomised Trials (Non-inferiority requirements in *italics*)**

Section/Topic	Item No	Checklist item	Reported on page No
<b>Title and abstract</b>	1a	Identification as a randomised trial in the title. <i>Identification as a noninferiority randomized trial in the title</i>	_____
	1b	Structured summary of trial design, methods, results, and conclusions (for specific guidance see CONSORT for abstracts)	_____
<b>Introduction</b> Background and objectives	2a	Scientific background and explanation of rationale. <i>Rationale for using a noninferiority design</i>	_____
	2b	Specific objectives or hypotheses. <i>Hypotheses concerning noninferiority, specifying the noninferiority margin with the rationale for its choice</i>	_____
<b>Methods</b> Trial design	3a	Description of trial design (such as parallel, factorial) including allocation ratio	_____
	3b	Important changes to methods after trial commencement (such as eligibility criteria), with reasons	_____
Participants	4a	Eligibility criteria for participants. <i>Whether participants in the noninferiority trial are similar to those in any trial(s) that established efficacy of the reference treatment.</i>	_____
	4b	Settings and locations where the data were collected	_____
Interventions	5	The interventions for each group with sufficient details to allow replication, including how and when they were actually administered. <i>Whether the reference treatment in the noninferiority trial is identical (or very similar) to that in any trial(s) that established efficacy</i>	_____
Outcomes	6a	Completely defined pre-specified primary and secondary outcome measures, including how and when they were assessed. <i>Specify the noninferiority outcome(s) and whether hypotheses for main and secondary outcome(s) are noninferiority or superiority. Whether the outcomes in the noninferiority trial are identical (or very similar) to those in any trial(s) that established efficacy of the reference treatment.</i>	_____
	6b	Any changes to trial outcomes after the trial commenced, with reasons	_____

Sample size	7a	How sample size was determined. <i>Whether the sample size was calculated using a noninferiority criterion and, if so, what the noninferiority margin was.</i>	_____
	7b	When applicable, explanation of any interim analyses and stopping guidelines. <i>To which outcome(s) they apply and whether related to a noninferiority hypothesis</i>	_____
Randomisation:			
Sequence generation	8a	Method used to generate the random allocation sequence	_____
	8b	Type of randomisation; details of any restriction (such as blocking and block size)	_____
Allocation concealment mechanism	9	Mechanism used to implement the random allocation sequence (such as sequentially numbered containers), describing any steps taken to conceal the sequence until interventions were assigned	_____
Implementation	10	Who generated the random allocation sequence, who enrolled participants, and who assigned participants to interventions	_____
Blinding	11a	If done, who was blinded after assignment to interventions (for example, participants, care providers, those assessing outcomes) and how	_____
	11b	If relevant, description of the similarity of interventions	_____
Statistical methods	12a	Statistical methods used to compare groups for primary and secondary outcomes. <i>Whether a 1- or 2-sided confidence interval approach was used</i>	_____
	12b	Methods for additional analyses, such as subgroup analyses and adjusted analyses	_____
<b>Results</b>			
Participant flow (a diagram is strongly recommended)	13a	For each group, the numbers of participants who were randomly assigned, received intended treatment, and were analysed for the primary outcome	_____
	13b	For each group, losses and exclusions after randomisation, together with reasons	_____
Recruitment	14a	Dates defining the periods of recruitment and follow-up	_____
	14b	Why the trial ended or was stopped	_____

Baseline data	15	A table showing baseline demographic and clinical characteristics for each group	_____
Numbers analysed	16	For each group, number of participants (denominator) included in each analysis and whether the analysis was by original assigned groups	_____
Outcomes and estimation	17a	For each primary and secondary outcome, results for each group, and the estimated effect size and its precision (such as 95% confidence interval). <i>For the outcome(s) for which noninferiority was hypothesized, a figure showing confidence intervals and the noninferiority margin may be useful.</i>	_____
	17b	For binary outcomes, presentation of both absolute and relative effect sizes is recommended	_____
Ancillary analyses	18	Results of any other analyses performed, including subgroup analyses and adjusted analyses, distinguishing pre-specified from exploratory	_____
Harms	19	All important harms or unintended effects in each group (for specific guidance see CONSORT for harms)	_____
<b>Discussion</b>			
Limitations	20	Trial limitations, addressing sources of potential bias, imprecision, and, if relevant, multiplicity of analyses	_____
Generalisability	21	Generalisability (external validity, applicability) of the trial findings	_____
Interpretation	22	Interpretation consistent with results, balancing benefits and harms, and considering other relevant evidence. <i>Interpret results in relation to the noninferiority hypothesis. If a superiority conclusion is drawn for outcome(s) for which noninferiority was hypothesized, provide justification for switching</i>	_____
<b>Other information</b>			
Registration	23	Registration number and name of trial registry	_____
Protocol	24	Where the full trial protocol can be accessed, if available	_____
Funding	25	Sources of funding and other support (such as supply of drugs), role of funders	_____

## Appendix B – Protocol Deviators to be excluded from the Per-Protocol Analysis

The Per-Protocol Population is a subset of all participants in the trial comprising those who are more compliant with the trial protocol, perhaps with respect to achieving a minimum level of exposure to trial medication, not having any major protocol deviations – including eligibility violations – and availability of assessment data.

Where a site / patient's conduct in the SWITCH trial constitutes a Major Protocol Deviation, the patient will be excluded from the Primary Endpoint Analysis in the per-protocol population.

The tables below list all major eligibility violations and protocol deviations, which will determine patients to be excluded from the Per-Protocol analysis population for the primary endpoint. In addition, a patient receiving a treatment other than that chosen at randomisation will be analysed in the treatment group corresponding to the treatment received.

**Table B.1: Main categories of protocol deviation to be excluded from the Per-Protocol Population**

Patient was found to be ineligible after randomisation for the reasons listed in Table B.2 (putting the patient either outside the target population, or having an impact on the outcome assessments)

Between Baseline and Week 24, the patient was not compliant with methotrexate (ie not between 80%-120% of required dose)

Not received at least 80% of expected infusions or injections of IMP, i.e. received fewer than:

- Two infusions of rituximab (Week 0 and Week 2)
- Four infusions of infliximab (out of Week 0, 2, 6, 14 and 22)
- Five injections of golimumab (out of Week 0, 4, 8, 12, 16 and 20)
- Ten (out of 12 fortnightly) injections of certolizumab pegol or adalimumab;
- Twenty (out of 24 weekly) injections of etanercept or abatacept

Week 24 assessment was more than 30 weeks from baseline visit

Participant has been over or under dosed – i.e. received a larger or smaller dose at one or more treatments.

Protocol treatment was interrupted for more than 28 days

Participant received additional treatment regarded as contraindicated (as stated in Section 12.7.1 of the protocol) between randomisation and end of protocol treatment (Week 48)

Participant received additional steroids at least 6 weeks prior to an endpoint related disease activity assessment (as stated in section 12.7 of the protocol)

**Table B.2: Eligibility criteria which must be satisfied for membership of the Per-Protocol population**

<b>Inclusion Criteria</b>
2. Patients with a diagnosis of rheumatoid arthritis as per the ACR/EULAR 2010 classification criteria confirmed at least 24 weeks prior to the screening visit.
3. Patients who have failed conventional DMARD therapy as per NICE/BSR Guidelines(41) i.e. failure of at least 2 DMARDS including MTX.
4. Patients with persistent RA disease activity despite having been treated with a current initial TNFi agent for at least 12 weeks. Active RA defined as: <ul style="list-style-type: none"> <li>• Primary non-response: failing to improve DAS28 by &gt; 1.2 or failing to achieve <math>DAS28 \leq 3.2</math> within the first 12 to 24 weeks of starting the initial TNFi. This may include patients that have shown a reduction in DAS28 of &gt; 1.2 but still demonstrate unacceptably high disease activity in the physician's judgement with evidence of an overall DAS28 of <math>\geq 3.2</math></li> </ul> <p>OR</p> <ul style="list-style-type: none"> <li>• Secondary non-response: defined as inefficacy to first TNFi (having demonstrated prior satisfactory response) as per clinician judgement; with intolerance not the reason for cessation of first TNFi.</li> </ul>
5. MTX dose stable for 4 weeks prior to the screening visit and to be continued for the duration of the study.
6. Patients on NSAIDs and / or corticosteroids (oral prednisolone not exceeding 10mg daily) who have been on an unchanged regimen for at least 4 weeks prior to the screening visit and are expected to remain on a stable dose until the baseline assessments have been completed.
<b>Exclusion Criteria</b>
2. Patients with inflammatory joint disease of different origin, mixed connective tissue disease, Reiter's syndrome, psoriatic arthritis, systemic lupus erythematosus, or any arthritis with onset prior to 16 years of age.
3. Patients receiving doses of prednisolone > 10mg/day within the 4 weeks prior to the screening visit.
4. Patients receiving intra-articular or intra-muscular steroid injections within 4 weeks prior to the screening visit.
5. Patients who have previously received more than 1 TNFi drug OR any other biological therapy for the treatment of RA.
6. Patients unable or unwilling to stop treatment with a prohibited DMARD (i.e synthetic DMARD aside from MTX e.g. oral or injectable gold, chloroquine, hydroxychloroquine, cyclosporine, azathioprine, leflunomide, sulphasalazine) prior to the start of protocol treatment.
7. Treatment with any investigational drug in the last 12 weeks prior the start of protocol treatment.

### **Appendix C – Outline of scoring methodology for the RAQoL (Rheumatoid Arthritis Quality of Life Questionnaire)**

The 30 questions of the RAQoL are scored to provide an overall single summary score. Each question is scored using a simple binary score: each "Yes" response scores 1 point, each "No"



scores 0 points. The points from each question are then summed to produce the overall RAQoL, as a score out of 30 points.

If a patient fails to respond to between 1 and 6 questions, then the score can still be computed as a score out of 30 by rescaling the total scored by the number of completed responses.

$$RAQoL = \begin{cases} S & \text{if 0 are missing} \\ \frac{30}{30 - m} S & \text{if 1 - 6 are missing} \\ \text{missing} & \text{if 7 or more are missing} \end{cases}$$

Where S is the sum of all points from the completed questions, and m is the number of missing items.

For example, if 26 questions are completed, and these scored a total of 19 / 26, the RAQoL score is  $19 * (30/26) = 21.923 / 30$ .

It is recommended by the developers of the RAQoL that the score is treated only on an ordinal scale, and that summaries of the values are restricted to non-parametric statistics such as median, quartiles, minima and maxima.

### Appendix D – Outline of scoring methodology for the HAQ-DI (Health Assessment Questionnaire – Disability Index)

The questions of the HAQ-DI are scored within 8 domains of activity which are then combined to provide an overall single summary score on a scale of 0-3. The score for each of the eight domains are derived from asking the respondent to report the level of difficulty experienced when undertaking certain activities, and whether any aids, devices or other help is required to complete these activities. The eight domains of activity are listed in column A of the table below.

(A) Domain	(B) Question Count	(C) Matching Aid / Device(s)
Dressing and Grooming	2	Devices used for dressing;
Arising	2	Special or built-up chair
Eating	3	Built-up or special utensils
Walking	2	Cane; Walker; Crutches; Wheelchair
Hygiene	3	Raised toilet seat; bathtub seat; bathtub bar; Long handled appliances in bathroom
Reach	2	Long-handled appliances for reach
Gripping and Opening	3	Jar opener (for jars previously opened)
Chores and Housework	3	-

Each question in each domain is scored between 0 and 3, with 0 corresponding to the least level of difficulty experienced (None at all) and 3 to the greatest level of difficulty experienced (Unable to do). Then, of the 2 or 3 questions in each domain (see column B for how many questions apply) the highest value is taken as the overall score for each domain. For example, if in the hygiene domain a patient has three responses scored 1, 1 and 3, then the overall score for the hygiene is 3, being the maximum value reported.

Once the score for each domain is determined, the score is then increased to account for any need to use aids and devices or help from others. If any of the matching aids or devices (Column C) are selected for that domain, or help is reportedly needed to undertake activities in this domain, then a domain score of 0 or 1 is increased to 2 (if the domain score is already a 2 or a 3, then this has no impact).

Finally, the overall score is determined by taking the average of all non-missing domain scores. If fewer than 6 domains have complete scores, then the HAQ score is missing.

### **Appendix E – Outline of scoring methodology for the HADS (Hospital Anxiety and Depression Scale)**

The 14 questions of the HADS are grouped within 2 domains, which are scored and summarised separately. Question responses are scored with a value of 0-3, with 0 representing least level of anxiety or depression, and 3 representing the greatest level of anxiety or depression. After each question is scored (some questions require “reverse scoring”, to account for responses being presented in different orders) the responses are summed within each domain to create the anxiety scale score and the depression scale score.

<b>Anxiety Scale</b>		<b>Depression Scale</b>	
<b>Question</b>	<b>Lowest Level</b>	<b>Question</b>	<b>Lowest Level</b>
Tense or “Wound Up”	0 = Not at all	Enjoy things	0 = Definitely as much
Frightened feeling	0 = Not at all	See funny side of things	0 = As much as always
Worrying thoughts	0 = Very little	Feel cheerful	0 = Most of the time
At ease and Relaxed	0 = Definitely	Slowed Down	0 = Not at all
Butterflies in stomach	0 = Not at all	Lost interest in appearance	0 = Just as much care as ever
Feel restless	0 = Not at all	Look forward to things	0 = As much as ever
Sudden panic	0 = Not at all	Enjoy good book etc	0 = Often

**Approval of Analysis Plan**

Clinical Trials Research Unit (CTRU)

The following analysis plan for the SWITCH study has been approved by the following personnel. Any signed amendments to the plan will be filed with this document.

Trial Statistician: Colin Everett

Signature: \_\_\_\_\_

Date: \_\_\_\_\_

Supervising Statistician: Sarah Brown

Signature: \_\_\_\_\_

Date: \_\_\_\_\_

Study Scientific Lead: Linda Sharples

Signature: \_\_\_\_\_

Date: \_\_\_\_\_

Senior Trial Co-ordinator: Claire Davies

Signature: \_\_\_\_\_

Date: \_\_\_\_\_

Data Manager: Catherine Reynolds

Signature: \_\_\_\_\_

Date: \_\_\_\_\_

CTRU Project Delivery Lead: Catherine Fernandez

Signature: \_\_\_\_\_

Date: \_\_\_\_\_

Chief Investigator: Maya Buch

Signature: \_\_\_\_\_

Date: \_\_\_\_\_

Additional information:

## Analysis Plan Amendment and Deviation Log

Current Version Number	New Version Number *	Section	Description and Reason for Amendment or Deviation	Trial Statistician Name & Date	Supervising Statistician Name & Date
1.0		5.2.2 5.1.3	<p>Planned primary endpoint analysis was to model change from baseline at Week 24 in DAS28, and consider the mean changes in experimental arms relative to a non-inferiority margin of -0.6 in light of the treatment contrast of Rituximab - experimental.</p> <p>Decision to reverse the comparison for presentation purposes, resulting in a “flipping” of the values about the line x=0 of the results figure, and consideration of the NI margin of 0.6. Achieved by quantifying “improvement” or “reduction” in DAS28, rather than “change”. Original derived change values reversed by multiplying by -1, and repeating the analysis.</p>	Colin Everett 01 SEP 2016	Sarah Brown 01 Sep 2016
1.0		S2.4.5	<p>Planned key secondary endpoint analysis of ACR Response considered change in ESR or CRP equally: either a 20% reduction in ESR or a 20% reduction in CRP should count towards ACR20 Response at any timepoint for all patients. Following discussion as to whether the results of both blood tests should count at all follow-up times, or if e.g. the first instance of ESR 20% reduction should result in ignoring all subsequent changes in CRP (or vice versa) for that patient in determining ACR Response, a clinician informed both that the latter approach was correct.</p> <p>Following this log is a detailed description of how the endpoint was ultimately derived in SWITCH.</p>	Colin Everett 01 SEP 2016	Sarah Brown 01 Sep 2016

\* If the analysis plan is amended, note the new version number. If a deviation is made from the analysis plan within the analysis, leave blank.

1.0		S5.1.13	Planned analysis for longitudinal modelling was that random coefficient models would form the basis of quantifying the overall linear treatment effects over time, while covariance pattern models would be used to display graphically fitted values over time.	Colin Everett	Sarah Brown
			Due to model assumptions for the random coefficients model not holding, covariance pattern models were fitted quantifying the varying the treatment effect over time.	01 SEP 2016	01 Sep 2016

## Implementation of the ACR Response criteria in SWITCH

The American College of Rheumatology Response criteria were interpreted to result in “consistency” of use of laboratory inflammatory markers to account for the longitudinal patient follow-up. The Table below illustrates the approach taken in SWITCH for five hypothetical patients when deciding whether ESR alone, CRP alone or both ESR and CRP should be used to derive ACR Response.

Patient	Baseline	Week 12	Week 24	Week 36	Week 48
A	ESR Known	<b>Response</b>	<b>Response</b>	<b>No Response</b>	<b>No Response</b>
	CRP Known	<b>Response</b>	Ignored (Non Resp)	Ignored (Resp)	Ignored (Resp)
B	ESR Known	<b>Did Not Attend</b>	<b>No Response</b>	<b>Response</b>	<b>No Response</b>
	CRP Known	<b>Did Not Attend</b>	<b>No Response</b>	Ignored (Non Resp)	Ignored (Resp)
C	ESR Known	No Response	Ignored (Resp)	Ignored (Resp)	Ignored (Resp)
	CRP Known	<b>Response</b>	<i>Missing</i>	<b>No Response</b>	<b>Response</b>
D	ESR Known	<b>No Response</b>	<b>No Response</b>	<b>No Response</b>	<b>Response</b>
	CRP Known	<i>Missing</i>	Ignored (Non Resp)	Ignored (Non Resp)	Ignored (Resp)
E	ESR Known	<b>Response</b>	<b>Missing</b>	<b>No Response</b>	<b>Response</b>
	<i>CRP Missing</i>	Unknown	Unknown	Unknown	Unknown

Table – Derivation of inflammatory marker improvement over length of follow-up. A bolded cell indicates that, at this follow-up visit, the value was used to determine if the inflammatory marker test result counted toward ACR Response. Cells in **bold** indicate which of the two test values are used in deriving ACR Response at each visit.

Patient A: Both ESR / CRP known at baseline. At Week 12, both ESR/CRP show (eg) 20% improvement. At week 24, ESR shows improvement, so CRP is disregarded at this visit, and all subsequent visits, even though doing so ignores required CRP response later on.



Patient B: As for patient A, except at Week 12 did not attend. At Week 24, ESR and CRP agree that no-response was seen. At Week 36, ESR Response is seen, so CRP is disregarded at that time, and for the final visit.

Patient C: At the first visit CRP response is seen, which overrules the ESR non-response at that visit. CRP is used from Week 24 onwards. At Week 24, no CRP value is available, so CRP response is missing. We do not use the known ESR response value at this visit: we continue using only CRP, even if it is not known at a visit.

Patient D had both values known at baseline, but the CRP value was missing at the first observed follow-up visit. Since the ESR value was known, the ESR value is used for all future visits, and CRP is ignored.

Patient E had a missing CRP at baseline. It is not possible to derive a relative change from baseline when the baseline value is not known, so the ESR value is used exclusively at all visits. Had the ESR value also been unknown, then neither ESR nor CRP response / non-response can be derived at any subsequent visit.



## Appendix 8 Key protocol amendments

Version of patient information sheet containing amendment	Additional document created	Description of the protocol amendment
4.0	N/A	Amendment from intravenous formulation of abatacept to subcutaneous formulation following agreement from manufacturers of abatacept to provide trial supplies. This also required changes to other documentation to: <ol style="list-style-type: none"> <li>include a further vendor responsible for packaging and labelling of the abatacept trial supplies</li> <li>amend wording on the labels for subcutaneous abatacept</li> </ol>
N/A	Abatacept participant letter	Approval was obtained for a letter to provide to participants that explained a discrepancy between the expiry date given on the internal and external packaging of abatacept
4.0	N/A	Inclusion of the option for subcutaneous IMPs to be sourced and delivered to participants' homes by third-party home health-care providers as per local hospital practice
5.0	N/A	Clarification included that when local practice indicates the use of a home health-care provider for the delivery of subcutaneous IMPs, the trial procedures will map onto the established standard care practices in place at each individual site in terms of services and record-keeping and retention requirements
6.0	N/A	Addition of golimumab to the alternative-mechanism TNFi arm following feedback from sites that the use of golimumab was becoming more commonplace and, therefore, the ability to use this may expand the field of potential patients/increase pragmatism of study would reflect standard practice more closely
6.0	N/A	Modification of the primary end point from a dichotomous end point (whether or not the patient achieved a reduction of > 1.2 units in the DAS28 with no toxicity) to a continuous end point (change in the DAS28)
N/A	Patient advert, version 1.0	Designed to advertise the trial directly to patients, with the intention that sites display the patient advert in patient waiting rooms, etc. In addition, information contained within the advert was intended to be used via various means, for example patient websites, e-bulletins and social media for the purpose of advertising the trial to the wider RA community
N/A	Patient information summary sheet, version 1.0	A participant information summary sheet was created to summarise and complement the main PIS/ICD before the patient reads the main PIS/ICD following feedback from patient and public involvement representatives that the current PIS/ICD was lengthy and a supplementary summary sheet would be beneficial
7.0	N/A	Corrections of errors noted in the research ethics committee form and the patient information sheet relating to the amount of radiation that patients would be exposed to as part of the imaging aspects of the study
N/A	N/A	Research and development form amended to enable the use of participant identification centres, as a number of investigators suggested that they had clinics at other sites where eligible patients may be seen and who they would be able to refer to their main site in order to screen for participation

PIS/ICD, participant information sheet and informed consent document.



## Appendix 9 Screening and withdrawals

**TABLE 40** Summary of patients considered for inclusion in SWITCH, with status up to randomisation, including reasons for non-registration

Centre name and number	Patient was ineligible (n = 417)	Patient was eligible but did not consent (n = 90)	Clinician preferred particular treatment (n = 12)	Clinician wishes to continue current treatment, despite non-response (n = 5)	Did not attend (n = 2)	No reason given for non-registration (n = 3)	Considered, registered, but not randomised (n = 27)	Randomised (n = 122)	Total (n = 678)
Chapel Allerton Hospital, Leeds; N00482	7	5	–	–	–	–	8	32	52
Cannock Chase Hospital; N00473	29	5	–	–	–	–	2	8	44
Manchester Royal Infirmary; N00080	28	6	–	–	–	–	3	6	43
Airedale General Hospital; N00074	2	4	–	–	1	–	2	6	15
Derriford Hospital, Plymouth; N00118	5	–	–	–	–	–	2	6	13
King George Hospital, Ilford; N00165	6	–	–	–	–	–	1	6	13
Queen Elizabeth Hospital, Gateshead; N00071	2	4	–	–	–	–	–	6	12
Royal National Hospital for Rheumatic Diseases, Bath; N02220	15	7	1	–	–	–	1	5	29
Birmingham City Hospital; N00346	24	6	–	–	–	–	–	5	35
Hull Royal Infirmary; N00078	13	–	–	–	–	–	1	4	18
Royal Hallamshire Hospital, Sheffield; N00093	20	9	–	–	–	–	–	4	33
Leicester Royal Infirmary; N00031	17	5	–	–	–	2	–	4	28
Queen's Hospital, Burton upon Trent; N00178	16	6	1	–	–	–	–	4	27
University Hospital, North Durham; N00170	5	1	1	–	–	–	1	3	11
Poole Hospital; N00108	53	2	–	–	–	1	–	3	59
Northampton General Hospital; N00038	2	–	–	–	–	–	–	3	5
New Cross Hospital, Wolverhampton; N00034	–	–	–	–	–	–	–	3	3

Centre name and number	Patient was ineligible (n = 417)	Patient was eligible but did not consent (n = 90)	Clinician preferred particular treatment (n = 12)	Clinician wishes to continue current treatment, despite non-response (n = 5)	Did not attend (n = 2)	No reason given for non-registration (n = 3)	Considered, registered, but not randomised (n = 27)	Randomised (n = 122)	Total (n = 678)
Salford Royal Infirmary; N00400	–	–	–	–	–	–	–	3	3
Broadgreen Hospital, Liverpool; N00589	3	–	–	–	–	–	–	2	5
Royal Victoria Infirmary, Newcastle; N00072	31	8	4	–	–	–	2	1	46
Nuffield Orthopaedic Centre, Oxford; N00282	71	1	3	5	–	–	1	1	82
Royal Derby Hospital; N00168	34	5	1	–	–	–	–	1	41
Queen Alexandra Hospital, Portsmouth; N00110	11	3	–	–	–	–	–	1	15
Guy's Hospital, London; N00241	4	2	–	–	–	–	–	1	7
Darlington Memorial Hospital; N00068	–	3	–	–	–	–	–	1	4
Harrogate District Hospital; N00076	–	–	–	–	–	–	–	1	1
Bristol Royal Infirmary; N00117	–	–	–	–	–	–	–	1	1
Musgrove Park Hospital, Taunton; N00306	–	–	–	–	–	–	–	1	1
Royal London Hospital (Ex Mile End); N01705	2	2	–	–	–	–	1	–	5
St Peter's Hospital, Ashford; N00052	2	–	1	–	–	–	1	–	4
Raigmore Hospital, Inverness; N00355	–	2	–	–	–	–	1	–	3
Southend Hospital; N00049	14	2	–	–	1	–	–	–	17
Wythenshawe Hospital, Manchester; N00172	1	2	–	–	–	–	–	–	3

**TABLE 41** Summary of reasons for ineligibility leading to patients not being approached for consent for the SWITCH trial

Reason for ineligibility	Total (n = 417), n (%)
Has not experienced RS disease activity on an initial TNFi agent	95 (22.8)
Has not been on a stable dose of MTX for 28 days prior to screening	92 (22.1)
Has received more than one TNFi drug OR any other biological therapy	72 (17.3)
Has not failed conventional DMARD therapy (including MTX)	32 (7.7)
Has another comorbidity	23 (5.5)
Has not had a diagnosis of RA	14 (3.4)
Has inflammatory joint disease of different origin	9 (2.2)
Is pregnant, lactating or a woman of child-bearing potential	8 (1.9)
Has scheduled or anticipated surgery	7 (1.7)
Has received intra-articular or intramuscular steroid injections	7 (1.7)
No reason provided	7 (1.7)
Is under 18 years of age	5 (1.2)
Is unable to provide written informed consent prior to trial	4 (1.0)
Is unable or unwilling to stop treatment with a prohibited DMARD	4 (1.0)
Has untreated active current or latent TB	4 (1.0)
Is known to have active current or history of recurrent infections.	3 (0.7)
Has received doses of prednisolone > 10 mg/day	2 (0.5)
Has had treatment with any investigational drug in the last 90 days before study drug admin.	2 (0.5)
Has significantly impaired bone marrow function.	2 (0.5)
Is currently on NSAIDs and/or corticosteroids but not an unchanged regimen	1 (0.2)
Unable/unwilling to stop etanercept $\geq$ 4 weeks or infliximab/adalimumab/certolizumab $\geq$ 8 weeks prior to study drug administration	1 (0.2)
Has had a major episode of infection	1 (0.2)
Is at significant risk of infection	1 (0.2)
Has severe hypoproteinaemia	1 (0.2)
Other	20 (4.8)

**TABLE 42** Summary of reasons for non-consent leading to patients not being approached for consent for the SWITCH trial

Reason for non-consent	Total (n = 90), n (%)
Does not want to be involved in the research	32 (35.6)
Refused without any reason	19 (21.1)
Patient preference for or against one or more treatments	10 (11.1)
Took/taken part in competing study	9 (10.0)
Language difficulties	4 (4.4)
Feels poorly or unwell	3 (3.3)
Patient refused to be randomised	3 (3.3)
Considered study schedule compliance to be burdensome	2 (2.2)
Patient did not respond	2 (2.2)
Other reason	6 (6.7)



**TABLE 43** Summary of reasons given for ineligibility among the 19 patients who were registered but found to be ineligible following pre-randomisation tests

Reason for ineligibility	Total, <i>n</i>
Persistent RA disease activity	6
Stable dose of MTX	4
Stable regimen of NSAIDs	2
Had or anticipated major surgery	2
Untreated active current TB	2
Steroid injections within 28 days before screening	2
Prior regimens	2
Participant failed conventional DMARD therapy	1
Major episode of infection	1
Significant risk of infection	1
Recurrent bacterial, viral, fungal or mycobacterial infections	1
Significantly impaired bone marrow function	1
Other comorbidities	1

**TABLE 44** Summary of characteristics of patients who were considered for participation in the SWITCH trial

Patient characteristic	Considered, but not registered ( <i>N</i> = 529)	Consented and registered, but not randomised ( <i>N</i> = 27)	Randomised ( <i>N</i> = 122)	Total ( <i>N</i> = 678)
Age (years)				
Mean (SD)	56.9 (13.67)	56.9 (14.15)	56.6 (12.21)	56.9 (13.41)
Range	2.0–86.0	30.4–81.1	24.4–81.6	2.0–86.0
Missing	36	0	0	36
Sex, <i>n</i> (%)				
Male	103 (19.5)	5 (18.5)	21 (17.2)	129 (19.0)
Female	418 (79.0)	22 (81.5)	101 (82.8)	541 (79.8)
Not known	8 (1.5)	–	–	8 (1.2)
RF status, <i>n</i> (%)				
RF seropositive	250 (47.3)	17 (63.0)	82 (67.2)	349 (51.5)
RF seronegative	69 (13.0)	5 (18.5)	38 (31.1)	112 (16.5)
Not known	210 (39.7)	5 (18.5)	2 (1.6)	217 (32.0)
ACPA status, <i>n</i> (%)				
Positive	154 (29.1)	16 (59.3)	76 (62.3)	246 (36.3)
Negative	58 (11.0)	4 (14.8)	35 (28.7)	97 (14.3)
Not known	317 (59.9)	7 (25.9)	11 (9.0)	335 (49.4)

**TABLE 45** Listing of patient and clinician withdrawals

Centre	Patient number	Randomised treatment	Date of randomisation	Date of withdrawal request	Withdrawn from further trial treatment	Follow-up as per trial schedule	Collection of further data from notes	Withdrawal reason
00080	00023	Monoclonal antibody	14 August 2013	11 November 2013	Yes	No	No	Lack of efficacy
00118	00060	Etanercept	2 January 2014	12 May 2015	Yes	No	Yes	Flares of arthritis and poor response from trial drugs. Patient agrees to switch to a new biologic
00038	00126	Etanercept	10 September 2014	21 May 2015	N/A	No	Yes	Because of ill health she has missed a lot of time at work and cannot take any more time off to attend research appointments
00118	00068	Abatacept	12 February 2014	12 May 2015	Yes	No	Yes	Poor response from the randomised medication and worsening arthritis and frequent flares
00118	00109	Abatacept	18 July 2014	12 May 2015	Yes	No	Yes	Poor response from trial drugs. Flare of arthritis and unwilling to continue in trial. Participant switching to rituximab
00118	00109	Abatacept	18 July 2014	14 April 2015	Yes	No	No	Participant was requesting to switch biologic because of reduced efficacy and because of a house move. No longer wanted appointments
00178	00134	Abatacept	9 October 2014	12 December 2014	No	–	–	Owing to chest infection principal investigator wishes to withdraw patient from the study
00117	00145	Abatacept	17 November 2014	14 August 2015	Yes	Yes	–	Would like to get pregnant
00482	00007	Rituximab	11 December 2012	23 August 2013	Yes	No	No	Patient does not want further treatment or any follow-up appointments, declined at every level. The patient declined any further treatment from the rheumatology department in general
00080	00017	Rituximab	13 June 2013	17 June 2014	Yes	No	No	No reason given
00093	00135	Rituximab	7 October 2014	19 March 2015	Yes	No	Yes	Participant's choice

## Appendix 10 Per protocol population summary tables

**TABLE 46** Summary of reasons for exclusion from the PP population

Reason for exclusion	Treatment arm, <i>n</i> (%)			Total ( <i>N</i> = 122), <i>n</i> (%)
	Alternative TNFi ( <i>N</i> = 41)	Abatacept ( <i>N</i> = 41)	Rituximab ( <i>N</i> = 40)	
Excluded from the PP population	28 (68.3)	27 (65.9)	26 (65.0)	81 (66.4)
Unacceptable eligibility violation	1 (2.4)	–	1 (2.5)	2 (1.6)
Week 24 assessment did not occur within 30 weeks of baseline				
Failed because week 24 visit did not occur	4 (9.8)	3 (7.3)	–	7 (5.7)
Failed because week 24 was > 30 weeks from baseline	5 (12.2)	2 (4.9)	7 (17.5)	14 (11.5)
Received additional contraindicated treatment	10 (24.4)	9 (22.0)	4 (10.0)	23 (18.9)
Protocol treatment interrupted for > 28 days	–	3 (7.3)	–	3 (2.5)
Participant was under- or overdosed	–	–	–	–
Received steroid treatment within 6 weeks of an end-point assessment	10 (24.4)	13 (31.7)	12 (30.0)	35 (28.7)
Not compliant with MTX up to week 24	5 (12.2)	3 (7.3)	4 (10.0)	12 (9.8)
Not compliant with treatment up to week 24	10 (24.4)	12 (29.3)	5 (12.5)	27 (22.1)

Patient N00080/00069 was ineligible because of comorbidity, but this criterion was not grounds for exclusion from the PP population. A patient's conduct can violate the protocol in multiple ways, but can be excluded only once. Hence, the number of reasons for exclusion may exceed the number of patients excluded.

TABLE 47 Minimisation factors: PP population

Minimisation factor	Treatment arm, <i>n</i> (%)			Total ( <i>N</i> = 41), <i>n</i> (%)
	Alternative TNFi ( <i>N</i> = 13)	Abatacept ( <i>N</i> = 14)	Rituximab ( <i>N</i> = 14)	
Centre name and number				
Chapel Allerton Hospital, Leeds; N00482	3 (23.1)	2 (14.3)	5 (35.7)	10 (24.4)
King George Hospital, Ilford; N00165	2 (15.4)	2 (14.3)	1 (7.1)	5 (12.2)
Royal Hallamshire Hospital, Sheffield; N00093	2 (15.4)	1 (7.1)	–	3 (7.3)
Derriford Hospital, Plymouth; N00118	1 (7.7)	1 (7.1)	1 (7.1)	3 (7.3)
Airedale General Hospital; N00074	1 (7.7)	1 (7.1)	–	2 (4.9)
Hull Royal Infirmary; N00078	–	1 (7.1)	1 (7.1)	2 (4.9)
Poole Hospital; N00108	1 (7.7)	–	1 (7.1)	2 (4.9)
University Hospital, North Durham; N00170	–	–	2 (14.3)	2 (4.9)
Broadgreen Hospital, Liverpool; N00589	1 (7.7)	1 (7.1)	–	2 (4.9)
New Cross Hospital, Wolverhampton; N00034	–	1 (7.1)	–	1 (2.4)
Darlington Memorial Hospital; N00068	–	1 (7.1)	–	1 (2.4)
Queen Elizabeth Hospital, Gateshead; N00071	1 (7.7)	–	–	1 (2.4)
Manchester Royal Infirmary; N00080	–	–	1 (7.1)	1 (2.4)
Queen Alexandra Hospital, Portsmouth; N00110	–	–	1 (7.1)	1 (2.4)
Bristol Royal Infirmary; N00117	–	1 (7.1)	–	1 (2.4)
Queen's Hospital, Burton upon Trent; N00178	1 (7.7)	–	–	1 (2.4)
Musgrove Park Hospital, Taunton; N00306	–	1 (7.1)	–	1 (2.4)
Salford Royal Infirmary; N00400	–	–	1 (7.1)	1 (2.4)
Cannock Chase Hospital; N00473	–	1 (7.1)	–	1 (2.4)
Disease duration				
< 5 years	3 (23.1)	4 (28.6)	4 (28.6)	11 (26.8)
≥ 5 years	10 (76.9)	10 (71.4)	10 (71.4)	30 (73.2)
RA/ACPA seropositivity				
RF seropositive and/or anti-CCP seropositive	12 (92.3)	9 (64.3)	12 (85.7)	33 (80.5)
Both RF seronegative and anti-CCP seronegative	1 (7.7)	5 (35.7)	2 (14.3)	8 (19.5)
Non-response category				
Primary	4 (30.8)	6 (42.9)	8 (57.1)	18 (43.9)
Secondary	9 (69.2)	8 (57.1)	6 (42.9)	23 (56.1)

CCP, cyclic citrullinated peptide.

TABLE 48 Demographic information: PP population

Patient characteristic	Treatment arm			Total (N = 41)
	Alternative TNFi (N = 13)	Abatacept (N = 14)	Rituximab (N = 14)	
Participant sex, n (%)				
Male	4 (30.8)	1 (7.1)	6 (42.9)	11 (26.8)
Female	9 (69.2)	13 (92.9)	8 (57.1)	30 (73.2)
Derived patient age (years)				
Mean (SD)	55.3 (9.40)	53.4 (15.00)	58.1 (11.82)	55.6 (12.21)
Range	40.8–67.0	28.8–76.2	41.0–81.1	28.8–81.1
Missing	0	0	0	0
Body mass index (kg/m <sup>2</sup> )				
Mean (SD)	29.8 (5.45)	29.9 (6.23)	30.9 (5.34)	30.2 (5.54)
Median (IQR)	28.3 (27.4–34.1)	27.9 (24.6–36.8)	29.0 (26.4–33.5)	29.0 (25.3–34.9)
Missing	0	2	1	3
Smoking status, n (%)				
Non-smoking (never smoked)	3 (23.1)	6 (42.9)	7 (50.0)	16 (39.0)
Past smoker	5 (38.5)	4 (28.6)	6 (42.9)	15 (36.6)
Current smoker	5 (38.5)	4 (28.6)	1 (7.1)	10 (24.4)
Prior comorbidities, n (%)				
Asthma	3 (23.1)	–	1 (7.1)	4 (9.8)
Bowel disease	–	–	1 (7.1)	1 (2.4)
Cancer	–	–	1 (7.1)	1 (2.4)
Depression	3 (23.1)	2 (14.3)	–	5 (12.2)
Diabetes	–	1 (7.1)	3 (21.4)	4 (9.8)
Hypercholesterolaemia	–	4 (28.6)	4 (28.6)	8 (19.5)
Hypertension	4 (30.8)	7 (50.0)	5 (35.7)	16 (39.0)
Ischaemic heart disease	1 (7.7)	–	2 (14.3)	3 (7.3)
Myocardial infarction	–	–	2 (14.3)	2 (4.9)
Osteoarthritis	4 (30.8)	3 (21.4)	5 (35.7)	12 (29.3)
Peptic ulcer disease	–	1 (7.1)	1 (7.1)	2 (4.9)
Peripheral vascular disease	–	–	1 (7.1)	1 (2.4)
Stroke	–	–	1 (7.1)	1 (2.4)
Thyroid dysfunction	3 (23.1)	3 (21.4)	–	6 (14.6)

IQR, interquartile range.

TABLE 49 Disease and treatment history: PP population

Disease activity/treatment history	Treatment arm			Total (N = 41)
	Alternative TNFi (N = 13)	Abatacept (N = 14)	Rituximab (N = 14)	
Disease duration (years)				
Median (IQR)	9.3 (5.7–17.5)	6.5 (4.4–10.6)	8.1 (4.0–15.3)	8.0 (4.4–14.3)
Range	2.2–35.2	1.1–20.4	1.3–33.7	1.1–35.2
Missing	0	0	0	0
TJC (/28)				
Mean (SD)	13.2 (5.55)	17.5 (7.98)	21.1 (6.96)	17.4 (7.51)
Missing	0	0	0	0
SJC (/28)				
Mean (SD)	8.3 (5.38)	9.4 (6.16)	12.3 (8.13)	10.0 (6.73)
Missing	0	0	0	0
Does the participant experience early-morning stiffness?, n (%)				
Yes	12 (92.3)	14 (100.0)	14 (100.0)	40 (97.6)
No	1 (7.7)	–	–	1 (2.4)
ESR (mm/hour)				
Median (IQR)	14.0 (8.0–22.0)	23.5 (12.0–34.0)	26.5 (15.0–42.0)	21.0 (11.0–32.0)
Missing	0	0	0	0
CRP level (mg/l)				
Median (IQR)	5.0 (3.8–10.1)	8.5 (5.0–19.0)	6.5 (6.0–21.0)	6.0 (4.5–16.5)
Range	1.0–66.0	1.0–58.2	2.1–78.0	1.0–78.0
Type of TNFi failed (derived), n (%)				
Monoclonal antibody	10 (76.9)	7 (50.0)	8 (57.1)	25 (61.0)
Etanercept	3 (23.1)	7 (50.0)	6 (42.9)	16 (39.0)
Previous TNFi agent, n (%)				
Adalimumab	2 (15.4)	3 (21.4)	4 (28.6)	9 (22.0)
CZP	6 (46.2)	3 (21.4)	–	9 (22.0)
Etanercept	3 (23.1)	7 (50.0)	6 (42.9)	16 (39.0)
Golimumab	1 (7.7)	–	1 (7.1)	2 (4.9)
Infliximab	1 (7.7)	1 (7.1)	3 (21.4)	5 (12.2)

IQR, interquartile range.

**TABLE 50** Baseline disease activity: PP population

Disease activity	Treatment arm			Total (n = 41)
	Alternative TNFi (n = 13)	Abatacept (n = 14)	Rituximab (n = 14)	
DAS28 (baseline)				
Mean (SD)	5.3 (0.73)	6.2 (0.85)	6.6 (1.22)	6.0 (1.09)
Missing	0	0	1	1
CDAI				
Mean (SD)	32.8 (12.80)	41.0 (12.97)	47.0 (13.43)	40.3 (14.02)
Missing	0	1	1	2
SDAI				
Mean (SD)	32.8 (13.22)	42.6 (13.17)	48.8 (14.27)	41.6 (14.76)
Missing	1	1	1	3
Physician Global Assessment of Disease Activity (mm)				
Median (IQR)	60.0 (45.0–70.0)	66.0 (57.3–81.0)	65.0 (62.0–84.3)	63.5 (53.5–79.0)
Missing	0	1	0	1

IQR, interquartile range.

**TABLE 51** Baseline patient-reported outcomes: PP population

Patient-reported outcome	Treatment arm			Total (n = 41)
	Alternative TNFi (n = 13)	Abatacept (n = 14)	Rituximab (n = 14)	
Patient Global Assessment of Arthritis VAS (mm)				
Median (IQR)	68.0 (49.0–76.0)	69.5 (64.0–81.0)	74.0 (48.0–88.0)	72.0 (56.5–81.5)
Missing	0	0	1	1
Patient Assessment of General Health VAS (mm)				
Median (IQR)	58.0 (47.0–74.0)	61.5 (51.0–67.0)	67.0 (29.0–72.0)	61.0 (47.5–71.0)
Missing	0	0	1	1
Patient Global Assessment of Pain VAS (mm)				
Median (IQR)	66.0 (51.0–78.0)	73.0 (64.0–79.0)	78.0 (61.0–95.0)	73.0 (58.5–86.0)
Missing	0	0	1	1
HAQ-DI score				
Median (IQR)	1.9 (1.8–2.1)	1.8 (1.6–2.0)	2.0 (1.4–2.5)	1.9 (1.6–2.1)
Missing	0	0	1	1
RAQoL score				
Median (IQR)	22.0 (20.0–24.0)	21.5 (14.0–28.0)	21.0 (15.0–24.0)	21.6 (15.5–25.5)
Missing	0	0	1	1

continued

**TABLE 51** Baseline patient-reported outcomes: PP population (*continued*)

Patient-reported outcome	Treatment arm			Total (n = 41)
	Alternative TNFi (n = 13)	Abatacept (n = 14)	Rituximab (n = 14)	
HADS score				
Median (IQR)	13.0 (8.0–19.0)	16.0 (9.0–22.0)	11.0 (8.0–16.0)	13.0 (8.0–20.0)
Missing	0	0	1	1
HADS anxiety score				
Median (IQR)	6.0 (4.0–11.0)	8.5 (6.0–12.0)	5.0 (4.0–10.0)	6.5 (4.0–11.5)
Missing	0	0	1	1
HADS depression score				
Median (IQR)	6.0 (4.0–8.0)	7.5 (4.0–9.0)	6.0 (3.0–10.0)	6.0 (3.5–9.0)
Missing	0	0	1	1

IQR, interquartile range.

**TABLE 52** The DAS28 and corresponding improvement in DAS28 over 48 weeks: PP population

Visit	Treatment arm			Total (n = 41)
	Alternative TNFi (n = 13)	Abatacept (n = 14)	Rituximab (n = 14)	
<b>DAS28</b>				
Baseline				
Mean (SD)	5.3 (0.73)	6.2 (0.85)	6.6 (1.22)	6.0 (1.09)
Missing	0	0	1	1
12 weeks				
Mean (SD)	4.2 (0.97)	4.7 (1.20)	4.8 (1.27)	4.6 (1.16)
Missing	1	1	1	3
24 weeks				
Mean (SD)	3.9 (0.99)	4.6 (1.51)	4.4 (1.78)	4.3 (1.46)
Missing	0	1	1	2
36 weeks				
Mean (SD)	3.7 (0.99)	4.8 (1.44)	5.1 (1.36)	4.5 (1.40)
Missing	0	1	1	2
48 weeks				
Mean (SD)	3.8 (1.16)	4.5 (0.84)	5.0 (1.44)	4.5 (1.27)
Missing	3	3	1	7



**TABLE 52** The DAS28 and corresponding improvement in DAS28 over 48 weeks: PP population (*continued*)

Visit	Treatment arm			Total (n = 41)
	Alternative TNFi (n = 13)	Abatacept (n = 14)	Rituximab (n = 14)	
<b>DAS28 improvement</b>				
12 weeks				
Mean (SD)	1.0 (1.18)	1.5 (0.91)	1.5 (0.97)	1.4 (1.02)
Missing	1	1	2	4
24 weeks				
Mean (SD)	1.4 (1.08)	1.6 (1.37)	2.2 (1.75)	1.7 (1.42)
Missing	0	1	2	3
36 weeks				
Mean (SD)	1.6 (1.26)	1.5 (1.33)	1.5 (1.17)	1.5 (1.22)
Missing	0	1	1	2
48 weeks				
Mean (SD)	1.6 (1.58)	1.8 (0.83)	1.4 (1.40)	1.6 (1.27)
Missing	3	3	2	8



## Appendix 11 Supplementary baseline data

Baseline characteristic	Treatment arm, n (%)			Total (N = 122), n (%)
	Alternative TNFi (N = 41)	Abatacept (N = 41)	Rituximab (N = 40)	
<b>Centre name and number</b>				
Chapel Allerton Hospital, Leeds; N00482	10 (24.4)	11 (26.8)	11 (27.5)	32 (26.2)
Cannock Chase Hospital; N00473	2 (4.9)	2 (4.9)	4 (10.0)	8 (6.6)
Queen Elizabeth Hospital, Gateshead; N00071	2 (4.9)	1 (2.4)	3 (7.5)	6 (4.9)
Airedale General Hospital; N00074	2 (4.9)	3 (7.3)	1 (2.5)	6 (4.9)
Manchester Royal Infirmary; N00080	2 (4.9)	–	4 (10.0)	6 (4.9)
Derriford Hospital, Plymouth; N00118	2 (4.9)	3 (7.3)	1 (2.5)	6 (4.9)
King George Hospital, Ilford; N00165	2 (4.9)	2 (4.9)	2 (5.0)	6 (4.9)
Birmingham City Hospital; N00346	2 (4.9)	2 (4.9)	1 (2.5)	5 (4.1)
Royal National Hospital for Rheumatic Diseases, Bath; N02220	1 (2.4)	3 (7.3)	1 (2.5)	5 (4.1)
Leicester Royal Infirmary; N00031	1 (2.4)	2 (4.9)	1 (2.5)	4 (3.3)
Hull Royal Infirmary; N00078	1 (2.4)	1 (2.4)	2 (5.0)	4 (3.3)
Royal Hallamshire Hospital, Sheffield; N00093	2 (4.9)	1 (2.4)	1 (2.5)	4 (3.3)
Queen's Hospital, Burton upon Trent; N00178	2 (4.9)	2 (4.9)	–	4 (3.3)
New Cross Hospital, Wolverhampton; N00034	1 (2.4)	1 (2.4)	1 (2.5)	3 (2.5)
Northampton General Hospital; N00038	3 (7.3)	–	–	3 (2.5)
Poole Hospital; N00108	2 (4.9)	–	1 (2.5)	3 (2.5)
University Hospital, North Durham; N00170	–	1 (2.4)	2 (5.0)	3 (2.5)
Salford Royal Infirmary; N00400	1 (2.4)	1 (2.4)	1 (2.5)	3 (2.5)
Broadgreen Hospital, Liverpool; N00589	1 (2.4)	1 (2.4)	–	2 (1.6)
Darlington Memorial Hospital; N00068	–	1 (2.4)	–	1 (0.8)
Royal Victoria Infirmary, Newcastle upon Tyne; N00072	1 (2.4)	–	–	1 (0.8)
Harrogate District Hospital; N00076	–	–	1 (2.5)	1 (0.8)
Queen Alexandra Hospital, Portsmouth; N00110	–	–	1 (2.5)	1 (0.8)
Bristol Royal Infirmary; N00117	–	1 (2.4)	–	1 (0.8)
Royal Derby Hospital; N00168	–	1 (2.4)	–	1 (0.8)
Guy's Hospital, London; N00241	1 (2.4)	–	–	1 (0.8)
Nuffield Orthopaedic Centre, Oxford; N00282	–	–	1 (2.5)	1 (0.8)
Musgrove Park Hospital, Taunton; N00306	–	1 (2.4)	–	1 (0.8)

Baseline characteristic	Treatment arm, n (%)			Total (N = 122), n (%)
	Alternative TNFi (N = 41)	Abatacept (N = 41)	Rituximab (N = 40)	
<b>Previous DMARDs</b>				
Azathioprine				
Previously used, and stopped	4 (9.8)	3 (7.3)	–	7 (5.7)
Not used	36 (87.8)	38 (92.7)	39 (97.5)	113 (92.6)
Not known	1 (2.4)	–	1 (2.5)	2 (1.6)
Chloroquine				
Previously used, cessation unknown	1 (2.4)	–	–	1 (0.8)
Not used	39 (95.1)	41 (100.0)	39 (97.5)	119 (97.5)
Not known	1 (2.4)	–	1 (2.5)	2 (1.6)
Ciclosporin				
Previously used, and stopped	1 (2.4)	2 (4.9)	2 (5.0)	5 (4.1)
Not used	39 (95.1)	39 (95.1)	37 (92.5)	115 (94.3)
Not known	1 (2.4)	–	1 (2.5)	2 (1.6)
Hydroxychloroquine				
Previously used, and stopped	33 (80.5)	23 (56.1)	24 (60.0)	80 (65.6)
Previously used, but unwilling to stop	1 (2.4)	–	–	1 (0.8)
Previously used, cessation unknown	–	1 (2.4)	2 (5.0)	3 (2.5)
Not used	7 (17.1)	17 (41.5)	13 (32.5)	37 (30.3)
Not known	–	–	1 (2.5)	1 (0.8)
Leflunomide				
Previously used, and stopped	11 (26.8)	4 (9.8)	11 (27.5)	26 (21.3)
Not used	29 (70.7)	37 (90.2)	28 (70.0)	94 (77.0)
Not known	1 (2.4)	–	1 (2.5)	2 (1.6)
Oral/injectable gold				
Previously used, and stopped	2 (4.9)	2 (4.9)	2 (5.0)	6 (4.9)
Not used	38 (92.7)	39 (95.1)	37 (92.5)	114 (93.4)
Not known	1 (2.4)	–	1 (2.5)	2 (1.6)
Sulfasalazine				
Previously used, and stopped	23 (56.1)	32 (78.0)	34 (85.0)	89 (73.0)
Previously used, but unwilling to stop	1 (2.4)	–	–	1 (0.8)
Previously used, cessation unknown	–	1 (2.4)	–	1 (0.8)
Not used	16 (39.0)	8 (19.5)	6 (15.0)	30 (24.6)
Not known	1 (2.4)	–	–	1 (0.8)
Penicillamine				
Previously used, and stopped	–	2 (4.9)	1 (2.5)	3 (2.5)
Not used	41 (100.0)	39 (95.1)	39 (97.5)	119 (97.5)

Baseline characteristic	Treatment arm, n (%)			Total (N = 122), n (%)
	Alternative TNFi (N = 41)	Abatacept (N = 41)	Rituximab (N = 40)	
<b>Unknown DMARD</b>				
Previously used, and stopped	1 (2.4)	–	1 (2.5)	2 (1.6)
Not used	40 (97.6)	41 (100.0)	39 (97.5)	120 (98.4)
<b>Received steroids within 4 weeks of screening visit</b>				
None	32 (78.0)	33 (80.5)	33 (82.5)	98 (80.3)
Oral prednisolone	8 (19.5)	8 (19.5)	6 (15.0)	22 (18.0)
Intramuscular methylprednisolone	–	–	1 (2.5)	1 (0.8)
Intramuscular triamcinolone	1 (2.4)	–	–	1 (0.8)
<b>NSAIDs 4 weeks prior to screen</b>				
Yes	24 (58.5)	14 (34.1)	22 (55.0)	60 (49.2)
No	16 (39.0)	27 (65.9)	18 (45.0)	61 (50.0)
Missing	1 (2.4)	–	–	1 (0.8)



## Appendix 12 Secondary outcomes

**TABLE 53** Summaries of the reduction in the DAS28 at week 24 for each of the exploratory subgroups: complete-case population

Exploratory subgroup	Treatment arm			Total
	Alternative TNFi	Abatacept	Rituximab	
<b>RF/ACPA status</b>				
RF and ACPA seronegative	<i>n</i> = 5	<i>n</i> = 10	<i>n</i> = 7	<i>n</i> = 22
Mean (SD)	1.8 (1.63)	1.2 (2.05)	-0.2 (1.76)	1.0 (1.91)
Median (IQR)	1.0 (0.9 to 2.7)	1.3 (-0.1 to 2.5)	0.3 (-1.2 to 0.9)	1.0 (0.2 to 1.5)
Missing, <i>n</i>	1	2	3	6
RF or ACPA seropositive	<i>n</i> = 36	<i>n</i> = 31	<i>n</i> = 33	<i>n</i> = 100
Mean (SD)	1.4 (1.25)	1.2 (1.65)	1.5 (1.90)	1.4 (1.59)
Median (IQR)	1.6 (0.5 to 2.1)	1.2 (0.1 to 2.2)	1.4 (0.5 to 2.5)	1.4 (0.4 to 2.2)
Missing, <i>n</i>	4	5	5	14
<b>Initial alternative TNFi failed</b>				
Monoclonal antibody	<i>n</i> = 25	<i>n</i> = 23	<i>n</i> = 22	<i>n</i> = 70
Mean (SD)	1.3 (1.25)	0.9 (1.58)	1.1 (1.96)	1.1 (1.57)
Median (IQR)	1.4 (0.4 to 1.9)	0.7 (-0.4 to 1.7)	1.3 (0.4 to 1.9)	1.2 (0.3 to 1.9)
Missing, <i>n</i>	2	4	5	11
Etanercept	<i>n</i> = 16	<i>n</i> = 18	<i>n</i> = 18	<i>n</i> = 52
Mean (SD)	1.6 (1.36)	1.6 (1.85)	1.5 (1.97)	1.6 (1.72)
Median (IQR)	1.7 (0.9 to 2.2)	1.6 (0.4 to 2.6)	1.5 (-0.2 to 2.4)	1.6 (0.4 to 2.4)
Missing, <i>n</i>	3	3	3	9
<b>Initial non-responder status</b>				
Primary non-response	<i>n</i> = 15	<i>n</i> = 15	<i>n</i> = 15	<i>n</i> = 45
Mean (SD)	1.2 (1.51)	1.7 (2.14)	1.7 (1.78)	1.5 (1.76)
Median (IQR)	1.1 (0.3 to 2.2)	1.4 (0.0 to 3.3)	1.5 (0.1 to 3.2)	1.4 (0.3 to 2.6)
Missing, <i>n</i>	1	4	3	8
Secondary non-response	<i>n</i> = 26	<i>n</i> = 26	<i>n</i> = 25	<i>n</i> = 77
Mean (SD)	1.5 (1.13)	1.0 (1.48)	1.1 (2.05)	1.2 (1.57)
Median (IQR)	1.6 (0.9 to 2.1)	1.2 (-0.2 to 1.8)	0.9 (0.3 to 1.8)	1.3 (0.3 to 2.0)
Missing, <i>n</i>	4	3	5	12

IQR, interquartile range.

**TABLE 54** Frequency of patients achieving a DAS28 response (a reduction of 1.2 units or more from baseline) over 48 weeks: complete-case population

Visit	Treatment arm, n/N (%)			Total, n/N (%)
	Alternative TNFi	Abatacept	Rituximab	
Week 12	14/34 (41.2)	19/35 (54.3)	16/34 (47.1)	49/103 (47.6)
Week 24	21/36 (58.3)	17/34 (50.0)	17/32 (53.1)	55/102 (53.9)
Week 36	18/34 (52.9)	16/31 (51.6)	15/29 (51.7)	49/94 (52.1)
Week 48	19/30 (63.3)	18/30 (60.0)	13/23 (56.5)	50/83 (60.2)

**TABLE 55** Covariance matrix of the unstructured covariance (95% CI) from mixed-effects model for the DAS28 over 48 weeks

Visit	Time point			
	12 weeks	24 weeks	36 weeks	48 weeks
12 weeks	2.11 (1.56 to 2.66)			
24 weeks	1.04 (0.63 to 1.44)	1.69 (1.23 to 2.15)		
36 weeks	0.82 (0.38 to 1.25)	1.05 (0.64 to 1.47)	1.90 (1.36 to 2.44)	
48 weeks	0.72 (0.38 to 1.07)	0.83 (0.49 to 1.16)	0.74 (0.39 to 1.08)	1.38 (1.00 to 1.75)

**TABLE 56** Covariance matrix of the unstructured covariance (95% CI) from mixed-effects model for DAS28 response over 48 weeks

Visit	Time point			
	12 weeks	24 weeks	36 weeks	48 weeks
12 weeks	1.03 (0.75 to 1.30)			
24 weeks	0.40 (0.18 to 0.63)	1.08 (0.79 to 1.37)		
36 weeks	0.28 (0.07 to 0.50)	0.27 (0.06 to 0.47)	0.95 (0.70 to 1.21)	
48 weeks	0.48 (0.26 to 0.70)	0.44 (0.21 to 0.68)	0.20 (0.00 to 0.40)	1.09 (0.80 to 1.38)



**TABLE 57** Frequency of patients achieving ACR20, ACR50 or ACR70 response at each follow-up until week 48: complete-case population

Visit	Treatment arm, n/N (%)			Total, n/N (%)
	Alternative TNFi	Abatacept	Rituximab	
<b>ACR20</b>				
Week 12	12/37 (32.4)	16/37 (43.2)	14/37 (37.8)	42/111 (37.8)
Week 24	16/36 (44.4)	11/35 (31.4)	10/37 (27.0)	37/108 (34.3)
Week 36	16/34 (47.1)	12/32 (37.5)	11/32 (34.4)	39/98 (39.8)
Week 48	17/31 (54.8)	11/31 (35.5)	12/28 (42.9)	40/90 (44.4)
<b>ACR50</b>				
Week 12	6/37 (16.2)	5/37 (13.5)	3/39 (7.7)	14/113 (12.4)
Week 24	8/37 (21.6)	7/36 (19.4)	3/38 (7.9)	18/111 (16.2)
Week 36	7/34 (20.6)	6/32 (18.8)	3/33 (9.1)	16/99 (16.2)
Week 48	9/31 (29.0)	6/32 (18.8)	6/29 (20.7)	21/92 (22.8)
<b>ACR70</b>				
Week 12	1/37 (2.7)	1/39 (2.6)	0/40 (0.0)	2/116 (1.7)
Week 24	3/37 (8.1)	3/36 (8.3)	2/38 (5.3)	8/111 (7.2)
Week 36	6/34 (17.6)	4/32 (12.5)	0/34 (0.0)	10/100 (10.0)
Week 48	5/31 (16.1)	3/32 (9.4)	3/30 (10.0)	11/93 (11.8)

**TABLE 58** Summary statistics of the DAS28 and reduction in the DAS28 over time

Visit	Treatment arm			Total (n = 122)
	Alternative TNFi (n = 41)	Abatacept (n = 41)	Rituximab (n = 40)	
<b>DAS28</b>				
<b>Baseline</b>				
Mean score (SD)	5.9 (1.05)	6.2 (1.08)	6.2 (1.28)	6.1 (1.13)
Missing, n	1	3	5	9
<b>12 weeks</b>				
Mean score (SD)	4.7 (1.33)	5.0 (1.34)	5.0 (1.22)	4.9 (1.29)
Missing, n	7	4	2	13
<b>24 weeks</b>				
Mean score (SD)	4.3 (1.32)	4.9 (1.60)	4.9 (1.55)	4.7 (1.51)
Missing, n	5	4	3	12
<b>36 weeks</b>				
Mean score (SD)	4.0 (1.35)	4.9 (1.47)	4.9 (1.25)	4.6 (1.41)
Missing, n	7	8	9	24
<b>48 weeks</b>				
Mean score (SD)	4.1 (1.58)	4.8 (1.24)	4.8 (1.42)	4.6 (1.44)
Missing, n	11	8	13	32

continued

**TABLE 58** Summary statistics of the DAS28 and reduction in the DAS28 over time (*continued*)

Visit	Treatment arm			Total ( <i>n</i> = 122)
	Alternative TNFi ( <i>n</i> = 41)	Abatacept ( <i>n</i> = 41)	Rituximab ( <i>n</i> = 40)	
60 weeks				
Mean score (SD)	3.5 (1.40)	4.1 (1.44)	4.8 (1.19)	4.1 (1.42)
Missing, <i>n</i>	27	26	29	82
72 weeks				
Mean score (SD)	3.4 (1.71)	4.9 (1.47)	4.9 (0.93)	4.5 (1.53)
Missing, <i>n</i>	33	28	32	93
84 weeks				
Mean score (SD)	3.3 (1.46)	3.8 (1.48)	5.1 (1.28)	4.1 (1.54)
Missing, <i>n</i>	35	34	34	103
96 weeks				
Mean score (SD)	2.6 (1.52)	3.2 (1.34)	4.8 (2.07)	3.3 (1.73)
Missing, <i>n</i>	36	37	37	110
<b>Absolute reduction in the DAS28</b>				
12 weeks				
Mean reduction in score (SD)	1.1 (1.30)	1.3 (1.27)	1.1 (1.16)	1.1 (1.24)
Missing, <i>n</i>	7	6	6	19
24 weeks				
Mean reduction in score (SD)	1.4 (1.28)	1.2 (1.72)	1.3 (1.94)	1.3 (1.64)
Missing, <i>n</i>	5	7	8	20
36 weeks				
Mean reduction in score (SD)	1.6 (1.36)	1.2 (1.68)	1.2 (1.18)	1.3 (1.42)
Missing, <i>n</i>	7	10	11	28
48 weeks				
Mean reduction in score (SD)	1.6 (1.64)	1.4 (1.38)	1.2 (1.49)	1.4 (1.50)
Missing, <i>n</i>	11	11	17	39
60 weeks				
Mean reduction in score (SD)	2.1 (1.37)	2.3 (1.31)	1.3 (1.89)	2.0 (1.52)
Missing, <i>n</i>	27	28	30	85
72 weeks				
Mean reduction in score (SD)	2.4 (1.53)	1.4 (1.28)	1.1 (2.18)	1.7 (1.63)
Missing, <i>n</i>	33	31	34	98
84 weeks				
Mean reduction in score (SD)	2.6 (1.10)	1.3 (1.57)	2.1 (1.04)	2.1 (1.25)
Missing, <i>n</i>	35	37	35	107
96 weeks				
Mean reduction in score (SD)	3.3 (1.18)	3.0 (–)	2.3 (1.58)	3.0 (1.16)
Missing, <i>n</i>	36	40	38	114

TABLE 59 The DAS28 category over time

DAS28 category	Treatment arm, n (%)			Total (N = 122), n (%)
	Alternative TNFi (N = 41)	Abatacept (N = 41)	Rituximab (N = 40)	
Baseline				
High disease activity (DAS28)	33 (80.5)	32 (78.0)	28 (70.0)	93 (76.2)
Moderate disease activity (DAS28)	7 (17.1)	6 (14.6)	7 (17.5)	20 (16.4)
Missing	1 (2.4)	3 (7.3)	5 (12.5)	9 (7.4)
12 weeks				
High disease activity (DAS28)	11 (26.8)	16 (39.0)	18 (45.0)	45 (36.9)
Moderate disease activity (DAS28)	19 (46.3)	18 (43.9)	17 (42.5)	54 (44.3)
Low disease activity (DAS28)	3 (7.3)	2 (4.9)	2 (5.0)	7 (5.7)
Remission (DAS28)	1 (2.4)	1 (2.4)	1 (2.5)	3 (2.5)
Missing	7 (17.1)	4 (9.8)	2 (5.0)	13 (10.7)
24 weeks				
High disease activity (DAS28)	9 (22.0)	15 (36.6)	20 (50.0)	44 (36.1)
Moderate disease activity (DAS28)	19 (46.3)	16 (39.0)	9 (22.5)	44 (36.1)
Low disease activity (DAS28)	4 (9.8)	3 (7.3)	4 (10.0)	11 (9.0)
Remission (DAS28)	4 (9.8)	3 (7.3)	4 (10.0)	11 (9.0)
Missing	5 (12.2)	4 (9.8)	3 (7.5)	12 (9.8)
36 weeks				
High disease activity (DAS28)	7 (17.1)	17 (41.5)	15 (37.5)	39 (32.0)
Moderate disease activity (DAS28)	17 (41.5)	12 (29.3)	13 (32.5)	42 (34.4)
Low disease activity (DAS28)	5 (12.2)	2 (4.9)	1 (2.5)	8 (6.6)
Remission (DAS28)	5 (12.2)	2 (4.9)	2 (5.0)	9 (7.4)
Missing	7 (17.1)	8 (19.5)	9 (22.5)	24 (19.7)
48 weeks				
High disease activity (DAS28)	8 (19.5)	14 (34.1)	14 (35.0)	36 (29.5)
Moderate disease activity (DAS28)	11 (26.8)	16 (39.0)	10 (25.0)	37 (30.3)
Low disease activity (DAS28)	6 (14.6)	1 (2.4)	1 (2.5)	8 (6.6)
Remission (DAS28)	5 (12.2)	2 (4.9)	2 (5.0)	9 (7.4)
Missing	11 (26.8)	8 (19.5)	13 (32.5)	32 (26.2)
60 weeks				
High disease activity (DAS28)	1 (2.4)	5 (12.2)	4 (10.0)	10 (8.2)
Moderate disease activity (DAS28)	7 (17.1)	5 (12.2)	6 (15.0)	18 (14.8)
Low disease activity (DAS28)	2 (4.9)	1 (2.4)	1 (2.5)	4 (3.3)
Remission (DAS28)	4 (9.8)	4 (9.8)	–	8 (6.6)
Missing	27 (65.9)	26 (63.4)	29 (72.5)	82 (67.2)

continued

TABLE 59 The DAS28 category over time (continued)

DAS28 category	Treatment arm, n (%)			Total (N = 122), n (%)
	Alternative TNFi (N = 41)	Abatacept (N = 41)	Rituximab (N = 40)	
72 weeks				
High disease activity (DAS28)	1 (2.4)	5 (12.2)	3 (7.5)	9 (7.4)
Moderate disease activity (DAS28)	2 (4.9)	6 (14.6)	5 (12.5)	13 (10.7)
Low disease activity (DAS28)	2 (4.9)	1 (2.4)	–	3 (2.5)
Remission (DAS28)	3 (7.3)	1 (2.4)	–	4 (3.3)
Missing	33 (80.5)	28 (68.3)	32 (80.0)	93 (76.2)
84 weeks				
High disease activity (DAS28)	–	2 (4.9)	4 (10.0)	6 (4.9)
Moderate disease activity (DAS28)	3 (7.3)	3 (7.3)	1 (2.5)	7 (5.7)
Low disease activity (DAS28)	1 (2.4)	–	1 (2.5)	2 (1.6)
Remission (DAS28)	2 (4.9)	2 (4.9)	–	4 (3.3)
Missing	35 (85.4)	34 (82.9)	34 (85.0)	103 (84.4)
96 weeks				
High disease activity (DAS28)	–	–	2 (5.0)	2 (1.6)
Moderate disease activity (DAS28)	1 (2.4)	3 (7.3)	–	4 (3.3)
Low disease activity (DAS28)	1 (2.4)	–	–	1 (0.8)
Remission (DAS28)	3 (7.3)	1 (2.4)	1 (2.5)	5 (4.1)
Missing	36 (87.8)	37 (90.2)	37 (92.5)	110 (90.2)

TABLE 60 The EULAR response over time

EULAR response category	Treatment arm, n (%)			Total (N = 122), n (%)
	Alternative TNFi (N = 41)	Abatacept (N = 41)	Rituximab (N = 40)	
12 weeks				
Good response	4 (9.8)	3 (7.3)	1 (2.5)	8 (6.6)
Moderate response	13 (31.7)	18 (43.9)	20 (50.0)	51 (41.8)
No response	17 (41.5)	14 (34.1)	13 (32.5)	44 (36.1)
Missing	7 (17.1)	6 (14.6)	6 (15.0)	19 (15.6)
24 weeks				
Good response	8 (19.5)	5 (12.2)	7 (17.5)	20 (16.4)
Moderate response	18 (43.9)	15 (36.6)	13 (32.5)	46 (37.7)
No response	10 (24.4)	14 (34.1)	12 (30.0)	36 (29.5)
Missing	5 (12.2)	7 (17.1)	8 (20.0)	20 (16.4)

TABLE 60 The EULAR response over time (continued)

EULAR response category	Treatment arm, n (%)			Total (N = 122), n (%)
	Alternative TNFi (N = 41)	Abatacept (N = 41)	Rituximab (N = 40)	
36 weeks				
Good response	9 (22.0)	3 (7.3)	3 (7.5)	15 (12.3)
Moderate response	15 (36.6)	14 (34.1)	13 (32.5)	42 (34.4)
No response	10 (24.4)	14 (34.1)	13 (32.5)	37 (30.3)
Missing	7 (17.1)	10 (24.4)	11 (27.5)	28 (23.0)
48 weeks				
Good response	11 (26.8)	2 (4.9)	2 (5.0)	15 (12.3)
Moderate response	8 (19.5)	18 (43.9)	12 (30.0)	38 (31.1)
No response	11 (26.8)	10 (24.4)	9 (22.5)	30 (24.6)
Missing	11 (26.8)	11 (26.8)	17 (42.5)	39 (32.0)
60 weeks				
Good response	6 (14.6)	4 (9.8)	–	10 (8.2)
Moderate response	5 (12.2)	7 (17.1)	6 (15.0)	18 (14.8)
No response	3 (7.3)	2 (4.9)	4 (10.0)	9 (7.4)
Missing	27 (65.9)	28 (68.3)	30 (75.0)	85 (69.7)
72 weeks				
Good response	5 (12.2)	1 (2.4)	–	6 (4.9)
Moderate response	2 (4.9)	5 (12.2)	3 (7.5)	10 (8.2)
No response	1 (2.4)	4 (9.8)	3 (7.5)	8 (6.6)
Missing	33 (80.5)	31 (75.6)	34 (85.0)	98 (80.3)
84 weeks				
Good response	3 (7.3)	–	1 (2.5)	4 (3.3)
Moderate response	3 (7.3)	2 (4.9)	3 (7.5)	8 (6.6)
No response	–	2 (4.9)	1 (2.5)	3 (2.5)
Missing	35 (85.4)	37 (90.2)	35 (87.5)	107 (87.7)
96 weeks				
Good response	4 (9.8)	–	1 (2.5)	5 (4.1)
Moderate response	1 (2.4)	1 (2.4)	1 (2.5)	3 (2.5)
Missing	36 (87.8)	40 (97.6)	38 (95.0)	114 (93.4)

TABLE 61 The ACR/EULAR Boolean remission response over time

ACR/EULAR Boolean remission	Treatment arm, <i>n</i> (%)			Total ( <i>N</i> = 122), <i>n</i> (%)
	Alternative TNFi ( <i>N</i> = 41)	Abatacept ( <i>N</i> = 41)	Rituximab ( <i>N</i> = 40)	
Baseline				
No	39 (95.1)	38 (92.7)	35 (87.5)	112 (91.8)
Missing	2 (4.9)	3 (7.3)	5 (12.5)	10 (8.2)
12 weeks				
No	31 (75.6)	38 (92.7)	38 (95.0)	107 (87.7)
Missing	10 (24.4)	3 (7.3)	2 (5.0)	15 (12.3)
24 weeks				
Yes	2 (4.9)	1 (2.4)	–	3 (2.5)
No	32 (78.0)	36 (87.8)	36 (90.0)	104 (85.2)
Missing	7 (17.1)	4 (9.8)	4 (10.0)	15 (12.3)
36 weeks				
Yes	2 (4.9)	–	–	2 (1.6)
No	30 (73.2)	34 (82.9)	34 (85.0)	98 (80.3)
Missing	9 (22.0)	7 (17.1)	6 (15.0)	22 (18.0)
48 weeks				
Yes	1 (2.4)	1 (2.4)	–	2 (1.6)
No	30 (73.2)	31 (75.6)	28 (70.0)	89 (73.0)
Missing	10 (24.4)	9 (22.0)	12 (30.0)	31 (25.4)
60 weeks				
Yes	1 (2.4)	2 (4.9)	–	3 (2.5)
No	12 (29.3)	13 (31.7)	11 (27.5)	36 (29.5)
Missing	28 (68.3)	26 (63.4)	29 (72.5)	83 (68.0)
72 weeks				
Yes	1 (2.4)	–	–	1 (0.8)
No	6 (14.6)	13 (31.7)	7 (17.5)	26 (21.3)
Missing	34 (82.9)	28 (68.3)	33 (82.5)	95 (77.9)
84 weeks				
Yes	1 (2.4)	–	–	1 (0.8)
No	5 (12.2)	7 (17.1)	4 (10.0)	16 (13.1)
Missing	35 (85.4)	34 (82.9)	36 (90.0)	105 (86.1)
96 weeks				
Yes	1 (2.4)	1 (2.4)	–	2 (1.6)
No	4 (9.8)	3 (7.3)	3 (7.5)	10 (8.2)
Missing	36 (87.8)	37 (90.2)	37 (92.5)	110 (90.2)

TABLE 62 Clinical Disease Activity Index, change in CDAI over time

Visit	Treatment arm			Total (n = 122)
	Alternative TNFi (n = 41)	Abatacept (n = 41)	Rituximab (n = 40)	
<b>CDAI score</b>				
Baseline				
Median score (IQR)	38.7 (27.8 to 46.5)	37.4 (28.3 to 47.9)	39.3 (29.3 to 51.0)	38.2 (28.8 to 48.0)
Missing, n	1	3	4	8
12 weeks				
Median score (IQR)	18.5 (11.8 to 37.2)	17.8 (10.2 to 36.7)	22.0 (13.6 to 30.2)	21.2 (12.5 to 35.7)
Missing, n	6	2	2	10
24 weeks				
Median score (IQR)	15.4 (9.1 to 28.5)	22.1 (8.9 to 36.4)	23.5 (12.2 to 36.1)	20.8 (9.8 to 32.4)
Missing, n	6	5	5	16
36 weeks				
Median score (IQR)	14.6 (9.2 to 28.8)	24.1 (8.5 to 32.3)	20.6 (13.9 to 30.6)	18.8 (9.6 to 30.4)
Missing, n	8	8	6	22
48 weeks				
Median score (IQR)	19.3 (5.4 to 25.3)	17.2 (13.5 to 25.6)	19.7 (10.8 to 30.9)	17.7 (9.9 to 28.1)
Missing, n	10	9	12	31
60 weeks				
Median score (IQR)	16.9 (3.4 to 29.8)	13.1 (6.1 to 26.7)	16.1 (10.5 to 30.9)	16.1 (6.1 to 28.5)
Missing, n	27	27	29	83
72 weeks				
Median score (IQR)	7.7 (4.3 to 25.7)	18.4 (14.6 to 33.5)	15.1 (12.8 to 31.2)	15.5 (9.9 to 33.5)
Missing, n	33	29	32	94
84 weeks				
Median score (IQR)	7.6 (3.9 to 17.1)	11.8 (5.0 to 31.8)	28.5 (11.4 to 30.9)	12.6 (4.1 to 29.7)
Missing, n	34	33	35	102
96 weeks				
Median score (IQR)	2.6 (1.2 to 14.0)	8.3 (5.4 to 15.1)	28.7 (11.4 to 33.6)	10.4 (3.0 to 24.8)
Missing, n	36	37	37	110
<b>Change in CDAI score</b>				
12 weeks				
Median change in score (IQR)	-12.4 (-21.4 to -1.6)	-15.6 (-22.6 to -6.8)	-16.2 (-26.5 to -5.8)	-14.6 (-23.1 to -5.7)
Missing, n	6	5	4	15

continued

TABLE 62 Clinical Disease Activity Index, change in CDAI over time (continued)

Visit	Treatment arm			Total (n = 122)
	Alternative TNFi (n = 41)	Abatacept (n = 41)	Rituximab (n = 40)	
24 weeks				
Median change in score (IQR)	-17.8 (-25.7 to -10.6)	-14.7 (-22.3 to 0.4)	-17.0 (-25.1 to -4.9)	-16.1 (-24.8 to -4.5)
Missing, n	6	8	8	22
36 weeks				
Median change in score (IQR)	-17.5 (-23.3 to -11.7)	-15.5 (-24.1 to 0.6)	-19.0 (-26.7 to -8.0)	-17.7 (-24.8 to -6.6)
Missing	8	11	8	27
48 weeks				
Median change in score (IQR)	-19.3 (-28.8 to -5.7)	-14.1 (-29.2 to -5.9)	-20.3 (-32.3 to -5.3)	-18.5 (-29.2 to -5.7)
Missing, n	10	12	15	37
60 weeks				
Median change in score (IQR)	-19.5 (-27.7 to -10.0)	-20.5 (-31.6 to -7.7)	-12.8 (-38.8 to -9.9)	-19.5 (-31.0 to -9.9)
Missing, n	27	27	29	83
72 weeks				
Median change in score (IQR)	-20.0 (-28.4 to -11.1)	-9.3 (-17.3 to -2.1)	-13.3 (-27.0 to -0.7)	-14.5 (-26.3 to -4.5)
Missing, n	33	30	33	96
84 weeks				
Median change in score (IQR)	-20.6 (-27.7 to -15.5)	-9.9 (-25.5 to 5.8)	-23.5 (-30.0 to -7.6)	-19.1 (-27.7 to -2.7)
Missing, n	34	34	35	103
96 weeks				
Median change in score (IQR)	-25.2 (-32.7 to -19.1)	1.2 (-16.3 to 4.1)	-12.9 (-18.5 to 1.0)	-16.3 (-25.2 to 1.0)
Missing, n	36	38	37	111

IQR, interquartile range.

**Note**

Negative change values indicate lower disease activity and an improvement in the patient's condition.



TABLE 63 Clinical Disease Activity Index response over time

CDAI category	Treatment arm, n (%)			Total (N = 122), n (%)
	Alternative TNFi (N = 41)	Abatacept (N = 41)	Rituximab (N = 40)	
Baseline				
High disease activity	36 (87.8)	32 (78.0)	32 (80.0)	100 (82.0)
Moderate disease activity	4 (9.8)	5 (12.2)	4 (10.0)	13 (10.7)
Low disease activity	–	1 (2.4)	–	1 (0.8)
Missing	1 (2.4)	3 (7.3)	4 (10.0)	8 (6.6)
12 weeks				
High disease activity	15 (36.6)	18 (43.9)	18 (45.0)	51 (41.8)
Moderate disease activity	16 (39.0)	12 (29.3)	14 (35.0)	42 (34.4)
Low disease activity	4 (9.8)	8 (19.5)	6 (15.0)	18 (14.8)
Remission	–	1 (2.4)	–	1 (0.8)
Missing	6 (14.6)	2 (4.9)	2 (5.0)	10 (8.2)
24 weeks				
High disease activity	13 (31.7)	18 (43.9)	19 (47.5)	50 (41.0)
Moderate disease activity	13 (31.7)	6 (14.6)	10 (25.0)	29 (23.8)
Low disease activity	7 (17.1)	11 (26.8)	4 (10.0)	22 (18.0)
Remission	2 (4.9)	1 (2.4)	2 (5.0)	5 (4.1)
Missing	6 (14.6)	5 (12.2)	5 (12.5)	16 (13.1)
36 weeks				
High disease activity	13 (31.7)	18 (43.9)	15 (37.5)	46 (37.7)
Moderate disease activity	6 (14.6)	6 (14.6)	14 (35.0)	26 (21.3)
Low disease activity	11 (26.8)	6 (14.6)	5 (12.5)	22 (18.0)
Remission	3 (7.3)	3 (7.3)	–	6 (4.9)
Missing	8 (19.5)	8 (19.5)	6 (15.0)	22 (18.0)
48 weeks				
High disease activity	11 (26.8)	11 (26.8)	13 (32.5)	35 (28.7)
Moderate disease activity	10 (24.4)	14 (34.1)	9 (22.5)	33 (27.0)
Low disease activity	8 (19.5)	6 (14.6)	5 (12.5)	19 (15.6)
Remission	2 (4.9)	1 (2.4)	1 (2.5)	4 (3.3)
Missing	10 (24.4)	9 (22.0)	12 (30.0)	31 (25.4)
60 weeks				
High disease activity	6 (14.6)	5 (12.2)	4 (10.0)	15 (12.3)
Moderate disease activity	2 (4.9)	2 (4.9)	5 (12.5)	9 (7.4)
Low disease activity	3 (7.3)	5 (12.2)	2 (5.0)	10 (8.2)
Remission	3 (7.3)	2 (4.9)	–	5 (4.1)
Missing	27 (65.9)	27 (65.9)	29 (72.5)	83 (68.0)

continued

**TABLE 63** Clinical Disease Activity Index response over time (*continued*)

CDAI category	Treatment arm, <i>n</i> (%)			Total ( <i>N</i> = 122), <i>n</i> (%)
	Alternative TNFi ( <i>N</i> = 41)	Abatacept ( <i>N</i> = 41)	Rituximab ( <i>N</i> = 40)	
72 weeks				
High disease activity	2 (4.9)	5 (12.2)	3 (7.5)	10 (8.2)
Moderate disease activity	2 (4.9)	5 (12.2)	4 (10.0)	11 (9.0)
Low disease activity	3 (7.3)	2 (4.9)	1 (2.5)	6 (4.9)
Remission	1 (2.4)	–	–	1 (0.8)
Missing	33 (80.5)	29 (70.7)	32 (80.0)	94 (77.0)
84 weeks				
High disease activity	1 (2.4)	3 (7.3)	3 (7.5)	7 (5.7)
Moderate disease activity	2 (4.9)	1 (2.4)	1 (2.5)	4 (3.3)
Low disease activity	3 (7.3)	3 (7.3)	–	6 (4.9)
Remission	1 (2.4)	1 (2.4)	1 (2.5)	3 (2.5)
Missing	34 (82.9)	33 (80.5)	35 (87.5)	102 (83.6)
96 weeks				
High disease activity	1 (2.4)	–	2 (5.0)	3 (2.5)
Moderate disease activity	1 (2.4)	1 (2.4)	1 (2.5)	3 (2.5)
Low disease activity	–	3 (7.3)	–	3 (2.5)
Remission	3 (7.3)	–	–	3 (2.5)
Missing	36 (87.8)	37 (90.2)	37 (92.5)	110 (90.2)

**TABLE 64** Simplified Disease Activity Index, change in SDAI over time

Visit	Treatment arm			Total ( <i>n</i> = 122)
	Alternative TNFi ( <i>n</i> = 41)	Abatacept ( <i>n</i> = 41)	Rituximab ( <i>n</i> = 40)	
<b>SDAI score</b>				
Baseline				
Median score (IQR)	39.8 (27.9 to 47.5)	38.0 (29.7 to 50.4)	40.6 (29.9 to 52.4)	39.8 (29.5 to 51.4)
Missing, <i>n</i>	2	5	5	12
12 weeks				
Median score (IQR)	19.4 (12.3 to 38.6)	19.1 (12.1 to 37.5)	23.3 (15.8 to 36.1)	21.0 (13.0 to 37.5)
Missing, <i>n</i>	11	3	3	17
24 weeks				
Median score (IQR)	15.9 (9.6 to 30.7)	23.1 (9.9 to 38.2)	23.9 (12.7 to 39.8)	21.6 (9.9 to 35.1)
Missing, <i>n</i>	8	5	6	19

**TABLE 64** Simplified Disease Activity Index, change in SDAI over time (*continued*)

Visit	Treatment arm			Total (n = 122)
	Alternative TNFi (n = 41)	Abatacept (n = 41)	Rituximab (n = 40)	
36 weeks				
Median score (IQR)	14.7 (9.5 to 29.1)	24.6 (9.5 to 35.4)	21.4 (14.4 to 31.6)	19.9 (10.2 to 31.6)
Missing, n	10	8	6	24
48 weeks				
Median score (IQR)	19.8 (6.0 to 25.7)	19.2 (14.1 to 31.3)	20.3 (12.0 to 32.1)	19.4 (11.1 to 29.8)
Missing, n	10	10	12	32
60 weeks				
Median score (IQR)	23.0 (4.8 to 30.3)	17.2 (6.8 to 28.7)	16.6 (11.0 to 31.8)	17.2 (8.0 to 30.3)
Missing, n	28	28	29	85
72 weeks				
Median score (IQR)	11.0 (5.1 to 41.1)	21.6 (16.1 to 39.0)	19.3 (11.7 to 38.0)	18.7 (11.0 to 38.0)
Missing, n	34	29	33	96
84 weeks				
Median score (IQR)	12.7 (4.4 to 19.6)	10.3 (4.1 to 37.1)	30.5 (20.5 to 36.6)	17.2 (6.3 to 31.9)
Missing, n	35	34	36	105
96 weeks				
Median score (IQR)	3.1 (1.7 to 14.5)	8.8 (5.7 to 15.6)	29.2 (11.5 to 35.9)	10.6 (3.3 to 25.3)
Missing, n	36	37	37	110
<b>Change in SDAI score</b>				
12 weeks				
Median change in score (IQR)	-13.6 (-21.4 to 2.7)	-14.9 (-23.1 to -8.5)	-17.2 (-27.4 to -6.0)	-15.1 (-24.3 to -5.3)
Missing, n	12	8	6	26
24 weeks				
Median change in score (IQR)	-18.2 (-26.7 to -9.3)	-14.9 (-22.5 to -0.5)	-18.2 (-27.3 to -5.2)	-16.6 (-25.7 to -5.0)
Missing, n	9	10	9	28
36 weeks				
Median change in score (IQR)	-19.9 (-24.7 to -11.8)	-15.0 (-23.5 to 0.6)	-19.7 (-28.0 to -8.7)	-18.2 (-25.5 to -6.7)
Missing, n	11	12	9	32
48 weeks				
Median change in score (IQR)	-20.1 (-27.2 to -7.9)	-13.7 (-31.2 to -6.3)	-20.1 (-34.0 to -5.3)	-19.7 (-30.5 to -5.6)
Missing, n	11	15	15	41

continued

**TABLE 64** Simplified Disease Activity Index, change in SDAI over time (*continued*)

Visit	Treatment arm			Total ( <i>n</i> = 122)
	Alternative TNFi ( <i>n</i> = 41)	Abatacept ( <i>n</i> = 41)	Rituximab ( <i>n</i> = 40)	
60 weeks				
Median change in score (IQR)	-21.6 (-29.5 to -8.6)	-23.2 (-38.7 to -14.2)	-12.9 (-38.3 to -9.9)	-21.9 (-32.1 to -10.4)
Missing, <i>n</i>	29	30	29	88
72 weeks				
Median change in score (IQR)	-20.8 (-31.6 to -9.1)	-10.7 (-19.5 to -2.2)	-16.7 (-26.8 to -2.5)	-13.3 (-26.8 to -2.5)
Missing, <i>n</i>	34	31	34	99
84 weeks				
Median change in score (IQR)	-21.7 (-28.8 to -15.0)	-1.3 (-25.4 to 5.8)	-16.9 (-32.9 to -3.9)	-20.7 (-28.8 to -1.3)
Missing, <i>n</i>	35	36	36	107
96 weeks				
Median change in score (IQR)	-25.3 (-33.8 to -20.3)	-8.1 (-19.8 to 3.6)	-13.8 (-25.5 to 1.0)	-20.1 (-25.5 to -11.0)
Missing, <i>n</i>	36	39	37	112
IQR, interquartile range.				
<b>Note</b>				
Negative change values indicate lower disease activity and an improvement in the patient's condition.				

**TABLE 65** Simplified Disease Activity Index response over time

SDAI category	Treatment arm, <i>n</i> (%)			Total ( <i>N</i> = 122), <i>n</i> (%)
	Alternative TNFi ( <i>N</i> = 41)	Abatacept ( <i>N</i> = 41)	Rituximab ( <i>N</i> = 40)	
Baseline				
High disease activity	34 (82.9)	30 (73.2)	31 (77.5)	95 (77.9)
Moderate disease activity	5 (12.2)	5 (12.2)	4 (10.0)	14 (11.5)
Low disease activity	–	1 (2.4)	–	1 (0.8)
Missing	2 (4.9)	5 (12.2)	5 (12.5)	12 (9.8)
12 weeks				
High disease activity	12 (29.3)	16 (39.0)	14 (35.0)	42 (34.4)
Moderate disease activity	14 (34.1)	16 (39.0)	17 (42.5)	47 (38.5)
Low disease activity	4 (9.8)	5 (12.2)	6 (15.0)	15 (12.3)
Remission	–	1 (2.4)	–	1 (0.8)
Missing	11 (26.8)	3 (7.3)	3 (7.5)	17 (13.9)

TABLE 65 Simplified Disease Activity Index response over time (continued)

SDAI category	Treatment arm, n (%)			Total (N = 122), n (%)
	Alternative TNFi (N = 41)	Abatacept (N = 41)	Rituximab (N = 40)	
24 weeks				
High disease activity	11 (26.8)	17 (41.5)	13 (32.5)	41 (33.6)
Moderate disease activity	13 (31.7)	7 (17.1)	15 (37.5)	35 (28.7)
Low disease activity	7 (17.1)	11 (26.8)	4 (10.0)	22 (18.0)
Remission	2 (4.9)	1 (2.4)	2 (5.0)	5 (4.1)
Missing	8 (19.5)	5 (12.2)	6 (15.0)	19 (15.6)
36 weeks				
High disease activity	11 (26.8)	15 (36.6)	13 (32.5)	39 (32.0)
Moderate disease activity	8 (19.5)	9 (22.0)	16 (40.0)	33 (27.0)
Low disease activity	9 (22.0)	7 (17.1)	5 (12.5)	21 (17.2)
Remission	3 (7.3)	2 (4.9)	–	5 (4.1)
Missing	10 (24.4)	8 (19.5)	6 (15.0)	24 (19.7)
48 weeks				
High disease activity	7 (17.1)	8 (19.5)	10 (25.0)	25 (20.5)
Moderate disease activity	13 (31.7)	18 (43.9)	12 (30.0)	43 (35.2)
Low disease activity	9 (22.0)	4 (9.8)	5 (12.5)	18 (14.8)
Remission	2 (4.9)	1 (2.4)	1 (2.5)	4 (3.3)
Missing	10 (24.4)	10 (24.4)	12 (30.0)	32 (26.2)
60 weeks				
High disease activity	5 (12.2)	5 (12.2)	3 (7.5)	13 (10.7)
Moderate disease activity	3 (7.3)	3 (7.3)	5 (12.5)	11 (9.0)
Low disease activity	3 (7.3)	3 (7.3)	3 (7.5)	9 (7.4)
Remission	2 (4.9)	2 (4.9)	–	4 (3.3)
Missing	28 (68.3)	28 (68.3)	29 (72.5)	85 (69.7)
72 weeks				
High disease activity	2 (4.9)	5 (12.2)	2 (5.0)	9 (7.4)
Moderate disease activity	1 (2.4)	5 (12.2)	4 (10.0)	10 (8.2)
Low disease activity	3 (7.3)	2 (4.9)	1 (2.5)	6 (4.9)
Remission	1 (2.4)	–	–	1 (0.8)
Missing	34 (82.9)	29 (70.7)	33 (82.5)	96 (78.7)
84 weeks				
High disease activity	1 (2.4)	3 (7.3)	3 (7.5)	7 (5.7)
Moderate disease activity	2 (4.9)	–	1 (2.5)	3 (2.5)
Low disease activity	2 (4.9)	3 (7.3)	–	5 (4.1)
Remission	1 (2.4)	1 (2.4)	–	2 (1.6)
Missing	35 (85.4)	34 (82.9)	36 (90.0)	105 (86.1)

continued

**TABLE 65** Simplified Disease Activity Index response over time (*continued*)

SDAI category	Treatment arm, <i>n</i> (%)			Total ( <i>N</i> = 122), <i>n</i> (%)
	Alternative TNFi ( <i>N</i> = 41)	Abatacept ( <i>N</i> = 41)	Rituximab ( <i>N</i> = 40)	
96 weeks				
High disease activity	1 (2.4)	–	2 (5.0)	3 (2.5)
Moderate disease activity	1 (2.4)	1 (2.4)	1 (2.5)	3 (2.5)
Low disease activity	–	3 (7.3)	–	3 (2.5)
Remission	3 (7.3)	–	–	3 (2.5)
Missing	36 (87.8)	37 (90.2)	37 (92.5)	110 (90.2)

**TABLE 66** The HAQ-DI, RAQoL and HADS scores over time

Visit	Treatment arm			Total ( <i>n</i> = 122)
	Alternative TNFi ( <i>n</i> = 41)	Abatacept ( <i>n</i> = 41)	Rituximab ( <i>n</i> = 40)	
<b>HAQ-DI score</b>				
Baseline				
Median score (IQR)	1.9 (1.4–2.1)	1.9 (1.6–2.3)	1.9 (1.4–2.3)	1.9 (1.5–2.1)
Missing, <i>n</i>	1	1	1	3
12 weeks				
Median score (IQR)	1.8 (1.1–2.1)	1.7 (1.3–2.1)	1.8 (1.1–2.1)	1.8 (1.1–2.1)
Missing, <i>n</i>	4	2	0	6
24 weeks				
Median score (IQR)	1.6 (1.1–2.0)	1.8 (1.0–2.1)	1.7 (1.0–2.0)	1.6 (1.0–2.1)
Missing, <i>n</i>	5	4	2	11
36 weeks				
Median score (IQR)	1.6 (1.1–1.9)	1.7 (1.3–2.3)	1.5 (1.0–2.1)	1.6 (1.1–2.0)
Missing, <i>n</i>	7	7	6	20
48 weeks				
Median score (IQR)	1.5 (1.1–1.9)	1.6 (1.0–2.1)	1.7 (1.1–2.1)	1.6 (1.1–2.0)
Missing, <i>n</i>	11	7	10	28
60 weeks				
Median score (IQR)	1.6 (1.0–2.0)	1.8 (1.3–2.4)	1.6 (1.0–2.0)	1.6 (1.1–2.1)
Missing, <i>n</i>	27	24	30	81
72 weeks				
Median score (IQR)	1.3 (0.5–1.9)	1.6 (1.5–2.4)	1.4 (0.8–1.7)	1.6 (0.9–1.9)
Missing, <i>n</i>	33	28	32	93
84 weeks				
Median score (IQR)	1.8 (0.8–2.0)	1.4 (1.1–1.6)	1.5 (0.8–2.4)	1.4 (0.9–1.9)
Missing, <i>n</i>	34	32	34	100

TABLE 66 The HAQ-DI, RAQoL and HADS scores over time (continued)

Visit	Treatment arm			Total (n = 122)
	Alternative TNFi (n = 41)	Abatacept (n = 41)	Rituximab (n = 40)	
96 weeks				
Median score (IQR)	1.0 (0.4–2.0)	1.1 (0.8–1.1)	1.4 (0.4–2.5)	1.1 (0.4–1.7)
Missing, n	36	37	37	110
<b>RAQoL score</b>				
Baseline				
Median score (IQR)	21.6 (15.0–24.5)	22.0 (14.0–25.5)	22.0 (15.0–25.0)	22.0 (15.0–25.0)
Missing, n	1	1	2	4
12 weeks				
Median score (IQR)	19.0 (11.5–24.0)	17.0 (11.8–23.0)	19.0 (12.0–26.0)	18.5 (12.0–24.0)
Missing, n	5	2	1	8
24 weeks				
Median score (IQR)	18.0 (9.0–24.0)	20.5 (8.9–26.0)	20.0 (13.0–25.0)	19.0 (9.0–25.0)
Missing, n	6	7	2	15
36 weeks				
Median score (IQR)	17.3 (8.0–22.0)	16.8 (10.3–25.0)	18.0 (13.0–22.0)	17.5 (10.0–23.0)
Missing, n	7	7	7	21
48 weeks				
Median score (IQR)	19.0 (9.0–23.0)	17.5 (11.4–24.0)	19.5 (12.0–25.0)	18.4 (11.0–23.0)
Missing, n	11	7	10	28
<b>HADS total score</b>				
Baseline				
Median total score (IQR)	13.5 (8.0–20.0)	17.0 (10.0–22.0)	14.0 (11.0–19.0)	15.0 (10.0–21.0)
Missing, n	1	1	3	5
12 weeks				
Median total score (IQR)	12.0 (9.0–18.0)	13.0 (9.0–22.0)	13.5 (11.0–20.5)	13.0 (9.0–20.0)
Missing, n	4	3	0	7
24 weeks				
Median total score (IQR)	12.5 (6.0–18.5)	13.0 (8.0–17.0)	15.0 (10.0–20.0)	14.0 (8.0–19.0)
Missing, n	5	5	3	13
36 weeks				
Median total score (IQR)	9.5 (5.0–17.0)	13.0 (7.0–18.0)	13.0 (11.0–18.0)	13.0 (7.0–18.0)
Missing, n	7	8	6	21
48 weeks				
Median total score (IQR)	12.5 (4.0–19.0)	12.0 (7.0–16.0)	13.0 (10.0–20.0)	13.0 (7.0–19.0)
Missing, n	11	8	10	29

continued

TABLE 66 The HAQ-DI, RAQoL and HADS scores over time (continued)

Visit	Treatment arm			Total (n = 122)
	Alternative TNFi (n = 41)	Abatacept (n = 41)	Rituximab (n = 40)	
<b>HADS anxiety score</b>				
Baseline				
Median anxiety score (IQR)	7.0 (4.0–10.5)	9.0 (6.0–12.0)	8.0 (6.0–11.0)	8.0 (5.0–11.0)
Missing, n	1	1	3	5
12 weeks				
Median anxiety score (IQR)	6.0 (4.0–9.0)	7.0 (5.0–10.0)	8.0 (6.0–12.0)	7.0 (5.0–11.0)
Missing, n	4	3	0	7
24 weeks				
Median anxiety score (IQR)	6.0 (3.0–9.5)	6.0 (4.0–9.5)	8.0 (6.0–11.0)	7.0 (4.0–10.0)
Missing, n	5	5	3	13
36 weeks				
Median anxiety score (IQR)	6.0 (3.0–10.0)	6.0 (4.0–11.0)	8.0 (6.0–10.0)	7.0 (3.0–10.0)
Missing, n	7	8	6	21
48 weeks				
Median anxiety score (IQR)	6.0 (3.0–11.0)	7.0 (4.0–10.0)	8.0 (5.0–12.0)	7.0 (4.0–10.0)
Missing, n	11	8	10	29
<b>HADS depression score</b>				
Baseline				
Median depression score (IQR)	6.5 (4.0–9.0)	7.0 (4.0–10.0)	6.0 (4.0–9.0)	6.0 (4.0–9.0)
Missing, n	1	1	3	5
12 weeks				
Median depression score (IQR)	6.0 (3.0–8.0)	7.0 (4.0–9.0)	6.0 (4.0–9.0)	6.0 (4.0–9.0)
Missing, n	4	3	0	7
24 weeks				
Median depression score (IQR)	6.0 (2.0–9.5)	6.0 (2.5–9.0)	6.0 (3.0–9.0)	6.0 (3.0–9.0)
Missing, n	5	5	3	13
36 weeks				
Median depression score (IQR)	4.0 (2.0–8.0)	5.0 (4.0–8.0)	5.5 (4.0–8.0)	5.0 (3.0–8.0)
Missing, n	7	8	6	21
48 weeks				
Median depression score (IQR)	4.5 (2.0–9.0)	5.0 (3.0–7.0)	5.5 (4.0–9.0)	5.0 (3.0–9.0)
Missing, n	11	8	10	29

IQR, interquartile range.

**Note**

Higher scores correspond to a higher extent of disability in the HAQ-DI, lower quality of life in the RAQoL and higher level of anxiety and depression in the HADS.



**TABLE 67** Patient global assessment of pain, arthritis and general health over time

Visit	Treatment arm			Total (n = 122)
	Alternative TNFi (n = 41)	Abatacept (n = 41)	Rituximab (n = 40)	
<b>Patient Global Assessment of Pain VAS</b>				
Baseline				
Median, mm (IQR)	70.5 (59.0–82.5)	69.5 (57.5–79.0)	77.0 (55.0–85.0)	71.0 (58.0–81.0)
Missing, n	1	1	3	5
12 weeks				
Median, mm (IQR)	47.5 (27.0–64.0)	42.0 (22.0–63.0)	50.0 (39.0–79.0)	47.5 (30.0–70.0)
Missing, n	5	2	1	8
24 weeks				
Median, mm (IQR)	47.0 (30.5–67.0)	54.0 (23.0–68.0)	61.0 (42.0–74.0)	51.0 (28.0–70.0)
Missing, n	5	4	3	12
36 weeks				
Median, mm (IQR)	40.0 (21.0–60.0)	38.0 (19.0–72.0)	56.0 (41.0–63.0)	48.5 (24.0–63.0)
Missing, n	7	7	6	20
48 weeks				
Median, mm (IQR)	49.0 (22.0–66.0)	51.5 (19.0–72.0)	57.0 (34.0–67.0)	51.0 (22.0–68.0)
Missing, n	10	7	10	27
60 weeks				
Median, mm (IQR)	64.0 (32.0–71.0)	48.5 (15.5–63.5)	47.0 (27.0–83.0)	58.0 (27.0–71.0)
Missing, n	27	25	29	81
72 weeks				
Median, mm (IQR)	42.0 (12.5–53.0)	56.0 (31.0–87.0)	52.0 (24.0–85.0)	45.0 (26.0–62.5)
Missing, n	33	28	33	94
84 weeks				
Median, mm (IQR)	57.0 (16.0–71.0)	41.0 (14.0–66.0)	67.0 (29.0–85.0)	57.0 (16.0–71.0)
Missing, n	34	32	34	100
96 weeks				
Median, mm (IQR)	30.0 (7.0–36.0)	30.5 (3.0–60.0)	36.0 (31.0–89.0)	33.5 (7.0–53.0)
Missing, n	36	37	37	110
<b>Patient Global Assessment of Arthritis VAS</b>				
Baseline				
Median, mm (IQR)	70.5 (62.0–83.0)	67.5 (52.0–79.5)	74.0 (53.0–85.0)	71.0 (56.0–83.0)
Missing, n	1	1	3	5
12 weeks				
Median, mm (IQR)	51.5 (32.0–71.0)	43.0 (27.0–60.0)	49.0 (42.0–78.0)	48.0 (30.0–69.0)
Missing, n	5	2	1	8

continued

TABLE 67 Patient global assessment of pain, arthritis and general health over time (continued)

Visit	Treatment arm			Total (n = 122)
	Alternative TNFi (n = 41)	Abatacept (n = 41)	Rituximab (n = 40)	
24 weeks				
Median, mm (IQR)	45.5 (26.5–68.0)	48.0 (20.0–66.0)	52.0 (39.0–70.0)	48.0 (31.0–69.0)
Missing, n	5	4	3	12
36 weeks				
Median, mm (IQR)	41.5 (21.0–60.0)	49.0 (27.1–71.0)	51.5 (39.0–62.0)	49.0 (28.0–66.0)
Missing, n	7	7	6	20
48 weeks				
Median, mm (IQR)	47.0 (22.0–69.0)	55.5 (25.0–68.0)	55.0 (35.0–70.0)	53.0 (26.0–69.0)
Missing, n	10	7	10	27
60 weeks				
Median, mm (IQR)	60.0 (21.0–69.0)	44.0 (21.0–71.5)	66.0 (27.0–77.0)	54.0 (24.0–70.0)
Missing, n	27	25	29	81
72 weeks				
Median, mm (IQR)	40.0 (18.0–54.5)	48.0 (38.0–77.0)	56.5 (19.5–64.5)	47.0 (29.0–65.0)
Missing, n	33	28	32	93
84 weeks				
Median, mm (IQR)	51.0 (18.0–64.0)	56.0 (24.0–63.0)	53.0 (24.0–85.0)	53.5 (24.0–72.0)
Missing, n	34	32	34	100
96 weeks				
Median, mm (IQR)	25.0 (11.0–35.0)	32.5 (6.0–57.5)	43.0 (24.0–81.0)	30.0 (10.5–54.5)
Missing, n	36	37	37	110
<b>Patient Global Health Assessment of General Health</b>				
Baseline				
Median, mm (IQR)	56.5 (45.5–72.0)	62.0 (47.8–68.5)	61.0 (46.0–74.0)	59.0 (47.0–70.0)
Missing, n	1	1	3	5
12 weeks				
Median, mm (IQR)	46.5 (25.5–64.5)	46.0 (23.0–60.0)	53.0 (34.0–70.0)	50.0 (28.0–64.0)
Missing, n	5	2	1	8
24 weeks				
Median, mm (IQR)	46.0 (32.5–63.0)	48.0 (24.0–68.0)	42.0 (27.0–65.0)	47.0 (27.0–64.0)
Missing, n	5	4	3	12
36 weeks				
Median, mm (IQR)	38.5 (19.0–55.0)	55.0 (30.0–70.0)	49.0 (40.0–58.0)	48.0 (29.0–60.0)
Missing	7	7	7	21

**TABLE 67** Patient global assessment of pain, arthritis and general health over time (*continued*)

Visit	Treatment arm			Total (n = 122)
	Alternative TNFi (n = 41)	Abatacept (n = 41)	Rituximab (n = 40)	
48 weeks				
Median, mm (IQR)	48.0 (26.0–63.0)	49.0 (27.0–67.0)	52.0 (31.0–64.0)	50.0 (28.0–63.0)
Missing, n	11	7	10	28
60 weeks				
Median, mm (IQR)	54.5 (24.0–61.0)	43.0 (22.0–55.0)	46.0 (24.0–65.0)	47.5 (24.0–61.0)
Missing, n	27	24	29	80
72 weeks				
Median, mm (IQR)	43.5 (21.5–56.0)	50.0 (33.0–75.0)	50.0 (25.0–72.0)	48.5 (27.5–69.5)
Missing, n	33	28	33	94
84 weeks				
Median, mm (IQR)	46.0 (18.0–60.0)	46.0 (31.0–55.0)	74.5 (66.0–82.0)	49.5 (31.0–71.0)
Missing, n	34	32	34	100
96 weeks				
Median, mm (IQR)	24.0 (20.0–37.0)	20.5 (10.0–31.0)	43.0 (20.0–89.0)	22.5 (20.0–42.0)
Missing, n	36	37	37	110

IQR, interquartile range.

**Note**

Higher scores correspond to worse pain, poor disease activity and poor general health.

TABLE 68 Bone densitometry at baseline and 48 weeks

Bone densitometry parameter	Treatment arm			Total (n = 55)
	Alternative TNFi (n = 17)	Abatacept (n = 20)	Rituximab (n = 18)	
<b>Baseline</b>				
Bone densitometry scan been performed, n (%)				
Yes	11 (64.7)	12 (60.0)	10 (55.6)	33 (60.0)
No	6 (35.3)	8 (40.0)	8 (44.4)	22 (40.0)
Neck of femur densitometry				
Median <i>t</i> -score (IQR)	-0.8 (-1.6 to -0.2)	-0.5 (-0.8 to 0.2)	-1.0 (-1.3 to 0.3)	-0.7 (-1.3 to 0.1)
Missing, <i>n</i>	6	9	8	23
Neck of femur densitometry				
Median <i>z</i> -score (IQR)	-0.6 (-0.8 to 0.4)	0.4 (0.0 to 1.1)	0.4 (-0.7 to 0.7)	0.4 (-0.7 to 0.8)
Missing, <i>n</i>	7	9	8	24
Spine densitometry				
Median <i>t</i> -score (IQR)	-0.2 (-1.9 to 1.2)	0.4 (-0.8 to 1.1)	-1.3 (-1.8 to 0.5)	-0.3 (-1.3 to 1.1)
Missing, <i>n</i>	6	9	8	23
Spine densitometry				
Median <i>z</i> -score (IQR)	0.2 (-0.4 to 1.2)	1.6 (0.6 to 2.7)	0.3 (-0.2 to 1.5)	0.6 (-0.1 to 2.1)
Missing, <i>n</i>	7	9	8	24
<b>Week 48</b>				
Bone densitometry scan been performed, n (%)				
Yes	6 (35.3)	5 (25.0)	3 (16.7)	14 (25.5)
No	11 (64.7)	15 (75.0)	15 (83.3)	41 (74.5)
Neck of femur densitometry				
Median <i>t</i> -score (IQR)	-0.8 (-2.1 to 0.4)	-0.7 (-0.8 to -0.7)	-0.3 (-2.0 to 1.5)	-0.7 (-1.1 to -0.3)
Missing, <i>n</i>	11	15	15	41
Neck of femur densitometry				
Median <i>z</i> -score (IQR)	-0.7 (-1.6 to -0.7)	0.7 (0.0 to 0.9)	0.1 (-1.2 to 0.6)	-0.1 (-0.7 to 0.6)
Missing, <i>n</i>	12	15	15	42
Spine densitometry				
Median <i>t</i> -score (IQR)	-1.2 (-1.9 to -0.1)	0.5 (-2.2 to 2.4)	-0.9 (-2.2 to -0.3)	-0.9 (-1.9 to -0.1)
Missing, <i>n</i>	11	16	15	42
Spine densitometry				
Median <i>z</i> -score (IQR)	-0.7 (-1.2 to 0.0)	1.8 (0.5 to 4.1)	0.0 (-1.3 to 0.7)	0.0 (-1.0 to 0.7)
Missing, <i>n</i>	11	16	15	42

IQR, interquartile range.

## Appendix 13 Data missingness

**TABLE 69** Summary of component-level missingness for DAS28 and ACR response at all time points to week 48

Component (visit)	Treatment arm					
	Alternative TNFi		Abatacept		Rituximab	
	<i>n</i>	%	<i>n</i>	%	<i>n</i>	%
CRP level						
Baseline	1	2.4	2	4.9	1	2.5
12 weeks	9	22.0	3	7.3	1	2.5
24 weeks	6	14.6	3	7.3	1	2.5
36 weeks	9	22.0	7	17.1	5	12.5
48 weeks	10	24.4	8	19.5	9	22.5
ESR						
Baseline	0	0.0	2	4.9	2	5.0
12 weeks	5	12.2	4	9.8	1	2.5
24 weeks	4	9.8	3	7.3	1	2.5
36 weeks	7	17.1	8	19.5	8	20.0
48 weeks	11	26.8	7	17.1	10	25.0
HAQ-DI						
Baseline	1	2.4	1	2.4	1	2.5
12 weeks	4	9.8	2	4.9	0	0.0
24 weeks	5	12.2	4	9.8	2	5.0
36 weeks	7	17.1	7	17.1	6	15.0
48 weeks	11	26.8	7	17.1	10	25.0
Patient Global Assessment of Arthritis VAS						
Baseline	1	2.4	1	2.4	3	7.5
12 weeks	5	12.2	2	4.9	1	2.5
24 weeks	5	12.2	4	9.8	3	7.5
36 weeks	7	17.1	7	17.1	6	15.0
48 weeks	10	24.4	7	17.1	10	25.0
Patient Global Assessment of Pain VAS						
Baseline	1	2.4	1	2.4	3	7.5
12 weeks	5	12.2	2	4.9	1	2.5
24 weeks	5	12.2	4	9.8	3	7.5
36 weeks	7	17.1	7	17.1	6	15.0
48 weeks	10	24.4	7	17.1	10	25.0

continued

**TABLE 69** Summary of component-level missingness for DAS28 and ACR response at all time points to week 48 (*continued*)

Component (visit)	Treatment arm					
	Alternative TNFi		Abatacept		Rituximab	
	<i>n</i>	%	<i>n</i>	%	<i>n</i>	%
Physician Global Assessment of Disease Activity VAS						
Baseline	0	0.0	2	4.9	1	2.5
12 weeks	5	12.2	2	4.9	1	2.5
24 weeks	5	12.2	4	9.8	3	7.5
36 weeks	8	19.5	8	19.5	5	12.5
48 weeks	10	24.4	8	19.5	10	25.0
SJC						
Baseline	0	0.0	0	0.0	1	2.5
12 weeks	4	9.8	2	4.9	0	0.0
24 weeks	4	9.8	3	7.3	1	2.5
36 weeks	7	17.1	7	17.1	5	12.5
48 weeks	10	24.4	8	19.5	10	25.0
TJC						
Baseline	0	0.0	0	0.0	1	2.5
12 weeks	4	9.8	2	4.9	0	0.0
24 weeks	4	9.8	3	7.3	1	2.5
36 weeks	7	17.1	7	17.1	5	12.5
48 weeks	10	24.4	8	19.5	10	25.0

**Note**

Frequency of patients with at least one component missing over the follow-up duration and the summary statistics of the numbers of missing components for each patient.

**TABLE 70** Summary of patient-level missingness for DAS28 components to week 48 and ACR response components to week 24 and 48

Patient-level missingness	Treatment arm			
	Alternative TNFi ( <i>n</i> = 41)	Abatacept ( <i>n</i> = 41)	Rituximab ( <i>n</i> = 40)	Total ( <i>n</i> = 122)
Missing DAS28 components (up to week 48 per patient)				
Mean, <i>n</i> (SD)	2.6 (4.94)	2.1 (3.78)	2.0 (2.98)	2.2 (3.97)
Median, <i>n</i> (IQR)	0.0 (0.0–4.0)	0.0 (0.0–4.0)	0.0 (0.0–3.5)	0.0 (0.0–4.0)
Range	0.0–17.0	0.0–16.0	0.0–12.0	0.0–17.0
Missing, <i>n</i>	0	0	0	0
All DAS28 components completed over 48 weeks, <i>n</i> (%)				
All completed	26 (63.4)	24 (58.5)	21 (52.5)	71 (58.2)
One or more incomplete	15 (36.6)	17 (41.5)	19 (47.5)	51 (41.8)
Missing ACR response components (up to week 48 per patient)				
Mean, <i>n</i> (SD)	5.5 (9.85)	4.2 (7.53)	4.0 (6.00)	4.6 (7.93)
Median, <i>n</i> (IQR)	1.0 (0.0–8.0)	1.0 (0.0–8.0)	1.0 (0.0–8.0)	1.0 (0.0–8.0)
Range	0.0–35.0	0.0–32.0	0.0–23.0	0.0–35.0
Missing, <i>n</i>	0	0	0	0
All ACR response components completed over 48 weeks, <i>n</i> (%)				
All completed	19 (46.3)	19 (46.3)	19 (47.5)	57 (46.7)
One or more incomplete	22 (53.7)	22 (53.7)	21 (52.5)	65 (53.3)
Missing ACR response components (up to week 24 per patient)				
Mean, <i>n</i> (SD)	2.0 (4.85)	1.4 (3.66)	0.8 (1.74)	1.4 (3.66)
Median, <i>n</i> (IQR)	0.0 (0.0–1.0)	0.0 (0.0–1.0)	0.0 (0.0–1.0)	0.0 (0.0–1.0)
Range	0.0–19.0	0.0–16.0	0.0–7.0	0.0–19.0
Missing, <i>n</i>	0	0	0	0
All ACR response components completed over 24 weeks, <i>n</i> (%)				
All completed	27 (65.9)	29 (70.7)	29 (72.5)	85 (69.7)
One or more incomplete	14 (34.1)	12 (29.3)	11 (27.5)	37 (30.3)

IQR, interquartile range.





## Appendix 14 Safety line listings

TABLE 71 Line listing of all serious ARs

Treatment Randomised	Medical Dictionary for Regulatory Activities' Organ Class	SAE code	SAE in medical terms	SAE description	Age (years)	Sex	Seriousness criteria	Causality	Suspected to be related to	Expectedness	Date of registration	Randomisation date	Date event became serious
Alternative TNFi	Hepatobiliary disorders	N00072/00024/001	Autoimmune Hepatitis	Persistently raised/rising liver enzyme levels despite cessation of MTX co-therapy	34	Female	3	Trial medications	Infliximab	Expected	7 August 2013	4 September 2013	27 April 2014
Abatacept	Skin and subcutaneous tissue disorders	N00400/00074/001	Angiooedema	Participant woke up feeling unwell after first injection of abatacept, husband confirmed she had signs of angiooedema (swollen tongue, swollen face) and swollen hands. No rash, pruritus, no other symptoms/signs reported. It is unclear if breathing was somehow compromised but if affirmative likely not to be severe, as patient took co-codamol and went to bed again. The principal investigator has informed patient of the potential seriousness of symptoms and strongly advised to seek medical attention if happens again	43	Female	6	Trial medications	Abatacept	Expected	4 March 2014	4 March 2014	10 April 2014
Abatacept	Infections and infestations	N02220/00077/001	Pneumonia	Pneumonia leading to sepsis. Stroke – left middle cerebral artery	81	Female	1–3	Trial medications, 998 to 999 (COPD, smoking history)	Abatacept	Expected	12 March 2014	31 March 2014	10 October 2014

COPD, chronic obstructive pulmonary disorder.

TABLE 72 Line listing of all serious ARs

Treatment Randomised	Medical Dictionary for Regulatory Activities' System Organ Class	SAE code	SAE in medical terms	Recovery date	Duration (days)	Outcome	First ever trial medication	Product form	First trial dose	Date most recent dose	Most recent dosing schedule	Most recent route
Alternative TNFi	Hepatobiliary disorders	N00072/00024/001	Autoimmune hepatitis	30 September 2014	157	Recovered with sequelae	Infliximab	Intravenous	10 September 2013	10 February 2014	261 mg	Intravenous
Abatacept	Skin and subcutaneous tissue disorders	N00400/00074/001	Angiooedema	11 April 2014	2	Recovered	Abatacept	Subcutaneous injection	9 April 2014	8 July 2014	125 mg, weekly	Subcutaneous
Abatacept	Infections and infestations	N02220/00077/001	Pneumonia			Death	Abatacept	Subcutaneous injection	31 March 2014			

TABLE 73 Line listing of all SAEs (not related to IMP)

Treatment Randomised	Medical Dictionary for Regulatory Activities' System Organ Class	SAE code	SAE in medical terms	SAE description	Age	Sex	Seriousness criteria	Causality	Date of registration	Randomisation date	Date event became serious	Recovery date
Abatacept		N00168/00146/001	Chest pain/epigastric pain	Constant epigastric/chest pain for past 2 weeks. Increasingly worse. Prior admission to King's Mill Hospital and discharged with no diagnosis. Today (5 February 2015) seen in the accident and emergency department at Royal Derby Hospital and admitted for surgical assessment. Patient was admitted to hospital for a third occasion on 22 February 2015 for the same medical condition. 24 hours stay. Nothing abnormal detected. Investigations continue	36	Female	3		10 November 2014	11 November 2014	25 January 2015	

continued

**TABLE 73** Line listing of all SAEs (not related to IMP) (*continued*)

Treatment Randomised	Medical Dictionary for Regulatory Activities <sup>1</sup> System Organ Class	SAE code	SAE in medical terms	SAE description	Age	Sex	Seriousness criteria	Causality	Date of registration	Randomisation date	Date event became serious	Recovery date
Abatacept	Infections and infestations	N00178/00134/001	Chest Infection	Persistent cough, chest infection	81	Female	3	999 (contact with family with viral chest infection)	24 September 2014	9 October 2014	11 December 2014	29 December 2014
Rituximab	Neoplasms benign, malignant and unspecified (including cysts and polyps)	N00071/00037/001	Malignant melanoma	Presented to the accident and emergency department with fungating and partially necrotic mass posteromedial knee. Magnetic resonance imaging highly suggestive of sarcoma. Referred to Freeman Hospital. Biopsies confirm melanoma with positive groin nodes. Referred for surgery	66	Male	1–3	999 [Humira (previous medication)]	4 October 2013	14 October 2013	27 February 2014	
Rituximab	Musculoskeletal and connective tissue disorders	N00473/00045/001	Flare of RA	Admitted via the accident and emergency department with 'flare of RA' suspected to have underlying chest infection. CRP level > 100. Secondary to left basal pneumonia. Signs/symptoms = generalised joint pain. Admitted 24 January 2014. Discharged 29 January 2014	58	Male	3	998 (pneumonia)	5 November 2013	13 November 2013	24 January 2014	29 January 2014
Rituximab	Respiratory, thoracic and mediastinal disorders	N00473/00045/002	Left basal pneumonia	Flu-like symptoms, pyrexia, pleuritic chest pain and productive cough. Admitted 24 January 2014. Discharged 29 January 2014	58	Male	3	999 (community acquired)	5 November 2013	13 November 2013	24 January 2014	10 February 2014
Rituximab	Musculoskeletal and connective tissue disorders	N00473/00114/001	Collapse and broken coccyx	As a result of collapse in the bathroom the patient sustained a broken coccyx	75	Female	3	998 (suspected neurological condition)	25 July 2014	7 August 2014	22 January 2015	27 January 2015
Rituximab	Gastrointestinal disorders	N00482/00008/001	Abdominal pain	Vomiting and two episodes of diarrhoea	53	Female	3	999 (scarring from hysterectomy)	8 January 2013	22 January 2013	7 May 2013	8 May 2013

**TABLE 74** Line listing of all SAEs (not related to IMP)

Treatment Randomised	Medical Dictionary for Regulatory Activities' System Organ Class	SAE code	SAE in medical terms	Duration (days)	Outcome	First ever trial medication	Product form	First trial dose	Date most recent dose	Most recent dosing schedule	Most recent route
Abatacept		N00168/00146/001	Chest pain/epigastric pain		Condition still present and unchanged	Abatacept	Subcutaneous injection	14 November 2014	4 February 2015	125 mg weekly	Subcutaneous
Abatacept	Infections and infestations	N00178/00134/001	Chest infection	19	Recovered	Abatacept	Subcutaneous injection	9 October 2014	27 November 2014	125 mg weekly	Subcutaneous
Rituximab	Neoplasms benign, malignant and unspecified (including cysts and polyps)	N00071/00037/001	Malignant melanoma		Death	Rituximab	Intravenous	23 October 2013	6 November 2013	1 g	Intravenous
Rituximab	Musculoskeletal and connective tissue disorders	N00473/00045/001	Flare of RA	6	Recovered			<sup>a</sup>		...	
Rituximab	Respiratory, thoracic and mediastinal disorders	N00473/00045/002	Left basal pneumonia	18	Recovered			<sup>a</sup>		...	
Rituximab	Musculoskeletal and connective tissue disorders	N00473/00114/001	Collapse and broken coccyx	6	Recovered with sequelae	Rituximab	Intravenous	4 September 2014	24 September 2014	1 g	Intravenous
Rituximab	Gastrointestinal disorders	N00482/00008/001	Abdominal pain	2	Recovered	Rituximab	Intravenous	24 January 2013	7 February 2013	1 g	Intravenous

<sup>a</sup> Patient 00045 had not received first infusion by the time of SAE onset because of a prolonged delay to the start of treatment. Hence, no treatment had been received.

TABLE 75 Line listing of non-SAEs

Treatment randomised	Centre name and number	Patient number	First reported	AE description	New or pre-existing event?	Intensity	Causality	Expectedness	(For infections) Requested treatment with antibiotics?	SAE or SUSAR?	Stopping of treatment
Adalimumab	Northampton General Hospital; N00038	00119	Week 12	URTI (sore throat, runny nose)	New	Moderate	Unrelated	Unexpected	No	No	No
Adalimumab	Northampton General Hospital; N00038	00119	Week 12	Non-cardiac chest pain	New	Moderate	Unrelated	Unexpected	N/A	No	No
Adalimumab	Manchester Royal Infirmary; N00080	00023	Week 12	Worsening RA	New	Moderate	Probably	Unexpected	N/A	No	Permanent
Adalimumab	Cannock Chase Hospital; N00473	00028	Week 48	Nausea	Pre-existing	Mild	Unrelated	Unexpected	No	No	No
Adalimumab	Chapel Allerton Hospital, Leeds; N00482	00032	Week 12	LRTI, lower respiring chest infection	New	Moderate	Possibly	Expected	Yes	No	Temporary
Adalimumab	Chapel Allerton Hospital, Leeds; N00482	00032	Week 12	Exacerbation of COPD	New	Moderate	Possibly	Expected	No	No	Temporary
Adalimumab	Chapel Allerton Hospital, Leeds; N00482	00032	Week 24	Benign cyst on right breast	New	Mild	Unlikely	Unexpected	No	No	No
Adalimumab	Chapel Allerton Hospital, Leeds; N00482	00032	Week 24	Cold symptoms	New	Mild	Probably	Expected	Yes	No	Temporary
Adalimumab	Chapel Allerton Hospital, Leeds; N00482	00032	Week 36	Infective exacerbation of COPD	Pre-existing	Moderate	Unrelated	Unexpected	Yes	No	Temporary
Adalimumab	Chapel Allerton Hospital, Leeds; N00482	00032	Week 48	Exacerbation of COPD	Pre-existing	Severe	Possibly	Expected	Yes	No	Temporary
Adalimumab	Broadgreen Hospital, Liverpool; N00589	00110	Week 12	Rash – maculopapular grade 1	New	Moderate	Possibly	Unexpected	N/A	No	No

Treatment randomised	Centre name and number	Patient number	First reported	AE description	New or pre-existing event?	Intensity	Causality	Expectedness	(For infections) Requested treatment with antibiotics?	SAE or SUSAR?	Stopping of treatment
CZP	Birmingham City Hospital; N00346	00086	Week 12	Vomiting	New	Moderate	Unlikely	Unexpected	No	No	Temporary
Golimumab	Airedale General Hospital; N00074	00088	Week 36	Chest infection	New	Moderate	Probably	Expected	Yes	No	Temporary
Golimumab	Airedale General Hospital; N00074	00088	Week 48	Fatigue	New	Mild	Unrelated	Unexpected	N/A	No	No
Golimumab	Airedale General Hospital; N00074	00088	Week 48	Mouth ulcers	New	Moderate	Unrelated	Unexpected	N/A	No	No
Golimumab	Airedale General Hospital; N00074	00088	Week 48	Poor sleep	New	Mild	Unrelated	Unexpected	N/A	No	No
Golimumab	Derriford Hospital, Plymouth; N00118	00133	Week 24	Abnormal liver blood test	New	Moderate	Possibly	Unexpected	No	No	No
Golimumab	Derriford Hospital, Plymouth; N00118	00133	Week 24	One episode of heart rate rise to 146 b.p.m + feeling faint	New	Mild	Possibly	Unexpected	No	No	No
Golimumab	Derriford Hospital, Plymouth; N00118	00133	Week 36	Nasal sores crusts	New	Moderate	Possibly	Unexpected	Yes	No	Temporary
Golimumab	Derriford Hospital, Plymouth; N00118	00133	Week 36	Reduced liver function blood results stopped MTX temporarily	New	Moderate	Almost certainly	Unexpected	N/A	No	Temporary
Golimumab	Derriford Hospital, Plymouth; N00118	00133	Week 48	Chest infection	New	Mild	Possibly	Unexpected	No	No	No
Golimumab	Derriford Hospital, Plymouth; N00118	00133	Week 48	Sore throat and earache	New	Mild	Unlikely	Unexpected	No	No	No
Golimumab	Derriford Hospital, Plymouth; N00118	00133	Week 48	Nasal crusts/ulcers	New	Mild	Probably	Unexpected	No	No	No
Golimumab	Derriford Hospital, Plymouth; N00118	00133	Week 48	Styes both eyes	New	Mild	Unlikely	Unexpected	No	No	No

continued

TABLE 75 Line listing of non-SAEs (continued)

Treatment randomised	Centre name and number	Patient number	First reported	AE description	New or pre-existing event?	Intensity	Causality	Expectedness	(For infections) Requested treatment with antibiotics?	SAE or SUSAR?	Stopping of treatment
Infliximab	Royal Victoria Infirmary, Newcastle; N00072	00024	Week 12	Sore throat	New	Mild	Possibly	Expected	No	No	No
Infliximab	Royal Victoria Infirmary, Newcastle; N00072	00024	Week 24	Elevated ALT levels in blood samples taken on 10 February 2014	New	Moderate	Possibly	Expected	N/A	No	Permanent
Etanercept	Leicester Royal Infirmary; N00031	00094	Week 24	Viral infection	New	Moderate	Possibly	Unexpected	Yes	No	Temporary
Etanercept	Leicester Royal Infirmary; N00031	00094	Week 24	Haemoglobin decreased	New	Mild	Unlikely	Unexpected	No	No	No
Etanercept	Leicester Royal Infirmary; N00031	00094	Week 24	Abdominal pain	New	Mild	Unlikely	Unexpected	No	No	No
Etanercept	Leicester Royal Infirmary; N00031	00094	Week 24	↑ left wrist pain	Pre-existing	Mild	Unlikely	Expected	No	No	No
Etanercept	Northampton General Hospital; N00038	00112	Week 24	Chest infection	New	Moderate	Possibly	Unexpected	Yes	No	Temporary
Etanercept	Queen Elizabeth Hospital, Gateshead; N00071	00096	Week 12	Reaction around injection site	New	Moderate	Almost certainly	Expected	No	No	Permanent
Etanercept	Airedale General Hospital; N00074	00147	Week 12	Nausea	New	Moderate	Unrelated	Expected	N/A	No	Temporary
Etanercept	Derriford Hospital, Plymouth; N00118	00060	Week 12	Nausea	New	Moderate	Probably	Expected	N/A	No	No
Etanercept	Derriford Hospital, Plymouth; N00118	00060	Week 36	Pain in both feet	New	Moderate	Unlikely	Unexpected	N/A	No	No
Etanercept	Derriford Hospital, Plymouth; N00118	00060	Week 36	Pimples on neck	New	Mild	Unlikely	Unexpected	N/A	No	No
Etanercept	King George Hospital, Ilford; N00165	00046	Week 12	UTI requiring oral antibiotics	New	Moderate	Possibly	Expected	Yes	No	Temporary



Treatment randomised	Centre name and number	Patient number	First reported	AE description	New or pre-existing event?	Intensity	Causality	Expectedness	(For infections) Requested treatment with antibiotics?	SAE or SUSAR?	Stopping of treatment
Etanercept	King George Hospital, Ilford; N00165	00046	Week 12	Erythematous lesion at Enbrel injection site	New	Moderate	Almost certainly	Expected	N/A	No	Temporary
Etanercept	King George Hospital, Ilford; N00165	00046	Week 24	Pain with swelling in the tummy area where injection was given	New	Mild	Almost certainly	Expected	N/A	No	No
Etanercept	King George Hospital, Ilford; N00165	00057	Week 12	UTI	New	Moderate	Possibly	Expected	Yes	No	Temporary
Etanercept	King George Hospital, Ilford; N00165	00057	Week 12	Twisted (right) knee	New	Mild	Unrelated	Unexpected	N/A	No	No
Etanercept	King George Hospital, Ilford; N00165	00057	Week 24	Upper molar extraction abscess	New	Moderate	Possibly	Unexpected	Yes	No	Temporary
Etanercept	Queen's Hospital, Burton upon Trent; N00178	00073	Week 12	Itching erythema	New	Mild	Almost certainly	Expected	No	No	No
Etanercept	Queen's Hospital, Burton upon Trent; N00178	00073	Week 48	Right haemorrhagic branch retinal vein occlusion (retinal vascular disorder CTCAE description)	New	Moderate	Unrelated	Unexpected	No	No	No
Etanercept	Queen's Hospital, Burton upon Trent; N00178	00121	Week 12	Tonsillitis	New	Moderate	Unrelated	Expected	Yes	No	Temporary
Etanercept	Queen's Hospital, Burton upon Trent; N00178	00121	Week 12	Injection site reaction	New	Moderate	Almost certainly	Expected	No	No	No
Etanercept	Queen's Hospital, Burton upon Trent; N00178	00121	Week 12	Subconjunctival haemorrhage	New	Mild	Unrelated	Expected	No	No	No

continued

TABLE 75 Line listing of non-SAEs (continued)

Treatment randomised	Centre name and number	Patient number	First reported	AE description	New or pre-existing event?	Intensity	Causality	Expectedness	(For infections) Requested treatment with antibiotics?	SAE or SUSAR?	Stopping of treatment
Etanercept	Guy's Hospital, London; N00241	00064	Week 12	Migraine	New	Moderate	Unrelated	Expected	N/A	No	No
Etanercept	Guy's Hospital, London; N00241	00064	Week 24	Migraine	Pre-existing	Mild	Unrelated	Expected	No	No	No
Etanercept	Guy's Hospital, London; N00241	00064	Week 36	Migraine	Pre-existing	Moderate	Unrelated	Expected	N/A	No	No
Etanercept	Guy's Hospital, London; N00241	00064	Week 48	Right flank abdominal pain	New	Mild	Unrelated	Unexpected	N/A	No	No
Etanercept	Salford Royal Infirmary; N00400	00084	Week 12	URTI	New	Mild	Unrelated	Unexpected	No	No	No
Etanercept	Salford Royal Infirmary; N00400	00084	Week 24	Mouth ulcers	New	Moderate	Unlikely	Unexpected	No	No	No
Etanercept	Salford Royal Infirmary; N00400	00084	Week 24	Toothache	New	Moderate	Unlikely	Unexpected	No	No	No
Etanercept	Salford Royal Infirmary; N00400	00084	Week 36	Rash left hand	New	Moderate	Unlikely	Unexpected	N/A	No	No
Etanercept	Salford Royal Infirmary; N00400	00084	Week 48	Hay fever	New	Mild	Unrelated	Unexpected	N/A	No	No
Etanercept	Cannock Chase Hospital; N00473	00041	Week 12	Injection site reaction	New	Moderate	Almost certainly	Unexpected	N/A	No	No
Etanercept	Cannock Chase Hospital; N00473	00041	Week 24	Sickness	New	Mild	Unlikely	Unexpected	No	No	No
Etanercept	Cannock Chase Hospital; N00473	00041	Week 24	Diarrhoea	New	Mild	Unlikely	Unexpected	No	No	No
Etanercept	Cannock Chase Hospital; N00473	00041	Week 24	Throat infection	New	Mild	Unlikely	Unexpected	Yes	No	Temporary
Etanercept	Cannock Chase Hospital; N00473	00041	Week 24	Eye infection	New	Mild	Unlikely	Unexpected	Yes	No	No
Etanercept	Cannock Chase Hospital; N00473	00041	Week 36	Vaginal thrush	New	Mild	Unlikely	Unexpected	No	No	No

Treatment randomised	Centre name and number	Patient number	First reported	AE description	New or pre-existing event?	Intensity	Causality	Expectedness	(For infections) Requested treatment with antibiotics?	SAE or SUSAR?	Stopping of treatment
Etanercept	Cannock Chase Hospital; N00473	00041	Week 36	Sinusitis	New	Mild	Unlikely	Unexpected	Yes	No	No
Etanercept	Cannock Chase Hospital; N00473	00041	Week 48	Sinusitis	Pre-existing	Mild	Unlikely	Unexpected	No	No	No
Etanercept	Chapel Allerton Hospital, Leeds; N00482	00001	Week 12	(Left) lower backache	New	Mild	Unrelated	Unexpected	N/A	No	No
Etanercept	Chapel Allerton Hospital, Leeds; N00482	00004	Week 12	Injection site reaction	New	Mild	Almost certainly	Expected	No	No	No
Etanercept	Chapel Allerton Hospital, Leeds; N00482	00004	Week 48	Facial rash and chest rash, non-blanching	New	Moderate	Possibly	Expected	No	No	No
Etanercept	Chapel Allerton Hospital, Leeds; N00482	00018	Week 12	Bruising	New	Mild	Possibly	Unexpected	N/A	No	No
Etanercept	Chapel Allerton Hospital, Leeds; N00482	00018	Week 12	Chest infection	New	Moderate	Unlikely	Unexpected	Yes	No	Temporary
Etanercept	Chapel Allerton Hospital, Leeds; N00482	00018	Week 12	Nausea	New	Mild	Possibly	Unexpected	N/A	No	No
Etanercept	Chapel Allerton Hospital, Leeds; N00482	00018	Week 24	Sickness with (nausea) etanercept	New	Moderate	Almost certainly	Expected	N/A	No	Permanent
Etanercept	Chapel Allerton Hospital, Leeds; N00482	00018	Week 24	Bruising	New	Mild	Possibly	Unexpected	N/A	No	Permanent
Etanercept	Chapel Allerton Hospital, Leeds; N00482	00018	Week 24	Chest infection	New	Moderate	Probably	Expected	Yes	No	No

continued

TABLE 75 Line listing of non-SAEs (continued)

Treatment randomised	Centre name and number	Patient number	First reported	AE description	New or pre-existing event?	Intensity	Causality	Expectedness	(For infections) Requested treatment with antibiotics?	SAE or SUSAR?	Stopping of treatment
Etanercept	Chapel Allerton Hospital, Leeds; N00482	00018	Week 48	Cut (right) shin	New	Mild	Unrelated	Unexpected	N/A	No	No
Etanercept	Chapel Allerton Hospital, Leeds; N00482	00059	Week 48	Cold	New	Mild	Probably	Expected	No	No	No
Etanercept	Chapel Allerton Hospital, Leeds; N00482	00065	Week 48	Cellulitis	New	Moderate	Probably	Unexpected	Yes	No	Temporary
Etanercept	Chapel Allerton Hospital, Leeds; N00482	00070	Week 48	Diarrhoea	New	Mild	Missing	Unexpected	No	No	No
Etanercept	Chapel Allerton Hospital, Leeds; N00482	00070	Week 48	Cold	New	Mild	Missing	Expected	No	No	No
Etanercept	Chapel Allerton Hospital, Leeds; N00482	00070	Week 48	Fall	New	Moderate	Missing	Unexpected	No	No	No
Etanercept	Chapel Allerton Hospital, Leeds; N00482	00070	Week 48	Tooth infection	New	Moderate	Missing	Expected	Yes	No	No
Etanercept	Royal National Hospital for Rheumatic Diseases, Bath; N02220	00044	Week 12	Swelling of ankles in the evening	New	Mild	Possibly	Unexpected	N/A	No	No
Etanercept	Royal National Hospital for Rheumatic Diseases, Bath; N02220	00044	Week 12	Blocked nose (on SmPC)	New	Mild	Probably	Unexpected	N/A	No	No
Etanercept	Royal National Hospital for Rheumatic Diseases, Bath; N02220	00044	Week 12	Right shoulder/neck pain	New	Mild	Unrelated	Unexpected	N/A	No	No

Treatment randomised	Centre name and number	Patient number	First reported	AE description	New or pre-existing event?	Intensity	Causality	Expectedness	(For infections) Requested treatment with antibiotics?	SAE or SUSAR?	Stopping of treatment
Abatacept	Leicester Royal Infirmary; N00031	00087	Week 24	Mouth ulcer	Pre-existing	Moderate	Possibly	Unexpected	No	No	No
Abatacept	Leicester Royal Infirmary; N00031	00087	Week 36	Nose bleeds	Pre-existing	Mild	Unrelated	Unexpected	N/A	No	No
Abatacept	Leicester Royal Infirmary; N00031	00087	Week 36	Dizziness	Pre-existing	Mild	Unrelated	Unexpected	N/A	No	No
Abatacept	Leicester Royal Infirmary; N00031	00087	Week 36	Swollen ankles	Pre-existing	Moderate	Unrelated	Expected	N/A	No	No
Abatacept	Leicester Royal Infirmary; N00031	00087	Week 36	Slurring	Pre-existing	Mild	Unrelated	Unexpected	N/A	No	No
Abatacept	Leicester Royal Infirmary; N00031	00087	Week 36	Sore mouth	Pre-existing	Mild	Unrelated	Unexpected	N/A	No	No
Abatacept	Darlington Memorial Hospital; N00068	00097	Week 12	Feeling generally a bit low and lethargic	New	Mild	Unlikely	Expected	No	No	No
Abatacept	Darlington Memorial Hospital; N00068	00097	Week 12	Cool hands and feet	New	Mild	Possibly	Expected	No	No	No
Abatacept	Darlington Memorial Hospital; N00068	00097	Week 12	↓ haemoglobin levels	New	Moderate	Unlikely	Unexpected	No	No	No
Abatacept	Darlington Memorial Hospital; N00068	00097	Week 24	Flare of RA	New	Moderate	Possibly	Unexpected	N/A	No	No
Abatacept	Queen Elizabeth Hospital, Gateshead; N00071	00034	Week 12	Infected leg ulcer	New	Moderate	Possibly	Unexpected	Yes	No	Temporary
Abatacept	Queen Elizabeth Hospital, Gateshead; N00071	00034	Week 12	Ear infection	New	Moderate	Possibly	Unexpected	Yes	No	Temporary

continued

TABLE 75 Line listing of non-SAEs (continued)

Treatment randomised	Centre name and number	Patient number	First reported	AE description	New or pre-existing event?	Intensity	Causality	Expectedness	(For infections) Requested treatment with antibiotics?	SAE or SUSAR?	Stopping of treatment
Abatacept	Queen Elizabeth Hospital, Gateshead; N00071	00034	Week 12	Flu-like symptoms	New	Mild	Unlikely	Unexpected	No	No	Temporary
Abatacept	Queen Elizabeth Hospital, Gateshead; N00071	00034	Week 48	Short of breath? Attributable to MTX	New	Moderate	Possibly	Unexpected	–	No	Temporary
Abatacept	Airedale General Hospital; N00074	00033	Week 12	URTI	New	Moderate	Probably	Expected	No	No	No
Abatacept	Airedale General Hospital; N00074	00078	Week 12	UTI	New	Moderate	Unlikely	Expected	Yes	No	No
Abatacept	Airedale General Hospital; N00074	00078	Week 24	Middle ear infection	New	Moderate	Unlikely	Expected	Yes	No	Temporary
Abatacept	Airedale General Hospital; N00074	00078	Week 36	Back pain	New	Moderate	Unrelated	Unexpected	N/A	No	No
Abatacept	Airedale General Hospital; N00074	00078	Week 36	(Ingrowing toe nail) inflamed big toe	New	Mild	Unrelated	Unexpected	No	No	No
Abatacept	Airedale General Hospital; N00074	00078	Week 48	UTI	Pre-existing	Moderate	Unlikely	Expected	Yes	No	Temporary
Abatacept	Bristol Royal Infirmary; N00117	00145	Week 24	<i>Campylobacter</i> gastroenteritis	New	Moderate	Possibly	Unexpected	Yes	No	No
Abatacept	Derriford Hospital, Plymouth; N00118	00040	Week 12	Chest infection	New	Moderate	Possibly	Unexpected	Yes	No	Temporary
Abatacept	Derriford Hospital, Plymouth; N00118	00040	Week 12	Urinary infection	New	Moderate	Possibly	Expected	Yes	No	Temporary
Abatacept	Derriford Hospital, Plymouth; N00118	00040	Week 24	Tiredness	New	Mild	Possibly	Expected	No	No	No
Abatacept	Derriford Hospital, Plymouth; N00118	00040	Week 48	Urinary infection	New	Moderate	Possibly	Unexpected	Yes	No	No

Treatment randomised	Centre name and number	Patient number	First reported	AE description	New or pre-existing event?	Intensity	Causality	Expectedness	(For infections) Requested treatment with antibiotics?	SAE or SUSAR?	Stopping of treatment
Abatacept	Derriford Hospital, Plymouth; N00118	00068	Week 12	Infected left big toe	New	Moderate	Possibly	Unexpected	Yes	No	No
Abatacept	Derriford Hospital, Plymouth; N00118	00068	Week 48	Patient has a cold and feeling unwell. Treated with amoxicillin 21 January 2015 to 1 week out of 52 and oxytetracycline 4 February 2015 to 1/52	New	Moderate	Unlikely	Unexpected	Yes	Yes	Temporary
Abatacept	King George Hospital, Ilford; N00165	00051	Week 12	Elevated ALP (145 IU/l – range 30 to 130 IU/l)	New	Mild	Possibly	Unexpected	N/A	No	No
Abatacept	King George Hospital, Ilford; N00165	00052	Week 12	(Right) axilla infection of hair follicles	New	Moderate	Possibly	Unexpected	Yes	No	Temporary
Abatacept	King George Hospital, Ilford; N00165	00052	Week 24	Gastroenteritis	New	Mild	Unlikely	Unexpected	No	No	Temporary
Abatacept	Royal Derby Hospital; N00168	00146	Week 12	Chest pain	New	Severe	Unrelated	Unexpected	N/A	Yes	Temporary
Abatacept	Royal Derby Hospital; N00168	00146	Week 24	Upper abdominal pain	Pre-existing	Moderate	Unrelated	Unexpected	N/A	Yes	Temporary
Abatacept	University Hospital, North Durham; N00170	00071	Week 12	UTI	New	Moderate	Possibly	Unexpected	Yes	No	Temporary
Abatacept	University Hospital, North Durham; N00170	00071	Week 12	Mouth ulcers	New	Mild	Possibly	Unexpected	N/A	No	No
Abatacept	University Hospital, North Durham; N00170	00071	Week 12	Sore throat	New	Mild	Possibly	Unexpected	N/A	No	No

continued

TABLE 75 Line listing of non-SAEs (continued)

Treatment randomised	Centre name and number	Patient number	First reported	AE description	New or pre-existing event?	Intensity	Causality	Expectedness	(For infections) Requested treatment with antibiotics?	SAE or SUSAR?	Stopping of treatment
Abatacept	University Hospital, North Durham; N00170	00071	Week 12	Abscess tooth, tooth out	New	Moderate	Possibly	Unexpected	Yes	No	Temporary
Abatacept	Musgrove Park Hospital, Taunton; N00306	00089	Week 36	Right wrist swollen and painful 120-mg Depo injection given	New	Moderate	Missing	Expected	No	No	No
Abatacept	Birmingham City Hospital; N00346	00061	Week 12	Upper respiratory indigestion	New	Moderate	Possibly	Unexpected	No	No	Temporary
Abatacept	Birmingham City Hospital; N00346	00061	Week 24	Upper respiratory injection	Pre-existing	Moderate	Possibly	Unexpected	No	No	No
Abatacept	Birmingham City Hospital; N00346	00061	Week 24	Occasional wheeze	New	Moderate	Possibly	Unexpected	No	No	No
Abatacept	Birmingham City Hospital; N00346	00079	Week 24	UTI	New	Moderate	Unlikely	Unexpected	Yes	No	No
Abatacept	Birmingham City Hospital; N00346	00079	Week 48	Nausea	New	Mild	Unrelated	Unexpected	N/A	No	No
Abatacept	Salford Royal Infirmary; N00400	00074	Week 12	Bruising	New	Mild	Possibly	Unexpected	N/A	No	No
Abatacept	Salford Royal Infirmary; N00400	00074	Week 12	Angiooedema face, tongue, hands	New	Moderate	Possibly	Unexpected	N/A	Yes	No
Abatacept	Salford Royal Infirmary; N00400	00074	Week 12	Angiooedema right cheek	New	Moderate	Possibly	Unexpected	N/A	Yes	No
Abatacept	Salford Royal Infirmary; N00400	00074	Week 24	Mouth ulcers	New	Mild	Possibly	Unexpected	No	No	No
Abatacept	Salford Royal Infirmary; N00400	00074	Week 24	Sickness/nausea	New	Moderate	Unrelated	Unexpected	N/A	No	No
Abatacept	Salford Royal Infirmary; N00400	00074	Week 24	Hypertension	New	Moderate	Unrelated	Unexpected	N/A	No	No



Treatment randomised	Centre name and number	Patient number	First reported	AE description	New or pre-existing event?	Intensity	Causality	Expectedness	(For infections) Requested treatment with antibiotics?	SAE or SUSAR?	Stopping of treatment
Abatacept	Salford Royal Infirmary; N00400	00074	Week 24	Neck pain	New	Moderate	Unrelated	Unexpected	N/A	No	No
Abatacept	Salford Royal Infirmary; N00400	00074	Week 36	Flare of RA (left wrist and left hip)	–	Missing	Missing	Missing	–	Missing	Missing
Abatacept	Salford Royal Infirmary; N00400	00074	Week 48	Pain in hip	Pre-existing	Moderate	Unrelated	Expected	No	No	No
Abatacept	Cannock Chase Hospital; N00473	00106	Week 36	Mouth ulcers	New	Mild	Possibly	Unexpected	No	No	No
Abatacept	Cannock Chase Hospital; N00473	00106	Week 36	Chest (URTI) infection	New	Moderate	Possibly	Unexpected	Yes	No	No
Abatacept	Cannock Chase Hospital; N00473	00106	Week 36	Cellulitis	New	Moderate	Possibly	Unexpected	Yes	No	No
Abatacept	Chapel Allerton Hospital, Leeds; N00482	00002	Week 12	(Right) tooth abscess	New	Moderate	Possibly	Expected	Yes	No	Temporary
Abatacept	Chapel Allerton Hospital, Leeds; N00482	00002	Week 12	Chest infection	New	Moderate	Possibly	Expected	Yes	No	Temporary
Abatacept	Chapel Allerton Hospital, Leeds; N00482	00006	Week 36	UTI	New	Moderate	Unlikely	Expected	Yes	No	Temporary
Abatacept	Chapel Allerton Hospital, Leeds; N00482	00009	Week 48	Flu illness with URTI	New	Moderate	Unrelated	Expected	Yes	No	Temporary
Abatacept	Chapel Allerton Hospital, Leeds; N00482	00014	Week 24	Chest infection	New	Moderate	Possibly	Expected	Yes	No	Temporary
Abatacept	Chapel Allerton Hospital, Leeds; N00482	00016	Week 12	Back pain after getting up from chair	New	Severe	Unrelated	Unexpected	N/A	No	No

continued

TABLE 75 Line listing of non-SAEs (continued)

Treatment randomised	Centre name and number	Patient number	First reported	AE description	New or pre-existing event?	Intensity	Causality	Expectedness	(For infections) Requested treatment with antibiotics?	SAE or SUSAR?	Stopping of treatment
Abatacept	Chapel Allerton Hospital, Leeds; N00482	00016	Week 12	Nausea and change in smell	New	Mild	Unrelated	Unexpected	N/A	No	No
Abatacept	Chapel Allerton Hospital, Leeds; N00482	00021	Week 24	Foot ulcer right MTP 1	New	Moderate	Possibly	Expected	Yes	No	Temporary
Abatacept	Chapel Allerton Hospital, Leeds; N00482	00026	Week 12	Mild hair loss	New	Mild	Possibly	Expected	N/A	No	No
Abatacept	Chapel Allerton Hospital, Leeds; N00482	00026	Week 24	Swelling and lumps on both sides of the neck	New	Mild	Unlikely	Unexpected	N/A	No	No
Abatacept	Chapel Allerton Hospital, Leeds; N00482	00026	Week 48	Chest infection	New	Moderate	Possibly	Expected	Yes	No	No
Abatacept	Chapel Allerton Hospital, Leeds; N00482	00038	Week 36	Sinusitis	New	Moderate	Possibly	Expected	Yes	No	Temporary
Abatacept	Chapel Allerton Hospital, Leeds; N00482	00038	Week 36	Laryngitis	New	Moderate	Possibly	Expected	Yes	No	Temporary
Abatacept	Chapel Allerton Hospital, Leeds; N00482	00102	Week 36	Cold	New	Mild	Probably	Expected	No	No	No
Abatacept	Chapel Allerton Hospital, Leeds; N00482	00103	Week 36	Cold	New	Mild	Probably	Expected	No	No	No
Abatacept	Chapel Allerton Hospital, Leeds; N00482	00137	Week 12	URTI	New	Moderate	Probably	Expected	Yes	No	No

Treatment randomised	Centre name and number	Patient number	First reported	AE description	New or pre-existing event?	Intensity	Causality	Expectedness	(For infections) Requested treatment with antibiotics?	SAE or SUSAR?	Stopping of treatment
Abatacept	Chapel Allerton Hospital, Leeds; N00482	00137	Week 36	Tooth abscess	New	Moderate	Probably	Expected	Yes	No	Temporary
Abatacept	Chapel Allerton Hospital, Leeds; N00482	00137	Week 48	Hair loss	Pre-existing	Moderate	Probably	Expected	N/A	No	Permanent
Abatacept	Broadgreen Hospital, Liverpool; N00589	00130	Week 12	Laryngeal inflammation	New	Mild	Unlikely	Unexpected	N/A	No	No
Abatacept	Royal National Hospital for Rheumatic Diseases, Bath N02220	00077	Week 12	Chest infection	New	Moderate	Possibly	Expected	Yes	No	Temporary
Abatacept	Royal National Hospital for Rheumatic Diseases, Bath N02220	00077	Week 12	Chest infection	New	Moderate	Possibly	Expected	Yes	No	Temporary
Abatacept	Royal National Hospital for Rheumatic Diseases, Bath N02220	00077	Week 12	Infected dog scratch	New	Moderate	Unrelated	Unexpected	Yes	No	Temporary
Abatacept	Royal National Hospital for Rheumatic Diseases, Bath N02220	00123	Week 36	UTI low backache. No fever, dysuria, frequency	New	Moderate	Possibly	Unexpected	Yes	No	No
Abatacept	Royal National Hospital for Rheumatic Diseases, Bath N02220	00123	Week 36	UTI low backache no fever, dysuria, frequency	New	Moderate	Possibly	Unexpected	Yes	No	No
Abatacept	Royal National Hospital for Rheumatic Diseases, Bath N02220	00125	Week 12	Severe flare – widespread pain and stiffness, bed/ chairbound, assessed by out-of-hours GP	New	Severe	Unrelated	Unexpected	N/A	No	No

continued

TABLE 75 Line listing of non-SAEs (continued)

Treatment randomised	Centre name and number	Patient number	First reported	AE description	New or pre-existing event?	Intensity	Causality	Expectedness	(For infections) Requested treatment with antibiotics?	SAE or SUSAR?	Stopping of treatment
Rituximab	New Cross Hospital, Wolverhampton; N00034	00142	Week 36	Rash – forearms and trunk	New	Mild	Possibly	Unexpected	No	No	No
Rituximab	Queen Elizabeth Hospital, Gateshead; N00071	00031	Week 24	Vomited (once)	New	Mild	Possibly	Unexpected	N/A	No	No
Rituximab	Queen Elizabeth Hospital, Gateshead; N00071	00037	Week 24	Metastatic melanoma	New	Life-threatening	Unrelated	Unexpected	N/A	Yes	Permanent
Rituximab	Queen Elizabeth Hospital, Gateshead; N00071	00066	Week 12	Rash	New	Moderate	Possibly	Unexpected	No	No	No
Rituximab	Airedale General Hospital; N00074	00058	Week 12	White cells $3.4 \times 10^9/l$ (below normal limit)	New	Mild	Unrelated	Expected	No	No	Temporary
Rituximab	Airedale General Hospital; N00074	00058	Week 12	Neutrophils $1.74 \times 10^9/l$ (below normal limit)	New	Mild	Unrelated	Expected	No	No	Temporary
Rituximab	Airedale General Hospital; N00074	00058	Week 24	White cell count ( $3.1 \times 10^9/l$ , $3.3 \times 10^9/l$ , $3.3 \times 10^9/l$ )	New	Mild	Unrelated	Expected	No	No	Temporary
Rituximab	Airedale General Hospital; N00074	00058	Week 24	Low neutrophils ( $1.45 \times 10^9/l$ , $1.45 \times 10^9/l$ , $1.62 \times 10^9/l$ )	New	Mild	Unrelated	Expected	No	No	Temporary
Rituximab	Airedale General Hospital; N00074	00058	Week 36	Cystitis	New	Moderate	Unrelated	Expected	Yes	No	No
Rituximab	Airedale General Hospital; N00074	00058	Week 36	Raised ALT (55 g/l)	Pre-existing	Mild	Unrelated	Expected	N/A	No	Temporary
Rituximab	Airedale General Hospital; N00074	00058	Week 48	Around 15 November 2014 croaky voice	New	Moderate	Possibly	Expected	No	No	No
Rituximab	Airedale General Hospital; N00074	00058	Week 48	Around 15 November 2014 (ongoing) blocked nose (took paracetamol on the weekend when she felt worse)	New	Moderate	Possibly	Expected	No	No	No

Treatment randomised	Centre name and number	Patient number	First reported	AE description	New or pre-existing event?	Intensity	Causality	Expectedness	(For infections) Requested treatment with antibiotics?	SAE or SUSAR?	Stopping of treatment
Rituximab	Hull Royal Infirmary; N00078	00149	Week 12	Ruptured sebaceous cyst	New	Mild	Unrelated	Unexpected	N/A	No	No
Rituximab	Hull Royal Infirmary; N00078	00149	Week 24	Urine infection	New	Mild	Unrelated	Unexpected	Yes	No	No
Rituximab	Manchester Royal Infirmary; N00080	00013	Week 12	Chest infection	New	Moderate	Possibly	Expected	Yes	No	No
Rituximab	Manchester Royal Infirmary; N00080	00013	Week 48	Neutropenia	New	Moderate	Unrelated	Unexpected	N/A	No	Temporary
Rituximab	Manchester Royal Infirmary; N00080	00017	Week 12	Widespread soft tissue tenderness	New	Mild	Possibly	Unexpected	N/A	No	No
Rituximab	Manchester Royal Infirmary; N00080	00017	Week 12	No sleep for past 2 days	New	Mild	Unlikely	Unexpected	N/A	No	No
Rituximab	Manchester Royal Infirmary; N00080	00017	Week 36	Longstanding wind in stomach	Pre-existing	Mild	Unrelated	Unexpected	N/A	No	No
Rituximab	Manchester Royal Infirmary; N00080	00056	Week 24	Low white cell count	New	Moderate	Almost certainly	Unexpected	N/A	No	Permanent
Rituximab	Manchester Royal Infirmary; N00080	00056	Week 24	Mouth ulcer	New	Moderate	Almost certainly	Unexpected	N/A	No	No
Rituximab	Manchester Royal Infirmary; N00080	00092	Week 12	Increased fatigue	New	Mild	Possibly	Unexpected	N/A	No	No
Rituximab	Manchester Royal Infirmary; N00080	00092	Week 12	Slight breathlessness at night	New	Mild	Possibly	Unexpected	N/A	No	No
Rituximab	Manchester Royal Infirmary; N00080	00092	Week 36	Left hand injury	New	Moderate	Unrelated	Unexpected	N/A	No	No
Rituximab	Poole Hospital; N00108	00075	Week 12	Rash to upper arms	New	Mild	Unlikely	Unexpected	N/A	No	No
Rituximab	Poole Hospital; N00108	00075	Week 36	Submitted Yellow Card for severe skin reaction	New	Moderate	Probably	Unexpected	No	No	Permanent

continued

**TABLE 75** Line listing of non-SAEs (*continued*)

Treatment randomised	Centre name and number	Patient number	First reported	AE description	New or pre-existing event?	Intensity	Causality	Expectedness	(For infections) Requested treatment with antibiotics?	SAE or SUSAR?	Stopping of treatment
Rituximab	Queen Alexandra Hospital, Portsmouth; N00110	00148	Week 12	Infusion reaction on first rituximab infusion 27 November 2014. Treated with intravenous hydrocortisone infusion stopped then restarted: no further infusion reactions	New	Moderate	Unlikely	Unexpected	No	No	No
Rituximab	Queen Alexandra Hospital, Portsmouth; N00110	00148	Week 48	Patient reports hair loss – MTX dose reduced to 10 mg weekly	New	Mild	Unrelated	Expected	N/A	No	No
Rituximab	Derriford Hospital, Plymouth; N00118	00025	Week 24	Abscess on mouth mucosa	New	Moderate	Possibly	Unexpected	Yes	No	No
Rituximab	Derriford Hospital, Plymouth; N00118	00025	Week 48	Lower back pain	Pre-existing	Moderate	Unlikely	Unexpected	N/A	No	No
Rituximab	King George Hospital, Ilford; N00165	00030	Week 12	Suspected UTI	New	Moderate	Unlikely	Unexpected	Yes	No	No
Rituximab	King George Hospital, Ilford; N00165	00030	Week 24	Chest infection	Pre-existing	Moderate	Probably	Expected	Yes	No	Temporary
Rituximab	King George Hospital, Ilford; N00165	00030	Week 24	Chest infection	Pre-existing	Moderate	Probably	Expected	Yes	No	Temporary
Rituximab	King George Hospital, Ilford; N00165	00030	Week 24	Exacerbation of asthma	New	Moderate	Unlikely	Unexpected	N/A	No	No
Rituximab	King George Hospital, Ilford; N00165	00030	Week 24	Shingles	New	Moderate	Probably	Expected	Yes	No	No

Treatment randomised	Centre name and number	Patient number	First reported	AE description	New or pre-existing event?	Intensity	Causality	Expectedness	(For infections) Requested treatment with antibiotics?	SAE or SUSAR?	Stopping of treatment
Rituximab	King George Hospital, Ilford; N00165	00030	Week 36	(Right) sided suspected pleurisy	New	Severe	Unlikely	Unexpected	Yes	No	Temporary
Rituximab	University Hospital, North Durham; N00170	00083	Week 12	ALT raised	New	Moderate	Unlikely	Unexpected	N/A	No	No
Rituximab	University Hospital, North Durham; N00170	00083	Week 24	Eye infection treated with antibiotic eye ointment by GP	New	Mild	Possibly	Unexpected	Yes	No	No
Rituximab	University Hospital, North Durham; N00170	00083	Week 36	Flare	New	Moderate	Unrelated	Unexpected	N/A	No	No
Rituximab	University Hospital, North Durham; N00170	00083	Week 48	(Light) knee swollen (inner) painful	New	Moderate	Unlikely	Unexpected	N/A	No	No
Rituximab	University Hospital, North Durham; N00170	00107	Week 12	22 October 2014 shortness of breath	New	Moderate	Unlikely	Unexpected	Yes	No	No
Rituximab	University Hospital, North Durham; N00170	00107	Week 24	Chest infection	New	Moderate	Possibly	Unexpected	Yes	No	No
Rituximab	University Hospital, North Durham; N00170	00107	Week 24	Vertigo	New	Moderate	Possibly	Unexpected	N/A	No	No
Rituximab	Nuffield Orthopaedic Centre, Oxford; N00282	00104	Week 12	Neutropenia, $0.69 \times 10^9/l$	New	Moderate	Possibly	Expected	No	No	Temporary
Rituximab	Nuffield Orthopaedic Centre, Oxford; N00282	00104	Week 24	URTI	New	Moderate	Possibly	Expected	No	No	No

continued

**TABLE 75** Line listing of non-SAEs (*continued*)

Treatment randomised	Centre name and number	Patient number	First reported	AE description	New or pre-existing event?	Intensity	Causality	Expectedness	(For infections) Requested treatment with antibiotics?	SAE or SUSAR?	Stopping of treatment
Rituximab	Nuffield Orthopaedic Centre, Oxford; N00282	00104	Week 24	Burn on hand	New	Mild	Unrelated	Unexpected	No	No	No
Rituximab	Nuffield Orthopaedic Centre, Oxford; N00282	00104	Week 24	Headaches	New	Mild	Probably	Expected	No	No	No
Rituximab	Nuffield Orthopaedic Centre, Oxford; N00282	00104	Week 24	Temporomandibular pain	New	Mild	Unrelated	Expected	No	No	No
Rituximab	Nuffield Orthopaedic Centre, Oxford; N00282	00104	Week 36	Carditis, 9 February 2015, co-amoxiclav	New	Moderate	Unrelated	Expected	Yes	No	No
Rituximab	Nuffield Orthopaedic Centre, Oxford; N00282	00104	Week 36	Viral infection, 2–3 weeks	New	Mild	Possibly	Expected	No	No	No
Rituximab	Birmingham City Hospital; N00346	00132	Week 12	Rash skin	New	Moderate	Probably	Expected	N/A	No	No
Rituximab	Salford Royal Infirmary; N00400	00113	Week 36	Gastritis	New	Moderate	Unrelated	Expected	No	No	No
Rituximab	Cannock Chase Hospital; N00473	00036	Week 12	Worsening depression (following bereavement)	New	Moderate	Unrelated	Unexpected	N/A	No	No
Rituximab	Cannock Chase Hospital; N00473	00036	Week 24	Leg cramps at night	New	Mild	Unlikely	Unexpected	N/A	No	No
Rituximab	Cannock Chase Hospital; N00473	00036	Week 36	Upper back pain	New	Moderate	Unrelated	Unexpected	N/A	No	No



Treatment randomised	Centre name and number	Patient number	First reported	AE description	New or pre-existing event?	Intensity	Causality	Expectedness	(For infections) Requested treatment with antibiotics?	SAE or SUSAR?	Stopping of treatment
Rituximab	Cannock Chase Hospital; N00473	00036	Week 36	Unstable hypertension	New	Mild	Unrelated	Unexpected	N/A	No	No
Rituximab	Cannock Chase Hospital; N00473	00036	Week 36	Elevated lipids	Pre-existing	Mild	Unrelated	Unexpected	N/A	No	No
Rituximab	Cannock Chase Hospital; N00473	00045	Week 48	Mouth ulcers	New	Mild	Unlikely	Unexpected	N/A	No	No
Rituximab	Cannock Chase Hospital; N00473	00045	Week 48	Chest infection	New	Mild	Unlikely	Expected	No	No	No
Rituximab	Cannock Chase Hospital; N00473	00098	Week 12	Diabetic peripheral neuropathy (longstanding)	New	Mild	Unrelated	Unexpected	N/A	No	No
Rituximab	Cannock Chase Hospital; N00473	00098	Week 24	Left trochanteric bursitis	New	Moderate	Unrelated	Unexpected	N/A	No	No
Rituximab	Cannock Chase Hospital; N00473	00098	Week 36	Hair thinning	New	Mild	Unlikely	Unexpected	N/A	No	No
Rituximab	Cannock Chase Hospital; N00473	00098	Week 36	Intermittent numbness of upper limbs	New	Mild	Unlikely	Unexpected	N/A	No	No
Rituximab	Cannock Chase Hospital; N00473	00114	Week 12	UTI	New	Mild	Possibly	Expected	Yes	No	No
Rituximab	Cannock Chase Hospital; N00473	00114	Week 12	Tremor, right hand	New	Mild	Unrelated	Unexpected	N/A	No	No
Rituximab	Cannock Chase Hospital; N00473	00114	Week 24	Cough	New	Moderate	Unlikely	Unexpected	No	No	No
Rituximab	Cannock Chase Hospital; N00473	00114	Week 24	UTI	New	Moderate	Unlikely	Unexpected	Yes	No	No
Rituximab	Cannock Chase Hospital; N00473	00114	Week 36	Cough	New	Moderate	Unlikely	Unexpected	No	No	Permanent
Rituximab	Cannock Chase Hospital; N00473	00114	Week 36	Sterile pyuria	New	Moderate	Unlikely	Unexpected	No	No	Permanent

continued

**TABLE 75** Line listing of non-SAEs (*continued*)

Treatment randomised	Centre name and number	Patient number	First reported	AE description	New or pre-existing event?	Intensity	Causality	Expectedness	(For infections) Requested treatment with antibiotics?	SAE or SUSAR?	Stopping of treatment
Rituximab	Cannock Chase Hospital; N00473	00114	Week 36	Oral thrush	New	Moderate	Unlikely	Unexpected	N/A	No	Permanent
Rituximab	Cannock Chase Hospital; N00473	00114	Week 36	Flare of RA	New	Moderate	Unlikely	Unexpected	N/A	No	Permanent
Rituximab	Chapel Allerton Hospital, Leeds; N00482	00003	Week 24	Skin rash (left wrist)	New	Mild	Possibly	Unexpected	N/A	No	No
Rituximab	Chapel Allerton Hospital, Leeds; N00482	00003	Week 24	Lower respiratory chest infection	New	Mild	Possibly	Unexpected	Yes	No	No
Rituximab	Chapel Allerton Hospital, Leeds; N00482	00003	Week 48	(Left) ear deafness? Eustachian tube dysfunction	New	Moderate	Unlikely	Unexpected	N/A	No	No
Rituximab	Chapel Allerton Hospital, Leeds; N00482	00003	Week 48	Cough and dry 1 month out of 12	New	Moderate	Possibly	Unexpected	N/A	No	No
Rituximab	Chapel Allerton Hospital, Leeds; N00482	00007	Week 12	Lower respiratory chest infection (January 2013)	New	Moderate	Possibly	Unexpected	Yes	No	No
Rituximab	Chapel Allerton Hospital, Leeds; N00482	00007	Week 12	Lower respiratory chest infection (7 March 2013)	New	Moderate	Possibly	Unexpected	Yes	No	Temporary
Rituximab	Chapel Allerton Hospital, Leeds; N00482	00007	Week 24	Chest infection	New	Mild	Possibly	Unexpected	Yes	No	No
Rituximab	Chapel Allerton Hospital, Leeds; N00482	00008	Week 24	Acute abdominal pain over previous hysterectomy scar	New	Severe	Unlikely	Unexpected	N/A	Yes	No
Rituximab	Chapel Allerton Hospital, Leeds; N00482	00015	Week 24	(Right) groin pain	New	Mild	Unrelated	Expected	N/A	No	No

Treatment randomised	Centre name and number	Patient number	First reported	AE description	New or pre-existing event?	Intensity	Causality	Expectedness	(For infections) Requested treatment with antibiotics?	SAE or SUSAR?	Stopping of treatment
Rituximab	Chapel Allerton Hospital, Leeds; N00482	00019	Week 12	Urticarial rash with faster infusion rituximab	New	Moderate	Almost certainly	Expected	N/A	No	No
Rituximab	Chapel Allerton Hospital, Leeds; N00482	00019	Week 24	Headaches twice with MTX	Pre-existing	Mild	Possibly	Expected	N/A	No	No
Rituximab	Chapel Allerton Hospital, Leeds; N00482	00019	Week 36	Tooth infection	New	Moderate	Probably	Expected	Yes	No	Temporary
Rituximab	Chapel Allerton Hospital, Leeds; N00482	00047	Week 48	Sinusitis	New	Moderate	Probably	Expected	Yes	No	Temporary
Rituximab	Chapel Allerton Hospital, Leeds; N00482	00055	Week 48	Chest infection	New	Moderate	Probably	Expected	Yes	No	No
Rituximab	Chapel Allerton Hospital, Leeds; N00482	00080	Week 36	Chest infection	New	Moderate	Possibly	Expected	Yes	No	No
Rituximab	Chapel Allerton Hospital, Leeds; N00482	00082	Week 36	Blepharitis (left eye)	New	Moderate	Unlikely	Unexpected	N/A	No	No
Rituximab	Chapel Allerton Hospital, Leeds; N00482	00101	Week 36	UTI (cystitis)	New	Moderate	Probably	Expected	Yes	No	Temporary
Rituximab	Chapel Allerton Hospital, Leeds; N00482	00101	Week 48	Wound infection	New	Moderate	Possibly	Expected	Yes	No	Temporary

ALP, alkaline phosphatase; ALT, alanine aminotransferase; b.p.m., beats per minutes; COPD, chronic obstructive pulmonary disease; CTCAE, Common Terminology Criteria for Adverse Events; LRTI, lower respiratory tract infection; MTP 1, first metatarsophalangeal joint; URTI, upper respiratory tract infection; UTI, urinary tract infection.



## Appendix 15 Supplementary health economics tables

**TABLE 76** Resource use: unit costs

Type of service	Cost (£)	Unit of measure	Notes	Source
<b>Community-based health and social services</b>				
GP, surgery visit	44.00	Per visit	GP, per patient contact lasting 11.7 minutes including direct care staff costs	PSSRU <i>Unit Costs of Health and Social Care 2015</i> , p. 177 <sup>127</sup>
GP, surgery telephone	27.00	Per telephone call	GP, per telephone consultation lasting 7.1 minutes	PSSRU <i>Unit Costs of Health and Social Care 2015</i> , p. 177 <sup>127</sup>
GP, home visit	90.00	Per home visit	(Per patient contact lasting 11.7 minutes + average 12-minute travel time) × £3.80/minute cost of patient	PSSRU <i>Unit Costs of Health and Social Care 2015</i> , p. 177 <sup>127</sup>
District nurse face to face	37.26	Per visit	District nurse, adult, face to face	<i>NHS Reference Costs 2014 to 2015</i> <sup>128</sup>
District nurse telephone/e-mail	16.53		District nurse, adult non-face to face	<i>NHS Reference Costs 2014 to 2015</i> <sup>128</sup>
Social worker face to face	79.00	Per visit	Assuming 1-hour appointment	PSSRU <i>Unit Costs of Health and Social Care 2015</i> , p. 188 <sup>127</sup>
Social worker telephone/e-mail	9.34		Assuming telephone consultation lasting 7.1 minutes, based on cost per hour	PSSRU <i>Unit Costs of Health and Social Care 2015</i> , p. 188 <sup>127</sup>
Physiotherapist face to face	52.00	Per appointment	Community physiotherapist mean cost for one-to-one contact	<i>NHS Reference Costs 2014 to 2015</i> <sup>128</sup>
Physiotherapist telephone/e-mail	35.00		Physiotherapy non-admitted non-face-to-face follow-up, consultant led	<i>NHS Reference Costs 2014 to 2015</i> <sup>128</sup>
Occupational therapist face to face	44.00	Per appointment	NHS community occupational therapist	PSSRU <i>Unit Costs of Health and Social Care 2015</i> , p. 191 <sup>127</sup>
Occupational therapist telephone/e-mail	9.00		Occupational therapy consultant-led non-admitted non-face-to-face follow-up (first cost = £17.00)	<i>NHS Reference Costs 2014 to 2015</i> <sup>128</sup>
Podiatrist face to face	39.63	Per appointment		<i>NHS Reference Costs 2014 to 2015</i> <sup>128</sup>
Podiatrist telephone/e-mail	18.00		Podiatry non-admitted non-face-to-face follow-up (first cost = £30.00)	<i>NHS Reference Costs 2014 to 2015</i> <sup>128</sup>
Counsellor face to face	50.79	Per appointment	Assuming 1-hour appointment	PSSRU <i>Unit Costs of Health and Social Care 2014</i> , p. 51 <sup>148</sup> and EPPI-Centre Cost Converter to 2015 price, URL: <a href="http://eppi.ioe.ac.uk/costconversion/Default.aspx">http://eppi.ioe.ac.uk/costconversion/Default.aspx</a>

continued

TABLE 76 Resource use: unit costs (continued)

Type of service	Cost (£)	Unit of measure	Notes	Source
Counsellor telephone/e-mail	6.01		Assuming telephone consultation lasting 7.1 minutes, based on cost per hour	PSSRU <i>Unit Costs of Health and Social Care 2014</i> , p. 51 <sup>148</sup> and EPPI-Centre Cost Converter to 2015 price, URL: <a href="http://eppi.ioe.ac.uk/costconversion/Default.aspx">http://eppi.ioe.ac.uk/costconversion/Default.aspx</a>
Psychiatrist or psychologist face to face	61.96	Per visit	Clinical psychologist per hour	PSSRU <i>Unit Costs of Health and Social Care 2014</i> , p. 183 <sup>148</sup> and EPPI-Centre Cost Converter to 2015 price, URL: <a href="http://eppi.ioe.ac.uk/costconversion/Default.aspx">http://eppi.ioe.ac.uk/costconversion/Default.aspx</a>
Psychiatrist or psychologist telephone/e-mail	34.00		Clinical psychology non-admitted non-face-to-face follow-up (first cost = £31.00)	<i>NHS Reference Costs 2014 to 2015</i> <sup>128</sup>
Home help or care workers face to face	24.00	Per session	Face-to-face 1-hour weekday session	PSSRU <i>Unit Costs of Health and Social Care 2015</i> , p. 192 <sup>127</sup>
Home help or care workers telephone/e-mail	2.84		Assuming telephone consultation lasting 7.1 minutes, based on cost per hour	PSSRU <i>Unit Costs of Health and Social Care 2015</i> , p. 192 <sup>127</sup>
Practice nurse	12.14	Per 15.5-minute consultation	Based on £47 per hour	PSSRU <i>Unit Costs of Health and Social Care 2015</i> , p. 174 <sup>127</sup>
Specialist nurse telephone	7.69		Assuming telephone consultation lasting 7.1 minutes, based on £65 per hour	PSSRU <i>Unit Costs of Health and Social Care 2015</i> , p. 172 <sup>127</sup>
Hydrotherapy pool	27.00		Physiotherapy non-admitted, non-face to face, non-consultant led	<i>NHS Reference Costs 2014 to 2015</i> <sup>128</sup>
<b>Hospital-based or residential care services</b>				
Hospital inpatient stay	303.00	Per day	General ward, non-elective inpatients – excess bed-days	<i>NHS Reference Costs 2014 to 2015</i> <sup>128</sup>
Hospital day centre	160.00	Per visit	Inpatient specialist palliative care, same day	<i>NHS Reference Costs 2014 to 2015</i> <sup>128</sup>
Hospital outpatient clinic	112.00	Per visit	Weighted average of all outpatient attendances	PSSRU <i>Unit Costs of Health and Social Care 2015</i> , p. 107 <sup>127</sup>
Hospital accident and emergency department	132.00	Per visit	Emergency medicine	<i>NHS Reference Costs 2014 to 2015</i> <sup>128</sup>
Nursing home	88.71	Per day	Assume cost for 1 day and night equals the reported private sector nursing home cost per week/7	PSSRU <i>Unit Costs of Health and Social Care 2015</i> , p. 37 <sup>127</sup>
Residential home	72.00	Per day	Assume cost for 1 day and night equals the reported private sector residential home cost per week/7	PSSRU <i>Unit Costs of Health and Social Care 2015</i> , p. 38 <sup>127</sup>
<b>Inpatient procedures</b>				
Oral surgery (dental clearance)	154.00		Oral surgery, extraction of multiple teeth aged ≥ 19 years	<i>NHS Reference Costs 2014 to 2015</i> <sup>128</sup>
Excision of cystic swelling	2054.30		Minor foot procedures for non-trauma, inpatient elective	<i>NHS Reference Costs 2014 to 2015</i> <sup>128</sup>

TABLE 76 Resource use: unit costs (*continued*)

Type of service	Cost (£)	Unit of measure	Notes	Source
<b>Rheumatology visits</b>				
Day-case rheumatology	421.00		Day case inflammatory, spine, joint or connective tissue disorders, with CC score 0–2	DH's <i>NHS Reference Costs 2014 to 2015</i> (HD23J) <sup>128</sup>
Outpatient rheumatology, first attendance	162.00		Non-admitted face to face, first	DH's <i>NHS Reference Costs 2014 to 2015</i> (WF01B) <sup>128</sup>
Outpatient rheumatology, follow-up attendance	91.00		Non-admitted face to face follow-up	DH's <i>NHS Reference Costs 2014 to 2015</i> (WF01A) <sup>128</sup>
Staff nurse	36.00		Cost per hour	PSSRU's <i>Unit Costs of Health and Social Care 2015</i> <sup>127</sup>
Nurse specialist	45.00		Cost per hour	PSSRU's <i>Unit Costs of Health and Social Care 2015</i> <sup>127</sup>

CC score, case mix classification score; DH, Department of Health.

TABLE 77 Trial medication costs

Medication	Dose	Cost per dose	Unit cost (£)	Description	Source
Rituximab	First cycle: 1 g as an intravenous infusion at days 0 (week 0) and 15 (week 2; + 5 days)  Second cycle: 1 g as an intravenous infusion at 2-week interval	£1746.30	873.15	10 mg/ml of a 50-ml vial concentrate for intravenous infusion	BNF <sup>130</sup>
Abatacept	125 mg by subcutaneous injection at week 0 and once weekly thereafter for a minimum of 24 weeks	£302.40	302.40	125-mg prefilled pen or prefilled syringe	BNF <sup>130</sup>
Infliximab	3 mg/kg per intravenous infusion to be administered at weeks 0, 2 and 6 then 8-weekly thereafter for minimum 24 weeks		419.62	100-mg vial	BNF <sup>130</sup>
Etanercept	50 mg by subcutaneous injection weekly for minimum 24 weeks	£178.75	178.75	50-mg prefilled pen or prefilled syringe	BNF <sup>130</sup>
Adalimumab	40 mg by subcutaneous injection every 2 weeks for a minimum of 24 weeks	£352.14	352.14	40-mg prefilled pen or prefilled syringe	BNF <sup>130</sup>
CZP	400 mg by subcutaneous injection at weeks 0, 2 and 4, then 200 mg every 2 weeks thereafter for a minimum of 24 weeks	400-mg dose, £715.00; 200-mg dose, £357.50	357.50	200-mg prefilled syringe	BNF <sup>130</sup>
Golimumab	50 mg of self-administered subcutaneous injection monthly, same date each month	£762.97	762.97	50-mg prefilled pen or prefilled syringe	BNF <sup>130</sup>

TABLE 78 Trial drug administration costs

Treatment	Hours of nurse supervision for intravenous drug administration per treatment	Intravenous equipment required per treatment <sup>a</sup>	Educational visit, outpatient, rheumatology (first attendance)	Safety check: visit staff nurse (week 4)	Administration cost (£)
Etanercept	–	–	1	1	198
Adalimumab	–	–	1	1	198
CZP	–	–	1	1	198
Abatacept	–	–	1	1	198
Golimumab	–	–	1	1	198
Infliximab	2	1	–	–	98.66
Rituximab	7	1	–	–	278.66

a Cost of intravenous equipment was taken from relevant literature<sup>149</sup> and inflated to the current year prices (pounds sterling) using an online inflator.<sup>131</sup>



**TABLE 79** Average resource use per patient in each trial arm<sup>a,b</sup>

Resource	Time point											
	12 weeks			24 weeks			36 weeks			48 weeks		
	Treatment arm											
	Rituximab (n = 29)	Abatacept (n = 26)	TNFi (n = 25)	Rituximab (n = 29)	Abatacept (n = 26)	TNFi (n = 25)	Rituximab (n = 29)	Abatacept (n = 26)	TNFi (n = 25)	Rituximab (n = 29)	Abatacept (n = 26)	TNFi (n = 25)
<b>Community Health and Social Services</b>												
<i>GP surgery visit</i>												
Face to face												
Mean (SD)	1.48 (1.70)	1.23 (2.1)	1 (1.26)	2.1 (2.78)	1.46 (1.56)	1.32 (1.44)	2.52 (4.47)	1.81 (1.39)	2.2 (2.87)	3 (3.74)	1.69 (1.83)	1.8 (1.76)
Minimum	0	0	0	0	0	0	0	0	0	0	0	0
Maximum	6	10	3	10	6	4	20	5	12	12	6	6
Telephone/e-mail												
Mean (SD)	0.86 (1.73)	0.12 (0.33)	0.44 (1.26)	0.31 (0.93)	0.15 (0.46)	0.48 (1.05)	0.45 (1.15)	0.77 (0.27)	0.32 (0.9)	0.72 (2.37)	0.23 (1.18)	0.2 (0.58)
Minimum	0	0	0	0	0	0	0	0	0	0	0	0
Maximum	6	1	5	4	2	4	5	1	3	12	6	2
<i>GP home visit</i>												
Face to face												
Mean (SD)	0	0	0	0.14 (0.52)	0	0	0.1 (0.56)	0.08 (0.39)	0	0	0	0.04 (0.2)
Minimum	0	0	0	0	0	0	0	0	0	0	0	0
Maximum	0	0	0	2	0	0	3	2	0	0	0	1
<i>District nurse</i>												
Face to face												
Mean (SD)	0.14 (0.58)	0.27 (0.83)	0.44 (1.04)	0.14 (0.58)	0.23 (0.82)	0.32 (0.9)	0.21 (0.77)	0.19 (0.69)	0.04 (0.2)	0.24 (1.12)	0.12 (0.59)	0.48 (1.23)
Minimum	0	0	0	0	0	0	0	0	0	0	0	0
Maximum	3	3	3	3	3	3	3	3	1	6	3	5

continued

**TABLE 79** Average resource use per patient in each trial arm<sup>a, b</sup> (continued)

Resource	Time point											
	12 weeks			24 weeks			36 weeks			48 weeks		
	Treatment arm											
	Rituximab (n = 29)	Abatacept (n = 26)	TNFi (n = 25)	Rituximab (n = 29)	Abatacept (n = 26)	TNFi (n = 25)	Rituximab (n = 29)	Abatacept (n = 26)	TNFi (n = 25)	Rituximab (n = 29)	Abatacept (n = 26)	TNFi (n = 25)
<b>Telephone/e-mail</b>												
Mean (SD)	0	0.15 (0.78)	0	0	0	0	0	0	0	0.03 (0.19)	0.12 (0.59)	0.08 (0.4)
Minimum	0	0	0	0	0	0	0	0	0	0	0	0
Maximum	0	4	0	0	0	0	0	0	0	1	3	2
<b>Social worker</b>												
<b>Face to face</b>												
Mean (SD)	0	0	0	0.03 (0.19)	0	0	0	0	0	0.07 (0.26)	0	0
Minimum	0	0	0	0	0	0	0	0	0	0	0	0
Maximum	0	0	0	1	0	0	0	0	0	1	0	0
<b>Telephone/e-mail</b>												
Mean (SD)	0.03 (0.19)	0	0	0	0	0	0	0	0	0.03 (0.19)	0	0
Minimum	0	0	0	0	0	0	0	0	0	0	0	0
Maximum	1	0	0	0	0	0	0	0	0	1	0	0
<b>Physiotherapist</b>												
<b>Face to face</b>												
Mean (SD)	0.38 (0.19)	0.54 (1.9)	0	0.52 (2.05)	0	0.6 (1.94)	0.76 (2.85)	1.81 (7.91)	0.64 (1.87)	1.48 (3.3)	0.54 (1.82)	0.12 (0.44)
Minimum	0	0	0	0	0	0	0	0	0	0	0	0
Maximum	8	7	0	10	0	7	12	40	7	12	8	2

Resource	Time point											
	12 weeks			24 weeks			36 weeks			48 weeks		
	Treatment arm											
	Rituximab (n = 29)	Abatacept (n = 26)	TNFi (n = 25)	Rituximab (n = 29)	Abatacept (n = 26)	TNFi (n = 25)	Rituximab (n = 29)	Abatacept (n = 26)	TNFi (n = 25)	Rituximab (n = 29)	Abatacept (n = 26)	TNFi (n = 25)
<i>Telephone/e-mail</i>												
Mean (SD)	0	0	0	0	0	0	0.07 (0.37)	0	0	0.34 (1.86)	0.04 (0.2)	0
Minimum	0	0	0	0	0	0	0	0	0	0	0	0
Maximum	0	0	0	0	0	0	2	0	0	10	1	0
<i>Occupational therapist</i>												
<i>Face to face</i>												
Mean (SD)	0	0.15 (0.54)	0	0.1 (0.41)	0.08 (0.39)	0.04 (0.2)	0.1 (0.41)	0	0.2 (1)	0.21 (0.68)	0.31 (0.62)	0.08 (0.4)
Minimum	0	0	0	0	0	0	0	0	0	0	0	0
Maximum	0	2	0	2	2	1	2	0	5	3	2	2
<i>Telephone/e-mail</i>												
Mean (SD)	0	0	0	0	0	0	0	0	0	0.07 (0.37)	0.04 (0.2)	0
Minimum	0	0	0	0	0	0	0	0	0	0	0	0
Maximum	0	0	0	0	0	0	0	0	0	2	1	0
<i>Podiatrist</i>												
<i>Face to face</i>												
Mean (SD)	0.31 (0.76)	0.27 (0.83)	0.24 (0.72)	0.31 (0.76)	0.35 (1.02)	0.48 (0.96)	0.69 (1.83)	0.62 (1.3)	0.92 (2.56)	0.93 (1.98)	0.88 (1.86)	0.32 (1.22)
Minimum	0	0	0	0	0	0	0	0	0	0	0	0
Maximum	3	3	3	3	4	3	9	4	12	8	6	6

continued

**TABLE 79** Average resource use per patient in each trial arm<sup>a, b</sup> (continued)

Resource	Time point											
	12 weeks			24 weeks			36 weeks			48 weeks		
	Treatment arm											
	Rituximab (n = 29)	Abatacept (n = 26)	TNFi (n = 25)	Rituximab (n = 29)	Abatacept (n = 26)	TNFi (n = 25)	Rituximab (n = 29)	Abatacept (n = 26)	TNFi (n = 25)	Rituximab (n = 29)	Abatacept (n = 26)	TNFi (n = 25)
<b>Telephone/e-mail</b>												
Mean (SD)	0.07 (0.37)	0	0	0	0	0	0	0	0	0.21 (1.11)	0	0
Minimum	0	0	0	0	0	0	0	0	0	0	0	0
Maximum	2	0	0	0	0	0	0	0	0	6	0	0
<b>Counsellor</b>												
<b>Face to face</b>												
Mean (SD)	0	0	0	0.1 (0.56)	0	0.16 (0.8)	0.1 (0.56)	0	0.08 (0.4)	0.1 (0.56)	0	0
Minimum	0	0	0	0	0	0	0	0	0	0	0	0
Maximum	0	0	0	3	0	4	3	0	2	3	0	0
<b>Telephone/e-mail</b>												
Mean (SD)	0	0	0	0	0	0	0	0	0.16 (0.8)	0	0	0
Minimum	0	0	0	0	0	0	0	0	0	0	0	0
Maximum	0	0	0	0	0	0	0	0	4	0	0	0
<b>Psychologist</b>												
<b>Face to face</b>												
Mean (SD)	0	0	0	0	0	0	0.03 (0.19)	0	0	0.1 (0.56)	0	0
Minimum	0	0	0	0	0	0	0	0	0	0	0	0
Maximum	0	0	0	0	0	0	1	0	0	3	0	0

Resource	Time point											
	12 weeks			24 weeks			36 weeks			48 weeks		
	Treatment arm											
	Rituximab (n = 29)	Abatacept (n = 26)	TNFi (n = 25)	Rituximab (n = 29)	Abatacept (n = 26)	TNFi (n = 25)	Rituximab (n = 29)	Abatacept (n = 26)	TNFi (n = 25)	Rituximab (n = 29)	Abatacept (n = 26)	TNFi (n = 25)
<i>Home help<sup>c</sup></i>												
Face to face												
Mean (SD)	0.83 (3.09)	0.46 (2.35)	0	0.83 (3.09)	0	0.48 (2.4)	0.83 (3.09)	0	0	1.24 (3.72)	0	0
Minimum	0	0	0	0	0	0	0	0	0	0	0	0
Maximum	12	12	0	12	0	12	12	0	0	12	0	0
<i>Hospital or residential care service</i>												
Hospital inpatient stay												
Mean (SD)	0	0	0	0.21 (0.94)	0	0	0.59 (1.66)	0	0	0	0	0.08 (0.28)
Minimum	0	0	0	0	0	0	0	0	0	0	0	0
Maximum	0	0	0	5	0	0	6	0	0	0	0	1
Hospital outpatient clinic												
Mean (SD)	0.59 (1.02)	1.12 (1.24)	1.44 (2.75)	0.86 (1.03)	0.88 (1.03)	1.36 (0.95)	1.1 (1.11)	1.27 (1.04)	0.88 (0.97)	0.93 (1)	0.88 (0.95)	1.08 (1.04)
Minimum	0	0	0	0	0	0	0	0	0	0	0	0
Maximum	4	5	14	3	3	3	4	3	2	2	2	3
Hospital day centre												
Mean (SD)	0.45 (1.02)	0	0.12 (0.6)	0.17 (0.66)	0.23 (0.82)	0.12 (0.6)	0.48 (1.12)	0.31 (0.97)	0.4 (1.32)	0.66 (1.37)	0.54 (1.73)	0.56 (1.32)
Minimum	0	0	0	0	0	0	0	0	0	0	0	0
Maximum	3	0	3	3	3	3	4	4	6	5	8	4

continued

**TABLE 79** Average resource use per patient in each trial arm<sup>a, b</sup> (continued)

Resource	Time point											
	12 weeks			24 weeks			36 weeks			48 weeks		
	Treatment arm											
	Rituximab (n = 29)	Abatacept (n = 26)	TNFi (n = 25)	Rituximab (n = 29)	Abatacept (n = 26)	TNFi (n = 25)	Rituximab (n = 29)	Abatacept (n = 26)	TNFi (n = 25)	Rituximab (n = 29)	Abatacept (n = 26)	TNFi (n = 25)
Hospital accident and emergency department												
Mean (SD)	0	0.08 (0.39)	0.12 (0.6)	0.17 (0.54)	0.08 (0.39)	0.08 (0.4)	0.14 (0.58)	0.04 (0.2)	0	0.03 (0.19)	0	0.2 (0.58)
Minimum	0	0	0	0	0	0	0	0	0	0	0	0
Maximum	0	2	3	2	2	2	3	1	0	1	0	2

a For consistency in sample sizes, only the resource use of patients with no missing cost data is reported in this table.

b The table reports only the use of main services and, as there were no reported nursing home or residential home visits, these are excluded from the table.

c There were no reported household help or psychologist contacts by telephone or e-mail.

TABLE 80 Average health-care costs (£) by trial arm<sup>a</sup>

Health-care cost	Cost														
	Time point														
	12 weeks			24 weeks			36 weeks			48 weeks			Total costs		
	Treatment arm			Treatment arm			Treatment arm			Treatment arm			Treatment arm		
	Rituximab (n = 29)	Abatacept (n = 26)	TNFi (n = 25)	Rituximab (n = 29)	Abatacept (n = 26)	TNFi (n = 25)	Rituximab (n = 29)	Abatacept (n = 26)	TNFi (n = 25)	Rituximab (n = 29)	Abatacept (n = 26)	TNFi (n = 25)	Rituximab (n = 29)	Abatacept (n = 26)	TNFi (n = 25)
<b>Total community health and social services costs</b>															
Mean (SD)	148.36 (189.81)	126.36 (163.97)	81.79 (97.53)	190.07 (248.13)	95.56 (92.58)	154.59 (213.56)	240.88 (351.98)	214.09 (415.49)	191.57 (258.95)	347.86 (567.01)	165.19 (209.73)	129.85 (155.14)	927.17 (1238.6)	601.2 (553.7)	557.8 (513.42)
Minimum	0	0	0	0	0	0	0	0	0	0	0	0	0	0	0
Maximum	818.89	651.78	267	916	358.3	890.20	1297.63	2168	1003.56	2649.79	829.78	570.15	5291.57	2388	1818.23
<b>Total hospital and residential care service costs</b>															
Mean (SD)	175.48 (242.04)	188.12 (241.07)	267.04 (399.20)	254.35 (524.83)	222.49 (332.29)	199.04 (166.25)	454.93 (555.61)	230.42 (225.73)	192.92 (312.42)	227.93 (521.64)	221.58 (290.24)	298.78 (273.42)	1112.71 (1137.51)	862.61 (788.43)	957.78 (678.42)
Minimum	0	0	0	0	0	0	0	0	0	0	0	0	0	0	224
Maximum	999	972	1846	2802.21	1230	704	1901	743	1209	1024	1280	864	5039.21	3322	2523
<b>Trial medication costs (inclusive of drug administration cost)</b>															
Mean (SD)	3980.09 (376.03)	3966.37 (542.51)	2302.18 (377.75)	418.96 (1255.21)	2721.6 (1443.94)	1662.59 (864.53)	1675.83 (2029.94)	2535.51 (1611.71)	1625.14 (865.73)	578.56 (1443.18)	2361.05 (1710.67)	1349.28 (1003.26)	6633.49 (3197.01)	11584.52 (4733.65)	6939.19 (2679.69)
Minimum	2024.96	1407.6	902.28	0	0	0	0	0	0	0	0	0	2024.96	1407.6	902.28
Maximum	4049.92	4129.2	3415.5	4049.92	3628.8	2288.91	4049.92	3628.8	2288.91	4049.92	3628.8	2288.91	16199.68	15015.6	9353.64
<b>Other medication costs</b>															
MTX															
Mean (SD)	9.93 (2.1)	8.03 (1.65)	10.18 (2.52)	7.7 (1.49)	7.66 (1.8)	8.64 (1.39)	7.53 (2.38)	7.66 (1.36)	8.16 (1.83)	8.35 (1.57)	7.87 (2.02)	8.16 (1.55)	32.36 (5.27)	30.92 (3.42)	35.14 (3.09)
Minimum	2.4	2.4	7.2	4.8	2.4	4.8	2.4	4.8	4.8	7.2	2.4	4.8	14.4	21.6	31.2
Maximum	14.4	9.6	19.2	12	12	9.6	12	12	12	12	9.6	9.6	38.4	33.6	45.6
<b>Other concomitant medication<sup>b</sup></b>															
Mean (SD)	–	–	–	–	–	–	–	–	–	–	–	–	396.78 (1830.36)	519.51 (1168.58)	807.93 (1909.68)
Minimum	–	–	–	–	–	–	–	–	–	–	–	–	0	0	0
Maximum	–	–	–	–	–	–	–	–	–	–	–	–	9907.84	3590.59	7014.68

continued

**TABLE 80** Average health-care costs (£) by trial arm<sup>a</sup> (continued)

Health-care cost	Cost														
	Time point														
	12 weeks			24 weeks			36 weeks			48 weeks			Total costs		
	Treatment arm			Treatment arm			Treatment arm			Treatment arm			Treatment arm		
	Rituximab (n = 29)	Abatacept (n = 26)	TNFi (n = 25)	Rituximab (n = 29)	Abatacept (n = 26)	TNFi (n = 25)	Rituximab (n = 29)	Abatacept (n = 26)	TNFi (n = 25)	Rituximab (n = 29)	Abatacept (n = 26)	TNFi (n = 25)	Rituximab (n = 29)	Abatacept (n = 26)	TNFi (n = 25)
<b>Total NHS costs<sup>c</sup></b>															
Mean (SD)	4313.87 (378.37)	4288.88 (604.15)	2661.18 (565.53)	871.08 (1339.2)	3047.32 (1310.12)	2024.87 (939.16)	2379.18 (1897.29)	2987.68 (1628.37)	2017.8 (823.93)	1141.6 (1532.23)	2755.38 (1649.07)	1786.07 (909.02)	9102.51 (3375.77)	13598.77 (4092.09)	9297.84 (2007.36)
Minimum	2967.85	1766	999.88	7.2	2.4	137.23	7.2	248.8	7.2	7.2	231.2	9.6	4716.78	2690.88	1462.19
Maximum	5122.32	5198.8	4201	4466.12	4840	3268.8	4994.52	6028	3268	5410.78	4611.99	2857.06	18064.16	17661.2	12573.96
<b>Total societal costs</b>															
Mean (SD)	183.74 (361.21)	118.88 (265.37)	356.33 (1276.82)	246.76 (479.87)	65.63 (103.15)	310.14 (824.62)	211.71 (817.26)	136.05 (342.1)	176.93 (430.94)	447.95 (1676.83)	72.27 (105.59)	103.68 (171.63)	1081.66 (2020.47)	387.79 (655.19)	947.07 (2521.82)
Minimum	0	0	0	0	0	0	0	0	0	0	0	0	0	0	0
Maximum	1553.85	960	6428.5	1936.5	337.5	4102.5	4415	1592	2120	9015	440	600	9028.5	2552	12676
<b>Total all<sup>c</sup></b>															
Mean (SD)	4497.61 (565.02)	4407.76 (693.58)	3017.51 (1421.18)	1148.69 (1479.19)	3215.29 (1209.9)	2335 (1051.97)	2590.89 (2225.42)	3123.73 (1806.39)	2194.72 (873.79)	1589.55 (2149.22)	2827.65 (1674.5)	18889.75 (915.7)	10184.17 (3509.55)	13986.55 (4382.28)	10244.91 (3298.72)
Minimum	3058.45	1766	999.88	23.4	574.36	167.23	7.2	251	7.2	23.7	253.38	9.6	4874.25	2692.23	1462.19
Maximum	5963.07	5748.8	9211.1	5160.12	5147.48	4522.1	9073.41	7620	3659	9208.6	4794.68	3114.81	18292.16	20213.2	21882.63

a Only the resource use of patients with no missing cost data is reported in this table.

b As concomitant medications were recorded separately from the clinical assessments at the time points, only total costs are available.

c The totals presented for the time points do not include costs of concomitant medications. Costs of concomitant medications are included in the total for all time points.





A decorative graphic consisting of numerous thin, parallel green lines that curve from the left side of the page towards the right, creating a sense of movement and depth.

**EME  
HS&DR  
HTA  
PGfAR  
PHR**

Part of the NIHR Journals Library  
[www.journalslibrary.nihr.ac.uk](http://www.journalslibrary.nihr.ac.uk)

*This report presents independent research funded by the National Institute for Health Research (NIHR). The views expressed are those of the author(s) and not necessarily those of the NHS, the NIHR or the Department of Health*

***Published by the NIHR Journals Library***