



Deposited via The University of Leeds.

White Rose Research Online URL for this paper:

<https://eprints.whiterose.ac.uk/id/eprint/106694/>

Version: Accepted Version

Article:

Polansky, J and Wang, M (2017) Proper Orthogonal Decomposition as a technique for identifying two-phase flow pattern based on electrical impedance tomography. *Flow Measurement and Instrumentation*, 53 (Part A). pp. 126-132. ISSN: 0955-5986

<https://doi.org/10.1016/j.flowmeasinst.2016.10.004>

Crown Copyright © 2016 Published by Elsevier Ltd. Licensed under the Creative Commons Attribution-NonCommercial-NoDerivatives 4.0 International
<http://creativecommons.org/licenses/by-nc-nd/4.0/>

Reuse

Items deposited in White Rose Research Online are protected by copyright, with all rights reserved unless indicated otherwise. They may be downloaded and/or printed for private study, or other acts as permitted by national copyright laws. The publisher or other rights holders may allow further reproduction and re-use of the full text version. This is indicated by the licence information on the White Rose Research Online record for the item.

Takedown

If you consider content in White Rose Research Online to be in breach of UK law, please notify us by emailing eprints@whiterose.ac.uk including the URL of the record and the reason for the withdrawal request.

Proper Orthogonal Decomposition as a technique for identifying two-phase flow pattern based on Electrical Impedance Tomography

Jiri Polansky, Mi Wang

School of chemical and process engineering, University of Leeds, LS2 9JT, UK

Abstract

Collecting very large amount of data from experimental measurement is a common practice in almost every scientific domain. There is a great need to have specific techniques capable of extracting synthetic information, which is essential to understand and model the specific phenomena. The Proper Orthogonal Decomposition (POD) is one of the most powerful data-analysis methods for multivariate and nonlinear phenomena. Generally, POD is a procedure that takes a given collection of input experimental or numerical data and creates an orthogonal basis constituted by functions estimated as the solutions of an integral eigenvalue problem known as a Fredholm equation. By utilising POD to identify flow structure in horizontal pipeline, specially, for slag, plug and wavy stratified air-water flow regimes, this paper proposes a novel approach, in which POD technique extends the current evaluation procedure of electrical impedance tomography applied on air-water flow measurement [32]. This extension is provided by implementation of the POD as an identifier of typical horizontal multiphase flow regimes. The POD snapshot matrices are reconstructed for electrical tomography measurement domain and specific flow conditions. Direct POD method introduced by Lumley and Snapshot POD method introduced by Sirovich are applied. It is expected that this study may provide new knowledge on two phase flow dynamics in a horizontal pipeline and supportive information for further prediction of multiphase flow regime.

Email addresses: jiri.polansky@icloud.com (Jiri Polansky),
m.wang@leeds.ac.uk (Mi Wang)

Keywords: Proper orthogonal decomposition, Two-phase flow, Multiphase flow regime, Electrical Impedance Tomography, Electrical Capacitance Tomography

1. Introduction

1.1. Classification and applications

Considering a gas-liquid two phase flow [35], the liquid and gas are regarded as the continuous and dispersed phases respectively [7]. Gas-liquid flows are commonly observed in many industrial processes such as oil and gas [14, 33], chemical and pharmaceutical [10, 16, 19], transportation [20] and nuclear industries [11, 8]. The relative distribution of the gas and liquid phases can take many different configurations depending on the process conditions, such as the flow rates of the gas and liquid. The configuration of the gas and liquid phases is known as the flow regime [38]. The flow regime describes the pattern of the inner structure of the flow and important hydrodynamic features such as volume fraction, phase and velocity distributions. Two phase flow regimes are often determined subjectively using direct methods such as the eyeballing method, high speed photography method and the radial attenuation method [12]. Empirical flow regime maps such as the Baker chart [2, 34] are commonly used for approximate and rapid identification of the flow regime under specific operating conditions. However, due to their approximate and subjective nature these techniques are not able to identify the prevalent multiphase flow regime with the required degree of accuracy. Statistical analysis of the signal has also been used for identification of flow regimes [13].

1.2. Flow pattern prediction

The prediction of flow patterns for fully developed gas-liquid flows typically employ mechanistic models that use different pressure drop and void fraction estimation procedures for each flow pattern [17, 28]. Accurate prediction of heat transfer, void fraction and pressure drop in gas-liquid flow is important in the design and optimisation of the unit operations dealing with such systems [21]. Therefore different flow regimes require specific modelling equations to predict their respective transfer properties [4]. Hence in order to produce a reliable design for a multiphase system it is imperative to be able to accurately determine the prevalent flow regime. In the recognition of the

prevalent flow pattern one must consider the relative quantities of the phases and the topology of their interfaces [34]. In two phase flow many other flow regimes are possible such as; stratified flow, bubbly flow, slug flow, plug flow and annular flow among others. The flow regime that is active depends on a number of factors; the fluid transport and material properties, flow rates, flow direction (co-current or counter-current), the shape and size of the conduit and the orientation (horizontal or vertical) [22]. Considering the orientation of the flow, due to differences in the densities of the phases, vertical flow patterns are different to those obtained in horizontal flow. An intrinsic difference between the two orientations is that horizontal flow patterns are generally not axisymmetric. Because of this the measurement of gas/liquid multiphase flow in horizontal pipes is inherently more difficult than that in vertical pipes due to the flow regimes experienced in the former configuration. Therefore, this study focuses on horizontal gas-liquid flow in pipes.

1.3. Horizontal flow regimes

Typical flow regimes obtained in horizontal gas-liquid multiphase flows are stratified flow, wavy stratified flow, slug flow, plug flow, bubble flow and annular flow [41]. In the bubble flow regime the bubbles are located near the top of the pipe due to buoyancy effects. Increasing the superficial velocity of the gas will promote the coalescence of the bubbles resulting in plug flow. A further increase in the superficial gas velocity will cause the gas plugs to form a continuous layer of gas above liquid resulting in a smooth interface between the gas and liquid which is termed stratified flow. In this flow regime the gas will move at a higher velocity than the liquid due to the lower viscosity and density of the gas phase. Once again increasing the superficial velocity of the gas will increase the interfacial stress and create wave flow. A further increase in the gas flow rate will result in waves that are able to bridge the top of the pipe and hence produce large slugs of air in the top section of the pipe and this is known as slug flow. At extremely high superficial gas velocities annular flow is achieved whereby a thin liquid film flows along the pipe wall surrounding a centralised core of gas. A further increase in the gas flow rate will result in the formation of spray flow where the liquid phase is distributed as small droplets within the gas phase [19].

1.4. Flow dynamics structure identification

In order to better understand the fluid dynamic nature of Gas-liquid flows this paper focuses on flow regimes and pressure drop identification using

statistical approaches based on Proper Orthogonal decomposition. POD is used to identify the flow dynamics structure in the tomography dataset. Fundamentals of physical, mathematical and numerical models of horizontal flow regimes recognition are developed and presented. Developed statistical method exploits the fact that specific flow condition of specific gas and liquid phases thermophysical properties generate the unique and measurable flow instabilities. To recognise gas-liquid flow instabilities which is caused by different phase density, viscosity, surface tension and velocity, means indeed the recognition of the prevalent regime moreover indicates the actual flow conditions of the monitored area. POD techniques allow to disassemble the complex flow dynamics structures acquired via tomography technology to the fundamental dynamics structures.

2. Approach

The intention of developing a method for recognition of flow regime using decomposition mathematical technique comes from the fact that each regime is characterised by typical dynamic behaviour [24]. To recognise the flow dynamic structures, means indeed the recognition of the prevalent regime moreover indicates the actual flow conditions of the monitored area. The main aim of the present study is to develop a method of flow regime recognition, which is based on Proper orthogonal decomposition (POD) supplemented by Linear stochastic estimation (LSE) [1, 5]. Additionally, the basic functions determined by experimental investigation serve to the database and numerical model validation. The schematic diagram of the concept is illustrated in Figure 1 . The highlighted blocks in the scheme present the current state of the research and the contribution to the complex method. We recognise two fundamental modes of this procedure, the learning mode and flow evaluation mode. The learning mode consists of the following tasks:

1. Provide experimental multiphase flow measurement for specific flow conditions.
2. Electrical conductivity respectively electrical permittivity of mixture.
3. Mass flow rates, viscosity, pressure and temperature data acquisition.
4. Tomography images reconstruction.
5. POD analyses of tomography images, respectively RAW data.
6. Collect and store POD modes into POD database.
7. Analyse the POD modes from theoretical fluid dynamics point of view.

8. Frequency and statistical analysis, detection of various flow instability mechanisms.
9. Coupling of the results with POD modes and specific flow conditions.

With a sufficiently extensive POD database the developed method could be operate on the second, flow evaluation mode. This one is consist of the following tasks:

1. Provide multiphase flow measurement for unknown flow conditions.
2. Tomography data acquisition.
3. The thermo-physical fluid properties must be known or predicted (pressure, viscosity, temperature).
4. Concentration images reconstruction.
5. Concentration images, respectively unfiltered RAW data, POD analyses.
6. Actual POD modes comparing with POD database.
7. POD modes similarity recognition, flow instability identification.
8. Flow conditions, respectively flow patterns estimation.

2.1. Image reconstruction

The typical input data sets for POD fluid dynamics analysis are the Electrical resistivity tomography (ERT) or Electrical capacitance tomography (ECT) images of the phases concentration. The algorithms based on Modified Sensitivity Back Projection, implemented as a default algorithm of Industrial Tomography Systems (ITS) software, was used for the ERT concentration estimation of present study. The algorithms and techniques are introduced and described in the literature [42, 39].

2.2. Proper Orthogonal Decomposition

Proper Orthogonal Decomposition finds applications in computationally and experimental processing large amounts of high-dimensional data with the aim of obtaining low-dimensional descriptions [24, 37]. Using POD, time independent basis functions were extracted from the EIT data and were projected onto the basis functions to generate reduced-order models. In the reduced-order models (ROMs) [6, 15] the large amount of experimental data are replaced by a much smaller number of coefficients of ordinary differential equations. These reduced-order models were applied to several reference cases; Liquid mass flow rate between $1 - 1000 \text{ kg/sm}^2$, gas mass flow rate

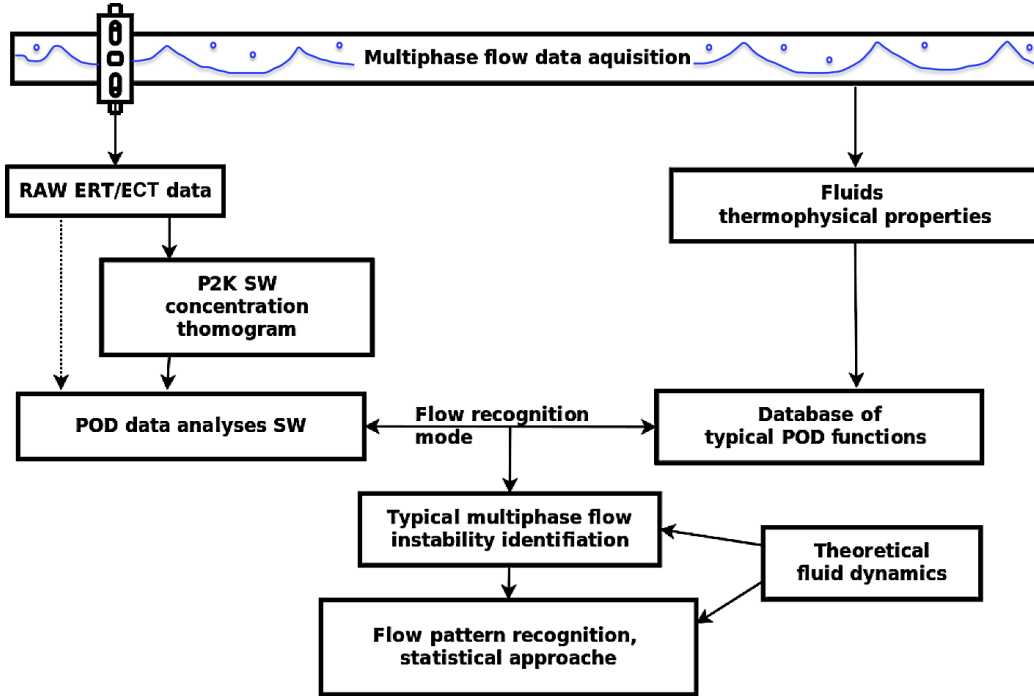

Figure 1: Scheme of Flow pattern recognition based on POD analyses

between $0.1 - 20 \text{ kg/sm}^2$ simulating on water-air experimental loop, using the fast impedance camera system (FICA) [32].

From a mathematical point of view, the Proper Orthogonal Decomposition is a transformation with a diagonal matrix $U(x, t)$ and brings it to a canonical form. The mathematical concept of POD is based on the spectral theory of compact, self adjoints operations [9]. The vector-value function approximation, the conductivity or concentration in this study, over domain of interest, is supposed as a finite sum in the variables-separated form (1):

$$U(x, t) = \sum_{m=1}^M a_m(x)\phi_m(t). \quad (1)$$

$U(x, t)$ in the equation (1) is given fluctuating field of concentration, pressure or velocity, a_m is time-independent POD base function and ϕ_m is vector of space-independent coefficients in the m mode.

POD decomposes a given fluctuating flow field $U(x, t)$ into an orthonormal system of spatial modes $a_m(x)$ and corresponding orthogonal temporal

coefficients $\phi_m(t)$. This basis is optimal in the sense that a truncated series expansion of the data in this basis has a smaller mean square truncation error than a representation by any other basis. The POD provides a natural ordering of the spatial modes by measure of their mean square temporal amplitude, such as kinetic energy in the case of velocity field [26]. In conjunction with the Galerkin method a system of ordinary differential equations, called the Galerkin system, can be derived for the temporal evolution of the temporal amplitudes.

Considering dimension of the tomography data matrix, the experimental data preferable uses direct POD approach, which is developed by Lumley [25]. In this case the average is temporal and evaluated as an ensemble average, based on the assumptions of stationary and ergodicity. On the other hand, the variable $U(x, t)$ is assimilated to the space variable $x = (x, y, z)$ defined over the domain of interest (two measurement EIT planes consist of the 360 cells). In order to estimate the set of POD basis functions, Python parallel library MODRED [3] is used. The fundamental characteristics of the calculation procedure are as follow:

- Collect, order and store the concentration vectors $U(x, t) = [u_i(x)]$, for each frame of data acquisition $i = 1, \dots, i_t$.
- Compute each entry of the $i_t \times i_t$ correlation matrix H via $[H]_{i,j} = \langle u_i, u_j \rangle$.
- Compute the eigenvalues and eigenvectors of correlation matrix, writing $HX = X\Sigma$, where eigenvalues Σ is diagonal and real, eigenvector X is orthogonal, since H is symmetric.
- Sort the eigenvalues and corresponding eigenvectors in descending order.
- Select the number of modes M , truncate the matrices, keeping the first M columns of X to obtain X_M , and the first M rows and columns of Σ to obtain Σ_M .
- Compute the matrix of modes $A = X_M \Sigma_M^{-1/2}$.
- Construct corresponding temporal coefficients ϕ individually via (2)

$$\phi_m(t) = \sum_{i=1}^{i_t} u_i(x)[A]_{i,m}^T, \quad m = 1, \dots, M. \quad (2)$$

ϕ_m in the equation (2) is temporal POD coefficients of the m mode, u_i is the temporal component of fluctuating field of concentration vector $U(x, t)$ of i frame and A is the vector of time-independent POD function.

The different number of modes is tested, $M \in (3 - 20)$. The reconstructed image shows the dominant role of the first few modes. POD can be applied for flow regime recognition using reduced number of modes (3 modes), unlike the identification of fluid dynamics behaviour, in which higher number of modes is required.

2.2.1. Direct versus Snapshot approach

The fundamental questions of the POD approach choice are: the input data collection, the inner product, the averaging operation (spatial or temporal) and the variable \vec{X} (spatial $\vec{x} = (x, y, z)$ or temporal t).

Schematic view of Direct and Snapshot approaches application for process tomography data are shown on the Figure 2. In Classical direct method, the average operator $\langle * \rangle$ is temporal. The snapshot POD method, which is developed by Sirovich [31], is exact symmetry of the classical POD. The average operator $\langle * \rangle$ is evaluated as a space average over the domain of interest.

The snapshot approached is tested for experimental multiphase flow data as an alternative POD method, however the snapshot approach is more suitable for data of numerical investigation with regard to the typical correlation matrix size.

2.3. Repeatability of developed approach

POD base functions database is developed for the specific device configuration and flow conditions. The function database should be used for pattern estimation exclusively inside the known flow conditions area. Tomography device settings and configuration, such as sample frequency, geometry and number of electrodes, type of resistance network, algorithm of image reconstruction should correspond with reference measurements.

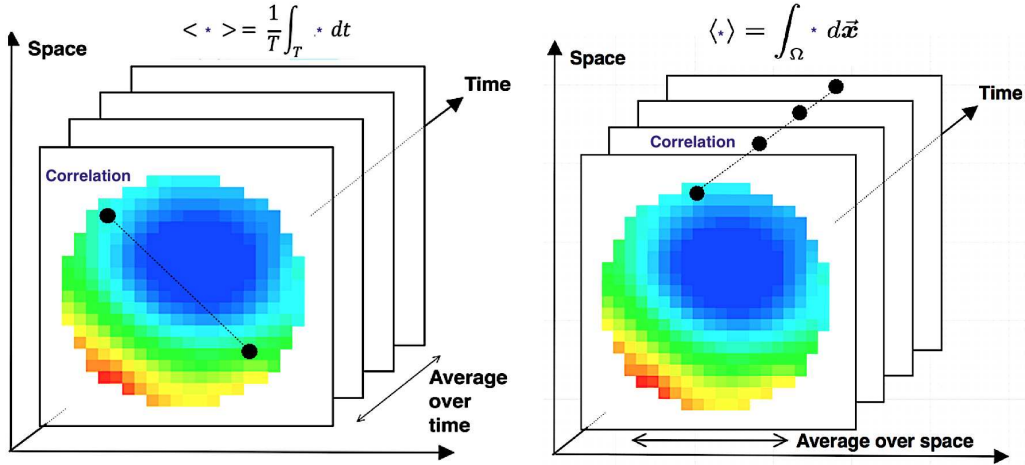

Figure 2: Schematic view of Direct (left) and Snapshot (right) POD approaches

The POD approach is basically incapable to recognise caution of flow instabilities itself. The POD algorithm decompose the signal and order the function according the actual relevance of dynamics structures. The flow instabilities caused by different mechanics change the importance for different flow conditions. It means, the same mechanism could occupy the different base functions position and must be recognised manually by experimentalist. This additional information accompanies the function database and it is unique for given flow condition area.

2.4. Liquid-gas flow test rig

The experiments were carried out in a flow loop built at the University of Leeds with a 3.0 m long, 50 mm internal diameter, transparent, vertical and horizontal working section, which is shown in Figure 3. Air was introduced into the base of the working section via a central tube inside a Y tee. A thermometer was used to provide continuous monitoring of the water temperature. Two differential pressure sensors for measuring the differential pressure drop were placed along the column at around 2.5 m above the air distributor. The water volumetric flow rate Q_w , varying from 0 to $1.94 \times 10^3 \text{ m}^3/\text{s}$ and the air volumetric flow rate Q_a , varying from 0 to $1.67 \times 10^4 \text{ m}^3/\text{s}$ were measured separately through a turbine flowmeter and a gas flow controller before they were mixed together. An EIT sensor with 16 electrodes was mounted in the inner wall of the column. The electrodes

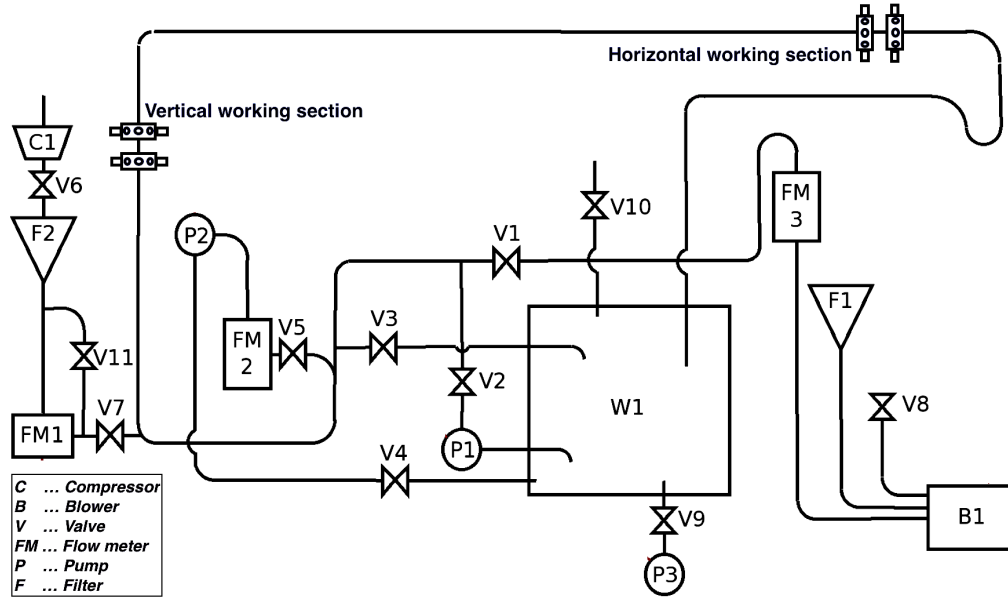

Figure 3: Liquid (water) - gas (air) experimental flow loop

were made of stainless steel with a contact area of 8 mm (width) by 16 mm (height). The data collection rate was 800 frames/s with an excitation signal frequency of $10.0kHz$.

2.5. Measurement matrix

The present POD method is tested via EIT and ECT data sets of horizontal and vertical pipeline orientation, two or three phase flow. The measurement points used for present study are shown on the Figure 4. The flow map shows 10 variants of horizontal water-air flow configuration covered the Plug, Slug and Stratified flow regimes, see Figure 5, stacked concentration tomogram on centerline cross-section of 2 inch pipeline.

3. Result and discussion

3.1. Results

Different flow regimes can be characterised through different structure of flow dynamics. In other words, each mode of POD can be used to represent the prevalent flow regime within the pipeline, as shown in Figure 6. The estimation of the first dominant basic functions enables, with certain

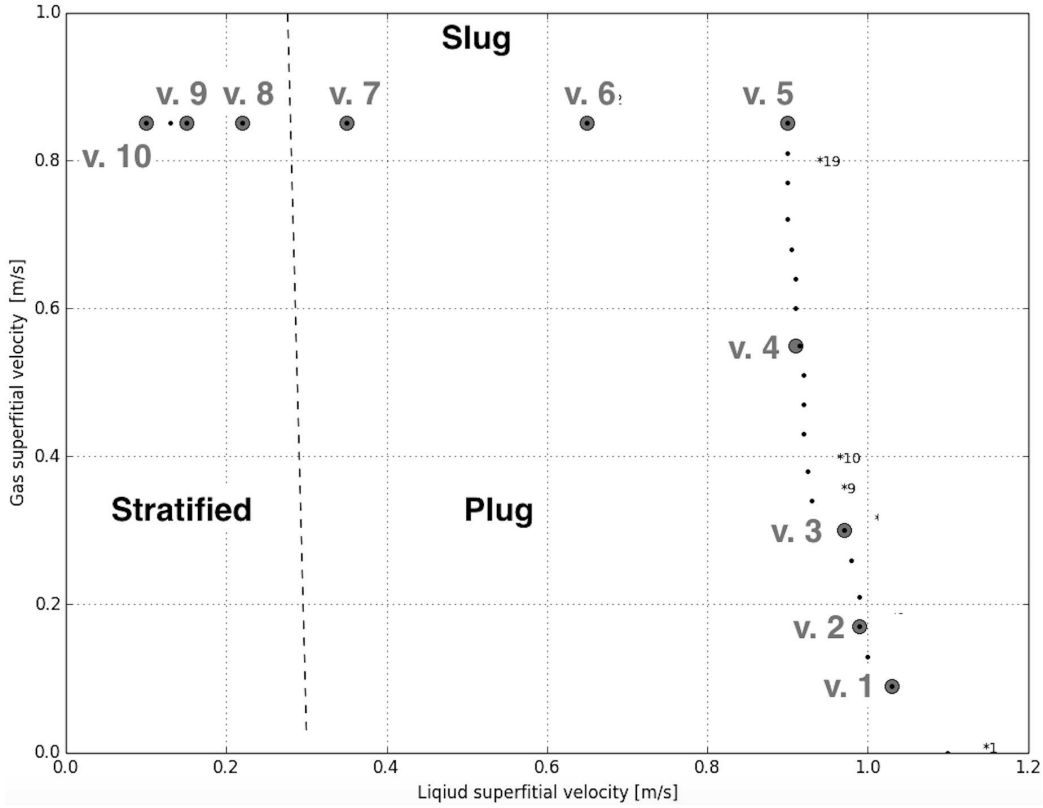

Figure 4: Measurement points

probability, the recognition of the flow regime based on the acquired signal from multiphase flow measurement. Figure 7 shows the comparison between the flow image reconstructed using EIT with that of POD. The EIT-based reconstructed image is shown in terms of stacked concentration tomogram. It is quite apparent that, the EIT technique can be utilised for validation of the results generated from the POD.

Figure 6 demonstrate the extraction of flow information which characterise the EIT signal from dynamics point of view, and Figure 7 illustrate the capability of original image reconstruction according extracted basis function, with certain accuracy . Both attributes of POD techniques will be utilised for further flow regime recognition based on the developed reduce-order model [6, 37].

It is obvious, the first POD mode and the corresponding time function

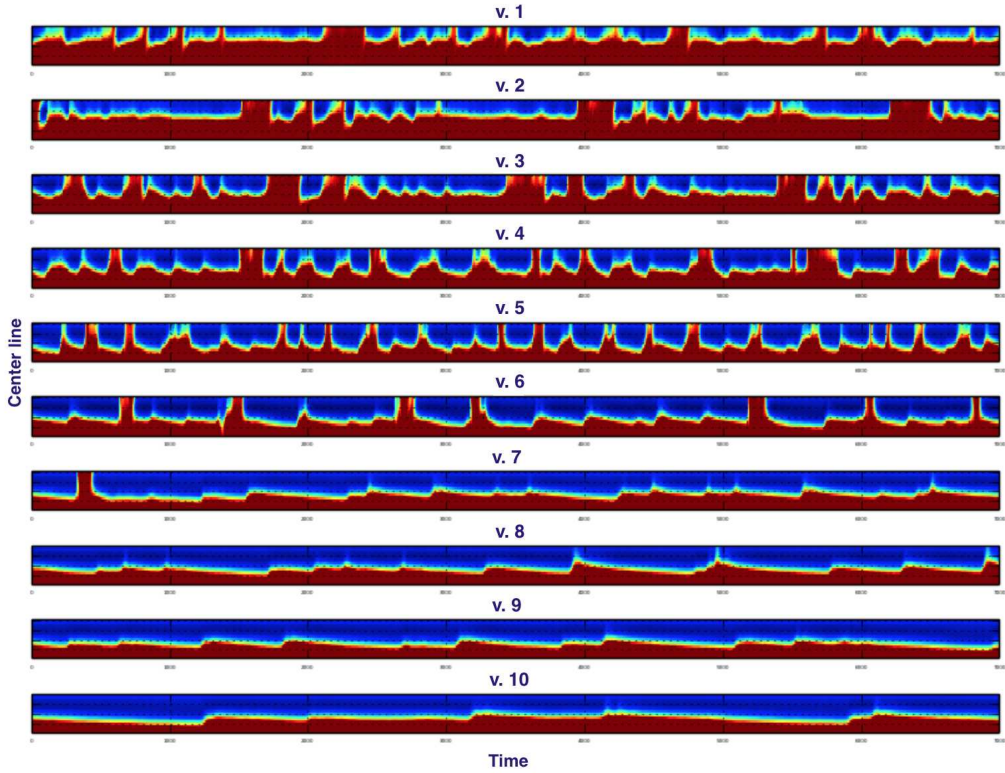

Figure 5: Stacked concentration tomogram, red = water, blue = air.

in terms of dynamic behaviour is dominant for the most of multiphase flow regimes, see Figure 8, first three modes of time function ϕ . However, for the flow pattern recognition is eligible to analyse more than first mode, because different modes seems to be the carrier of different scale of flow instabilities generated by the various physical mechanisms. Especially the frequency analysis of the time functions allow us to identify the different flow instabilities which are recognised and record by the EIT measurement and decomposed by the POD analysis. The POD provides the study of instability on the different temporal and spatial scales. Another techniques capable to analyse the experimental data sets, especially time variable signal, from dynamics point of view is wavelet transformation [15].

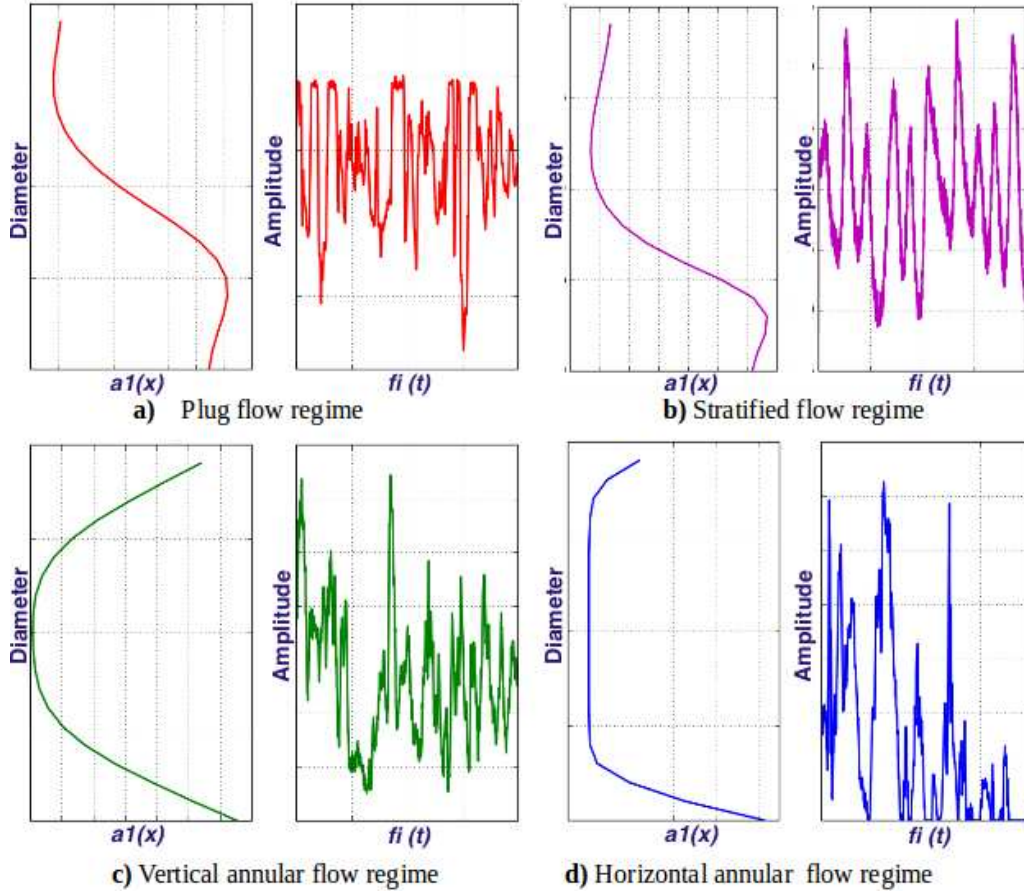

Figure 6: Normalised POD Basis functions of specific flow regimes, 1 mode

3.2. Conditions and limits of the POD method

There are two basic characteristics of a flow pattern, the degree of separation of different concentrations and level of intermittency in the volume fraction. Both important parameters could be determined by using a different approaches to analyse the tomography data, such as a Neural network [23], Boolean logic analysis [29], stochastic flow modelling [30] and many others. The presented methods is based on the recognition of the typical dynamic coherent structures in the fluid mixture. The sufficient time and spatial resolution of the measurement method is one of the fundamentals prerequisite for successful specific flow instabilities recognition. The typical frequency of multiphase flow instabilities must be predicted before data ac-

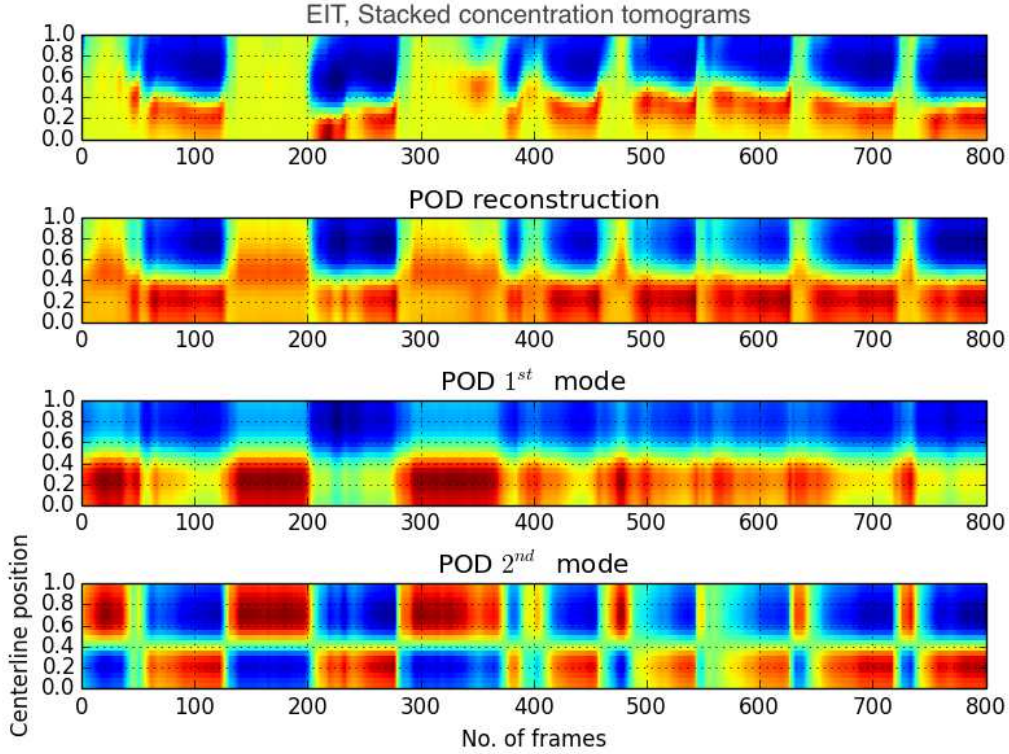

Figure 7: Comparison of the POD-based reconstructed image with that of the EIT for horizontal plug flow

quisition and that fact affects the choice of the sampling frequency. Used Fast impedance camera system with the frequency up to 1 kHz could be sufficient for superficial gas and liquid velocity up to 20 m/s.

3.3. Error analyses

The accuracy of POD reconstruction is strongly depends on the number of POD modes and flow conditions. The comparison of relative and absolute error for 3 and 4 modes reconstruction are shown on the Figure 9. The errors are calculated for 8000 frames (10s data acquisition). It is obvious, the reconstruction involving the fourth POD mode causes the reduction of the errors on the half, approximately. The accuracy of the measured signal reconstruction relates to the capability to use POD for data filtering and compressing as well as an order of multiphase flow model reducing.

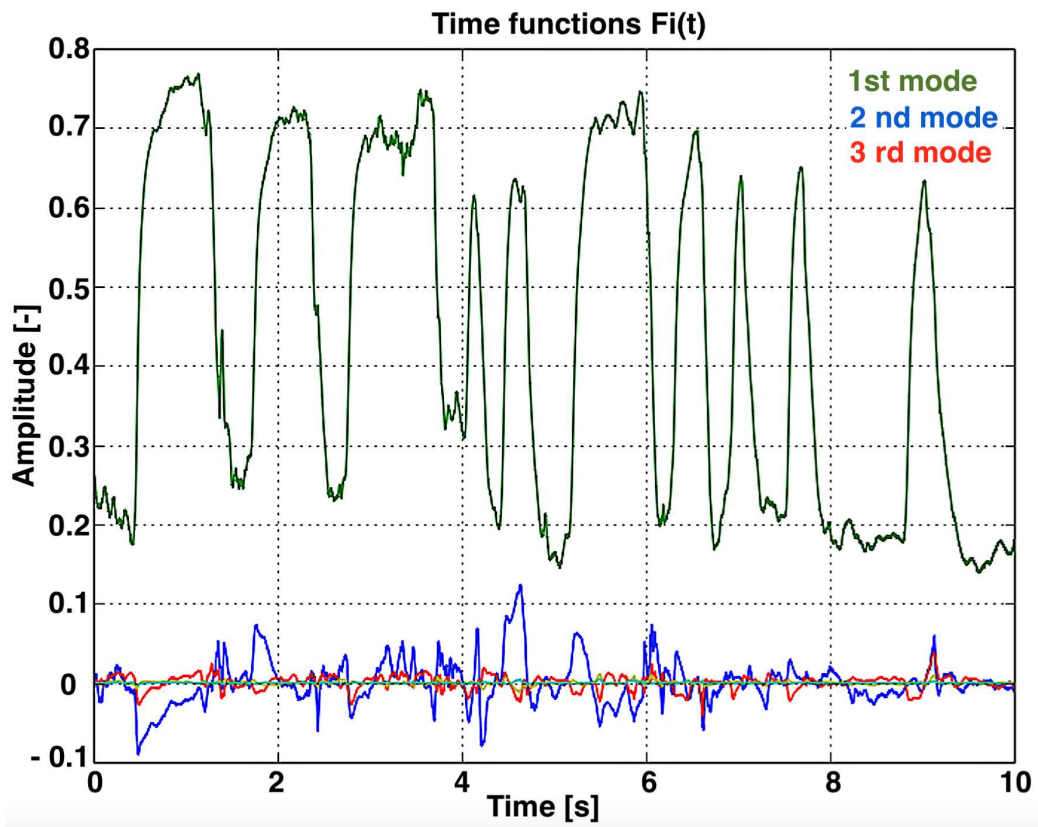

Figure 8: Normalised space independent functions $\phi(t)$ of horizontal Slug flow regime, comparison of first three modes

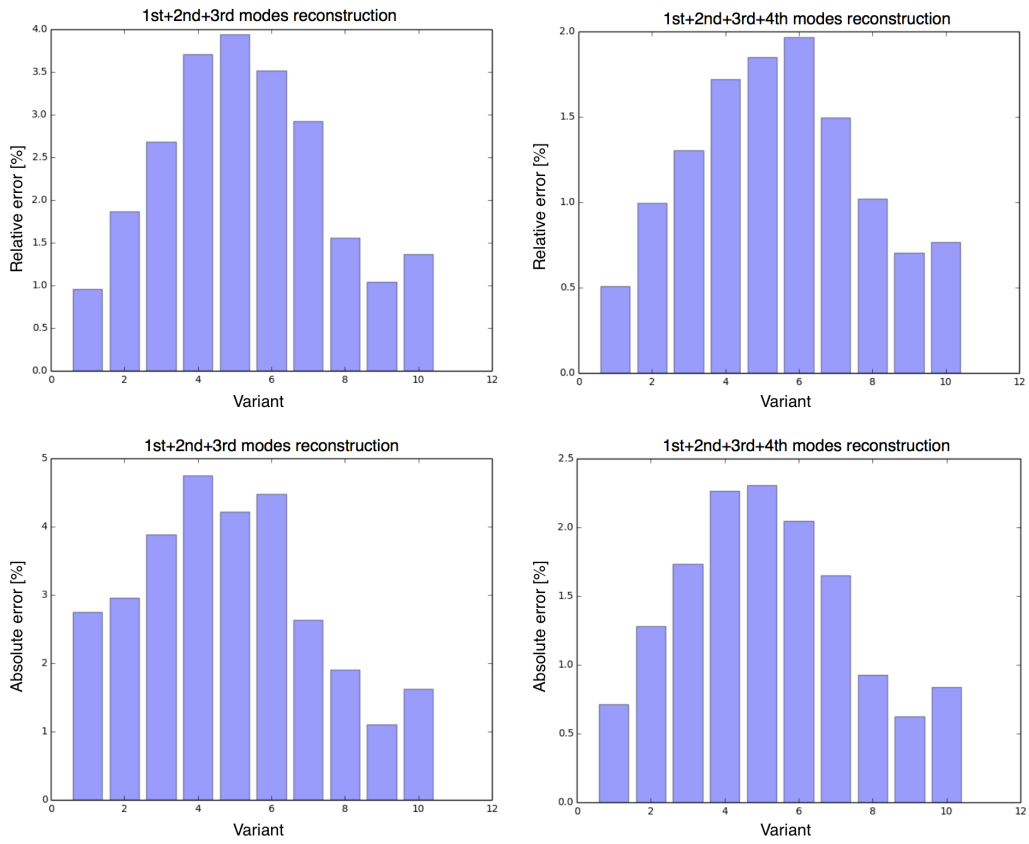

Figure 9: Relative and absolute error analyses of POD data reconstruction, left: the first three modes, right: the first four modes

4. Conclusions

Two-phase gas-liquid flow regime recognition using any decomposition technique could be promising methods for EIT data post-processing. The proposed method is based on typical fluid dynamic structure and instability recognition on the flow measurement, which is based on POD. The application of the method is based upon the database of typical basis functions. The database could be developed by multiphase flow experimental and numerical modelling and implementing the theory of multiphase flow instability [40]. The proposed method could be used to validate the numerical models based on Large eddied simulation or Direct simulation approaches [36]. Also, to test and validate the established databases of typical basis functions for horizontal gas-liquid flow, reported elsewhere [27].

A part of the present procedure is signal filtering of the electronic devices noise and noise induced by electrical tomography signal reconstruction algorithm. In principle, this filtering could be as part of the POD methods. However, this can work quite well if the estimated different POD modes are assigned for different types of dynamic behaviour. In other words, i.e. the external noise is clearly distinguished from fluid dynamics phenomena, otherwise, the filtering has to be performed separately from POD.

The accuracy of flow regime identification is depends on the frequency of the data obtained from the of electrical tomography systems. This implies that, the flow regime recognition can not be carried out on-line according to the principle of the statistical decomposition techniques. The speed of flow regime recognition depends on the number of frames acquired from the tomography system, and this number of the frames should take into account all flow dynamic features related to the active flow regime. Nevertheless, the method returns the preliminary information on regime identification, and the higher the number of frames is, the more accurate identification of the regime can be achieved. Further increase the number of measured frames will apparently increase the time length of POD evaluation.

The different POD approaches, direct versus Snapshot method, optimal time of evaluating record, total number of evaluated POD mode, optimal size of snapshot matrix, the number of modes used for estimation process, signal filtering, and dependencies of estimation accuracy of all mentioned parameters, is the subject of the present and complex future study.

5. Acknowledgement

This research was supported by European Association of National Metrology Institutes, project ENG58, Multiphase flow metrology in oil and gas production.

6. References

- [1] Adrian R.J., On the role of conditional averages in turbulence theory, In J. L. Zakin & G. K. Patterson, editor, *Turbulence in Liquids*, pp. 323-332, 1977
- [2] Baker D., Simultaneous Flow of Oil and Gas, *Oil and Gas J*, 53, pp 183-195., 1954
- [3] Belson B.A., TU J.H., Rowley C.W., *A parallelized model reduction library*, Princeton University, 2013
- [4] Bertola V, *Modelling and experimentation in Two-Phase Flow*, Springer-Verlag Wien New York in 2003, ISBN 978-3-211-20757-4, ISBN 978-3-7091-2538-0 (eBook) DOI 10.1007/978-3-7091-2538-0
- [5] Bonnet J.P., Cole D.R., *Stochastic Estimation and proper orthogonal decomposition: Complementary techniques for identifying structure*, *Experiments in Fluid* 17, 1994
- [6] Brenner T.A., *Practical Aspects of the Implementation of Reduced-Order Models Based on Proper Orthogonal Decomposition* Texas A&M University, PhD theses, 2011
- [7] Brenner C.E., *Fundamentals of Multiphase Flows*, California Institute of Technology Pasadena, Cambridge University Press, ISBN 0521 848040, 2005
- [8] Coppolani P., Hassenboehler N., Joseph J., *La chaudiere des reacteurs a eau sous pression*, ISBN: 2-86883-741-7 Paris, 2004
- [9] Courant R., Hilbert D., *Methods of mathematical physics, Vol. 1* John Wiley & Sons, New-Yourk, 1953
- [10] Cora J., Ordonez S. Diaz E., *Mass Transfer Operations: Absorption And Extraction*, *Encyclopedia of Life Support Systems*

- [11] Delhayé J.M., Thermohydraulique des reacteurs, ISBN 13: 9782759810949, Paris, 2008
- [12] Deng, X, et al. (2001), The design of a dual plane ERT system for cross correlation measurement of bubbly gas/liquid flow. Measurement Science and Technology. 2001, Vol. 12, pp. 1024-1031.
- [13] Faray, Y., Wang, M. Jai, J., Automated horizontal slurry flow regime recognition using statistical analysis of the ERT signal. Journal of Procedia Engineering. 102, pp. 821-830, 2015
- [14] Freese T. L.& Associates, Inc., The Transportation of Petroleum and Derived Products in the American Market, 2006
- [15] Gordeyev S., POD,LSE and Wavelet decomposition: Literature Review, University of Notre dame
- [16] Halvorsn I.J., Skogestad S., Distillation Theory, Norwegian University of Science and Technology, 2000
- [17] Hewitt G.F., Roberyson D.N., Studies of Two-Phase Flow Patterns by Simultaneous X- ray and Flash Photography, Rept AERE-M2159, UKAEA, Harwell., 1969
- [18] Hewitt G.F., Empirical and Phenomenological Models for Multiphase Flows II. Horizontal Flows, Department of Chemical Engineering Imperial College London, UK, 2015
- [19] Holland, F A, Bragg, R., Fluid Flow for Chemical Engineers. London : Edward Arnold, 1995. pp. 219-267., 1995
- [20] Energy, transport and environment indicators, Eurostat, ISBN 978-92-79-41256-1, 2014
- [21] Jassim E.W., Newell T.A., CHato J.C., Probabilistic Flow Regime Map Modelling of Two- phase flow. Illinois : University of Illinois, pp. 1-6., 2006
- [22] Kleinstreuer C., Two-Phase Flow: Theory and Application. New York : Taylor and Francis, pp. 69-75., 2003

- [23] Khursiah Z.-M., Junita M.-S., Hafizah T., Najwan O.-A., Flow Regime Classification Using Artificial Neural Network Trained on Electrical Capacitance Tomography Sensor Data, *Computer and Information Science* ISSN 1913-8989, Vol.1, No.1, 2008
- [24] Laurent C., Bergman M., Post-processing of experimental and numerical data, POD: an overview, von Karman Institute for Fluid Dynamics, Lecture Series, 2003
- [25] Lumley J. L. The structure of inhomogeneous turbulent flows. In *Atmospheric Turbulence and Radio Wave Propagation* (ed. A. M. Yaglom & V. I. Tartarsky), p. 166. Nauka, Moscow. 1967
- [26] Luchtenburg D.M., Noack B.R., Schlegel M., An introduction to the POD Galerkin method for fluid flows with analytical examples and MATLAB source codes, Berlin Institute of Technology, Technical Report 01/2009
- [27] Polansky J., Wang M., Faray Y., Numerical modelling of gas-liquid flow phenomena in horizontal pipelines, 12th International Symposium on Experimental Computational Aerothermodynamics of Internal Flows, 2015, Genova, Italy
- [28] Prasser H.M. , Basic model for two-phase flows, Swiss Federal Institute of Technology, Zurich, 2015
- [29] Ramskill P.N., Wang M., Boolean logic analysis for flow regime recognition of gasliquid horizontal flow, *Measurement Science and Technology*, Vol. 22, No. 10, , 2011
- [30] Sankowski D. , Mosorov V., Grudzien K., Mass flow measurements based on a virtual channel concept, ISSN 2164-7143, pp.274 - 279, 5th International Conference on Intelligent Systems Design and Applications, 2005
- [31] Sirovich L., Turbulence and the dynamics of coherent structures, *Quarterly of Applied Mathematics* XLV, No.3., pp.561-571, 1987
- [32] Ramskill N.P.; Wang M. , Measurement and recognition of gas-liquid multiphase horizontal flow regimes using electrical resistance tomography in: 6th World Congress in Industrial Process Tomography, pp.159-167. International Society for Industrial Process Tomography,2010

- [33] Takacs G., Gas Lift Handbook, ISBN-10: 0878148051, 2004
- [34] Tilton, Jason N., Fluid and Particle Dynamics. [book auth.] Robert H Perry and Don W Green. Perry's Chemical Engineers' Handbook - 8th Edition. New York : McGraw Hill, 2008
- [35] Thomas J. Handratty, Physics of Gas-Liquid Flows, University of Illinois at Urbana-Champaign, ISBN 978-1-107-04120-2, 2013
- [36] Triggvason G., Scardavelli R. , Zaleski S., Direct Numerical Simulations of Gas Liquid Multiphase Flows, The volume-of-fluid method pp. 95-132, ISBN:9780511975264, 2005
- [37] Volkwein, Proper Orthogonal Decomposition: Theory and Reduced-Order Modelling, University of Konstanz, lecture note, 2013
- [38] Wallis G.B., One-dimensional Two-phase Flow. New York : McGraw Hill. p. Chapter 1., 1969
- [39] Wang M., Industrial Tomography, Systems and Applications, ISBN 978-1-78242-123-8, Elsevier 2015
- [40] Yadigaroglu G., Instabilities in two-phase flow, Swiss Federal Institute of Technology, Zurich, 2015
- [41] Yixin M., Zhichu Z., Ling-an X., Xiaoping L., Yingxiang W., Application of electrical resistance tomography system to monitor gas/liquid two-phase flow in a horizontal pipe. Flow Measurement and Instrumentation. 2001, Vol. 12, pp. 259-265.
- [42] Yang W. Q., Lihui Peng Image reconstruction algorithms for electrical capacitance tomography, Measurement Science and Technology, 0957-0233-14-1-201, 2003