



Deposited via The University of York.

White Rose Research Online URL for this paper:

<https://eprints.whiterose.ac.uk/id/eprint/125520/>

Version: Accepted Version

Article:

Cording, Amy, Shiaelis, Nicolas, Petridi, Stavroula et al. (2017) Targeted kinase inhibition relieves slowness and tremor in a Drosophila model of LRRK2 Parkinson's disease. npj Parkinson's Disease. ISSN: 2373-8057

<https://doi.org/10.1038/s41531-017-0036-y>

Reuse

Items deposited in White Rose Research Online are protected by copyright, with all rights reserved unless indicated otherwise. They may be downloaded and/or printed for private study, or other acts as permitted by national copyright laws. The publisher or other rights holders may allow further reproduction and re-use of the full text version. This is indicated by the licence information on the White Rose Research Online record for the item.

Takedown

If you consider content in White Rose Research Online to be in breach of UK law, please notify us by emailing eprints@whiterose.ac.uk including the URL of the record and the reason for the withdrawal request.

npj Parkinson's Disease**Disease models: A reflex reaction**

A simple reflex in flies can be used to test the effectiveness of therapies that slow neurodegeneration in Parkinson's disease (PD). Christopher Elliott and colleagues at the University of York in the United Kingdom investigated the contraction of the proboscis muscle which mediates a taste behavior response and is regulated by a single dopaminergic neuron. Flies bearing particular mutations in the PD-associated gene leucine-rich repeat kinase 2 (LRRK2) in dopaminergic neurons lost their ability to feed on a sweet solution. This was due to the movement of the proboscis muscle becoming slower and stiffer, hallmark features of PD. The authors rescued the impaired reflex reaction by feeding the flies L-dopa or LRRK2 inhibitors. These findings highlight the proboscis extension response as a useful tool to identify other PD-associated mutations and test potential therapeutic compounds.

Related Article Manuscript number: NPJPARKD-00105R

Manuscript title: Targeted kinase inhibition relieves slowness and tremor in a *Drosophila* model of LRRK2 Parkinson's.

Author and affiliation/ s: Dr Christopher Elliott, University of York, United Kingdom

About your Editorial Summary — please read

Before approving this Editorial Summary, please carefully check that (1) the summary text lists the correct author(s) and (2) the spelling and order of all author names and affiliations are correct.

This **Editorial Summary** is based on your manuscript that was recently accepted for publication in *npj Parkinson's Disease*. It provides a non-specialist audience with a synopsis of your key research outcomes and conclusions. This value-added service provided by NPG is designed to raise interest in your research across the broader community.

NPG will publish the summary on the journal's website, and it will be freely available under a Creative Commons "by-nd-nc 4.0 unported" license (see the journal website for details). We encourage you to re-use the summary to bring attention to your research; for example, you can host it on your own website and share it via social-networking platforms. Please attribute the summary to *npj Parkinson's Disease* and your article (e.g. by providing a link to your article) and do not make derivatives.

Please note that to maximise the usefulness of these summaries they must follow several stringent guidelines:

- Spelling, punctuation and style are set according to Nature Partner Journals editorial guidelines. As this summary is aimed at non-expert readers, some concepts and technical terms will be simplified.
- Total length must be no more than 135 words. It is likely that not all points in the paper will be covered.
- The first sentence must be no more than 140 characters, including spaces, to allow use on microblogging sites.
- The headline must consist of a brief generic subject identifier followed by a short description. No more than 10 words in total.

Please contact the editorial office (npjparkd@nature.com) immediately with corrections should you find any factual errors in this Editorial Summary.

Targeted kinase inhibition relieves slowness and tremor in a *Drosophila* model of LRRK2 Parkinson's disease.

Amy C. Cording⁽¹⁾, Nicolas Shiaelis⁽¹⁾, Stavroula Petridi⁽¹⁾, C. Adam Middleton⁽¹⁾, Laurence Wilson⁽²⁾ & Christopher J. H. Elliott ^{(1)*}

* To whom correspondence should be addressed

1) Department of Biology, University of York, York, YO1 5DD, UK

2) Department of Physics, University of York, York, YO1 5DD, UK

tel: 01904 328654

email: cje2@york.ac.uk

Abstract

In a number of *Drosophila* models of genetic Parkinson's Disease (PD) flies climb more slowly than wild-type controls. However, this assay does not distinguish effects of PD related genes on gravity sensation, 'arousal', central pattern generation of leg movements or muscle. To address this problem, we have developed an assay for the fly proboscis extension response (PER). This is attractive because the PER has a simple, well-identified reflex neural circuit, in which sucrose sensing neurons, activate a pair of 'command interneurons', and thence motoneurons whose activity contracts the proboscis muscle. This circuit is modulated by a single dopaminergic neuron (TH-VUM).

We find that expressing either the *G2019S* or *I2020T* (but not *R1441C*, or kinase dead) forms of human *LRRK2* in dopaminergic neurons reduces the percentage of flies that initially respond to sucrose stimulation. This is rescued fully by feeding L-DOPA and partially by feeding kinase inhibitors, targeted to *LRRK2* (*LRRK2-IN-1* and *BMPPB-32*). High-speed video shows that *G2019S* expression in dopaminergic neurons slows the speed of proboscis extension, makes its duration more variable, and increases the tremor. Testing subsets of dopaminergic neurons suggests that the single TH-VUM neuron is likely most important in this phenotype.

We conclude the *Drosophila* PER provides an excellent model of *LRRK2* motor deficits showing bradykinesia, akinesia, hypokinesia and increased tremor, with the possibility to localise changes in neural signalling.

Introduction

Parkinson's Disease is a progressive neurodegenerative condition characterised by pathological loss of dopaminergic neurons in the *substantia nigra*. The reduction in dopamine in the projections to the striatum leads to a range of motor disorders, characterised by bradykinesia (slower movements), hypokinesia (a reduction in the amplitude of movements) akinesia (absence of movement altogether) and tremor.

Although the cause of the majority of Parkinson's disease is unknown, a small proportion is inherited (see, for review, Singleton et al., 2013) with the most common genetic form being due to mutations in *LRRK2* (*Leucine Rich Repeat Kinase 2*).

This gene is translated into a large, multi-domain protein, and the pathogenic mutations include *G2019S* and *I2020T*², in which the kinase activity is increased³, and *R1441C*, a mutation in which the GTPase activity is thought to be reduced⁴.

The excellent genetic toolkit provided by *Drosophila* led to the creation of fly models of Parkinson's disease. These reflect many features of the disease (loss of dopaminergic neurons, reduced movement, mitochondrial abnormalities, oxidative stress and visual deficits^{5,6}). Many labs have adopted the fly negative geotaxis assay (sometimes called the 'startle response assay') as their measure of movement⁷⁻⁹. In this, the speed at which flies walk up a glass cylinder in response to a sharp tap is recorded. Although PD-mimic flies have reduced movement, it is hard to specify exactly where the changes are taking place (response to the startle stimulus or gravity, or effects on the central pattern generator or motor neurons or changes directly affecting the leg muscles themselves). This assay also fails to discriminate between the different possible movement defects (akinesia, hypokinesia and bradykinesia). We suggest the requirement for another, simpler assay system.

This is reinforced by the difficulty of determining which of the ~125 dopaminergic neurons in the fly CNS^{10,11}, are important in the negative geotaxis response. Although dopaminergic innervation of the mushroom body by 15 'PAM' neurons plays a major role in this negative geotaxis response¹², the subsequent neuronal pathway is unclear. Further, manipulations of PD-related transgenes often lead to the loss of a relatively small proportion of dopaminergic neurons, with many clusters remaining unaffected. For example, with the *LRRK2-G2019S* mutation, the Protocerebral Posterior Medial (PPM) cluster dropped from 14 to 12 dopaminergic neurons but the Protocerebral Anterior Lateral (PAL) cluster remained unaffected¹³. Throughout the literature, the multiple processes involved in slowed negative geotaxis combined with the observed small loss of dopaminergic neurons act to obscure the functional relationship. To progress, we need to link a precise measurement of movement with the physiology of a few specific dopaminergic neurons.

An exciting solution to this problem is provided by the discovery that a single dopaminergic neuron strongly modulates the fly Proboscis Extension Response (PER) ¹⁴.

As a fly walks into a solution containing sucrose, the *Gr5a* chemosensory cells on its front legs are activated (Fig. 1, step 1). Their axons project to the sub-oesophageal zone of the CNS (SEZ; the part signalling the taste response, Fig. 1, step 2). Within the SEZ, the chemosensory inputs activate the interneuronal pathway ¹⁵, leading to the pharyngeal *E49* motoneurons, whose action potentials elicit contraction of the M9 muscle (Fig. 1, step 3). This well characterised neuronal pathway results in the reflex extrusion of the proboscis towards the food (Fig. 1, step 4), allowing the fly to ingest the solution. Although the sensory and motor steps in this pathway have been well defined (see for review Freeman and Dahanukar, 2015; or McKellar, 2016), the interneuronal steps mostly remain to be described.

One well-defined neuron that modulates the PER is TH-VUM, a single, unpaired neuron in the SEZ, which makes output synapses onto the sense cells and interneurons ^{14,18,19} (Fig. 1). Strong activity in the TH-VUM leads to contraction of the proboscis muscle; blocking the output of the TH-VUM reduces the probability of a sucrose-induced PER. The frequency of action potentials in the TH-VUM correlates with the length of starvation ¹⁴. Interestingly, the TH-VUM fires steadily in a way reminiscent of mammalian *substantia nigra* dopaminergic neurons ²⁰.

We have now found that expression of *LRRK2-G2019S*, the most common cause of genetic Parkinson's disease, in dopamine neurons results in a reduced PER, with bradykinesia, akinesia, and tremor, and that this is rescued by L-DOPA or by kinase inhibitors targeted at LRRK2.

Results

Upregulation of LRRK2 kinase activity in dopaminergic neurons causes akinesia

In order to test the neuronal specificity of the PD-related mutation *LRRK2-G2019S*, we first expressed this in each of the components of the PER reflex pathway, recording the proportion of a population of starved flies that extended their proboscis in response to a moderate (100 mM) sugar stimulus (Fig. 2A, B). Strikingly, when we expressed *LRRK2-G2019S* in the dopaminergic neurons with *TH-GAL4* (*tyrosine hydroxylase GAL4*), the proportion of young flies responding was about half that of control genotypes (no-transgene expressed, χ^2 -post-hoc test, $p < 0.001$; to 76 to 35 %, Fig.2A). The same result was seen in a second sample, where the proportion of *TH > G2019S* flies responding was also less than half that of the wild-type (Fig. 2B). In contrast, there was no effect of *G2019S* when driven in all neurons (*nSyb-GAL4*, $p = 0.17$), or in just the sensory neurons (*Gr5a-GAL4*, $p = 0.11$) or solely in proboscis motoneurons (*E49-GAL4*, $p = 0.21$).

In order to establish if this was specific for the *G2019S* mutation, we also tested a second PD-related mutation in which kinase activity is increased

(*I2020T*), a mutation in the GTPase domain (*R1441C*), a kinase dead form (*LRRK2-G2019S-K1906M*) and the normal human form (*hLRRK2*). Of these, only dopaminergic expression of *I2020T* had any specific effect, reducing the proportion of flies that responded from 61 to 35 % (χ^2 -post-hoc test, $p < 0.001$, Fig. 2B). We did note a general reduction on all flies containing the *hLRRK2* (Fig. 2A,B), due perhaps to the increased expression levels of this gene (Fig. 2C). In turn, the lack of effect of *TH > R1441C* might be due to the weaker expression (Fig. 2C), based on our hypothesis that the impact of any one LRRK2 mutant on PER is correlated with the level of LRRK2 protein production in the dopaminergic neurons.

We tested a second set of independently generated *LRRK2* transgenic flies²¹, and found the same: only 36% of *TH > G2019S* flies responded compared with 52 % of *TH > hLRRK2* and 61 % of *TH/+* (χ^2 -post-hoc test, *G2019S v hLRRK2* $p=0.04$; *G2019S v wild-type* $p=0.0034$).

To determine if the PER response was age dependent, we tested flies from 3 days to over 18 days, and found none of the genotypes showed any age dependent change (Fig. 2C). Dopaminergic expression of *G2019S* or *I2020T* reduced the proportion of flies responding to the sucrose stimulus at all ages.

We found no effect of genotype on mass at 20 days (non-transgene control *v TH > hLRRK2 v TH > G2019S*, $F_{2,26}$ $df = 0.003$, $p=0.99$), suggesting the reduced frequency of PER seen in starved flies was not preventing them from increasing their mass when provided with food *ad libitum*. However, by 28 days, only 57 % of flies were alive, with increased mortality in each of the *TH > hLRRK2*, *TH > G2019S* and *TH > I2020T* compared to the *TH/+* control (χ^2 -post-hoc test, $p < 0.01$ for each; survival 38, 53, 57, 80% respectively).

These experiments show that the expression of high kinase forms of *LRRK2* reduces the proportion flies showing PER, i.e. they show akinesia.

Rescue of akinesia by L-DOPA and kinase inhibitors

Since the standard symptomatic treatment for Parkinson's Disease is L-DOPA, we tested if this compound would rescue the PER deficit induced by dopaminergic expression of *G2019S* or *I2020T*. In both cases, the administration of L-DOPA to the adult flies raised the proportion of flies that respond to sucrose to control levels (Fig. 3A). This was not due to an increase in general responsiveness, because we saw no effect of L-DOPA on the flies expressing *hLRRK2*, *KD* or *R1441C*.

As the most common form of genetic Parkinson's disease is caused by the *LRRK2-G2019S* mutation, with its increased kinase activity, a promising therapy would be to deploy kinase inhibitors targeted at LRRK2. The first of these to be developed was LRRK2-IN-1²². Application of 2.5 μ M LRRK2-IN-1 partially rescued the frequency of PER responses, from 32 to 47 % ($p=0.002$, Fig. 3B). Since LRRK2-IN-1 has off-target effects, *in vitro*^{23,24} and *in vivo*⁶, we next tested the more specific compound BMPPB-32, which also gave a partial rescue, to 44% (Fig.3B). The proportion of flies showing the PER was the

same for LRRK2 and BMPPB-32 ($p=0.077$) and both were below the wild-type level (73 %).

We conclude that drugs targeted at LRRK2 ameliorate the reduced PER response of *TH > G2019S* flies.

Dopaminergic expression of LRRK2-G2019S slows movement and increases tremor in the PER

For *TH > G2019S* flies showing a PER, recordings were made using a camera with high frame rate (200 / second), and digitised the distance from the eye to the end of the proboscis, to measure the movement during the PER.

Individual traces showed that some *TH > G2019S* flies had very slow PER, taking 3 or even 4 times longer than the median wild-type control (Fig. 4A), with the increase in standard error being very noticeable (Fig. 4B). A second mutant, *I2020T*, also showed a slower PER (Fig. 4 Bii). For both *TH > G2019S* and *TH > I2020T* flies, the speed of the PER is fully rescued to wild-type by feeding 2.5 μ M BMPPB-32.

Using the independently *G2019S* and *hLRRK2* lines²¹, we also found a slower PER with *TH > G2019S*. In this case the duration of the PER increased from 0.30 ± 0.025 s (*TH/+*) to 0.57 ± 0.11 s (*TH > G2019S*) (mean \pm SE, Tukey -post-hoc test, $p=0.017$). The *TH > hLRRK2* was the same as *TH/+* ($p=0.81$).

Additionally, it appeared that the *TH > G2019S* traces were more irregular. To assess this quantitatively, each trace was fitted by a smooth curve (a piecewise cubic spline), and the deviation of the actual trace from smoothed determined (Fig. 4Ci). This showed that the *TH > G2019S* flies had a much longer 'path', about twice that of the control flies. The proboscis does not move out in a smooth trajectory, but oscillates, showing tremor. No such changes were seen in the *TH > hLRRK2* flies; they were the same as the no-transgene cross (Fig. 4Cii).

Thus dopaminergic expression of *LRRK2-G2019S* induces bradykinesia and tremor as well as akinesia.

The single dopamine neuron (TH-VUM) is mainly responsible for akinesia

Our next step was to test which dopaminergic neurons are responsible for akinesia in the PER response, focusing on the difference between flies with increased kinase activity (*G2019S* or *I2020T*) and the kinase dead (*KD*) line.

There are eight clusters of dopaminergic neurons in the fly CNS (Fig. 5B), and a range of GAL4 drivers have been developed to target various subsets of these. We started with a GAL4 driver *DDC*²⁵, which has been widely used for studies of negative geotaxis and which gives generalised dopaminergic neuron expression, as well as expressing in serotonergic neurons. As with the *TH-GAL4* (Fig. 1), fewer flies expressing *G2019S* or *I2020T* with *DDC* showed the PER compared with those flies expressing *LRRK2-KD* (Fig. 5). We next tested *HL9*²⁶ which expresses in all the dopaminergic neurons except for the PAL cluster (Fig. 5B), though it may only label a proportion of each cluster. It may also label a few non-dopaminergic neurons (Fig. 5C). Again, the *G2019S*

and *I2020T* flies were less responsive than the *KD* flies. With the *C'*-GAL4 line²⁷, which expresses in all dopaminergic neurons except the PPM3 and PPL1 clusters, we saw the same pattern: *G2019S* and *I2020T* flies showed less PER than the *KD* flies. All these GAL4 lines express in the VUM dopaminergic neurons. The final GAL4 tested, *D'*²⁷ expresses in all dopaminergic neurons except the PAL, PPL2 and does not express strongly in the VUM neurons. Remarkably, with the *D'*-GAL4, flies expressing *G2019S*, *I2020T* and *KD* forms of *LRRK2* all showed an equal response to sucrose, strikingly different from all the other dopaminergic GAL4s.

We next used a nuclear GFP (*eIfGFP* Fig. 5C) to confirm the expression pattern of the GAL4 lines in the SEZ. *DDC*, *HL9* and *C'* all showed a group of three GFP-positive neurons located posteriorly plus a fourth cell anteriorly. One of the three posterior cells is the unpaired midline TH-VUM and the other two are descending neurons (left and right DA-DNs), whose activity represents leg movements²⁸. The *D' > eIfGFP* fluorescence pattern is noticeably different: only the anterior cell shows any GFP signal (and that weakly), but the three posterior neurons not being labelled at all. The presence of the three posterior neurons is confirmed by the anti-TH staining.

Consequently, we suggest that the effect of expressing *LRRK2-G2019S* in dopaminergic neurons is mostly mediated by the single TH-VUM neuron, because the two descending neurons do not show a direct link to feeding behaviour. Only when *G2019S* is expressed in the TH-VUM do we see the reduction in PER, i.e. akinesia. However, we cannot rule out an effect of the PPL2 neurons, which also modulate the feeding system²⁹ as they are also not targeted by the *D'*-GAL4.

Discussion

Our principle finding is that expressing *LRRK2* forms with increased kinase activity (*G2019S*, *I2020T*) in sets of dopaminergic neurons that include the TH-VUM is sufficient to induce akinesia, bradykinesia and tremor in the fly proboscis extension response (PER). Although previous work with flies and rodents have identified movement disorders in Parkinson's disease models, our PER assay uniquely identifies the components of the response, in the context of changes mostly due to a single dopaminergic neuron (TH-VUM).

A key point is that our PER assay demonstrates dopaminergic-bradykinesia even at 3 days. In comparison, data from negative geotaxis (startle-induced climbing response) assays of *G2019S*, *I2020T* or *R1441C* transgenics is more complex, depending on age and genotype. One report shows that while locomotion in *DDC>I2020T* flies is already compromised at 5 days³⁰, another study shows that *TH>I2020T* flies show little deficit at any age³¹. This may be because *DDC*-GAL4 includes serotonergic, as well as dopaminergic neurons, and thus more cells compared with *TH*-GAL4. Using *DDC*-GAL4, to express *LRRK2* in old (>5 weeks) flies, *G2019S* and *R1441C* movement is shown to be reduced^{32,33}, while younger flies show no deficit. In contrast, our data shows

movement deficits in young *TH > G2019S* and *TH>I2020T* flies, which are maintained over the first few weeks of adult life. Indeed, LRRK2 mutations already start to affect *Drosophila* larvae, indicating effects at an earlier timepoint ^{21,34,35}.

One disadvantage of working with older flies is that, by 5 weeks, a proportion of flies will have died, potentially those most strongly influenced by the transgene, so that negative geotaxis assays may underestimate the real impact of LRRK2 mutations. Our assay has the advantage of working at 3 days, before flies have started to die, and potentially could be developed so that the same individual fly might be tested at different time points. This would permit comparison of the individual and population responses.

In our visual assays with *TH > G2019S*, we found that 3 day old flies showed no detectable visual deficits, though younger flies (1 day old) had overactive vision, and old flies (28 day old, or visually stressed) had much reduced response ^{6,36,37}. Overactivity has also been reported in young transgenic LRRK2 rats, followed later by loss of movement ³⁸⁻⁴⁰. We have not tested the feeding response of flies less than 3 days old, because these newly emerged flies rest and expand their cuticle, and are not feeding: this makes them unsuitable for PER assay.

However, the PER of our mildly starved 3-day-old *TH > G2019S* flies is already reduced, and remains well below wild-type levels for at least 18 days. A more pronounced PER-deficit might arise in older flies (5 weeks), and/or those kept at 29 °C to enhance transgene expression.

Further, the movement deficits in our PER assay on flies starved for 2-3 hours are mainly a consequence of expressing *G2019S* in a single dopaminergic neuron, TH-VUM, rather than the mixed effect of a range of dopaminergic clusters.

In this respect the PER assay differs from both negative geotaxis and our visual assay (3 different kinds of dopaminergic neuron are present in the retina). However, we note that longer term modulation of feeding appears to involve other dopaminergic clusters, interacting in the mushroom bodies ⁴¹. Additionally, our PER deficit occurs in young flies in which the TH-VUM is still present, offering the potential to understand the processes by which LRRK2 leads to neuronal silencing in a single identified neuron.

We find that both the akinesia and bradykinesia components of the *TH > G2019S* effect on PER are dependent on the kinase role of LRRK2. We observe no effect of expressing the *KD* (kinase-dead, *G2019S-K1906M*) form of LRRK2, although the expression level is stronger than *G2019S*. In this respect, it resembles the visual assay, where expressing *G2019S*, but not this *KD* construct led to retinal neurodegeneration ³⁷. The *TH > R1441C* flies also showed no reduction in PER, or in visual degeneration ³⁷ though it is possible that this is because *R1441C* is not so effectively expressed. The rescue by the specific LRRK2 inhibitor, BMPPB-32, argues that the reduction in PER is a consequence of phosphorylation of substrate(s) by LRRK2. We previously

showed this inhibitor was effective in a visual assay, reverting *TH > G2019S* phenotypes in both young and old flies^{6,36}. Another specific inhibitor LDN-73794 prevents loss of *DDC > G2019S* induced locomotion in old flies⁴². The PER assay has an advantage over the climbing assay (startle response), where degeneration is usually measured at 4-5 weeks, as our flies only need to be fed with the inhibitors for 3 days, reducing compound requirements.

Genetically activating or silencing the TH-VUM respectively increase or decrease the probability of a PER¹⁴. Thus, our data showing kinase active *LRRK2* transgenes in the TH-VUM reduce PER, could be explained by a reduction in dopamine release by this neuron. We hypothesise that expressing *G2019S* in the TH-VUM could lead to either (i) failure of TH-VUM neurites to grow, (ii) a reduction in its tonic firing (iii) less dopamine synthesis or (iv) lower probability of release of dopamine onto the reflex pathway. Cultured mammalian neurons, fly motoneurons and sensory cells all have reduced neurites with *G2019S*^{21,43,44}. While it is possible that *G2019S* also reduces neuritic branching in the TH-VUM neuron, our data rather favours hypotheses (iii) or (iv) since we found that feeding flies L-DOPA rescued the *TH > G2019S* loss of PER. Reduced dopamine levels have been reported with *DDC > G2019S*, and with ubiquitous expression of an increased kinase form of the fly homolog *dLRRK*^{45,46}. In both *Drosophila* and mammals, L-DOPA can cross the blood-brain barrier (BBB), but dopamine cannot⁴⁷. Thus we suggest that uptake of L-DOPA into the TH-VUM leads to increased dopamine levels and release, rescuing the effect of *TH > G2019S*. Increasing the amount of dopamine released onto the sugar sensing *Gr5a* neurons would then rescue the proportion of flies that show the PER (akinesia), while release onto second order, local interneurons, might affect the motoneurons and thence speed (bradykinesia), and tremor of the proboscis extension. Such a dual output onto *Gr5a* neurons and onto local interneurons is suggested by the fact that 2.5 μ M BMPPB-32 fully rescues bradykinesia, but only partially rescues akinesia. Although a number of interneurons in the SEZ with roles controlling proboscis extension, ingestion, and memory have recently been identified (e.g. Cheung et al., 2017; Kim et al., 2017; Yapici et al., 2016), the link between *Gr5a* sense cells and the *E49* motoneurons remains to be established.

Methods

Flies, *Drosophila melanogaster*, were raised at 25 °C on cornmeal-sugar-agar-yeast food. The following GAL4 lines were used: *TH* (*tyrosine hydroxylase*) GAL4⁵¹, *DDC*-GAL4²⁵, *HL9*²⁶ or the *C'* and *D'*-GAL4 stocks²⁷, the pan-neuronal *nSyb*-GAL4 (Stephen Goodwin), the sensory *Gr5a*-GAL4 and motoneuron *E49*-GAL4¹⁸. The UAS lines were: wild-type *hLRRK2* or *LRRK2-G2019S*³², *hLRRK2-I2020T* and the kinase dead line *LRRK2-G2019S-K1906M* (hereafter, *KD*)²¹, and *hLRRK2-R1441C*³¹; *eIfGFP* (*eIF4AIII::GFP*, Andreas Prokop). In some confirmatory experiments, independent *LRRK2-G2019S* and

hLRRK2 lines were used ²¹. The lab stocks of *CS* (*Canton-S*), *w¹¹¹⁸* (*w⁻*) and *w^{apricot}* (*w^{apricot}* Bloomington stock 148) provided 'wild-type' outcross controls.

PER (proboscis extension response) was performed (A.C.C.) by collecting male flies of known age at the start of the working day, under CO₂ anesthesia, and sticking them ventral side up to card with rubber cement (Fixo Gum). Flies were left to recover for 2-3 hours at 25 °C. They were presented with a droplet of 100 mM sucrose solution to the legs, and the immediate PER/no PER scored (response in < 2 s). Experiments were designed so that each graph plotted here comes from flies scored over 3 adjacent days, with the genotypes mixed each day, to allow for the small variations in food and environmental conditions. Power calculations indicate that a 'medium' effect size, with a sample of 500 flies, and 16 df, would be detected at the 1 % level >98% of the time.

Drugs were fed to adult flies from eclosion until testing. L-DOPA (Sigma) was added to food (final concentration 50 µM). BMPPB-32 and LRRK2-IN-1 (Lundbeck) were dissolved to give a final concentration in the food at 2.5 µM.

PER was filmed using a Mikrotron MC-1362 camera mounted on a Zeiss Stemi microscope. Videos were acquired at 200 frames/second; sample movies for a wild-type and *TH > G2019S* flies are presented in Movies S1 and S2. . Only the first PER of each fly was analyzed. In Matlab, the eye and tip of the proboscis were marked and their separation was determined for each frame individually. The analyses of Movies S1 and S2 are shown in Movies S3 and S4, respectively.

Western Blots were performed as described ⁶ using the heads of 3-day old female flies, raised at 29 °C using anti-LRRK2 (Neuromab, clone N241A/34,, 1:1000) and anti-β-actin (Proteintech, 1:180000, loading control). The data is representative of three blots.

Immunocytochemistry was as described recently ³⁷, using mouse anti-TH (Immunostar, 1:1000) and driving *elF^{GFP}* using the required GAL4 line. All data is from male flies, aged 3-5 days. No anti-GFP was used in the data chosen for illustration. The brightness and contrast of the images was adjusted in ImageJ so that the cells could be seen in both colour channels, as each GAL4 drove GFP with a different intensity in the VUM neurons. Original images available on request to cje2@york.ac.uk Representative data from at least three preparations shown.

Statistics. For analysis of the proportion of flies showing a PER, statistical significance was determined using the χ^2 -post-hoc test in the 'Fifer' package of R. Confidence limits were determined using the Binomial test in R. Measurements of the speed of the PER were analyzed by ANOVA and Tukey post-hoc tests. For a 'medium' effect size, with 26 flies in each of 3 samples, and the probability of 0.05, the power is 63%. N values for each genotype / treatment are included in Supplementary Table 1.

Acknowledgements

We are grateful to Parkinson's UK and The Wellcome Trust for support, to Kirsten Scott, Serge Birman, Wanli Smith, Cheng-Ting Chien, Stephen Goodwin, Andreas Prokop and Mark Wu for the kind gifts of fly stocks and to Lundbeck A/S for supplies of BMPPB-32 and LRRK2-IN-1.

Competing Interests

The Elliott lab is partially supported by Lundbeck A/S.

Contributions

AC designed and performed experiments; NS analysed video; SP did Western Blots; CAM was responsible for the immunocytochemistry; LW organized the video and its analysis; CJHE designed experiments, analysed the results and wrote the manuscript; all contributors revised the manuscript.

Funding

This project was supported by The Wellcome Trust (through the Centre for Chronic Diseases and Disorders, C2D2) and Parkinson's UK (H1201)

Data Availability Statement

The data that support the findings of this study are available from the corresponding author upon reasonable request.

.

References

1. Singleton, A. B., Farrer, M. J. & Bonifati, V. The genetics of Parkinson's disease: Progress and therapeutic implications. *Mov. Disord.* **28**, 14–23 (2013).
2. Healy, D. G. *et al.* Phenotype, genotype, and worldwide genetic penetrance of LRRK2-associated Parkinson's disease: a case-control study. *Lancet Neurol.* **7**, 583–90 (2008).
3. Greggio, E. & Cookson, M. R. Leucine-rich repeat kinase 2 mutations and Parkinson's disease: three questions. *ASN Neuro* **1**, e00002 (2009).
4. Lewis, P. A. *et al.* The R1441C mutation of LRRK2 disrupts GTP hydrolysis. *Biochem. Biophys. Res. Commun.* **357**, 668–71 (2007).
5. Hewitt, V. L. & Whitworth, A. J. in *Current topics in developmental biology* **121**, 173–200 (2017).
6. Afsari, F. *et al.* Abnormal visual gain control in a Parkinson's disease model. *Hum. Mol. Genet.* **23**, 4465–4478 (2014).
7. Barone, M. C. & Bohmann, D. Assessing neurodegenerative phenotypes in *Drosophila* dopaminergic neurons by climbing assays and whole brain immunostaining. *J. Vis. Exp.* e50339 (2013).
8. Gargano, J. W., Martin, I., Bhandari, P. & Grotewiel, M. S. Rapid iterative negative geotaxis (RING): a new method for assessing age-related locomotor decline in *Drosophila*. *Exp. Gerontol.* **40**, 386–95 (2005).
9. Phillips, M., Roberts, S., Kladt, N., Reiser, M. B. & Korff, W. An automated, high-throughput climbing assay for behavioral screening in *Drosophila*. *Front. Behav. Neurosci.* 357 (2012).
10. Mao, Z. & Davis, R. L. Eight different types of dopaminergic neurons innervate the *Drosophila* mushroom body neuropil: anatomical and physiological heterogeneity. *Front. Neural Circuits* **3**, 5 (2009).
11. Drobysheva, D. *et al.* An optimized method for histological detection of dopaminergic neurons in *Drosophila melanogaster*. *J. Histochem. Cytochem.* **56**, 1049–1063 (2008).
12. Riemensperger, T. *et al.* A single dopamine pathway underlies progressive locomotor deficits in a *Drosophila* model of Parkinson disease. *Cell Rep.* **5**, 952–60 (2013).
13. Martin, I. *et al.* Ribosomal Protein s15 Phosphorylation Mediates LRRK2 Neurodegeneration in Parkinson's Disease. *Cell* **157**, 472–485 (2014).
14. Marella, S., Mann, K. & Scott, K. Dopaminergic modulation of sucrose acceptance behavior in *Drosophila*. *Neuron* **73**, 941–50 (2012).
15. Getting, P. A. The sensory control of motor output in fly proboscis

- extension. *Z. Vgl. Physiol.* **74**, 103–120 (1971).
16. Freeman, E. G. & Dahanukar, A. Molecular neurobiology of *Drosophila* taste. *Curr. Opin. Neurobiol.* **34**, 140–8 (2015).
 17. McKellar, C. E. Motor control of fly feeding. *J. Neurogenet.* **30**, 101–111 (2016).
 18. Gordon, M. D. & Scott, K. Motor control in a *Drosophila* taste circuit. *Neuron* **61**, 373–84 (2009).
 19. Inagaki, H. K. *et al.* Visualizing neuromodulation in vivo: TANGO-mapping of dopamine signaling reveals appetite control of sugar sensing. *Cell* **148**, 583–95 (2012).
 20. Janezic, S. *et al.* Deficits in dopaminergic transmission precede neuron loss and dysfunction in a new Parkinson model. *Proc. Natl. Acad. Sci. U. S. A.* **110**, E4016–25 (2013).
 21. Lin, C.-H. H., Tsai, P.-I. I., Wu, R.-M. M. & Chien, C.-T. T. LRRK2 G2019S mutation induces dendrite degeneration through mislocalization and phosphorylation of tau by recruiting autoactivated GSK3 β . *J. Neurosci.* **30**, 13138–13149 (2010).
 22. Deng, X. *et al.* Characterization of a selective inhibitor of the Parkinson's disease kinase LRRK2. *Nat. Chem. Biol.* **7**, 203–5 (2011).
 23. Weygant, N. *et al.* Small molecule kinase inhibitor LRRK2-IN-1 demonstrates potent activity against colorectal and pancreatic cancer through inhibition of doublecortin-like kinase 1. *Mol. Cancer* **13**, 103 (2014).
 24. Luerman, G. C. *et al.* Phosphoproteomic Evaluation Of Pharmacological Inhibition Of Leucine-Rich Repeat Kinase 2 Reveals Significant Off-Target Effects Of Lrrk-2-In-1. *J. Neurochem.* **128** 561–76 (2014).
 25. Li, H., Chaney, S., Forte, M. & Hirsh, J. Ectopic G-protein expression in dopamine and serotonin neurons blocks cocaine sensitization in *Drosophila melanogaster*. *Current Biology* **10**, (2000).
 26. Claridge-Chang, A. *et al.* Writing Memories with Light-Addressable Reinforcement Circuitry. *Cell* **139**, 405–415 (2009).
 27. Liu, Q., Liu, S., Kodama, L., Driscoll, M. R. & Wu, M. N. Two dopaminergic neurons signal to the dorsal fan-shaped body to promote wakefulness in *Drosophila*. *Curr. Biol.* **22**, 2114–23 (2012).
 28. Tschida, K. & Bhandawat, V. Activity in descending dopaminergic neurons represents but is not required for leg movements in the fruit fly *Drosophila*. *Physiol. Rep.* **3**, (2015).
 29. Yang, C.-H., He, R. & Stern, U. Behavioral and circuit basis of sucrose rejection by *Drosophila* females in a simple decision-making task. *J. Neurosci.* **35**, 1396–410 (2015).

30. Linhart, R. *et al.* Vacuolar protein sorting 35 (Vps35) rescues locomotor deficits and shortened lifespan in *Drosophila* expressing a Parkinson's disease mutant of Leucine-rich repeat kinase 2 (LRRK2). *Mol. Neurodegener.* **9**, 23 (2014).
31. Venderova, K. *et al.* Leucine-rich repeat kinase interacts with Parkin, DJ-1 and PINK-1 in a *Drosophila melanogaster* model of Parkinson's disease. *Hum Mol Genet* **18**, 4390–4404 (2009).
32. Liu, Z. *et al.* A *Drosophila* model for LRRK2-linked parkinsonism. *Proc. Natl. Acad. Sci. U. S. A.* **105**, 2693–8 (2008).
33. Islam, M. S. *et al.* Human R1441C LRRK2 regulates the synaptic vesicle proteome and phosphoproteome in a *Drosophila* model of Parkinson's disease. *Hum. Mol. Genet.* **500**, 5365–5382 (2016).
34. Penney, J. *et al.* LRRK2 regulates retrograde synaptic compensation at the *Drosophila* neuromuscular junction. *Nat. Commun.* **7**, 12188 (2016).
35. Lin, C.-H. *et al.* Lovastatin protects neurite degeneration in LRRK2-G2019S parkinsonism through activating the Akt/Nrf pathway and inhibiting GSK3 β activity. *Hum. Mol. Genet.* **25**, 1965–1978 (2016).
36. Mortiboys, H. *et al.* UDCA exerts beneficial effect on mitochondrial dysfunction in LRRK2(G2019S) carriers and in vivo. *Neurology* **85**, 846–52 (2015).
37. Hindle, S. J. *et al.* Dopaminergic expression of the Parkinsonian gene LRRK2-G2019S leads to non-autonomous visual neurodegeneration, accelerated by increased neural demands for energy. *Hum Mol Genet* **22**, 2129–2140 (2013).
38. Sloan, M. *et al.* LRRK2 BAC transgenic rats develop progressive, L-DOPA-responsive motor impairment, and deficits in dopamine circuit function. *Hum. Mol. Genet.* (2016). doi:10.1093/hmg/ddv628
39. Longo, F., Russo, I., Shimshek, D. R., Greggio, E. & Morari, M. Genetic and pharmacological evidence that G2019S LRRK2 confers a hyperkinetic phenotype, resistant to motor decline associated with aging. *Neurobiol. Dis.* **71**, 62–73 (2014).
40. Zhou, H. *et al.* Temporal expression of mutant LRRK2 in adult rats impairs dopamine reuptake. *Int. J. Biol. Sci.* **7**, 753–61 (2011).
41. Kirkhart, C. & Scott, K. Gustatory learning and processing in the *Drosophila* mushroom bodies. *J. Neurosci.* **35**, 5950–8 (2015).
42. Yang, D. *et al.* LDN-73794 Attenuated LRRK2-Induced Degeneration in a *Drosophila* Parkinson's Disease Model. **4**, 49–49 (2015).
43. Lin, C.-H. *et al.* Lrrk regulates the dynamic profile of dendritic Golgi outposts through the golgin Lava lamp. *J. Cell Biol.* (2015).
44. MacLeod, D. *et al.* The familial Parkinsonism gene LRRK2 regulates

- neurite process morphology. *Neuron* **52**, 587–93 (2006).
45. Imai, Y. *et al.* Phosphorylation of 4E-BP by LRRK2 affects the maintenance of dopaminergic neurons in *Drosophila*. *EMBO J* **27**, 2432–2443 (2008).
 46. Merzetti, E. M. & Staveley, B. E. spargel, the PGC-1 α homologue, in models of Parkinson disease in *Drosophila melanogaster*. *BMC Neurosci.* **16**, 70 (2015).
 47. Cichewicz, K. *et al.* A new brain dopamine-deficient *Drosophila* and its pharmacological and genetic rescue. *Genes, Brain Behav.* **16**, 394–403 (2017).
 48. Yapici, N., Cohn, R., Schusterreiter, C., Ruta, V. & Vosshall, L. B. A Taste Circuit that Regulates Ingestion by Integrating Food and Hunger Signals. *Cell* **165**, 715–729 (2016).
 49. Kim, H., Kirkhart, C. & Scott, K. Long-range projection neurons in the taste circuit of *Drosophila*. *Elife* **6**, (2017).
 50. Cheung, S. K. *et al.* GABAA receptor-expressing neurons promote consumption in *Drosophila melanogaster*. *PLoS One* **12**, e0175177 (2017).
 51. Friggi-Grelin, F. *et al.* Targeted gene expression in *Drosophila* dopaminergic cells using regulatory sequences from tyrosine hydroxylase. *J. Neurobiol.* **54**, 618–27 (2003).
 52. Lones, M. A. *et al.* Computational approaches for understanding the diagnosis and treatment of Parkinson's disease. *IET Syst. Biol.* (2015). doi:10.1049/iet-syb.2015.0030
 53. Schwarz, O. *et al.* Motor control of *Drosophila* feeding behavior. *Elife* **6**, (2017).

Figure legends.

Fig. 1. The proboscis extension response (PER) of *Drosophila*. A. The PER takes place when sugar sensitive (*Gr5a*) neurons on the legs respond (step 1) and signal to the sub-esophageal zone of the CNS (SEZ, step 2). This leads to activation of the *E49* motoneurons for the proboscis extension muscle (step 3), muscle contraction (step 4) and extension of the proboscis (step 5). In the sub-esophageal zone, the neuronal signal is modulated by a dopaminergic neuron, TH-VUM, and by other inputs from CNS neurons, possibly including other dopaminergic neurons. B. Schematic neural circuit, showing the modulation of the sensory neuron – interneuron – motoneuron axis by TH-VUM. Other interneurons also modulate the proboscis extension response, as reviewed recently¹⁷. A modified after^{52,53}; B after^{14,15,19}.

Fig 2. The PER shows bradykinesia with dopaminergic expression of two *LRRK2* mutations (*G2019S*, *I2020T*) that have increased kinase activity. This reduces the proportion of flies that respond to sucrose stimulation with a proboscis extension response. A. Comparison of the expression of a Parkinson's mutant with upregulated kinase activity (*LRRK2-G2019S*) with wild-type *hLRRK2*, and a kinase dead line (*KD*, *LRRK2-G2019S-K1906M*). Each group of bars shows the effect of transgene expression in dopaminergic neurons (using the *TH GAL4*), the sugar sensitive neurons on the legs (*Gr5a GAL4*), in the proboscis motoneurons (*E49 GAL4*) in relation to outcross controls (+) in which no transgene was expressed. *N* = 1972, at least 60 flies per sample. B. Dopaminergic expression of two increased kinase lines (*G2019S*, *I2020T*) reduces the PER at all ages. There is no decline in the proportion of flies showing PER with age, up to 28 days. *N* = 1839, at least 75 flies in each sample. C. Western Blot showing that dopaminergic expression of *hLRRK2* or *KD* leads to stronger staining than *LRRK2-G2019S*, while the *R1441C* is slightly weaker. In A & B, wild-type (+) is *TH/w^a*; in C, *w⁻* and *CS*. Data derived from different flies in A & B. In C, flies were raised together, so that the samples derive from the same experiment and were processed in parallel.

Fig. 3. L-DOPA and *LRRK2*-specific kinase inhibitors both rescue the bradykinesia induced by kinase mutations in the PER. A. Feeding 50 μ M L-DOPA rescues the reduction in PER by dopaminergic expression of *LRRK2-G2019S* or *LRRK2-I2020T* to wild-type levels. L-DOPA has no effect on *hLRRK2*, kinase dead (*KD*, *LRRK2-G2019S-K1906M*) or the GTPase mutant (*R1441C*). All transgenes expressed by the *TH GAL4*. The wild-type (+) is *w⁻*. *N* = 902, at least 60 flies per sample. B. *LRRK2* kinase inhibitors rescue the reduction in PER caused by dopaminergic expression of *LRRK2-G2019S*. Flies were fed with either 2.5 μ M BMPPB-32 or *LRRK2-IN-1*. Neither drug affects the controls or flies with dopaminergic expression of *hLRRK2*, *KD*, or *R1441C*. Exact genotypes: +/+ *CS/w⁻*; *TH/+ TH GAL4/CS*. *N* = 3387, at least 130 flies per sample.

Fig. 4. Dopaminergic expression of *LRRK2-G2019S* (*TH GAL4*) slows and increases tremor in the PER. A. The raw plot of the distance between the eye and the tip of the proboscis shows that the PER takes longer, and is more variable, with *TH > G2019S* than with *TH > hLRRK2* or the control with no transgene expressed (*TH/+*). B. Summary showing the longer (and more variable) time taken by the PER in *TH > G2019S* and *TH > I2020T* flies. Feeding 2.5 μ M BMPPB-32 reverts the time taken to control levels. C. Fitting a cubic spline to each trace (i) generates a smooth curve, allowing the calculation of the extra path taken by the proboscis. The mean extra path (ii) is longer for *TH > G2019S* than the wild-type or *TH > hLRRK2*, indicating increased tremor. Data for A, Bi and C from the same data set, $N = 80$, at least 26 in each group; for Bii $N = 141$, at least 15 in each group. *TH/+* is *TH/w⁻*.

Fig. 5. The presence of dopaminergic TH-VUM neuron is essential for the *G2019S/I2020T* mediated reduction in PER. A. Proportion of flies responding when *LRRK2* transgenes are expressed in different subsets of the dopaminergic neurons, using the *DDC*, *HL9*, *C'* or *D'* *GAL4* drivers. There is no difference between the increased kinase mutants (*G2019S/I2020T*) and the kinase-dead construct (*KD*, *G2019S-K1906M*) with the *D'* *GAL4*, which does not express in the TH-VUM neurons. All the other *GAL4* lines tested express in the TH-VUM neurons and show a smaller response in *G2019S/I2020T* than in *KD*. Exact genotypes: + is *w^a*. B. Summary maps of the expression patterns of the *GAL4* drivers used in A. Figures redrawn after Mao and Davis (2009). C. The lack of TH-VUM in the *D'* line is confirmed anatomically. Each panel shows the projection of a confocal stack through the sub-esophageal zone (as marked in the first panel by the dotted box). Neurons marked by expression of *eIfGFP* under the control of the relevant *GAL4* and stained by anti-TH antibody. The SEZ contains a single anterior cell ('a') and a group of 3 posterior cells ('p'), marked with anti-TH antibody. With *DDC*, *HL9* and *C'* *GAL4* drivers, all four SEZ neurons were GFP-positive. With *D'*, the nucleus of the anterior neuron 'a' has a weak GFP signal, but the 3 posterior neurons marked with anti-TH antibody do not fluoresce green (note the cytoplasm of the two left posterior cells is merged in this projection of the z-stack, but their empty nuclei are still visible). Scalebar 20 μ m.

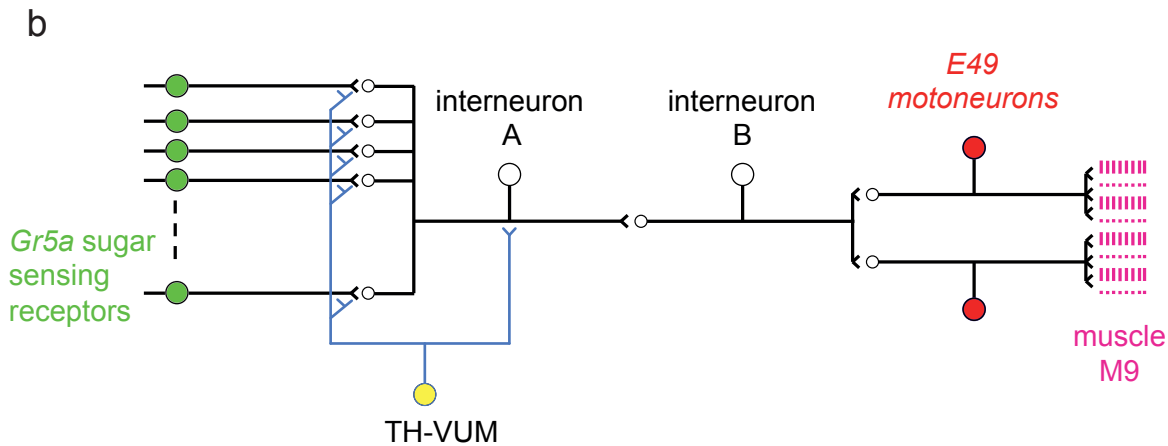
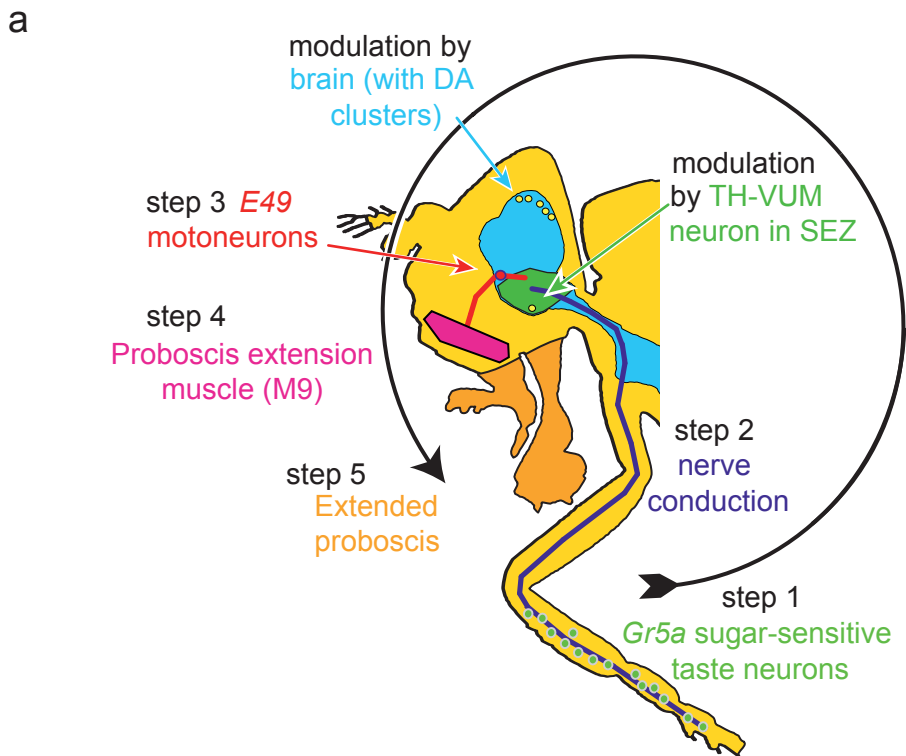

a

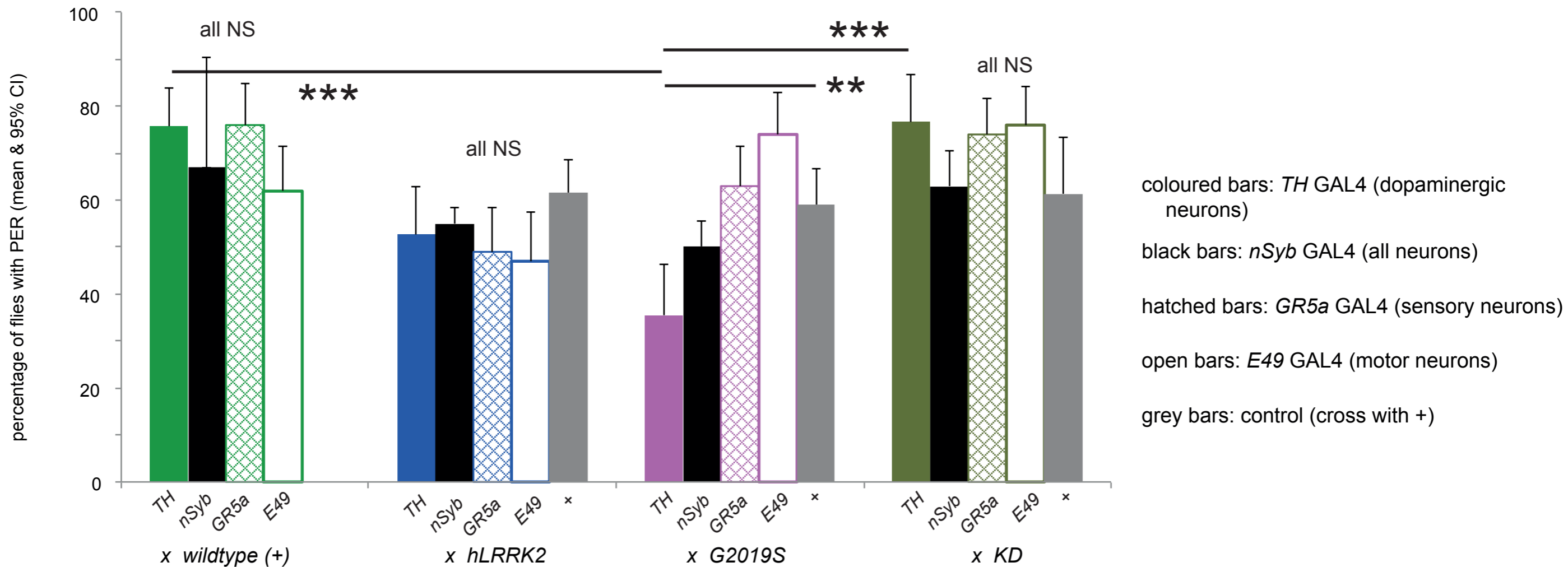

b

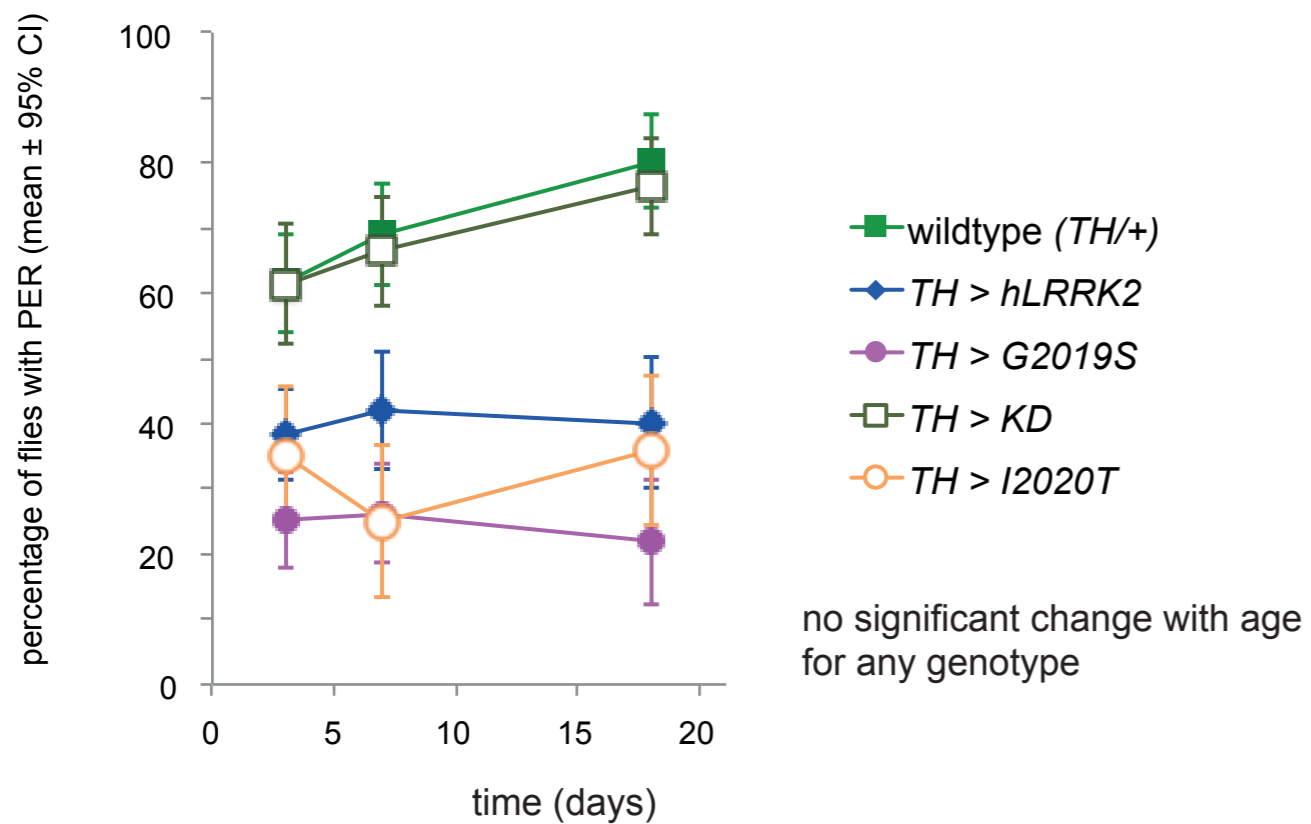

c

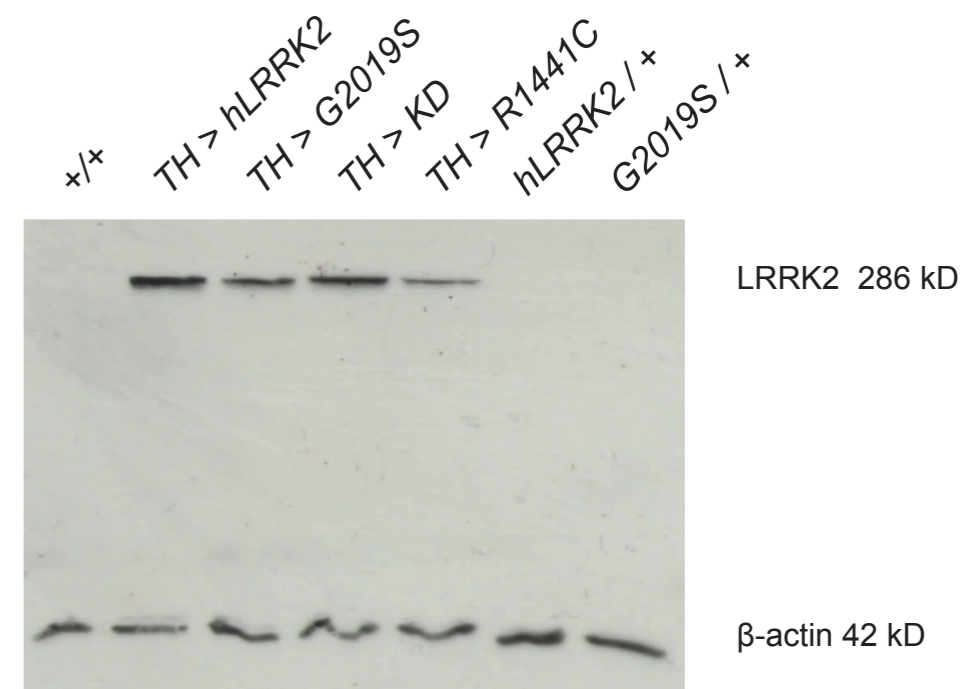

a

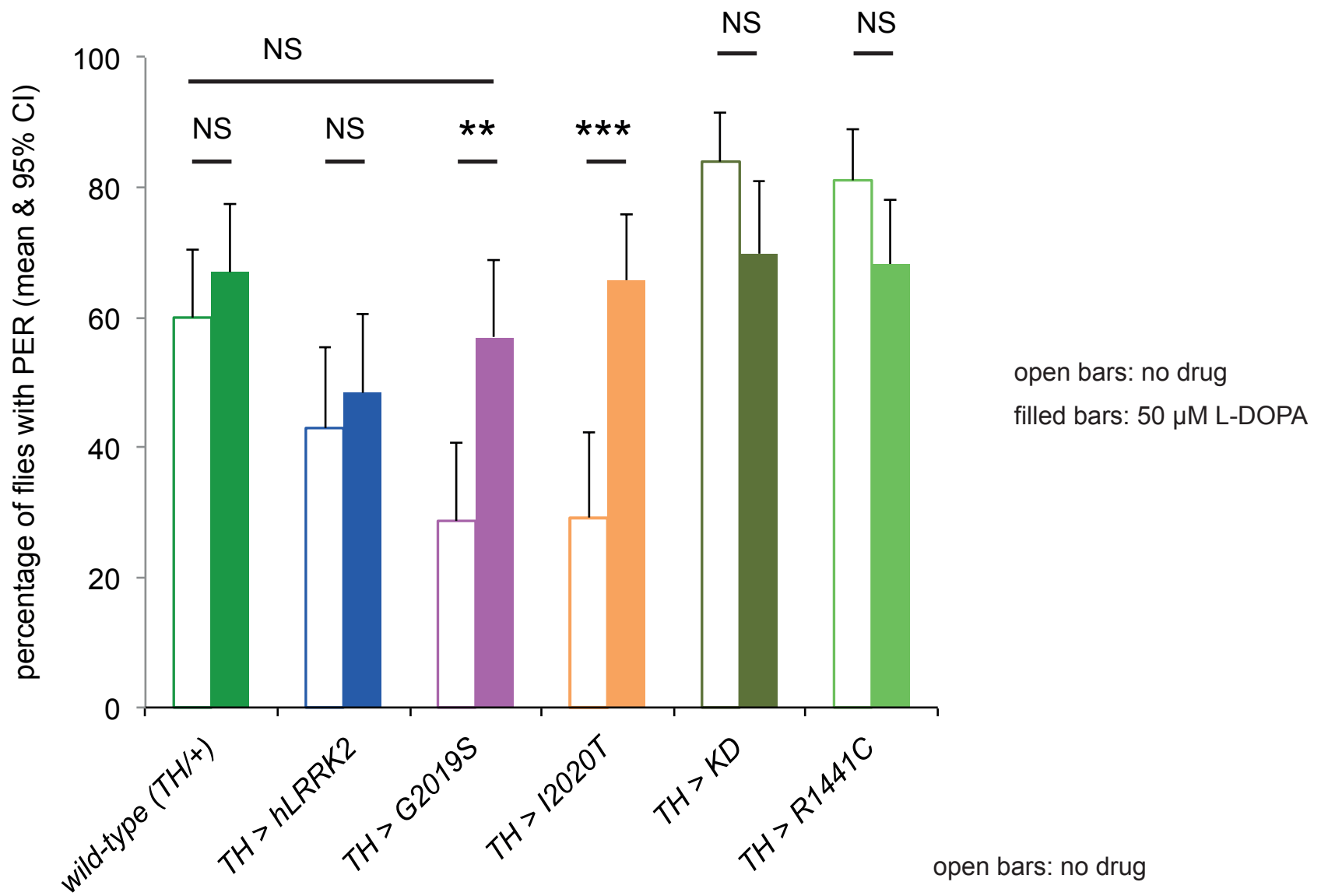

b

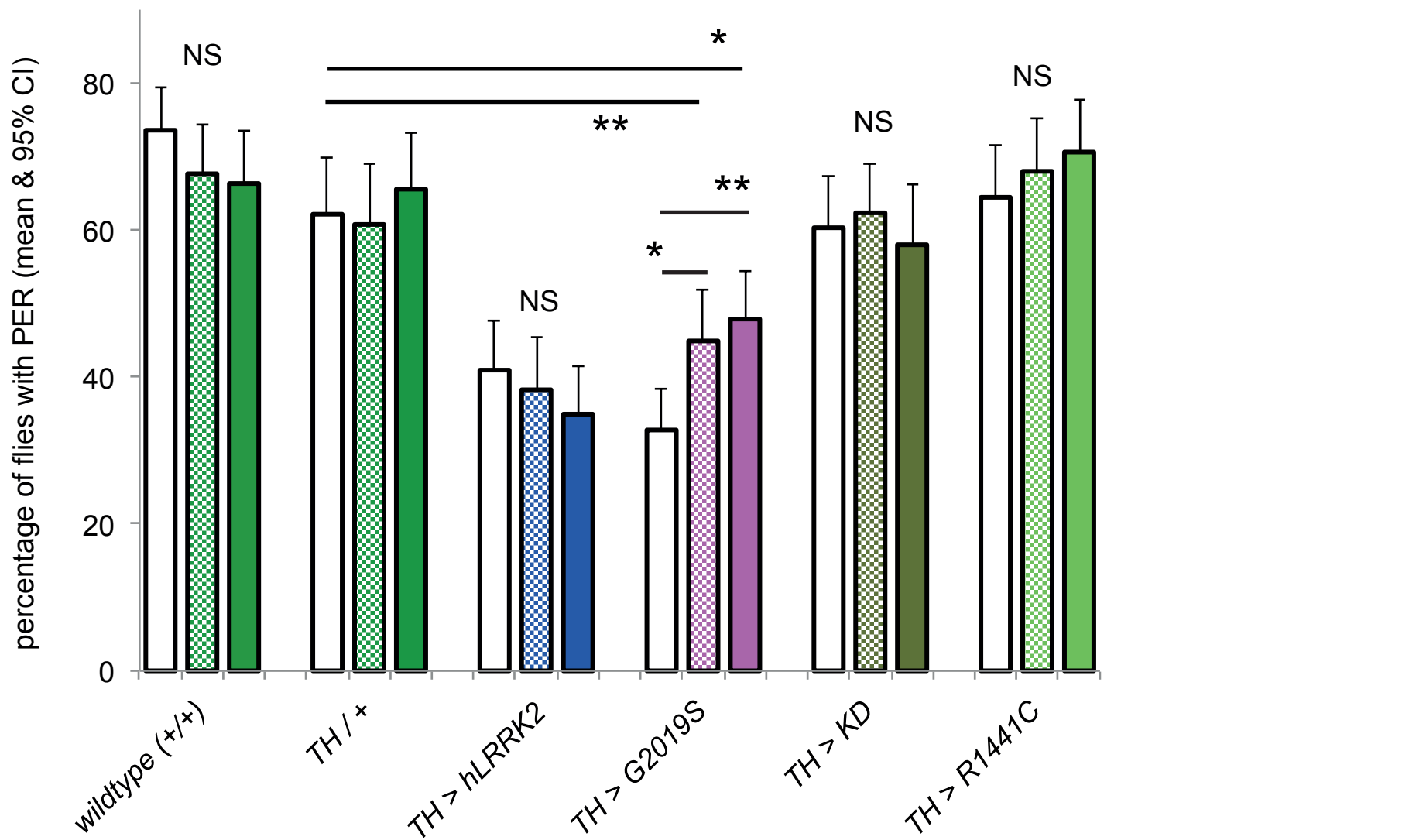

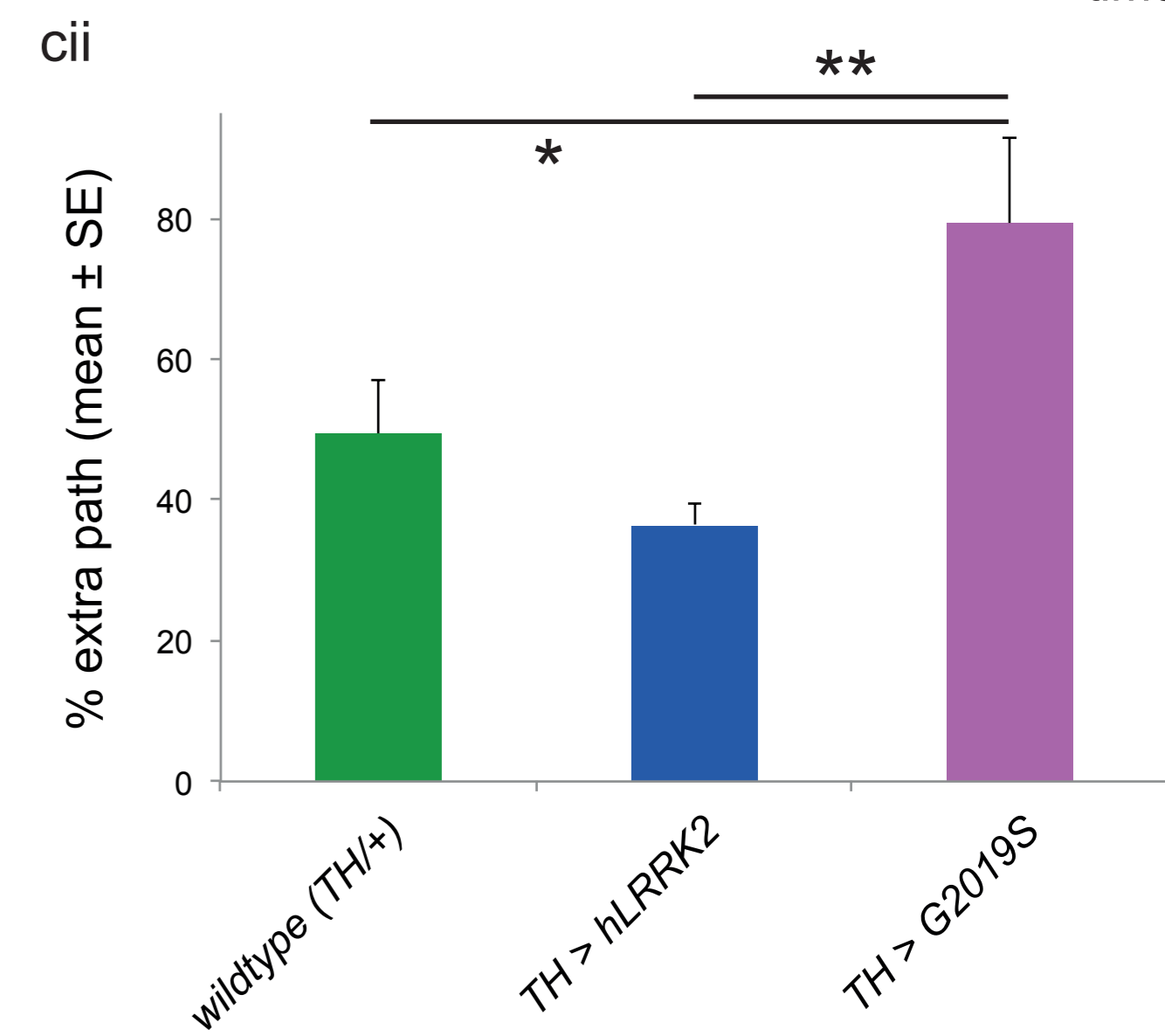
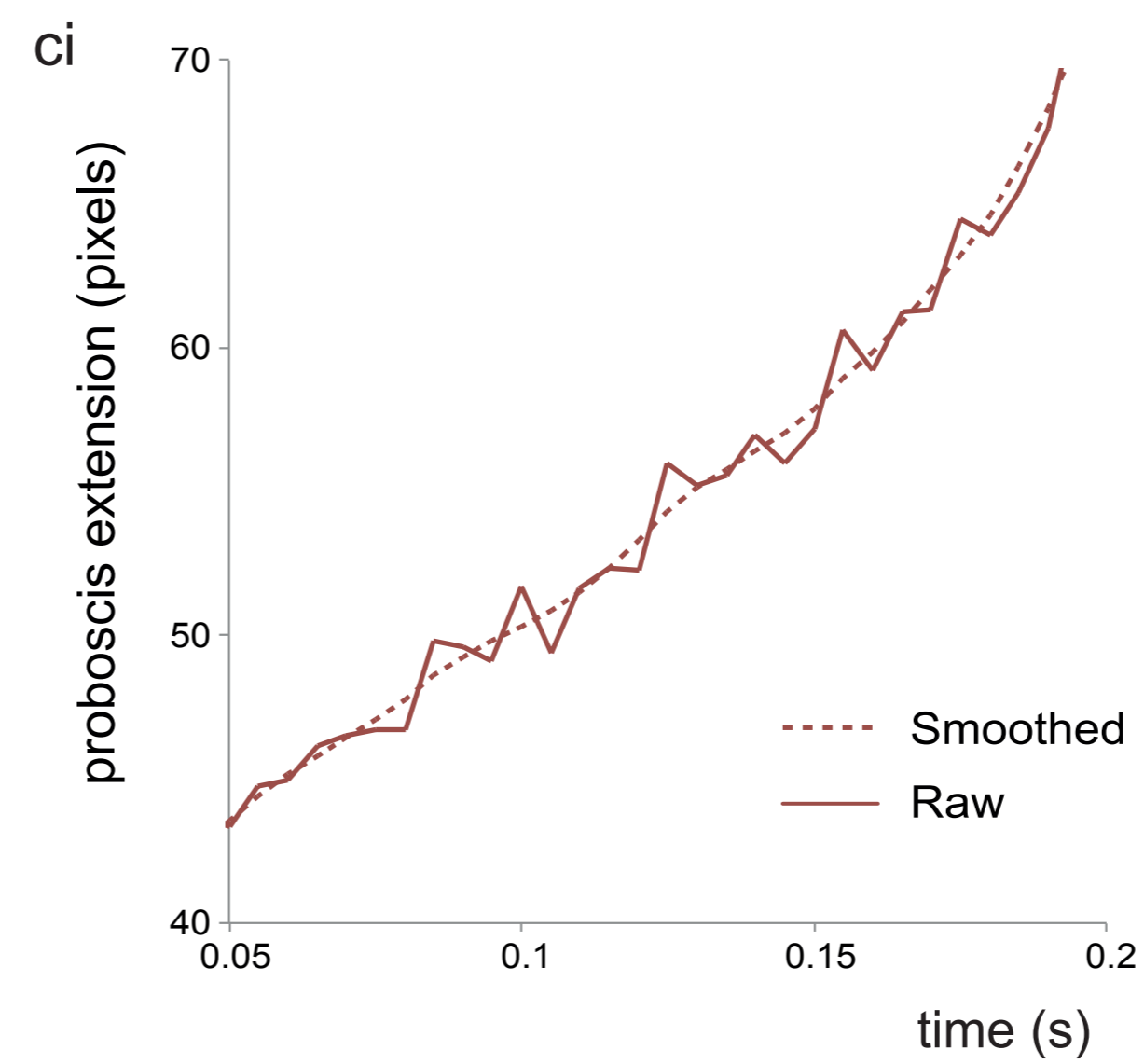
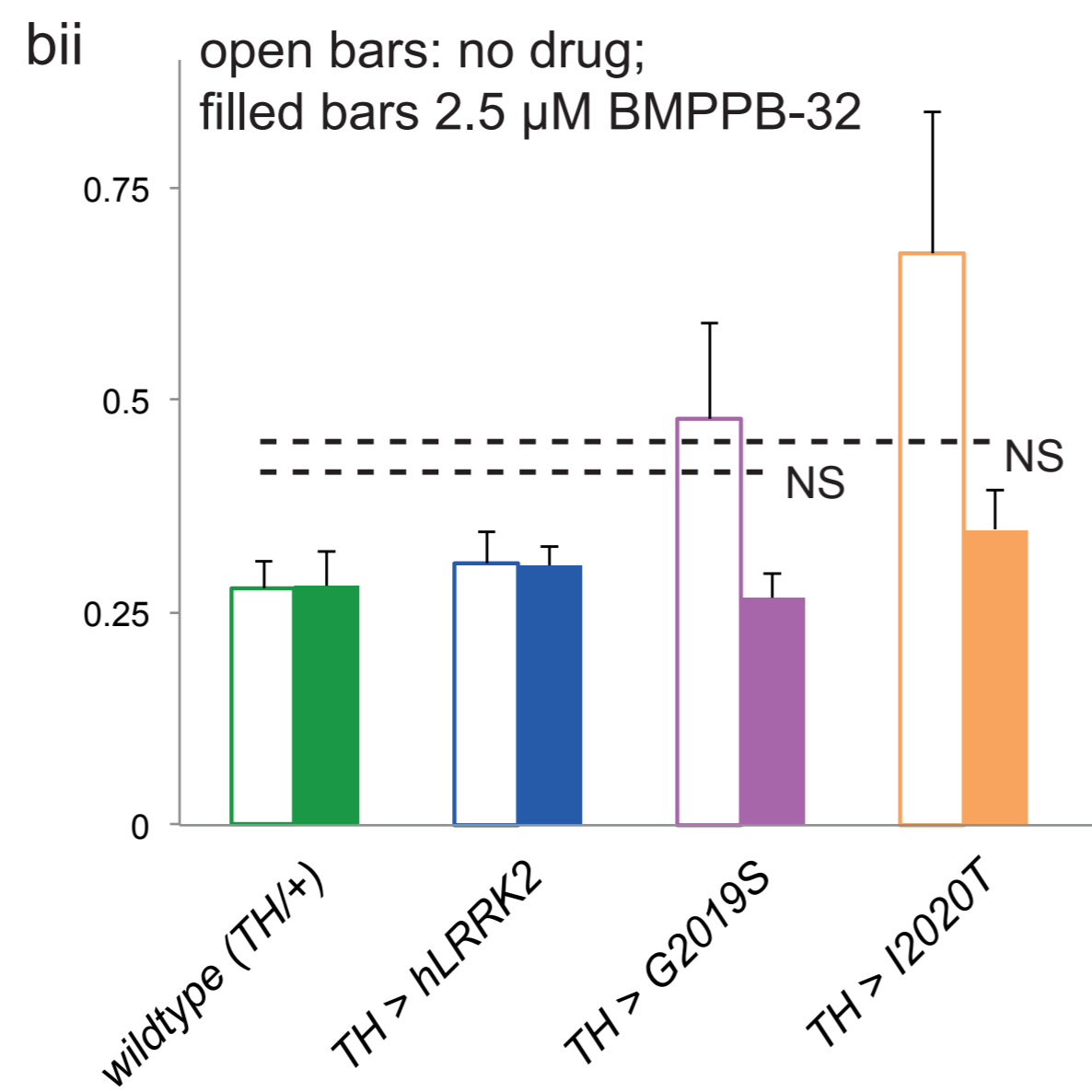
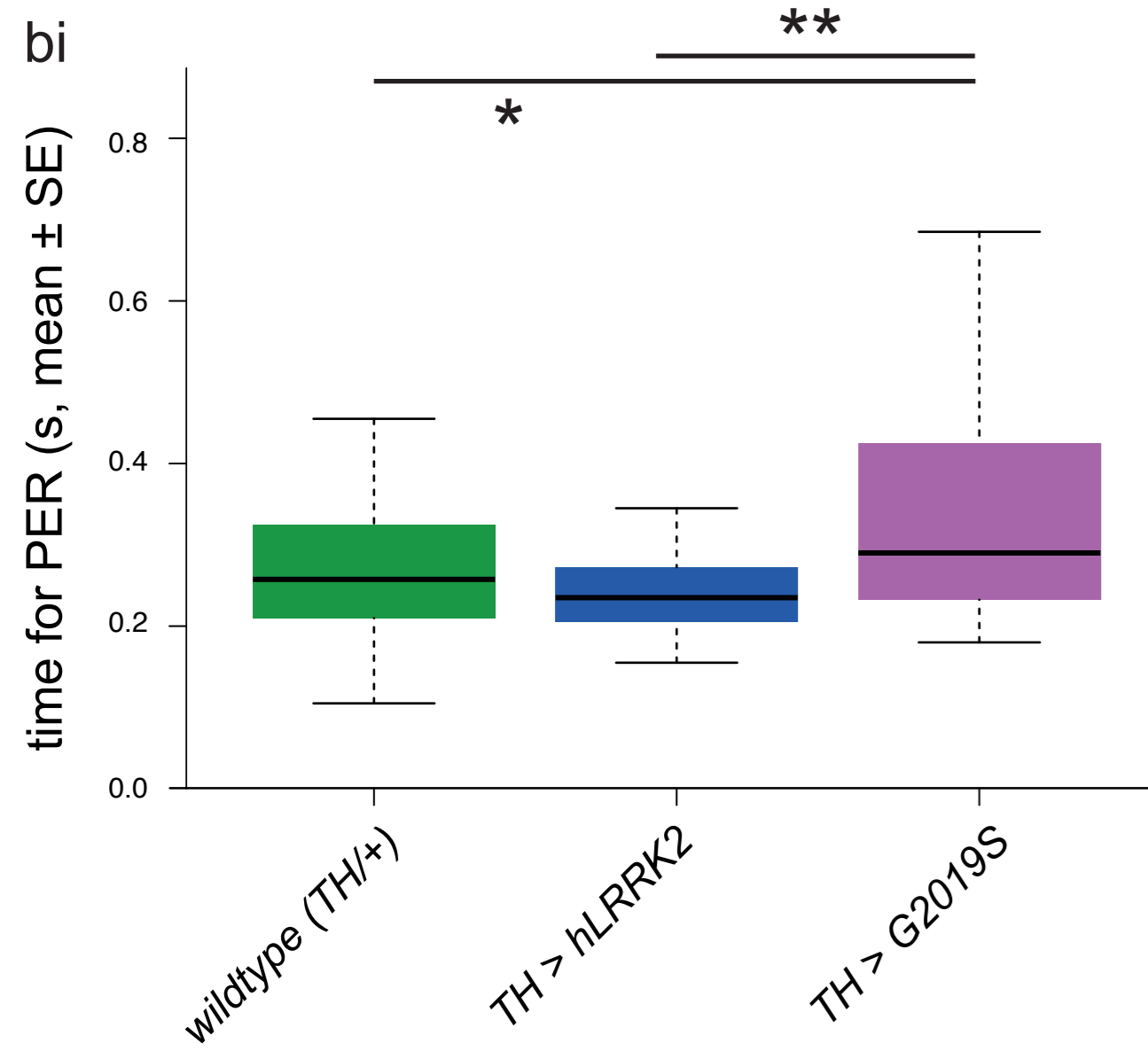
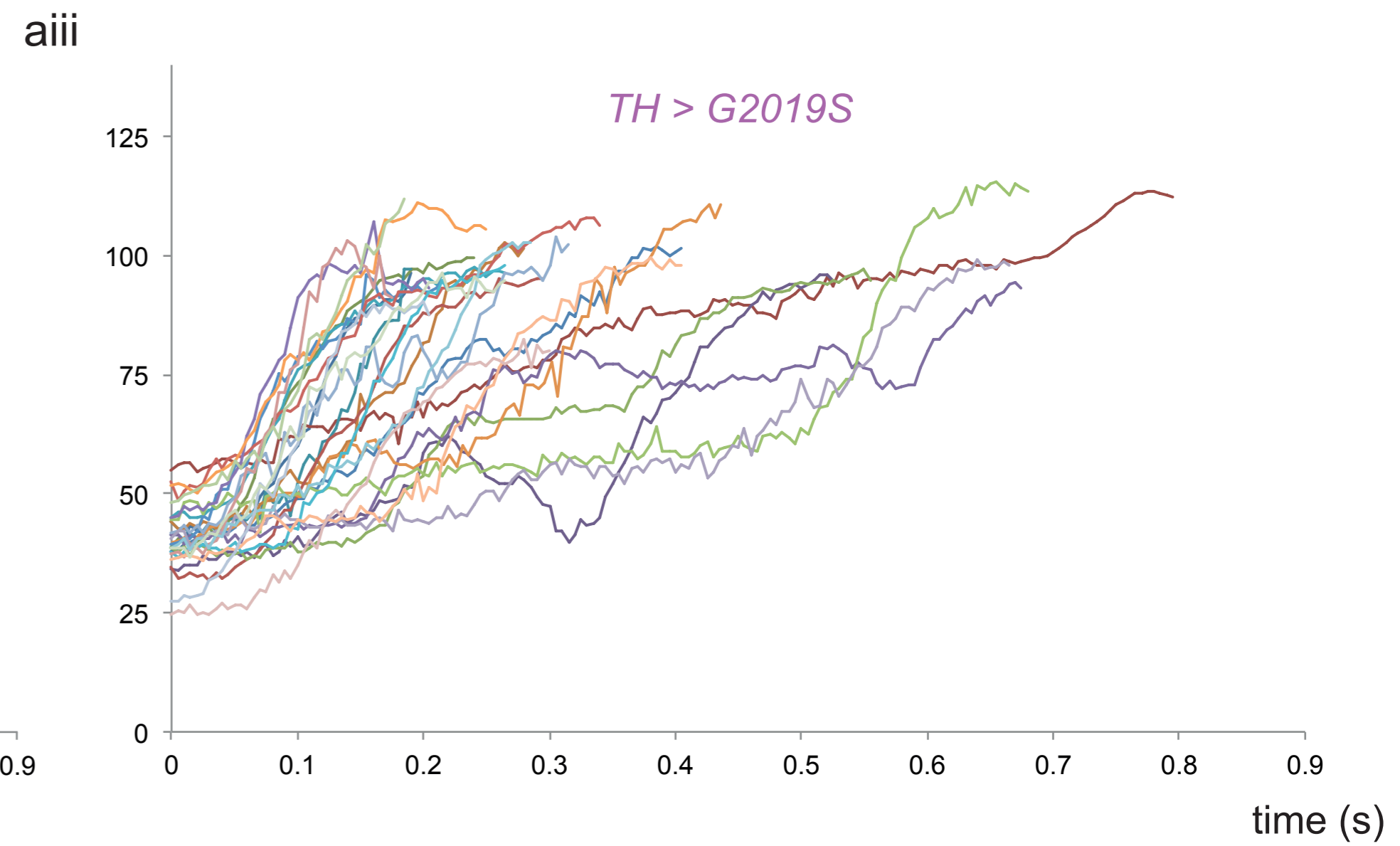
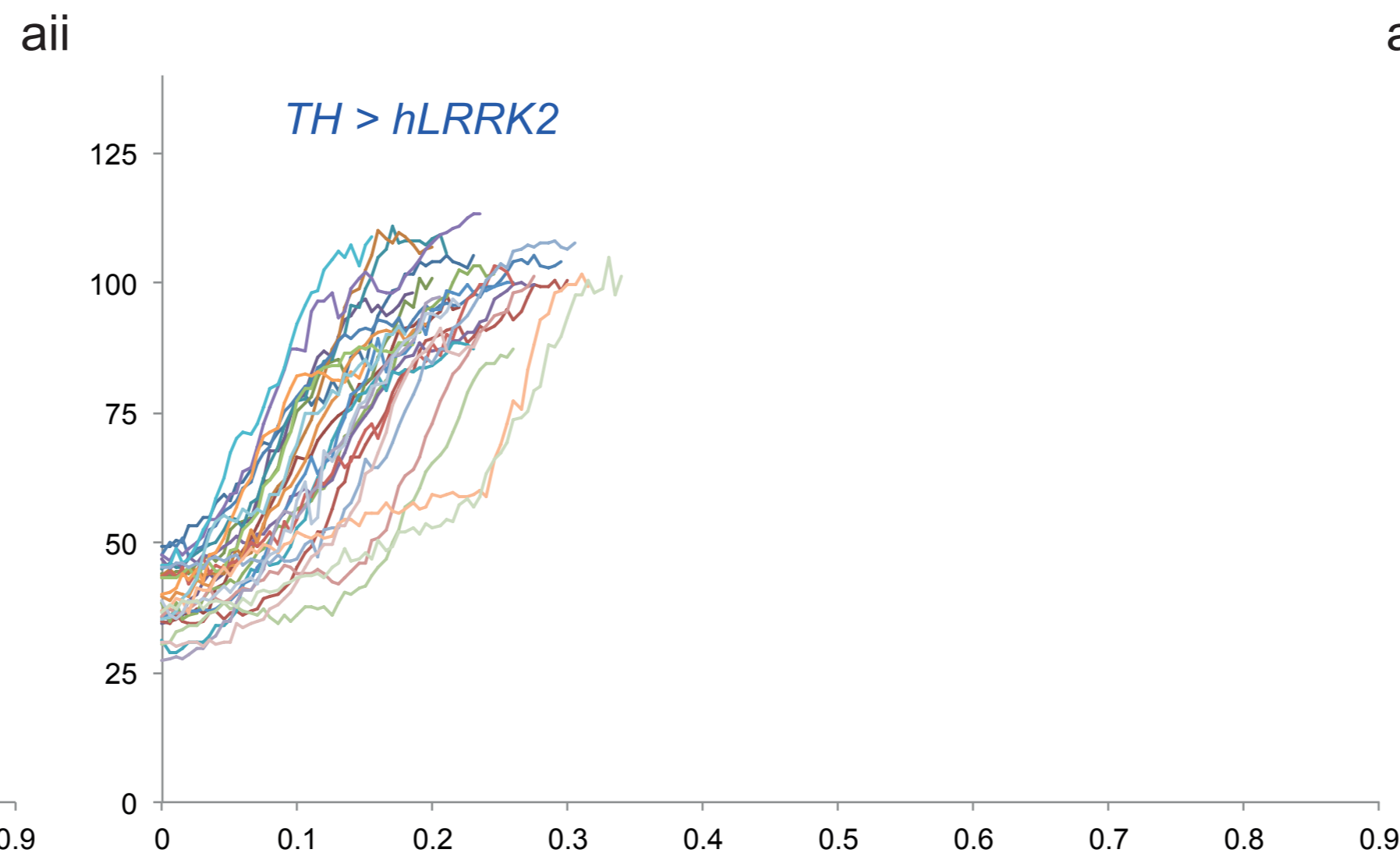
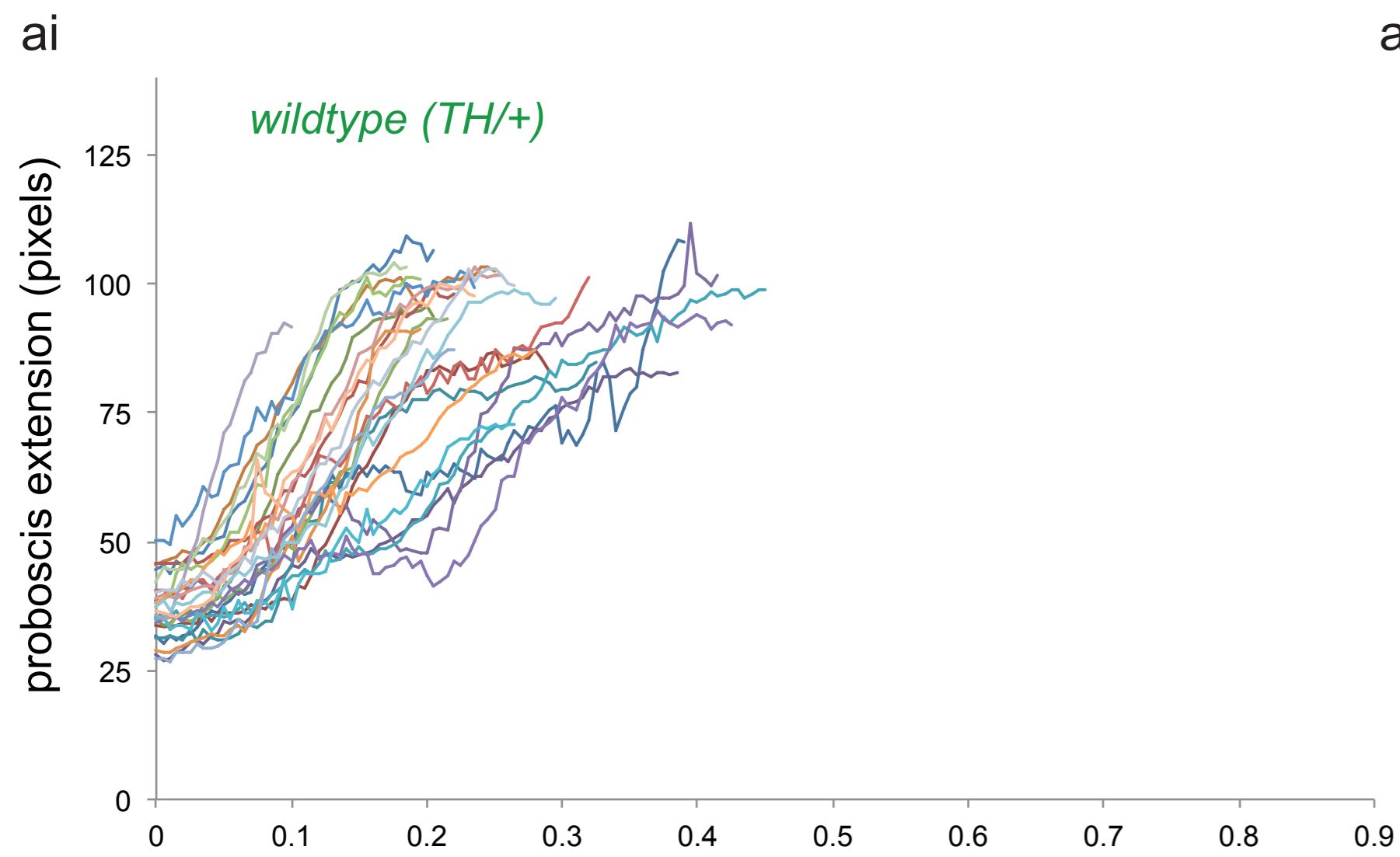

a

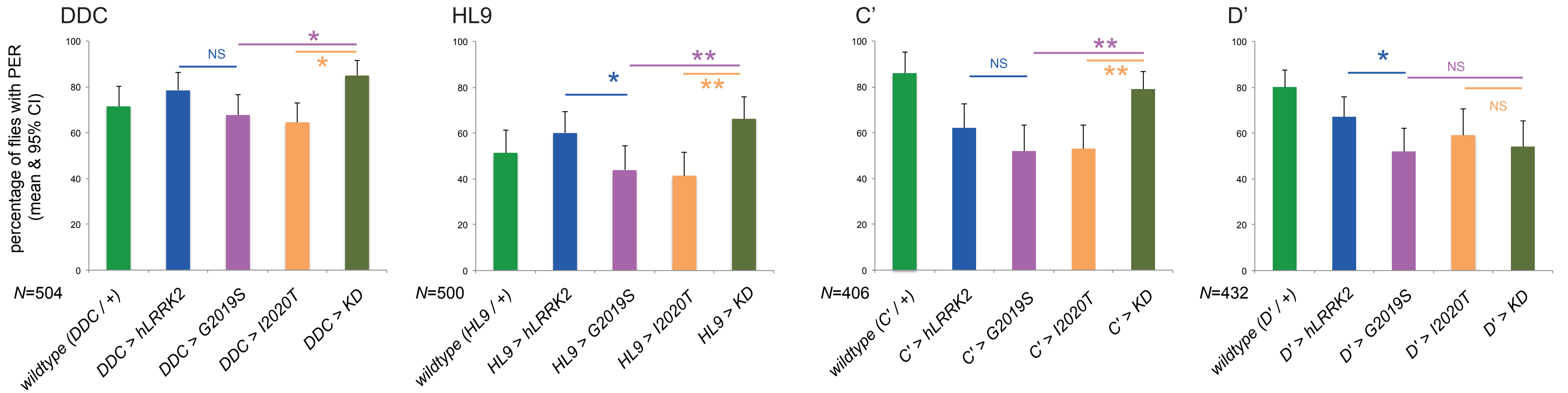

b

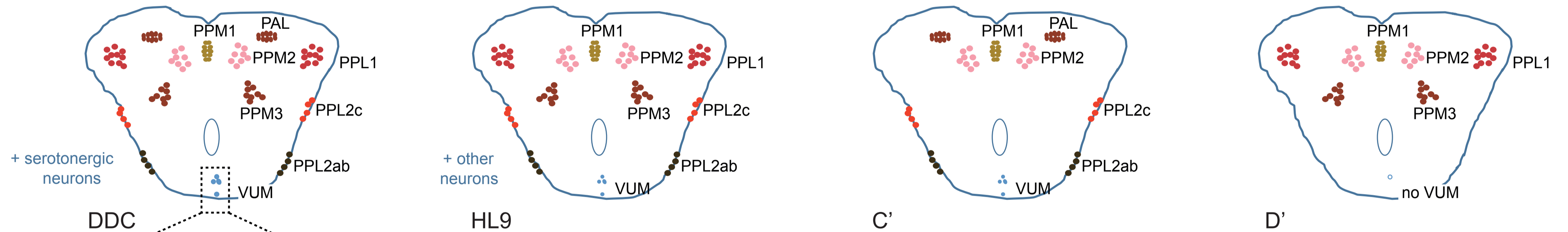

c

