



This is a repository copy of *Oxygen non-stoichiometry, conductivity and gas sensor response of SnO₂ pellets*.

White Rose Research Online URL for this paper:
<http://eprints.whiterose.ac.uk/92550/>

Version: Supplemental Material

Article:

Alagdal, I.A. and West, A.R. (2015) Oxygen non-stoichiometry, conductivity and gas sensor response of SnO₂ pellets. *Journal of Materials Chemistry A*, 3 (46). 23213 -23219. ISSN 2050-7488

<https://doi.org/10.1039/c5ta05818j>

Reuse

Unless indicated otherwise, fulltext items are protected by copyright with all rights reserved. The copyright exception in section 29 of the Copyright, Designs and Patents Act 1988 allows the making of a single copy solely for the purpose of non-commercial research or private study within the limits of fair dealing. The publisher or other rights-holder may allow further reproduction and re-use of this version - refer to the White Rose Research Online record for this item. Where records identify the publisher as the copyright holder, users can verify any specific terms of use on the publisher's website.

Takedown

If you consider content in White Rose Research Online to be in breach of UK law, please notify us by emailing eprints@whiterose.ac.uk including the URL of the record and the reason for the withdrawal request.



eprints@whiterose.ac.uk
<https://eprints.whiterose.ac.uk/>

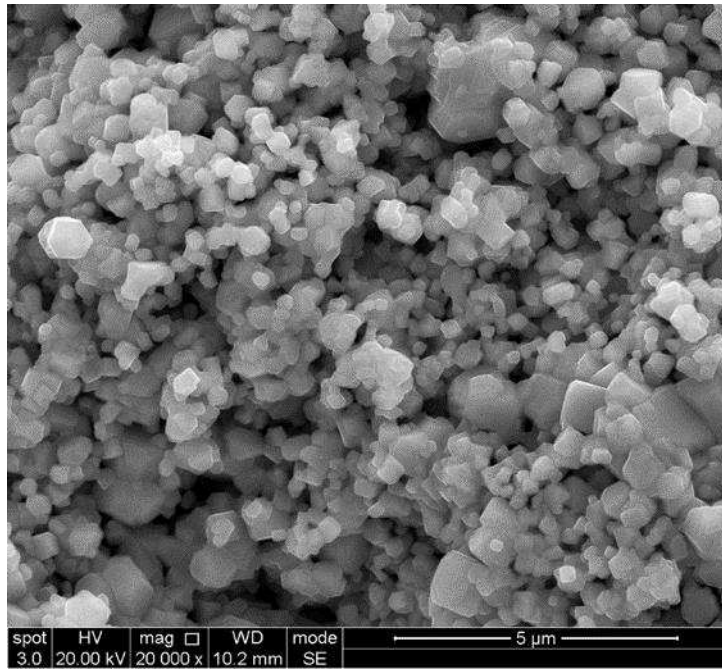

Figure 1

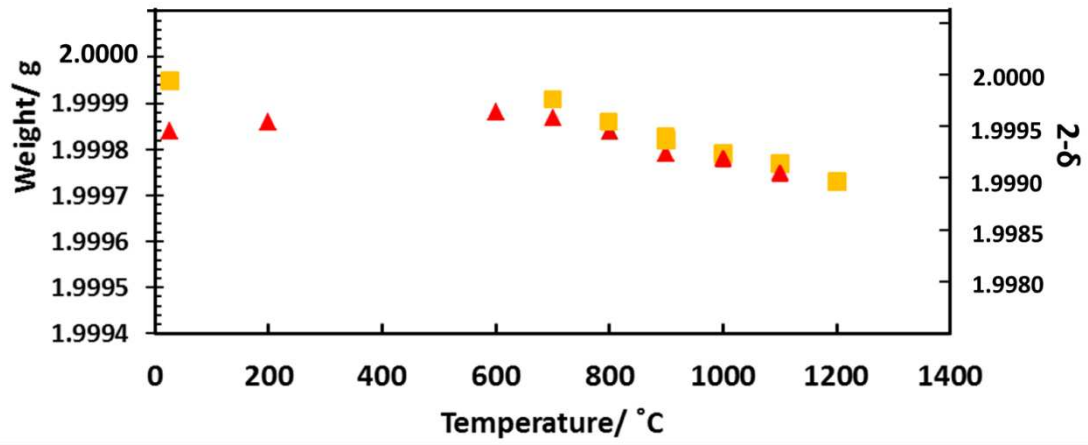

Figure 2

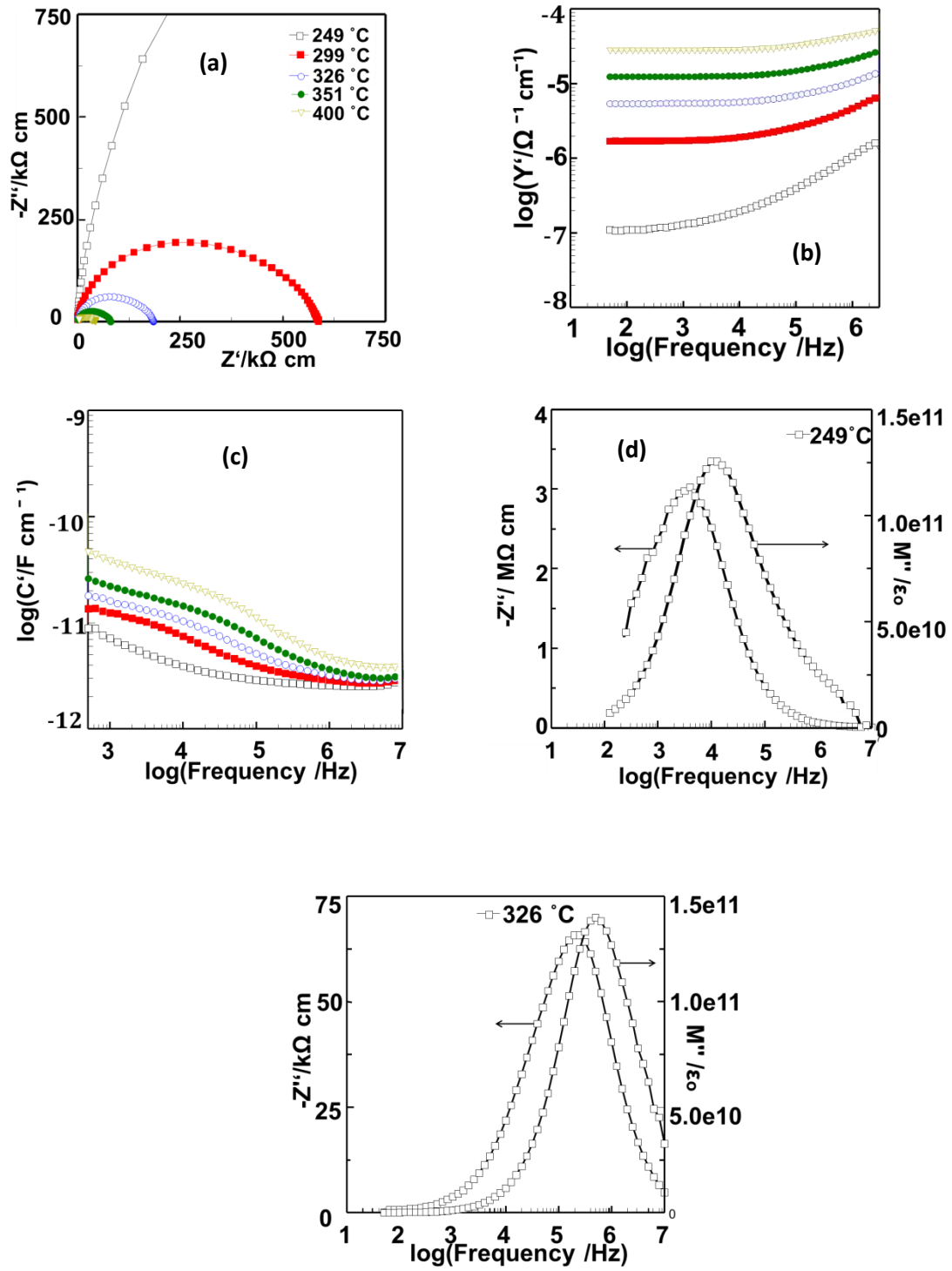

Figure 3

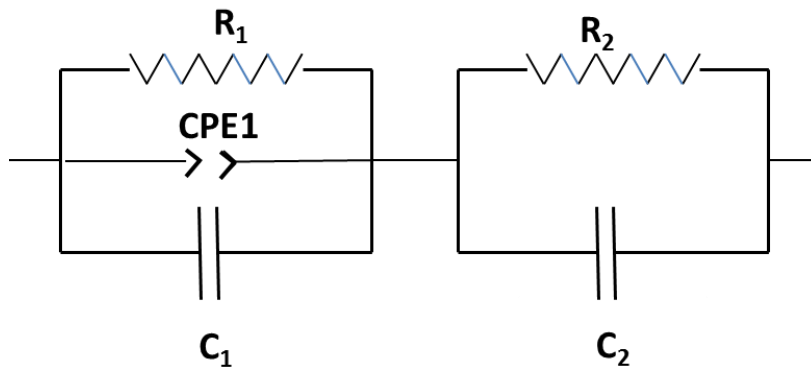

Figure 4

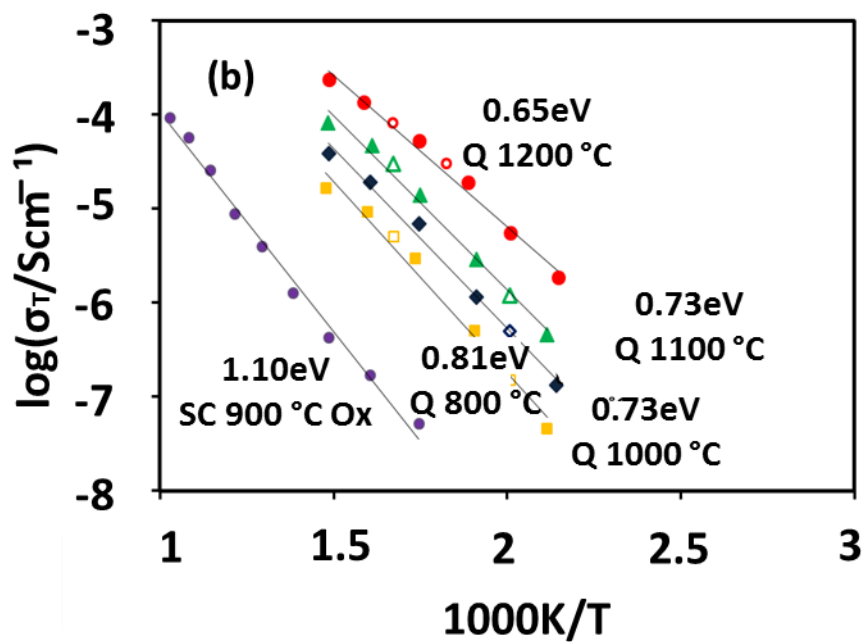
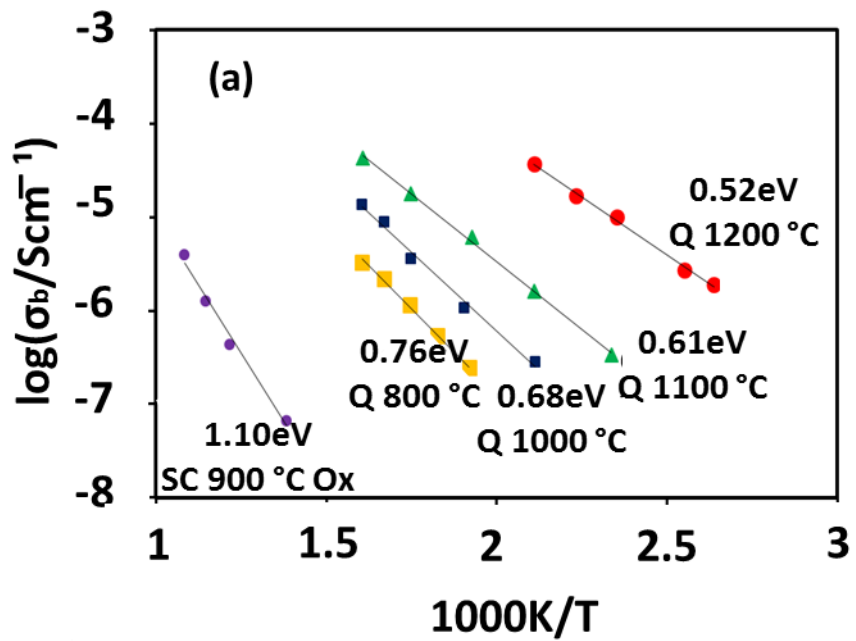

Figure 5

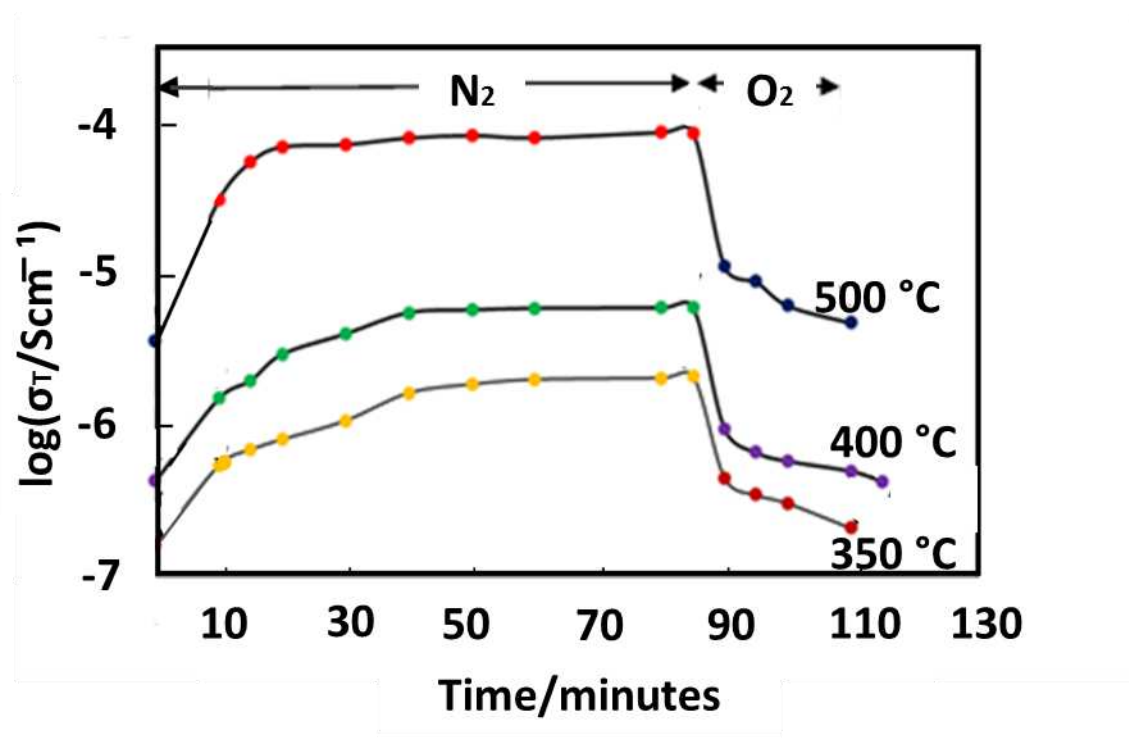

Figure 6

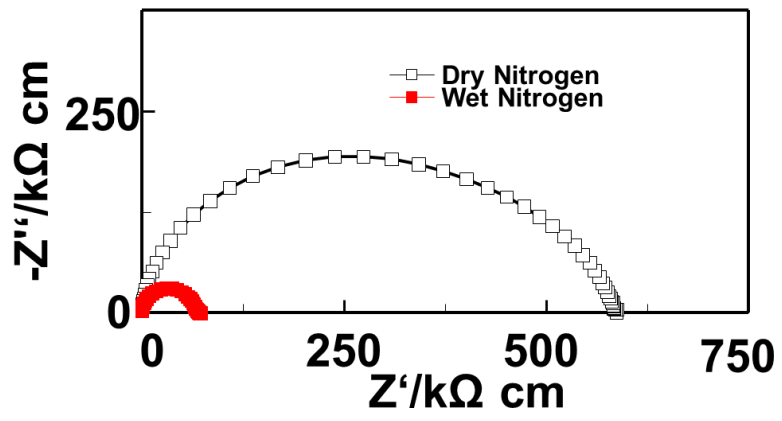

Figure 7

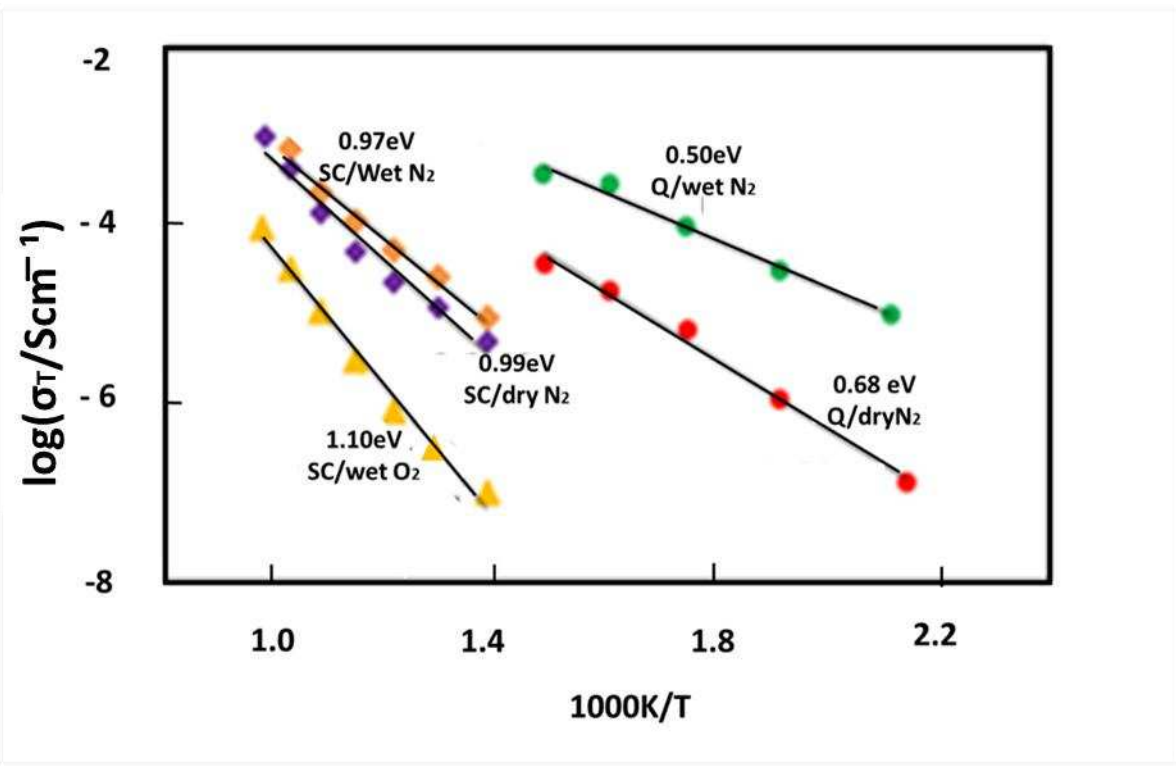

Figure 8

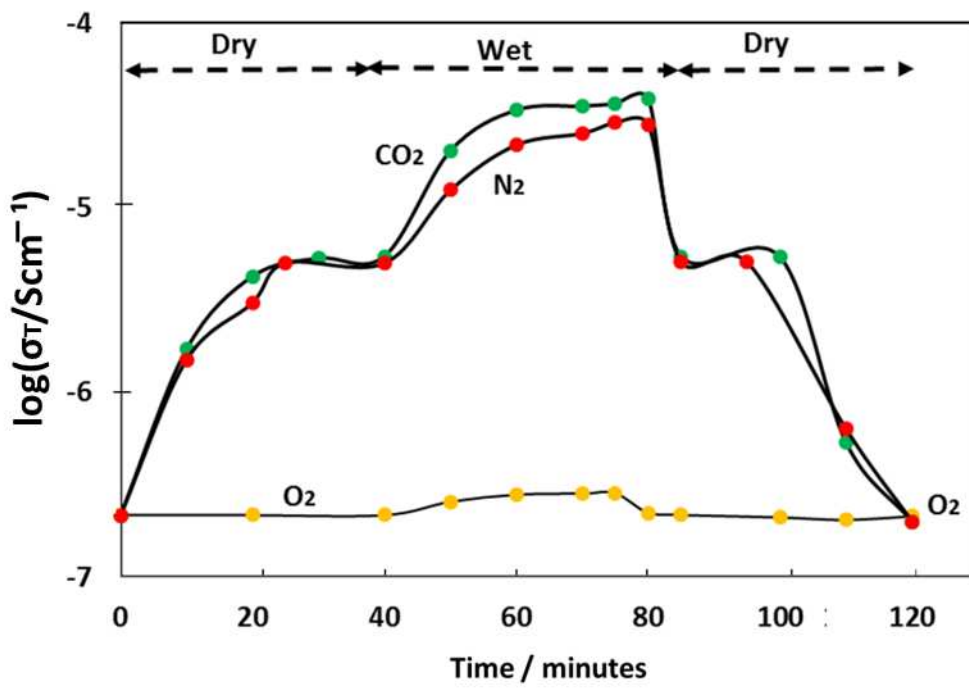

Figure 9