



Deposited via The University of Sheffield.

White Rose Research Online URL for this paper:

<https://eprints.whiterose.ac.uk/id/eprint/758/>

Article:

Tesar, V. (2005) Fluidic Valves for Variable-Configuration Gas Treatment. *Chemical Engineering Research and Design*, 83 (A9). pp. 1111-1121. ISSN: 1744-3563

doi: 10.1205/cherd.04283

Reuse

Items deposited in White Rose Research Online are protected by copyright, with all rights reserved unless indicated otherwise. They may be downloaded and/or printed for private study, or other acts as permitted by national copyright laws. The publisher or other rights holders may allow further reproduction and re-use of the full text version. This is indicated by the licence information on the White Rose Research Online record for the item.

Takedown

If you consider content in White Rose Research Online to be in breach of UK law, please notify us by emailing eprints@whiterose.ac.uk including the URL of the record and the reason for the withdrawal request.

FLUIDIC VALVES FOR VARIABLE-CONFIGURATION GAS TREATMENT

V. TESAR^{*}

Department of Chemical and Process Engineering, The University of Sheffield, UK

The paper surveys recent development in the highly specialized field of chemical engineering: vehicle exhaust gas aftertreatment, where variable configuration systems are currently introduced or considered. These respond to varying operating conditions by inserting into the gas treatment flowpath different reactors. The main practical problem are the valves for gas flow switching. Usual mechanical valves are costly, failure prone, heavy (especially the solenoid variants), and not robust enough to withstand the adverse conditions of high temperature, vibration, shocks and dripping water and mud at the usual locations under vehicle body. Fluidic no-moving-part valves, inexpensive and robust, are proposed as an attractive alternative. Especially in their novel axisymmetric layout, they may be very compact, in fact integral with reactor body. The qualitative change brought by the new approaches may provide an inspiration to other areas of chemical engineering.

Keywords: fluidics; fluidic valves; vehicle emissions; variable configuration.

INTRODUCTION

Exhaust gas aftertreatment in vehicles powered by internal combustion engines is a highly specialized and rather difficult branch of chemical engineering. The requirements present a real challenge. High efficiency of the gas processing reactions is required across an extraordinarily wide spectrum of temperature and flow rate operating conditions and has to be maintained for long periods of time. Design restrictions are demands of low cost, no maintenance, little available space, and adverse conditions of high temperature, vibration, shocks and dripping water and mud at the usual underbody locations. Due to continually decreasing emission limits, current aftertreatment systems have gradually acquired considerable complexity. An interesting development took place recently—a qualitative change brought by adoption no-moving-part fluidic switching valves. The advantages may be an inspiration for analogous uses of fluidics in a wider context of general chemical engineering.

THE PROBLEMS

Increasing public awareness has led to escalating stringency of legal emission limits (c.f. e.g., EPA, 2000). Compliance with the requirements has led to a situation where

emissions became the crucial factor in vehicle development. The completely new solutions, like fuel cell powered cars, less efficient and more expensive, are considered a viable alternative just because of their inherently lower emissions. Improving the emission characteristics of the internal combustion engine itself—by adjusting air/fuel ratio, compression ratio, ignition (or injection) timing, and geometry of combustion space—has already reached a state of hardly any opportunity remaining for significant advances. Currently, before perhaps the fuel cells take over, the leading role in the progress is assumed by aftertreatment—chemical and physico-chemical processing of the emissions (e.g., Eastwood, 2000; König *et al.*, 2001).

Until recently exhaust gas treatment could be performed in a single catalytic reactor. This is no more feasible. Current standard are three or more reactors in the exhaust system. Particularly inevitable are additional reactors for the otherwise attractive lean burning engines (e.g., König *et al.*, 2004). In this case, NO_x can be no more removed by HC and CO as the reducing agents. A separate second reactor with reducing agent injection is therefore used for NO_x removal, commonly accompanied by a third reactor further downstream for oxidation of any reducing agent slip. In addition, a starter reactor near the engine (which reaches operating temperature very fast) is almost always used to suppress the emissions generated in the first minutes after engine start.

Catalytic chemical reactors are nowadays just one of the several device families used or considered for the aftertreatment (Table 1). Removal of some emission components is based on physical and physico-chemical processes such as

^{*}Correspondence to: Professor V. Tesar, Department of Chemical and Process Engineering, University of Sheffield, Mappin Street, Sheffield, S1 3JD, UK.
E-mail: v.tesar@sheffield.ac.uk

adsorption or mechanical filtering. The latter is often used in treating emissions from Diesel engines, a typical example being particle filters for removal of soot carried in the exhaust gas in aerosol form. Adsorption storage (NO_x removal traps) is currently also an often considered alternative. Some proposed solutions combine the reactors with heat exchangers for heating or cooling the processed gas to improve the treatment efficiency.

The increased number of reactors (or devices in general) is mainly due to different requirements posed by individual emission components. The increasing demands of more complete removal can be no more met in simultaneous chemical reactions each requiring different optimum temperature. Another factor is the extremely wide spectrum of operating conditions to be covered. Most chemical reactions as well as the storage processes depend on catalysts, which are efficient only inside a certain temperature range. A reaction cannot be maintained at the same degree of efficiency from the cold start at one end of the spectrum to the high-load high-temperature motorway conditions as the other extreme. Gone are the days of acceptability of compromises which covered reasonably efficient parts of temperature windows for each removed component. Catalysts have to operate nowadays near their efficiency peak temperature. An example of temperature windows for several NO_x removal catalysts is shown in Figure 1 (using information from Engler *et al.*, 1993; Mitsubishi Motors, 1997). Of particular concern is the existence of the upper temperature limits. Apart from the decrease of conversion efficiency, there is a grave danger of irreversible changes: thermal ageing or downright burning out, destruction of the reactor by high temperatures (produced all too easily by the released heat of exothermic reactions).

A solution to the temperature window problem is sometimes sought in using several reactors at different locations along the exhaust duct, where they operate at different temperatures. The temperature distribution along the duct, however, is time dependent and also varies considerably with vehicle use—the extreme being the short, low-load in-town ‘hops’, never reaching the light-off temperature

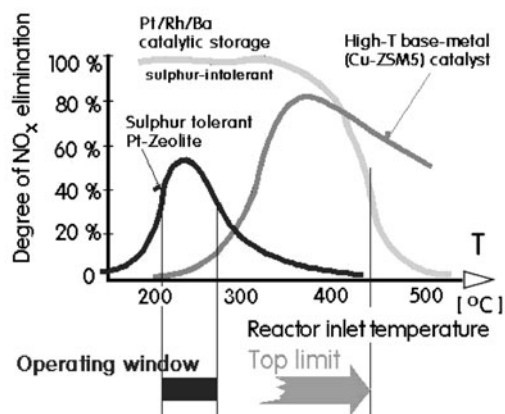

Figure 1. Typical examples of: the temperature window and the top limit of catalytic aftertreatment devices used for NO_x storage and reduction. Due to its sulphur tolerance, Pt-Zeolite catalyst may be the choice despite its narrow, even less than $\Delta T = 100^\circ\text{C}$ temperature window. The upper limits (like the one for Pt/Rh/Ba storage) may be due to loss of conversion efficiency or, more dangerously, due to irreversible thermal changes.

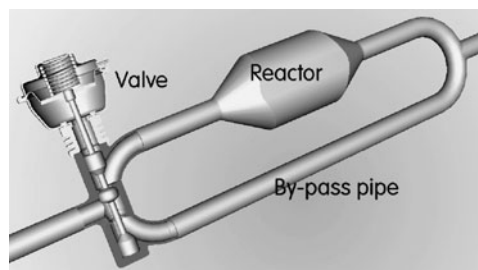

Figure 2. The simplest variable configuration exhaust duct: by-passing a starting reactor to avoid its burn-out.

at which the desired chemical reaction commences. The adjustment of the operating temperatures to the operating window of the catalyst is then only approximate at best. To obtain an almost instantaneous light-off, the reactor may be electrically heated, e.g., during the vehicle start. This, however, is energetically highly inefficient. Much neater is placing the reactor near to the engine. There, however, the temperature may easily reach dangerous levels during long continuous runs. The reactor then may have to be by-passed, as shown in Figure 2, provided its cleansing effect is taken over by another reaction further downstream. This by-passing represents the simplest case of the variable configuration idea.

Characteristic feature of some device types—the adsorber traps and filters—is their accumulation of the emission component removed from exhaust gas. This cannot go on for long; the gradual loss of removal efficiency (and rising pressure drop across the clogged particle filter) calls for periodic regeneration. This may be sometimes—in principle at least—achieved by engine control computer temporarily changing the engine regime. Such an action, however, is not always possible nor, in fact, it would be welcome by the driver as it is associated with sudden sensible changes of engine driving properties. Generally preferable solution is to leave the engine operating at its optimum regime and to change for the duration of the regeneration period the configuration of the aftertreatment system—e.g., so as to generate in the reactor the needed reduction atmosphere.

VARIABLE CONFIGURATION

The reasons that may require a configuration change in various device categories are listed in Table 1. The idea of changing the system configuration according to the instantaneous conditions offers many attractive possibilities, but there is a limit to what is practical, economical—and also what can be actually stowed inside a modern car with its already crammed engine compartments and not much under-floor space either. To provide an indication of the offered opportunities, two variable configuration cases are here presented. These examples involve the basic catalytic reactors and the configuration changes belong to the class of less complex alternatives.

A welcome wider effective width of the temperature window may be obtained by using several different catalysts—differing in their light-off temperature. Catalysts resistant to high temperature may be used as an admixture in a common single reactor body—but this is rarely the case.

Table 1. List of used aftertreatment devices and their reasons for varying the system configuration.

| Device | Reason for configuration changes |
|-------------------------------|----------------------------------|
| Oxidation catalytic reactor | Temperature window limitations |
| Reduction catalytic reactor | Temperature window limitations |
| Adsorber NO _x trap | Regeneration |
| Particle filter | Removal of captured particles |
| Cooler, heat exchanger | Temperature window adjustment |

A lower light-off limit usually leads to reaching unacceptably high temperature levels during a long high-load run. It is therefore advisable to switch the gas flow into the high-temperature reactor B—perhaps according to the parallel layout (1) in Figure 3. In fact, more effective than this obvious solution is the sequentially by-passed series-connected reactor layout (2). The reactor A nearer to the engine operates immediately after engine start and heats the gas so that the reactor B becomes also effective, at least to a certain degree. Also, the efficiency minimum between the two peaks is filled in the layout (2) when A is switched off to avoid its burn-out.

A more complex case of applying the variable configuration concept is shown in Figure 4. There are two by-pass loops and two associated valves for flow switching. The layout widens the effective width of temperature window of the main reactor located downstream from both by-pass loops. Figure 5 shows that the variable configuration keeps the main reactor catalyst at the temperature range securing good emission removal between $\sim 300^{\circ}\text{C}$ and $\sim 380^{\circ}\text{C}$. At lower engine exit temperatures, the exhaust

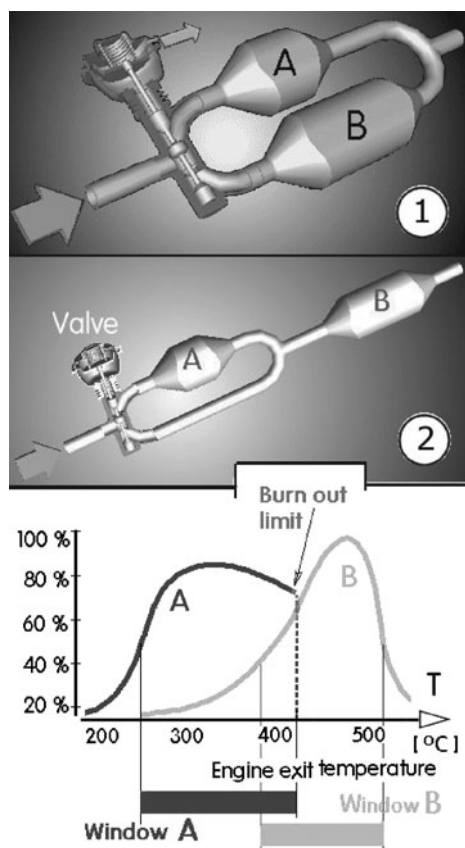

Figure 3. Achieving a wide effective resultant operating temperature window by using two catalysts in two separate catalytic reactors, A and B.

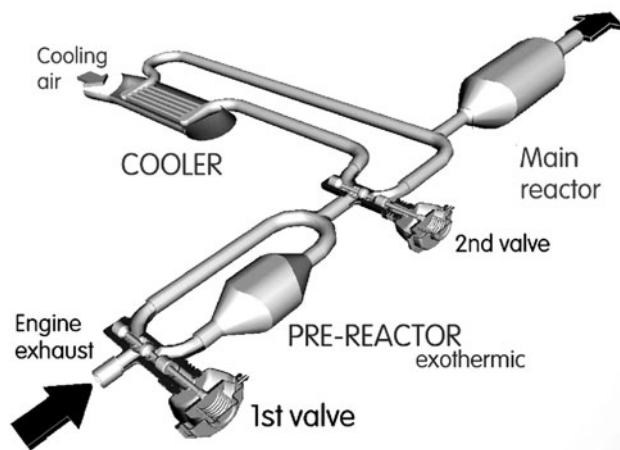

Figure 4. An example of a three-state aftertreatment system with adjustment of operating conditions in the main reactor by either heating in the pre-reactor or cooling. The two temperature adjusting devices are used alternatively—and may be not used at all, in the third direct-flow operational state.

gas is heated in the upstream oxidizing catalytic pre-reactor, with catalyst selected for a particularly low light-off temperature. Its main task is to rise the temperature by about $\Delta T \sim 100^{\circ}\text{C}$ by the exothermic reaction. The additional effect of oxidising CO and HC in the pre-reactor is welcome, but not essential so that the pre-reactor may be by-passed at high engine exit temperature levels. If, on the other hand, the temperature at the main reactor inlet is above the top limit of the operating window, the exhaust gas is cooled by up to $\Delta T \sim -170^{\circ}\text{C}$ in the cooler and in the long pipes leading to it (while the by-pass branch leading directly to the main reactor is short).

In the NO_x storage case, the proposed variations of the system configuration for the regeneration are usually of the simple by-pass type, corresponding to Figure 2 above. The switching is not complete: the main flow of the exhaust gas, too rich in oxidant, is diverted into the by-pass pipe, but a part of it is left to enter the reactor matrix forming there the reducing atmosphere—usually enriched by additional fuel. Addition of other reactants is often considered, but availability of the engine fuel makes it a

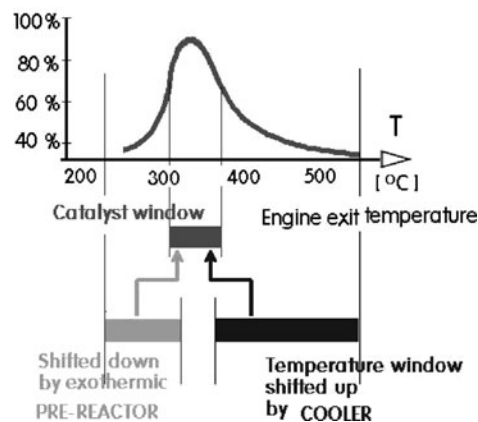

Figure 5. The three operating regimes obtainable in the aftertreatment system shown in Figure 4. Switching the flow into the cooler or into the pre-reactor shifts the exhaust gas temperature to fit the rather narrow operating window of the main reactor catalyst.

strong candidate. The required higher temperature is easily achieved in the reduced remaining gas flow rate through the matrix.

THE CRITICAL COMPONENTS: VALVES

The obvious disadvantage of all valuable configurations is their increased complexity. Also the larger occupied space tends to be a negative factor. Complexity generally translates into higher resultant vehicle cost and also potentially higher occurrence of breakdowns. In fact, the gas processing reactors, filters and storage devices themselves are reliable and their breakdowns rare. After all, their increasing number is a common trend in contemporary aftertreatment. Also the interconnecting pipes are relatively inexpensive. When potential problem areas are analysed, invariably at the root of all the drawbacks are found the valves required for the switching.

Figure 6 presents an example of a current exhaust gas switching valve design based on experience with exhaust gas recirculation valves, scaled up to handle the whole exhaust gas flow and re-arranged to provide the diverting rather than turning-down action. The conditions under which these valves would operate are adverse to the extreme: there is high temperature, vibration, shocks, and the dripping water as already mentioned. These valves are made from a number of parts, several of them machined (there are several precision requirements difficult to meet without machining). They have then to be assembled—and assembly operations are generally costly. What makes the valves such as the one shown in Figure 6 the most annoying parts of the system is, however, the non-negligible possibility of their malfunctions. Vehicles have to be simple and robust, operated for years without maintenance in the hands of drivers tending—more often than

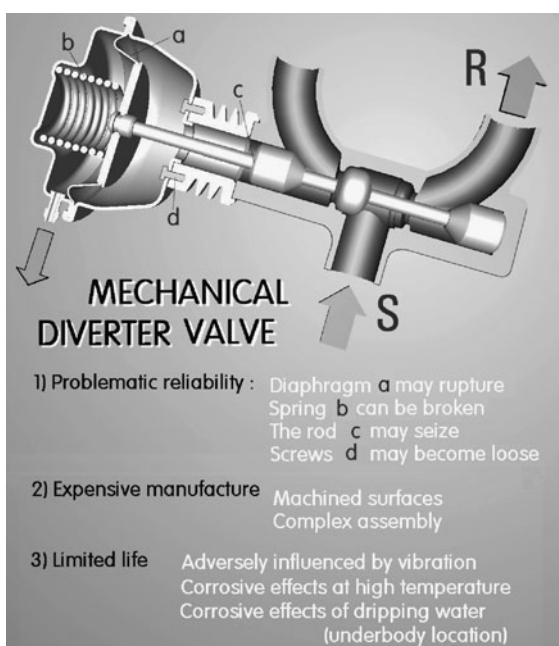

Figure 6. An example of typical mechanical valve currently considered for the variable configuration aftertreatment systems—and its disadvantages, making it the weakest link in existing proposals.

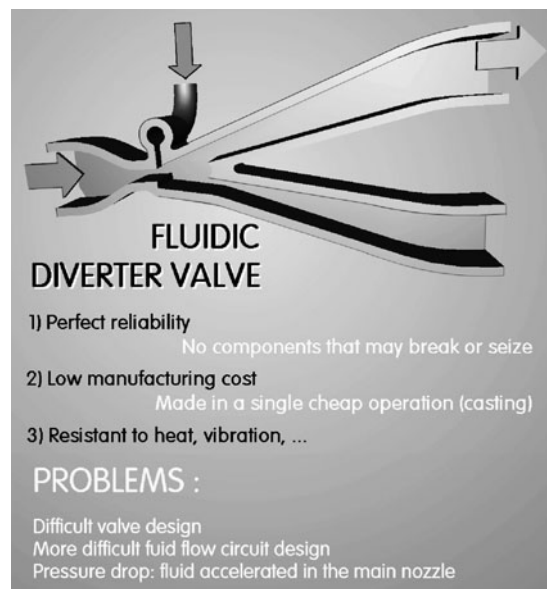

Figure 7. An example of standard planar no-moving-part fluidic valve, its advantages and problem areas.

not—to be negligent. Valves as additional components, with diaphragm prone to rupture, springs that may break, and other details lacking the full 100% reliability may degrade the vehicle.

Fortunately, a solution has been there, though largely unrecognized. It is the use of no-moving-part fluidics (Priestman and Tippetts, 1984; Tesař, 1998a, 2004). Instead of by placing a mechanical obstacle into the flowpath, the fluidic valves direct the flow into the desired outlet by utilising the inertia of fluid jet, accelerated in a nozzle. The flow control is achieved by deflecting the jet, usually by another, small control flow issuing from a perpendicular control nozzle.

There are no diaphragms that may rupture, no springs that may break, and (in the actual valve at least – they may be needed in the pipe connection flanges) no screws that may become loose. The fluidic valve (Figure 7) is essentially a solid robust outer case with an empty space inside—so that there is nothing adversely influenced by high temperature, vibration, shocks or the dripping water and mud. Fluidic valves are often made as a single component manufactured in a single operation, such as casting. There are no assembly operations and often no machining (apart perhaps from the end flanges where the valve comes into contacts with the other components of the exhaust system). Fluidic valves are inexpensive and yet robust, requiring absolutely no maintenance and exhibiting practically unlimited operating life. Of importance for the discussed application is their eminent resistance to high temperature (Perera and Syred, 1983, Tesař, 1994).

OPERATING PRINCIPLES OF FLUIDIC VALVES

A number of various aerodynamic phenomena are used, tested, or proposed for use in fluidic valves. Essentially, the flowfield generated in the valve has to possess a 'weak spot' in which a small control action can result in a substantial change of the whole flow. In the present paper, the

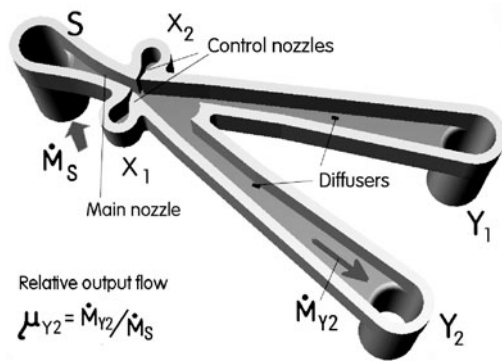

Figure 8. An example of a bistable no-moving-part fluidic valve. In the absence of moving mechanical components, the gas flow accelerated in the main nozzle is forced into the desired output by its inertia. To avoid excessive hydraulic losses, the flow has to be slowed down in diffusers.

discussed valve designs are based on formation of a jet, employing aerodynamic mechanisms leading to bistability or monostability—the capability to remain in one of the two flow diverting states without the control flow (Tesař, 1997a, b).

Typical mechanical valve shown in Figure 6 is controlled by vacuum acting on the diaphragm **a** in the state diverting the gas flow from S to R. The other state is maintained without control action, by the force of the spring **b**. The flow control effect is roughly proportional to the exerted control pressure. A control flow is required (and control power consumed) only during the switching.

In a fluidic valve, an example of which is shown in Figure 7, the gas jet is deflected into the desired outlet by the action of control flow. However weak, a constant control action would permanently consume a certain control power, decreasing the overall energetic efficiency of the vehicle. This may be avoided by using the Coanda effect of jet attachment (e.g., Perera and Syred, 1983). A wall placed at one side of the jet prevents replacement of fluid entrained and carried away the jet. This creates low pressure between the wall and the jet, which is curved towards the wall and attaches to it, leaving the wall at a direction different from the direction of the nozzle exit.

With two such attachment walls, a bistable fluidic valve (e.g., Tesař, 1998a) with two stable states is made, each

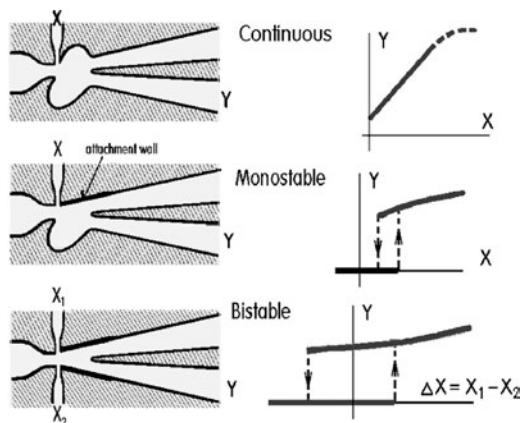

Figure 9. Basic variants of jet deflection valves and their transfer characteristics: dependences of the output effect Y on the control action X obtained by presence or absence of the attachment walls.

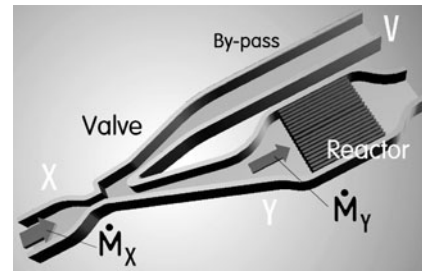

Figure 10. Monostable fluidic diverter valve with the reactor in its preferential output branch. Flow is switched into the by-pass when the increased reactor temperature moves the intersection on the loading characteristics (Figure 16) to the load-switching point.

leading the fluid flow into a different output, Figure 8. The necessity of having not only two control nozzles but also two associated control circuits is an unpleasant complication. Less known asymmetric monostable variants (Figures 7 and 9) were developed by the present author (Tesař, 1997a).

In an interesting version of the valves applied to reactor overheat protection, the valve needs no control circuits at all (Tesař, 1994). A monostable diverter has the reactor connected to its preferential collector, Figure 10. When reactor dissipation (aerodynamic resistance) increases, due to increasing gas viscosity with rising temperature (and hence increasing friction), to a pre-set level the flow is switched into the by-pass. This load-switching phenomenon is due to the Coanda effect failing to keep the jet attached to the main attachment wall when the blockage by the load is too high.

Despite the elegance of this passive control, after an initial enthusiasm it was not accepted by the customer for whom it was developed (Volkswagen A.G.). The designers of the engine control system preferred its having a direct authority over the switching. Admittedly, relying on the aerodynamic properties of the reactor matrix and its manufacturing tolerances may adversely influence reproducibility, which a closed feedback loop control mode avoids. The author was asked for a re-designed controlled valve. This is obtained by stabilizing the attachment (operation range far from the load-switching state) and providing control nozzles overriding the attachment. Control actions needed in the bistable case are just short flow pulses moving the main jet from one attachment wall to the opposite one—as shown in the switching sequence A to D in Figures 11 to 15. In the planar symmetric bistable valve

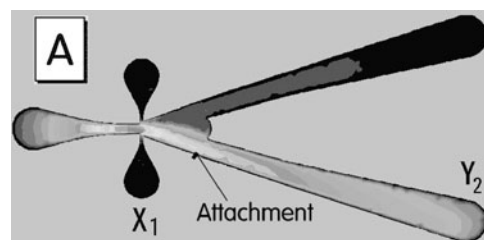

Figure 11. Computed contours of absolute velocity in the bistable valve from Figure 9 in absence of control flow. The jet is attached to the bottom attachment wall guiding it to the output terminal Y₂. The advantage of the attachment is savings in the control power otherwise required in jet-deflection valves to keep the gas jet deflected.

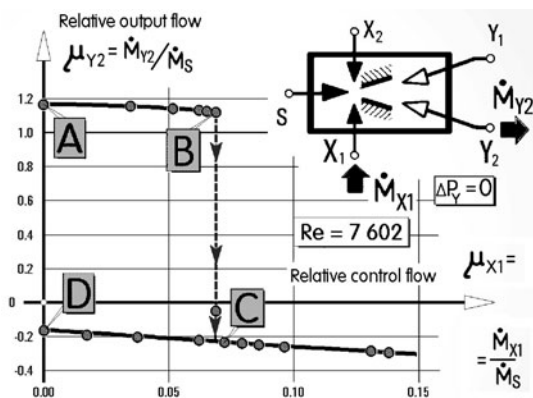

Figure 12. Schematic diagram of the bistable valve in Figure 11 and the hysteresis loop in its flow transfer characteristics—dependence of relative output flow μ_{Y2} (related to the supply flow rate) in terminal Y_2 on the relative control flow μ_{X1} in terminal X_1 .

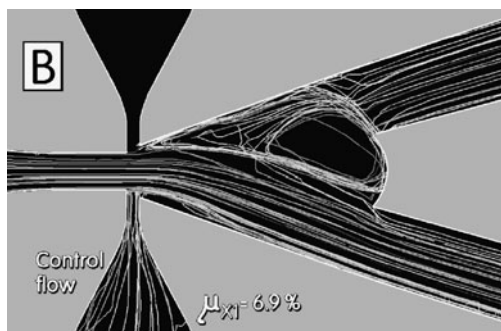

Figure 13. Computed pathlines inside the bistable valve in the state B of Figure 12, with control flow insufficient for switching the main flow, held by Coanda effect and the negative feedback effect of the flow turned back by the splitter tip.

example, Figures 8 and 11, a cut-out on the ‘bi-cuspid’ splitter nose between the two collectors provide an additional stabilizing negative feedback effect (Figure 13). The bistability prevents the main jet from returning into its original nozzle exit direction after the control flows return to zero (Figure 15). Another switching

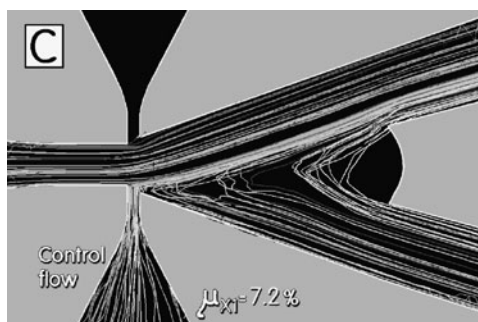

Figure 14. Pathlines inside the valve in the state C of Figure 12. The increased control flow overcame the Coanda effect as well as the negative feedback and has just switched the main flow towards the opposite attachment wall, which leads it into the other output terminal.

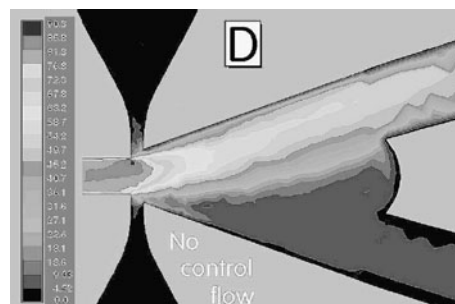

Figure 15. Computed contours of absolute velocity in the interaction cavity of the bistable valve in the state D (Figure 12). Despite the decrease of the control flow to zero, the main jet remains attached to the wall towards which it was pushed by the previous control action shown in Figure 14.

flow control pulse from the opposing control nozzle is necessary to restore the initial state (from D to A).

The monostable alternative (Figure 9) is simpler to control, with single control nozzle and single control circuit (rather than two serving the two control nozzles of the bistable valve). Disadvantage is the need of a permanent control flow in one of the states. Monostable valves are attractive for applications in which diverting the flow into the by-pass is required for only a limited period of time—as is usually the case when regenerating a storage devices (particle filter or NO_x adsorber)—so that the valve operates without the control flow for most of the time.

CRITICAL ROLE OF DIFFUSERS

Fluidic valves offer convincing advantages but are difficult to design. The operation by clever use of internal aerodynamic phenomena means that designing the geometry much more challenging than in the mechanical valve case. Moreover, the whole exhaust system is more difficult to design with fluidics. In the absence of a solid obstacle forcing the fluid flow into the required outlet, the operation of fluidic valve may vary considerable with changes in pressure and flow conditions.

The main problem is keeping pressure losses low. More or less proportional to the square of flow velocity, they tend to be high in a device requiring acceleration of flow in the nozzle to form the jet—unless the collector capturing the jet is placed near to the nozzle exit (which makes deflecting the jet more difficult) and contains a diffuser re-converting the gas kinetic energy into the pressure. In fact—as shown in the schematic circuit representations in Figure 16—it is basically the pressure recovered in the valve diffuser which drives all the flow through the reactor. Diffusers achieving good pressure recovery tend to be long. This is one of the Achilles’ heels of most fluidic valves considered so far: occupying much of the precious available volume in the vehicle. Utilizing whatever space is available may necessitate bending the diffuser axis—with detrimental effects on the efficiency. The problem of designing high pressure recovery diffusers is aggravated by the specific operating conditions in IC engine exit—strong flow pulsation and possible accretion of contaminants from the exhaust gas.

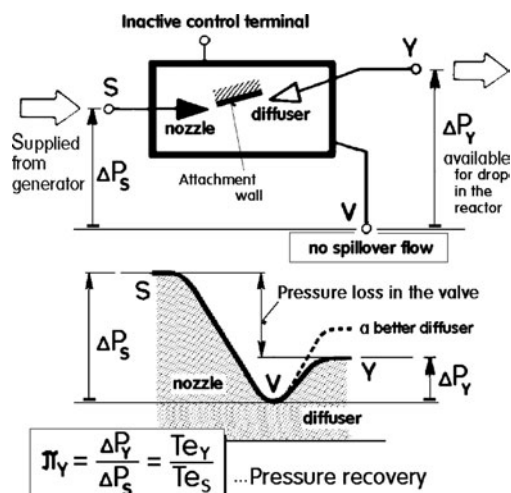

Figure 16. Schematic representation of the valve and the pressure distribution along the fluid flow paths in the no-spillover regime. The pressure drop driving the flow through the reactor is the pressure recovered in the diffuser.

MATCHING

The often worse than desirable pressure recovery results in hydraulic losses, not welcome by engine designers. Engine efficiency decreases with increasing back pressure, already higher than desirable due to the presence of the reactors themselves. A solution might seem to be in making the valve large, with large flowpath cross sections to keep the pressure loss down. Unfortunately, this is not an acceptable choice. Not only the problem of fitting the larger valve in the vehicle would be made worse. More

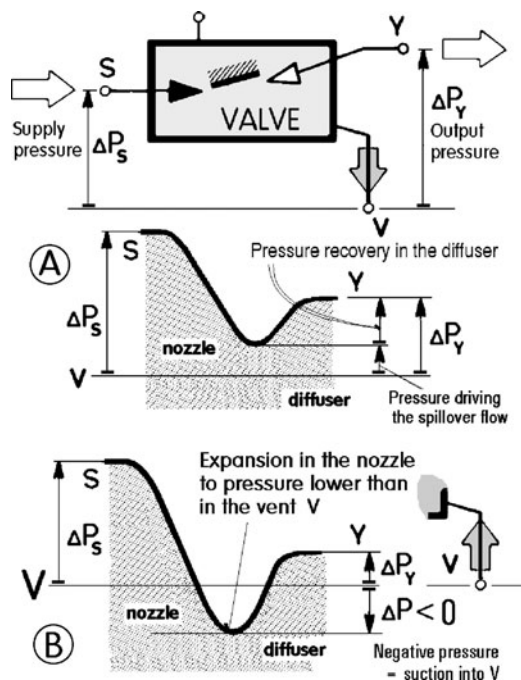

Figure 17. With improperly adjusted load some gas flow is spilled over (A) or re-circulated (B). The latter case (c.f. Figure 18) is harmless—in fact the repeated passage through the reactor may cleanse the gas better—but wastes the painstakingly achieved diffuser pressure recovery.

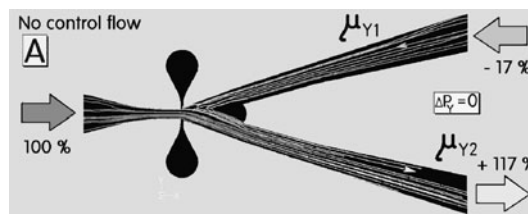

Figure 18. Computed pathlines in the zero control flow state A (c.f. Figures 11 and 12) at zero pressure difference between the output terminals (no connected load). Note the 17% flow recirculation due to the jet-pumping effect of the main jet.

importantly, for controllability and transfer of fluid power, the size of the valve cannot be chosen arbitrarily and has to match that of the reactor.

Essential part—far from simple—of fluidic valve design is its matching to other exhaust system components. The valve has to meet the *no-spillover* condition or at least be operated very near to this ideal regime, shown in the schematic representation of the fluidic circuit in Figure 16. If the valve is larger, the pressure conditions would correspond to the case (A) in Figure 17. The pressure changes in the valve would be smaller and indeed the valve pressure loss—between the terminals S and Y—would be lower. But the blockage effect of the reactor would drive the exhaust gas to spilling over into the by-pass. This is not acceptable as the spilled over part of the flow would escape the cleansing,

Some spillover is accepted in the passive valve of Figure 10 as the intersection point of the characteristics in Figure 19 moves with increasing gas temperature towards the load-switching point. This, however, is due to the exceptional situation: there is a second reactor further downstream prepared for taking over the cleansing when the load-switching takes place.

More harmless may seem to be adjusting the conditions according to the case (B) in Figure 17, with recirculation rather than spillover flow. The computation in the example in Figure 18 demonstrates that the jet-pumping effect of the main jet in the fluidic valve is capable of producing the return flow through the by-pass. However, this is equivalent to choice of a smaller valve, operating with higher

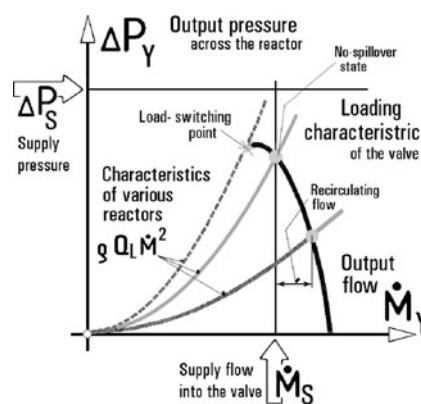

Figure 19. Schematic example of typical fluidic diverter valve loading characteristic at zero control flow—dependence of the available output pressure on the output flow rate delivered into the reactor. Intersections with the superimposed characteristics of the reactor determine the magnitude of the jet-pumping recirculation, Figure 17.

pressure differences and higher overall pressure loss in the valve—the very opposite to what is desirable.

Solution of the matching task is complicated by the intricacy of characteristics of real reactors and fluidic valves. Their properties are usually very much influenced by the subquadratic friction (Tesař, 1998b)—though not enough for their properties being well represented as linear. For a simple model of the behaviour, the best approximation to reality is quadratic constitutive relation

$$\Delta P = \rho Q \dot{M}^2 \quad (1)$$

with device properties characterised by value of the quadratic dissipation Q [m^2kg^2] (Tesař, 1976). Loading properties of the valve are actually governed by complex mechanism of the pressure rise in the diffuser. For simplicity of the description, the loading characteristic (Figure 19) may be approximated by the quadratic model presented in Figure 20:

$$\Delta P_Y = \Delta P_a - \rho Q_S \dot{M}_Y^2 \quad (2)$$

The parameter ΔP_a in this model is proportional to the supply pressure ΔP_S of the flow into the valve main nozzle, but also increases with improvement of diffuser efficiency. The output dissipation Q_S of the valve is inversely proportional to the square of its characteristic cross section A_{valve} , though it also involves the effects of the friction in the diffuser.

The operating conditions in the fluidic circuit schematically shown in Figure 21 are determined by intersection in Figure 19 of the modelled loading curve described by equation (2) with the characteristic of the reactor, which may be also assumed to be dominated by quadratic properties according to equation (1), so that

$$\Delta P_Y = \rho Q_L \dot{M}_Y^2 \quad (3)$$

Again, the load quadratic dissipation Q_L characterising hydraulic properties of the reactor is inversely proportional to the square of the characteristic cross sectional area (sum of all passages) A_{reactor} .

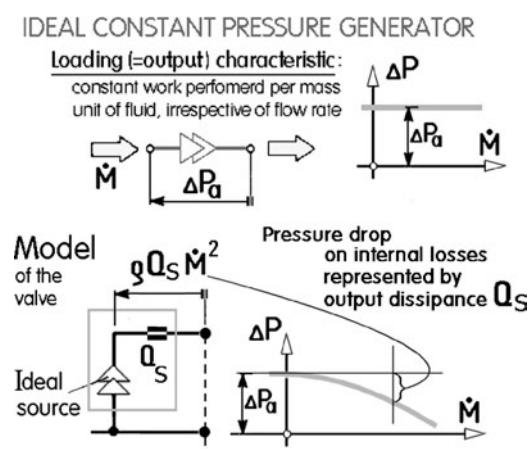

Figure 20. Ideal pressure generator modeling the pressure rise in the valve collector and use of this concept to model the loading characteristic.

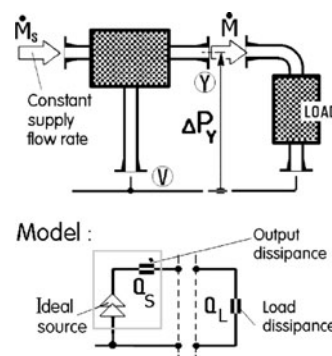

Figure 21. Schematic representation of loading the valve by the connected reactor, again assuming—for simplicity—quadratic behaviour of the load.

It is useful to introduce the maximum valve output flow rate $\dot{M}_{Y\text{max}}$, achieved at zero pressure difference between the valve outlet terminals $\Delta P_Y = 0$, when equation (2) reduces to

$$\Delta P_a = \rho Q_L \dot{M}_{Y\text{max}}^2 \quad (4)$$

In its general form, equation (2) may be then re-written, using equation (4), as

$$\Delta P_Y = \rho Q_S \dot{M}_{Y\text{max}}^2 - \rho Q_S \dot{M}_Y^2 \quad (5)$$

It is also useful to introduce dimensionless loading parameter Te_L similar to the Tesař number pressure parameter Te_Y used for characterisation of diffusers e.g., in equation (14) on p. 405 in Tesař, 2004—but differing in relating the pressure rise ΔP_Y to the maximum theoretical flow rate $\dot{M}_{Y\text{max}}$, instead of to the actual flow (or to the supply flow rate as defined in another alternative of this useful pressure parameter in equation (2) on p. 717 in Tesař *et al.*, 2004). Multiplying Te_L by relative flow μ introduced as

$$\mu = \dot{M}_Y / \dot{M}_{Y\text{max}} \quad (6)$$

leads to expression having the meaning of dimensionless power available at the output of the valve

$$Te_L \mu = B \frac{\Delta P_Y}{\dot{M}_{Y\text{max}}} \mu \quad (7)$$

where B is a constant of the particular combination of the valve and the working fluid (gas). Inserting equation (5) into the expression for Te_L in equation (7) results in the dimensionless power written as

$$Te_L \mu = B \rho Q_S \dot{M}_{Y\text{max}} \mu (1 - \mu^2) \quad (8)$$

The valve is optimally matched to the reactor if the transferred hydraulic power reaches the maximum, i.e., when

$$d(Te_L \mu) / d\mu = B \rho Q_S \dot{M}_{Y\text{max}} \mu (1 - 3\mu^2) = 0 \quad (9)$$

This is satisfied for the optimum value of the relative output flow rate

$$\mu_{\text{opt}} = \frac{1}{\sqrt{3}} \tag{10}$$

In the intersection (similar as in Figure 19) of the modelled valve loading characteristic and the characteristic of the reactor, the pressure ΔP_Y expressed from equation (3) and equation (5) must be equal:

$$Q_L \dot{M}_Y = Q_S \dot{M}_{Y^2 \text{max}} - Q_S \dot{M}_Y^2 \tag{11}$$

which leads to the mutual relation between the relative mass flow rate μ and the ratio of the reactor dissipation to the output dissipation of the valve

$$q = Q_L/Q_S = (1 - \mu^2)/\mu \tag{12}$$

Inserting the optimum condition equation (10) into equation (12) shows that the maximum value $Te_{L\text{max}}$ of the power transfer coefficient is obtained with relative dissipation of the load

$$q = 2 \tag{13}$$

Accepting the extremely simplifying assumption of other factors being equal,

$$q \approx (A_{\text{valve}}/A_{\text{reactor}})^2 \tag{14}$$

which means that as the very rough rule of thumb guidance, the optimum valve cross section is to be $\sqrt{2}$ -times the total cross section of the flowpaths in the reactor. Making the valve either larger or smaller deteriorates the performance. This is well seen in the diagram in Figure 22, which presents as a function of the relative flow μ the values of Te_L relative to the attainable maximum

$$\frac{Te_L}{Te_{L\text{max}}} = \frac{q}{2} \left(\frac{3}{1+q} \right)^{3/2} \tag{15}$$

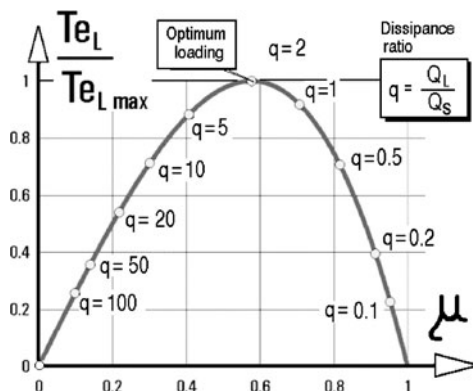

Figure 22. Relative value of the power transfer parameter Te_L as a function of relative output flow rate μ : quadratically behaving model of the valve is optimally loaded if the dissipation of quadratic load Q_L is twice the dissipation Q_S representing the internal losses in the valve.

Figure 22 shows how the theoretical optimum is approached with different relative loads q . Fortunately, the top of the curve is flat and the dependence is not too critical. With valve output dissipation Q_S equal to the reactor dissipation Q_L , which may be with some licence interpreted as roughly the same characteristic cross sections in the valve and reactor, it is still possible to transfer nearly 90% of the maximum transferable power.

AXISYMMETRIC VERSIONS

Apart from the Coanda effect, another less well known way how to obtain the bistability is using the captive vortex ring in an axisymmetric configuration, Figure 23. The vortex is held in the semi-toroidal cavity formed opposite to the exit of an annular nozzle at the upstream tip of a tubular body (Tesař and Reisenberger, 1999). Depending on the sense of its rotation, the vortex leads the annular jet either to the outside or into the inner space of the tubular body. This idea—combined with radial version of the Coanda-effect attachment—has led to a very compact axisymmetric version of the load-switched monostable valve (Figure 24) (Tesař, 1997a). The axisymmetric valve can

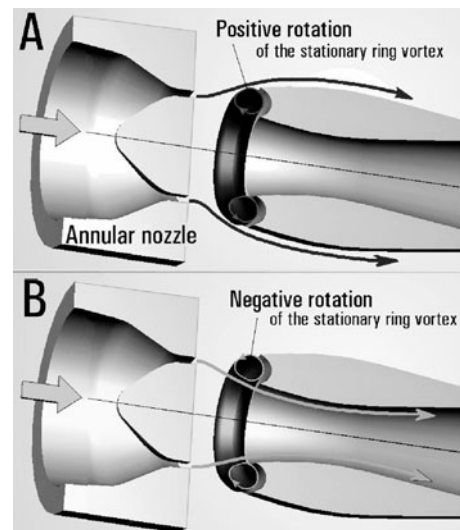

Figure 23. The two stable-state flows past captive vortex ring opposite to an annular nozzle (Tesař and Reisenberger, 1999). The phenomenon assists the Coanda-effect stabilisation of radially switched annular jet in axisymmetric no-moving-part valves.

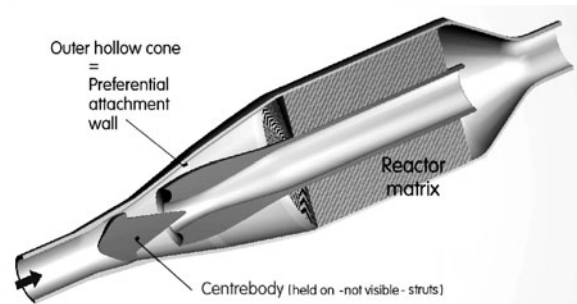

Figure 24. Axisymmetric version of the load-switched by-passing with monostable diverter valve (analogous to Figure 10). Space saving valve is built integrally into the upstream part of the reactor body.

be built as an integral part of the reactor body. The by-pass pipe is placed centrally inside the reactor matrix. This initially caused some resistance on the part of matrix suppliers—but later was found to bring additional advantages—it makes possible desirable heating of the matrix by the by-passed gas during the storage regeneration. In fact, the axisymmetric versions can exhibit higher aerodynamic efficiency, being free from the damping effects of the friction on the bottom and top surfaces of planar valves.

First axisymmetric valves developed by the present author (first description Tesař, 1996; details later in Tesař, 1997a, b) were the passive load-switched versions (Figure 23) using the same principle as shown in

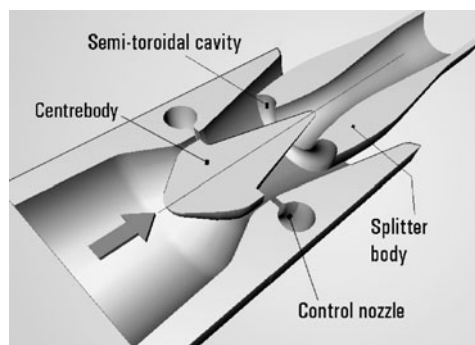

Figure 25. Axisymmetric monostable diverter valve with external control. The vortex-ring stabilization effect (Figures 9 and 10) is combined with radial Coanda attachment to conical surfaces.

Figures 19–21. Monostability is obtained due to dominance of the outer hollow attachment wall over the small, vestigial inner wall—surface of the small central cone. Later, also the axisymmetric valves were required to be controllable by an external signal (Tesař, 1999, 2000; Tesař *et al.*, 1996, 2000). One possibility of deriving the suitable pressure (rather than vacuum) control may be e.g., the use of the pressure drop on the supercharger turbine, Figure 25. In fact simply the pressure drop across

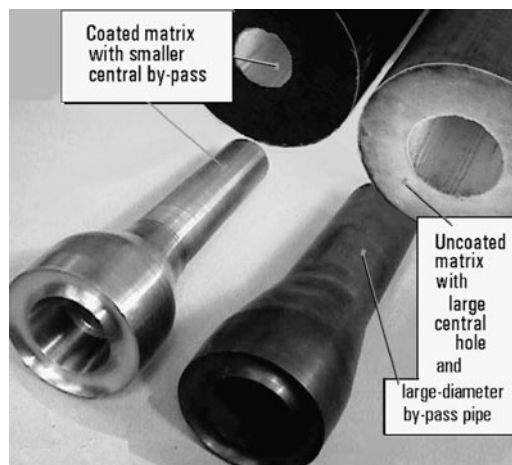

Figure 27. Photograph of the present author's two laboratory models of the splitter and by-pass pipe with reactor matrices adapted by drilling the large central by-pass hole.

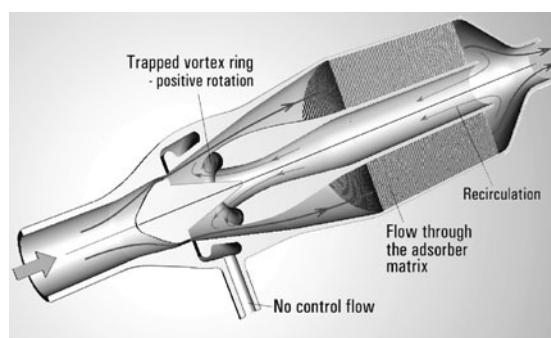

Figure 26. The axisymmetric version of the by-passing (Figure 22) with external control, developed by the author for regeneration of NO_x trap. This illustration shows the flow (partly re-circulating) through the matrix in absence of a control flow.

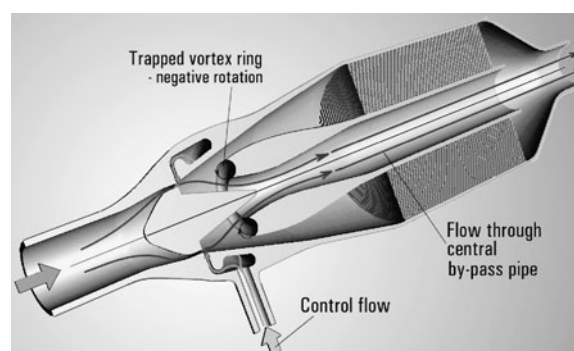

Figure 28. The regeneration regime: admitted control flow into the integral diverter valve switches most of the flow into the central by-pass tube, enabling creation of reducing atmosphere in the reactor matrix.

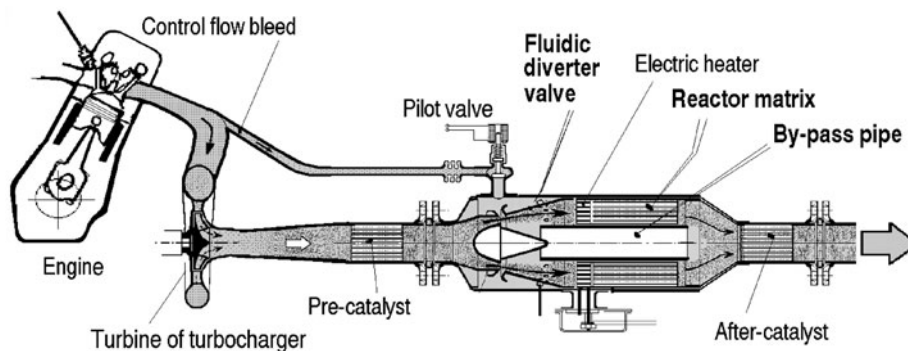

Figure 29. One of the several possible sources of the control flow is the pressure drop across supercharger turbine.

the main nozzle of the valve was found sufficient for use as the control nozzle flow.

A simple geometry without sophisticated contouring of the splitter is described by Tesař (2004), where there is a more detailed information about design details and use of CFD as essential design tool. Later versions used the trapped vortex ring stabilisation and improved diffusers. Thanks to an interest from Volkswagen A.G., Wolfsburg, Germany, an aerodynamic model, intended for use with an intermittently regenerated catalytic NO_x storage reactor (Figures 25–28) was tested by the author and collaborators in a vehicle on a test stand (Tesař *et al.*, 1996, 2000). It demonstrated successfully that the flow pulsation in the exhaust system does not disrupt the Coanda attachment.

CONCLUSION

No-moving-part fluidics, with its advantages of robustness and reliability is little known and used. Chemical engineering is one of the few areas where the merits have been recognized—but even there the uses are not as common as they deserve. The new applications in the advanced aftertreatment systems, based on the idea of variable configuration, can eliminate the drawbacks brought by classical mechanical valves. The fluidic valves are inexpensive, resistant to the effect of adverse environment. The critical factor is the value of the pressure recovery factor π_Y (Figure 16). Recent axisymmetric versions are quite good in this respect and offer exceptional compactness. This qualitative step forward is worth being considered also in other areas of chemical engineering, especially in facilities operating in regeneration modes.

NOMENCLATURE

| | |
|-------------------------|---|
| A_{reactor} | Sum of cross-section areas of flow paths in the reactor, m ² |
| A_{valve} | characteristic cross-section area in the valve, m ² |
| B | constant of the valve and fluid, defined by equation (6), s m |
| \dot{M} | mass flow rate (general), kg s ⁻¹ |
| \dot{M}_Y | valve output mass flow rate, kg s ⁻¹ |
| $\dot{M}_{Y\text{max}}$ | maximum valve output mass flow rate defined by equation (4), kg s ⁻¹ |
| \dot{M}_s | supply mass flow rate, kg s ⁻¹ |
| P | pressure, Pa |
| P_Y | pressure in the Y-tap location, Pa |
| P_V | vent pressure, Pa |
| P_S | pressure in the S-tap location, Pa |
| Q | quadratic dissipation (general), m ² kg ⁻² |
| Q_L | quadratic dissipation of the load (=reactor), m ² kg ⁻² |
| Q_S | valve output quadratic dissipation, m ² kg ⁻² |
| q | relative loading dissipation |
| Re | main nozzle exit Reynolds number |
| T | temperature, K |
| Te_L | dimensionless loading parameter |
| $Te_{L\text{max}}$ | maximum attainable value of loading pressure parameter |
| Te_S | dimensionless main nozzle pressure drop |
| Te_Y | dimensionless collector pressure rise |

Greek symbols

| | |
|--------------|--|
| ΔP | pressure drop, Pa |
| ΔP_a | constant pressure output of ideal pressure generator, Pa |
| ΔP_S | pressure drop across the main nozzle, Pa |
| ΔP_Y | pressure rise in the collector, Pa |
| ΔT | temperature difference, K |
| μ | relative flow, defined by eq. (7) |
| μ_Y | relative output mass flow rate |
| μ_X | relative control mass flow rate |
| π_Y | pressure recovery factor |

REFERENCES

- Eastwood, P., 2000, *Critical Topics in Exhaust Gas Aftertreatment* (Research Studies Press Ltd., Baldrock, UK).
- Engler, B.H., Leyrer, J., Lox, E.S. and Ostgathe, K., 1993, Catalytic reduction of NO_x with hydrocarbons under lean diesel exhaust conditions, SAE Technical paper No. 930735.
- EPA, 2000, Regulatory impact analysis: control of emissions of air pollution from highway heavy-duty engines, United States Environmental Protection Agency Report EPA420-R-00-010.
- König, A., Herding, G., Hupfeld, B., Richter, Th. and Weidmann, K., 2001, Current tasks and challenges for exhaust aftertreatment research. A viewpoint from the automotive industry, *Top Catal*, 16/17(1–4): 23–31.
- König, W., Held, W. and Richter, T., 2004, Lean-burn catalysts from the perspective of a car manufacturer. Early work at Volkswagen research, *Top Catal*, 28(1–4): 99–103.
- Mitsubishi Motors, 1997, 4G93 GDI engine technical information: reduced exhaust emissions. Available on request from Public Relations and Investor Relations Department Mitsubishi Motors Corporation, 16–4, Konan 2-Chrome, Minato-ku, Tokyo 108–8410, Japan.
- Perera, P.C. and Syred, N., 1983, A Coanda switch for high temperature gas control, Paper 83-WA/DSC-26, American Society of Mechanical Engineers, ASME Winter Annual Meeting, Boston, USA.
- Priestman, G.H. and Tippetts, J.R., 1984, Development and potential of power fluidics for process flow control, *Trans IChemE, Chem Eng Res Des*, 62(2): 67.
- Tesař, V., 1976, Some basic solutions of fluidic circuits involving the quadratic dissipation, *Struynaya tehnika, Proceedings of VI International Conf. on Fluidics*, Moscow, Soviet Union.
- Tesař, V., 1994, Fluidic load-switched valve for hot gas flow control, *Proc. of FLUCOME '94—the 4th Triennial Internat. Symp. on Fluid Control, Fluid Measurement, and Visualization*, Toulouse, France, 741.
- Tesař, V., 1996, Fluidické ventily s mezikruhovým proudem překlápěným mezi kuželovými stěnami (Fluidic valves with an annular jet switched between conical walls—in Czech), in *SEMINAR '96*, KHSZ, VUT Technical University Brno, Czech Republic, 11–16.
- Tesař, V., 1997a, Axisymmetric monostable fluidic valves, *Proceedings of WORKSHOP 97*, ČVUT Prague, Czech Republic, January 1997, 453.
- Tesař, V., 1997b, Axisymmetric fluidic valves for use in automobile exhaust gas aftertreatment, *Proc. of FLUCOME '97, Vol. 2*, Hayama, Japan, 529–534.
- Tesař, V., 1998a, Valvole fluidiche senza parti mobili (Fluidic valves without moving components—in Italian), *Oleodinamica—pneumatica*, ISSN 1 122-5017, No. 3, Anno 39, Torino, Italy, 216–223.
- Tesař, V., 1998b, Law for pressure loss in monolithic reactor matrices, *Proc. of Colloquium "Fluid Dynamics '98"*, ISBN 80-85918-45-5, publ. by Inst. of Thermomechanics, Acad. Sci. Czech Rep., Prague., 59.
- Tesař, V., 1999, Control of recycling chemical reactors by fluidic valves, *Proc. of IX Internat. Conf. ICMR '2000*, ISBN 83-88066-01-3, Publ. by ATR-SAWO, Bydgoszcz, Poland, May 1999, 95–102.
- Tesař, V., 2000, Monolithic reactors with integral fluidic valve by-pass flow control, *Proc. Xth Internat. Conf. ICMR '2000*, ISBN 83-88066-06-4, Bydgoszcz, Poland, 23–32.
- Tesař, V., 2004, Fluidic valve for reactor regeneration flow switching, *Trans IChemE, Part A, Chem Eng Res Des*, 82, 398.
- Tesař, V., Tippetts, J.R., Low, Y.Y. and Allen, R.W.K., 2004, Development of a microfluidic unit for sequencing fluid samples for composition analysis, *Trans IChemE, Part A, Chem Eng Res Des*, UK, Part A, 82(A6): 708–718.
- Tesař, V., Baumruk, P., Macek, J., König, A., Decker, G. and Donnerstag, A., 1996, Fluidic valves for variable-configuration exhaust gas aftertreatment system, XXVI Congress FISITA—Fédération Internationale des Sociétés d'Ingénieurs des Techniques de l'Automobile, Sect. A, Part 2, Prague, Czech Republic.
- Tesař, V., König, A., Macek, J. and Baumruk, P., 2000, New ways of fluid flow control in automobiles: experience with exhaust gas aftertreatment control, *Proc. of World Automobile Congress*, Paper No. F2000H192, Society of Automotive Engineers, ISBN 89-85000-00-4 98550, Seoul, S. Korea, 167.
- Tesař, V. and Reisenberger, E., 1999, Aerodynamic investigations of trapped vortex rings, *Proc. of 8th WORKSHOP 99*, CTU Reports, Special Issue, Vol. 3, Prague, Czech Republic, April 1999, 244.

The manuscript was received 11 October 2004 and accepted for publication after revision 3 August 2005.