

This is a repository copy of *New Horizons*.

White Rose Research Online URL for this paper:

<https://eprints.whiterose.ac.uk/128205/>

Book Section:

Boxall, Alistair Bruce Alleyne orcid.org/0000-0003-3823-7516 and Dalton, Andrew R H (2018) *New Horizons*. In: *Annual Report of the Chief Medical Officer 2017, Health Impacts of All Pollution - what do we know?* , pp. 107-138.

Reuse

Items deposited in White Rose Research Online are protected by copyright, with all rights reserved unless indicated otherwise. They may be downloaded and/or printed for private study, or other acts as permitted by national copyright laws. The publisher or other rights holders may allow further reproduction and re-use of the full text version. This is indicated by the licence information on the White Rose Research Online record for the item.

Takedown

If you consider content in White Rose Research Online to be in breach of UK law, please notify us by emailing eprints@whiterose.ac.uk including the URL of the record and the reason for the withdrawal request.

Annual Report of the Chief Medical Officer 2017, Health Impacts of All Pollution - what do we know?

Foreword



Dear Reader

Pollution, most particularly air pollution, is receiving a great deal of attention in the United Kingdom at the moment. However, tackling pollution (in all its forms) has not been foremost in the minds of health policy makers in recent years. It has been the role of public health professionals of all disciplines, and the wider public health workforce, to guard the public from the health impacts of pollution.

I chose to address pollution in this, my ninth, annual report because I believe it is time for policy makers to take seriously the threat to health posed by pollution, and therefore to understand that addressing pollution is disease prevention. Everyone understands that acute exposure to a toxic substance will cause ill-health. Lesser known, and understood, is the relationship between longer-term, lower level exposure to pollutants. We already know there is a link in some instances: think of the opportunities to improve health that may be at our fingertips if we can better integrate socio-demographic, health and environmental data – using this to better understand these threats.

And who will benefit from this? Clearly we will all benefit but those dedicated to reducing health and environmental inequalities may take particular interest in Chapter 6 of this report, 'Pollution and inequality'.

I would like to see all forms of pollution at the forefront of professional and public attention. I hope this report helps to inform the conversation.

Yours ever

Sally C

A handwritten flourish or signature mark in purple ink, consisting of a long, sweeping curve that ends in a small hook.

This report could not have been produced without the generous input of the editors, Chapter Leads, Chapter Authors and contributors. The Chief Medical Officer, Professor Dame Sally Davies expresses her thanks to all those who contributed to this report.

Editor-in-Chief

Andrew Dalton, Public Health Specialty Registrar, West Midlands Deanery

Project Manager and Editor

Orla Murphy, Department of Health and Social Care

An accessible PDF download of this report will be made available via www.gov.uk on the day of report publication.

Contents

Chapter 1 Chief Medical Officer's summary

Prof Dame Sally C. Davies, Chief Medical Officer, Department of Health and Social Care

Chapter 2 Pollution from the health and care System

Prof David Pencheon, Honorary Professor, Health and Sustainable Development, Medical School, University of Exeter Medical School
Dr Andrew R. H. Dalton, Public Health Specialty Registrar, West Midlands Deanery

Chapter 3 21st century chemicals

Prof Timothy W. Gant, Helen E. Smith, Dr Emma L. Marczylo, Dr Miriam N. Jacobs, Dr Timothy H. Marczylo, Dr Ovnair Sepai, Mr Andrew Tristem of Centre for Radiation, Chemical and Environmental Hazards, Public Health England

Chapter 4 New horizons

Prof Alistair Boxall, Professor in Environmental Science, University of York
Dr Andrew R. H. Dalton, Public Health Specialty Registrar, West Midlands Deanery

Chapter 5 Economics of pollution interventions

Dr Laure de Preux, Assistant Professor in Economics, Imperial College Business School
Prof Franco Sassi, Professor of International Health Policy and Economics, Imperial College Business School

Chapter 6 Pollution and inequality

Prof Gordon Walker, Lancaster Environment Centre, Lancaster University
Dr Gordon Mitchell, School of Geography, University of Leeds
Prof Jamie Pearce, School of GeoSciences, University of Edinburgh

Chapter 7 Environmental health - response to pollution

Dr Naima Bradley, Head of Environmental Hazards and Emergencies Department, Public Health England

Dr Patrick Saunders, Visiting Professor of Public Health, University of Staffordshire

Dr Benjamin Fenech, Principal Noise and Health Scientist, Public Health England

Ms Vicki Rhodes, Senior Specialist (Special Topics), Environment Agency

Chapter 8 Pollution - data, surveillance and health impacts

Prof Paul Elliott, Dr Frédéric B. Piel, Dr Daniela Fecht and Dr Anna L. Hansell of UK Small Area Health Statistics Unit (SAHSU), MRC-PHE Centre for Environment and Health, Department of Epidemiology and Biostatistics, School of Public Health, Imperial College London

Chapter 9 Measurement and communication of health risks from pollution

Prof Kevin McConway, Emeritus Professor of Applied Statistics, Open University

Prof Helene Joffe, Professor of Psychology, University College London

Prof Marian Scott, Professor of Environmental Statistics, University of Glasgow

Sir David Spiegelhalter, Winton Professor of the Public Understanding of Risk, University of Cambridge

Dr Heather Walton: Senior Lecturer in Environmental Health, King's College London

Chapter 1

Chief Medical Officer's summary

Chapter author

Sally C. Davies¹

1 Chief Medical Officer, Department of Health and Social Care

Introduction

As Chief Medical Officer for England I have a statutory duty to produce an annual report on the state of the public's health. These reports – like me – are independent of Government, and call on stakeholders across the policy spectrum to make changes that will improve our health. They draw on the expertise of the Chapter Leads – preeminent academics and practitioners in their fields – who come together to give their views and inform my independent recommendations. I am grateful to them all for their help.

This year I have chosen to focus my report on the impact of pollution on human health.

Pollution affects everyone, every day. Our children are affected by noise pollution from roads near their schools; our houses are washed with light pollution every night; we are exposed to chemicals in the almost invisible dust in our houses. There are no aspects of our life that do not have the potential to be impacted by pollution. Most pollutants are by-products of actions and processes of society. The social and/or economic benefit of these processes may at times outweigh the generally low risk they pose to human health. There are some pollutants, however, which have either been shown to have a significant negative impact on human health or have limited evidence associated with them that implies this is possible.

Use of ‘Risk’ and ‘Hazard’ in this report

‘Hazard’ refers to the inherent properties of a substance that make it capable of causing harm to a person or the environment.

‘Risk’ is the possibility of a *harm arising* from a particular exposure to a substance, under specific conditions.ⁱ

On researching this report I expected to find many concrete actions official bodies could take to reduce the impact of pollution on the public’s health. I have been surprised by how little we know about many of the common pollutants that surround us each day. There are some areas where we do know enough to act, and here we should do so with urgency. The chapters that follow contain numerous suggestions from experts for policy makers and officials. I make my recommendations in this chapter.

Overall, I have been struck by the lack of evidence we have in this field. This is not for want of trying on behalf of academics and practitioners. At the moment we do not have the systems in place to effectively monitor, understand, and act on data about the health impacts of pollution. The clarion call from this report is therefore to create these systems so that we can determine effective actions. As I will set out, this will require a conceptual shift: we must start to address pollution as disease prevention. And we must consider the impact on human health of all of the different singular pollutants alone AND *in combination with others*, over short AND over long-term periods.

First – some context. I became Chief Medical Officer in 2011, and pollution has featured in most of my reports. For example, in my first surveillance report, published in 2012, I highlighted the World Health Organization’s inclusion of urban air pollution among the top ten risk factors for mortality in the UK. This should come as no surprise to the public health profession as we have our roots in environmental health. The early public health professionals in the nineteenth century set out to uncover the environmental causes of diseases and find solutions to improve our ancestors’ health.

This era saw great change to the way our society and built-environment was structured, in order to improve health. The sweeping sanitary reforms and public works of the mid-nineteenth century are the basis of modern sanitation and drinking water systems, for example. This progress continued into the mid-twentieth century, with significant pieces of legislation such as the 1956 Clean Air Act which finally

ⁱ Definition adapted from <https://www.chemicalsafetyfacts.org/>

banished the infamous smog of UK cities. These achievements remain some of the biggest successes that we have had in improving the public's health.

That is the past. Now the question for all of us working to improve the public's health –must be: is our modern approach to pollution working?

Purpose and remit of this report

Purpose

I intend my report to bring political, policy and health system attention to pollution as a threat to the public's health, both at acute exposure but also at lower-level, longer-term exposure. I want to emphasise the role pollution plays in non-communicable diseases (NCDs) and recommend means to better understand and tackle this threat; we can structure our research and public sector organisations to look at the whole spectrum of pollution holistically.

Remit

My reports cannot cover every aspect of a topic, to do so they would be unmanageably large. I have therefore placed a number of parameters around the report remit in order to make the scope of this report manageable and to ensure the recommendations I make are achievable.

This report focuses on the direct impact of pollution on human health. This reflects my role as Chief Medical Officer. I do take a 'one health approach', which recognises that human illness, and the flora and fauna that surround us, can be closely linked. Whilst this report covers some pollutants of concern to environmental policy colleagues, other pollutants that concern them are not addressed.

Pollution is at once intensely personal, rooted in the experience we all have of our own lived environments, but also global in scale, with pollutants moving across international borders. This is why pollution is becoming established as a priority for the international community. The United Nations' Sustainable Development Goals – the SDGs, (also known as the Global Goals), contain specific targets for member states to substantially reduce the number of deaths and illnesses from hazardous chemicals as well as air, water, and soil pollution and contamination by 2030. My report is cognisant of this interconnected world, but focused on the people and pollutants in England.

Climate change is a very serious issue and whilst I recognise there are links between climate change and pollution, this report does not examine these issues. I stress, however, that I am of the view that greenhouse gasses are pollutants and likely pose long-term health threats.

Changing how we think about pollution

Pollution

Any undesirable modifications of our human environment including air, water, soil, and food by substances that are toxic or may have adverse effects on health - or that are offensive even if not necessarily harmful to health.ⁱⁱ

Since the mid-twentieth century, pollution has slipped down the agenda as a public health issue. This was driven, in part, by the eradication of many of the contaminants with the most visible health impacts, with the remaining ones harder to elucidate. We also now face competing threats to our health, such as the obesity epidemic and declining physical activity levels. These threats are real and must be addressed. However, this has all resulted in a position where the impacts on human health of most pollutants are not fully understood, particularly where they act in concert. Instead of being seen as a *health* issue, pollution is often seen primarily as an *environmental* problem. This needs to change. As a society we need to regain a focus on pollution as a threat to human health.

By-and-large, pollution is currently thought of as an acute health threat: something which elicits a negative health response following a 'dose' of exposure. We think of pollutants as rapid poisons, rather than long-term risk factors for a variety of diseases. However this is not the case; evidence shows that many pollutants are risk factors for a range of NCDs such as cardiovascular disease, cancer, asthma, and chronic obstructive pulmonary disease.ⁱⁱⁱ We need to investigate the longer-term impacts of lower-level pollution exposure; this exposure is likely to have a significantly deleterious impact at a population level due to the extent of the exposure. Pollution should be recognised for what it is: a significant cause of NCDs. Addressing pollution is therefore disease prevention.

Recommendation 1

I recommend that Public Health England convenes a Programme Board to co-ordinate government action to reduce the contribution of pollution to non-communicable diseases. This Board should include representation from Environment Agency and should be supported by the Government Expert Scientific Advisory Committees.

ⁱⁱ Adapted from 'A Dictionary of Epidemiology', edited by Miquel Porta, Oxford University Press, 2014.

ⁱⁱⁱ I also note the growing evidence that pollution, notably air pollution, increases risk of infectious disease – although currently the magnitude of this impact is smaller than that of NCDs

We must consider the health impacts of all pollutants, addressing them proportionately to our best understanding of the risk. A step beyond focusing on the full suite of pollutants that we are exposed to, is considering how we are exposed to them. Pollution mixtures are the norm – be it chemical mixtures or cross-media mixtures.

The UK Government's publication, 'A Green Future: Our 25 Year Plan to Improve the Environment' sets a vision - from 'the environment's perspective'.

Recommendation 2

I recommend that the UK Government fulfils its promise to publish a chemicals strategy, and that this strategy takes full account of the human health impacts of chemicals, including chemical mixtures.

As well as contributing to and causing NCDs, pollution contributes to inequalities. Health inequality remains one of the great social injustices in England today. There is both growing evidence and consensus that deprived groups in England are exposed more to pollution (notably air pollution), whilst certain groups – those with existing underlying medical conditions, the young and old, and others – likely face a greater health impact from pollution exposure. We must account for pollution within the health inequalities agenda and address and plan to prevent/ reduce pollution in the context of equality and fairness.

Vulnerable groups, such as young children, the elderly, those with underlying medical conditions and others, are at a disproportionately high risk from poor air quality. These groups can suffer large health burdens, and children, for example, can have lifelong poor health outcomes attributable in part to pollution exposure. I commend work to protect these groups, such as the work underway in London to improve air quality around schools currently exposed to the highest levels of air pollution in the city.

Recommendation 3

I recommend the Greater London Authority commission, and Public Health England support, the evaluation of the health and health economic impact of action taken in response to Mayor of London commissioned audits designed to improve air quality near schools in London.

Acting where we can

There are pollutants where the evidence of their health impact is reasonably strong, often (but not always) where it has been easiest to measure. Where the evidence is strong that there are negative health consequences and evidence of effective interventions to address it, this action should be continued and accelerated. In other areas, where there is evidence of health impacts but not of the effectiveness of interventions to reduce this, then we must act to develop the latter.

Recommendation 4

Local government holds authority over local planning and infrastructure, and has expertise such as environmental health and public health colleagues. It can take powerful action to address and avoid negative health impacts from pollution. Local government and public health professionals in particular must seize this opportunity to improve the health of their local population by implementing concrete, evidence based actions to address pollution.

Recommendation 5

I recommend that in order to prevent ill health, local authorities need to broaden current environment strategies (e.g. those which may or may not cover NO_x or noise); these strategies should be cognisant of all forms of pollution, and consider risk at both consistent low-level exposure and intermittent high level exposure.

Recommendation 6

I recommend that Public Health England supports local authorities' response to the health impacts of all pollutants by making available:

- a) up to date evidence on the health impacts of pollution and
- b) toolkits to assist with Local Authority actions to avoid or ameliorate pollution.

Recommendation 7

I recommend that the potential impact of all relevant forms of pollution upon human health should be considered at all stages of local authority planning, considering risk at both consistent low-level exposure as well as intermittent high level exposure.

Outdoor air pollution has recently attracted a great deal of attention from media, scientists and policy professionals. Although there are great uncertainties over the exact extent, the evidence indicates a significant negative impact on human health (see Annex 1). This is, therefore, an example of where we must act, and where we know much of what will work. We need to roll out and embed into routine use actions that we know will improve health; evaluate and explore new ways to act (Box 1) – not missing out on the opportunities for natural experiments as action is taken; and fill evidence gaps.

I welcome the government's national standards for air pollution. Currently these standards are being breached. The Government's NO_x plan is a good overall document but as it is aimed at local authority level, it may

- a) be implemented inconsistently,
- b) contribute to inequality, and
- c) contribute to complexity of local regulation for drivers.

Recommendation 8

I recommend that future UK government national standards for air pollutants, developed within the next five years, should be increasingly stringent and driven by an ambition to protect human health.

Recommendation 9

I recommend that Department for Transport should agree with local authorities standardised mechanisms and protocols for surveillance and road charging (if introduced), such that

- a) health data and local authority data may be better integrated; and
- b) vehicle drivers experience a simple system with consistency across England.

We must further expand this focus to indoor air. Work to gather evidence of health impacts, raise awareness of any harm and highlight actions to address this is needed, just as the Royal College of Paediatrics and Child Health /Royal College of Physician Working Group on indoor air quality and child health proposed.

Recommendation 10

I recommend that Department for Environment, Food and Rural Affairs investigate the availability and quality of (low cost) indoor air pollution monitors, publishing their results, in order to support the public's use of home air quality monitoring equipment.

Box 1 Solar-Assisted Large-Scale Cleaning System (SALSCS) for Urban PM2.5 Mitigation

Professor David Y. H. Pui, University of Minnesota

A Solar-Assisted Large-Scale Cleaning System (SALSCS) is an emerging method used for air quality abatement – or to clean polluted air. In these towers, solar heating warms the polluted ambient air, drawn in at the base, which rises. A filter bank, placed around the tower entrance, removes PM2.5 pollutants so that clean air exits from the top of the tower (figure 1). By placing the SALSCS near a large city, it pulls polluted air in and returns clean air to the city, reducing the PM2.5 concentration.

Figure A Schematic diagram of the Solar-Assisted Large-Scale Cleaning System

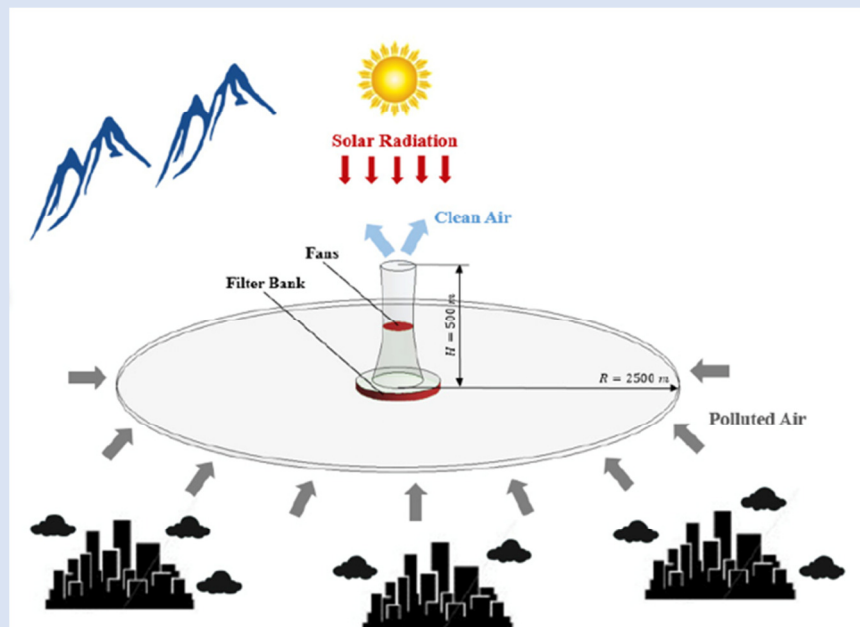

The first pilot scale SALSCS in Xi'an, funded by the Shaanxi government, aimed to demonstrate the concept (figure 2). As well as PM2.5 filters, catalyst-coated glass panels were added to reduce gaseous pollutants (for example, NO_x). Short-term measurements showed PM2.5 concentrations in the district where the SALSCS was located approximately 12% below the surrounding districts. This matched the projected impact of the SALSCS – based on the airflow through the system. Long-term measurements are now being conducted. This pilot tower is smaller than those proposed in modelling studies – for example its height of 60 m, compared with proposed 500m towers. Models suggest 8 full scale SALSCS units could reduce PM2.5 in the Beijing urban area by 15% in 30 hours.

Figure B A night-view of the 1st generation SALSCS built in Xi'an, Shaanxi Province (completed July 2016)



Further improvements to the SALSCS are being developed. A second generation SALSCS at Yancheng Science Park, Jiangsu Province uses water-spray droplets to coalesce and remove PM_{2.5} particles (figure 3). This gives dual capability, removing PM_{2.5} as well as atmospheric CO₂ using NaOH solution. Its performance is now under evaluation. A 3rd generation SALSCS (called ACAN) has been designed and is under development. The air flow through the ACAN is reversed (figure 4). A set of fans draws dirty air from the tower inlet and pushes it through the filters (or water-spray) located in the base. The clean air will bath the living quarters of the residents nearby, benefiting the immediate vicinity. The ACAN is intended for more targeted use: by placing it in the centre of a set of tall apartment buildings, it will promote air recirculation. Computational fluid dynamics calculations show that more than 50% of the PM_{2.5} concentration can be removed within a few hours of operation.

Figure C The 2nd generation SALSCS built in Yancheng Science Park, Jiangsu Province (completed September 2017)



Figure D Schematic diagram of the 3rd generation cleaning system ACAN showing the reverse flow configuration

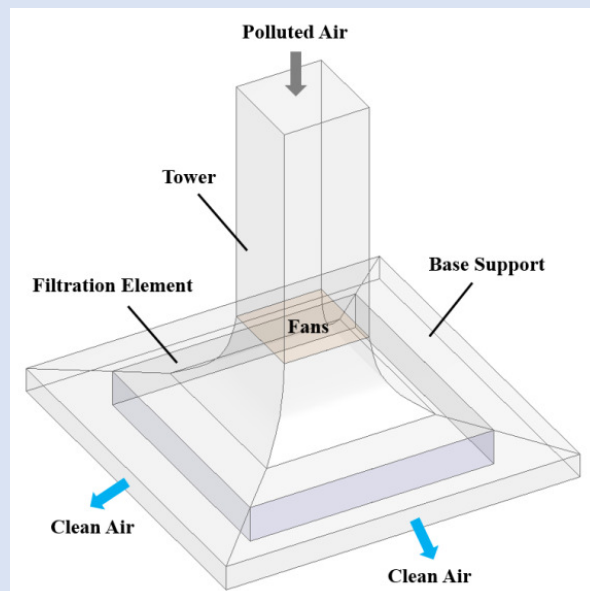

The SALSCS technology represents an effective and low-cost way to mitigate both PM2.5 and CO2, for the health and well-being of mankind.

There is sufficient evidence to say that a number of industries and sectors could be asked to take responsibility for the pollution they produce and its consequences for human health. In my report I have focused on the sector which I know best – the health service – and make recommendations relevant to both local hospitals and wider policy makers.

Recommendation 11

I recommend that industry leaders should work to:

- a) be more transparent about the polluting effect of their activities,
- b) strive to reduce this effect, using innovative interventions, and
- c) bring success and best practice to attention within their industry.

My reasons for focusing here are twofold. Firstly, if we are to get industries to act on the health impacts of the pollution they produce, much of which will be as a result of products and processes which we value, then it seems reasonable that health professionals and policy makers should lead the way and demonstrate all the great progress some have made. Secondly, it is the case that the health service in this country is a significant polluter simply due to its size. There is positive action being taken, some led by NHS Sustainable Development Unit and some led locally by trail-blazing trusts. Some of this is presented as case studies here (box 2), particularly in Chapter 2 of this report 'Pollution from the Health and Care System'. The health service causes a lot of pollution – it makes sense to strive to reduce this.

To address the health impacts of pollutants the public sector, including the health and social care system, should implement actions that we already know work (see examples in this report). In leading the way, our NHS needs to demonstrate action and progress through transparency.

Recommendation 12

I recommend that

- a) NHS Trusts report progress against their Sustainable Development Management Plans in their annual reports, supported by publication of all relevant underlying data;
- b) Public Health England should aggregate and analyse progress annually for a national public report to NHS Improvement; and
- c) NHS Improvement should review Trusts' performance and recommend remedial action to Trusts, as appropriate.

Recommendation 13

I recommend that

- a) Clinical Commissioning Groups should analyse local air quality monitoring data for breaches of air pollution standards, and publish these alongside the local hospital data for impacts on admissions for respiratory and cardiovascular disease and
- b) Public Health England should aggregate and analyse progress annually for a national public report to NHS England.

I commend the efforts of Ambulance Trusts to phase out diesel vehicles and reduce idling. South Central Ambulance Service NHS Foundation Trust is experimenting with photovoltaic cells to keep electrical equipment in ambulances powered, whilst avoiding idling. Innovation and exploration like this should be championed locally and nationally.

Recommendation 14

I recommend that

- a) Ambulance Trusts should publish annually on their progress towards phasing out diesel ambulances, including explaining how their routine procurement decisions pay heed to National Institute for Health and Care Excellence guidance on low vehicle emissions^{iv} (nitrogen oxides and particles) and
- b) Public Health England should aggregate and analyse progress annually for a national public report to NHS England.

^{iv} <http://indepth.nice.org.uk/no-idle-zones-can-help-protect-vulnerable-people-from-air-pollution-says-nice/index.html>

Recommendation 15

I recommend Health Education England convene and lead a working group, to include the Royal Colleges and Faculties of Health, to ensure that the health impacts of pollution are included in curricula for all clinicians in training. The group should also ensure the health impacts of pollution are included in continuous professional development programmes for existing staff.

Box 2 Nottinghamshire Healthcare NHS Foundation Trust

Lynn Richards, Energy and Environmental Manager and Sustainability Advisor, NHFT

Nottinghamshire Healthcare NHS Foundation Trust is committed to reducing the environmental impact associated with its service delivery and seeks to provide healthcare which is truly sustainable. Each year performance in key areas such as waste, energy, procurement and travel is monitored and progress is reported in the Trust's Annual Report.

Our environmental objectives and targets are contained within the Trust's Sustainable Development Management Plan (SDMP). In response to organisational change, making significant progress against the existing plan, and updated guidance from the NHS Sustainable Development Unit, incorporating the United Nations Sustainable Development Goals, the SDMP is currently being reviewed to make sure it accurately reflects the ambitions of the Trust.

Within the Estates and Facilities Directorate, the Trust holds accreditation to ISO14001:2004 the internationally recognised environmental standard. This ensures that we set environmental objectives, meet compliance obligations, and make a commitment to the protection of the environment, and to the prevention of pollution.

The Trust has a network of staff Green Champions, and with their support we actively undertake projects and engage with local and national campaigns, such as National Clean Air Day and Fairtrade Fortnight. These help to promote behaviour change both within and outside of the work environment, maximising the positive effects.

The Trust has won awards for its environmental projects, for example for the Ray Crampton Energy Centre at Rampton Hospital. Not only has this helped to reduce the Trust's carbon footprint and costs but it has also improved resilience and local air quality, as the site no longer needs to burn coal.

Box 3 **City of York Council – a holistic approach to reducing pollution**

Mike Southcombe, Public Protection Manager, City of York Council

City of York Council takes a holistic approach to reducing pollution from all sources; examples of this are its' One Planet York initiative and being the first council to adopt a holistic Low Emission Strategy (LES) with policies to reduce both carbon and other pollution.

Planning applications are reviewed for contaminated land, air quality, noise and other pollution to mitigate the impact of new developments on people's health and environment. Our contaminated land and low emission planning policies have been adopted by others to help developers to reduce pollution. York regulates pollution from industry and has written guidance to control noise from licensed premises and events, with an out of hours service to deal with complaints.

York is at the forefront of developing policies to achieve the health-based air quality objectives, hence being awarded Ultra Low Emission City status. An extensive Pay As You Go electric vehicle charging network, funded by grants and a green charity, meant York was an early adopter of electric vehicles. A taxi incentive scheme coupled with an emission based taxi licensing policy has resulted in 15% of York's taxis being low emission (petrol hybrids). York's citywide monitoring network (and several feasibility studies) enables an evidence based approach to air quality strategy and planning and led to the use of electric buses and the concept of a bus based Clean Air Zone (CAZ) in the city centre; the CAZ is currently out for consultation. Anti-idling policies were approved recently and follow on from public awareness-raising of the health impacts of air pollution, working with local universities, business and the public, including participation in National Clean Air Day.

Gathering data where we cannot act with certainty

Unfortunately we do not currently understand enough about many pollutants to be certain whether they impact negatively on human health, especially at low to moderate levels with long-term exposure. We understand less still about what action we could take to ameliorate any harmful effects on health.

Some of these pollutants have been in our environment for centuries but have never had data collected about their health impacts. Additionally, new techniques can reveal previously unknown negative health impacts. I argue that we have not thought enough about the impact of multiple pollutants at low exposure across a long period or in relation to long-term health impacts (namely NCDs). Some pollutants are only just emerging; for example newly synthesised chemicals, new technologies such as nanoparticles and the potential harms from *chemicals in products*.^v Chapter 4 of this report, 'New horizons', addresses some of the newer substances we need to consider as potential pollutants.

Recommendation 16

I recommend Public Health England investigate the creation and funding of a mechanism to synthesise evidence concerning the health impacts of all pollutants, and publish evidence-based statements on the health impacts of these pollutants in England.

Throughout this report, data, information and evidence are apparent as vital resources to address the health impacts of pollution, and priority areas for improvement. Data has emerged as a central theme in my previous annual reports – obviously in genomics but also in the metrics that we use to monitor issues such as mental health. The data and information revolution is happening across biomedicine and has the potential to improve the health of the public. Pollution and human health is no different: we have a real opportunity to capitalise on the use of data to better understand these health impacts.

Facilitated by new, especially mobile, technologies, there has been a recent growth in citizen science. This has a role in data collection and knowledge generation around the impacts of pollution on human health. Quality and standards of data collection must, however, be maintained to give reliable and useful data.

^v Defined as chemicals contained in everyday consumer products

Recommendation 17

I recommend that UK Research and Innovation consider a health-related pollution topic for one of its first, national Citizen Science endeavours.

There are two distinct, albeit inter-related, types of data of the health impacts of pollution (Figure 1.1) that can be improved through integration of different pieces of data;

- a) Static research data – helps us to gain knowledge about health harms from pollution and;
- b) Surveillance data – allows the monitoring of known threats and for signals of new threats.

Achieving this data integration will not be easy, but they would greatly help our understanding of, and ability to tackle, the health impacts of pollution.

Figure 1.1 The relationship between research and surveillance dataset covering the health impact of pollution

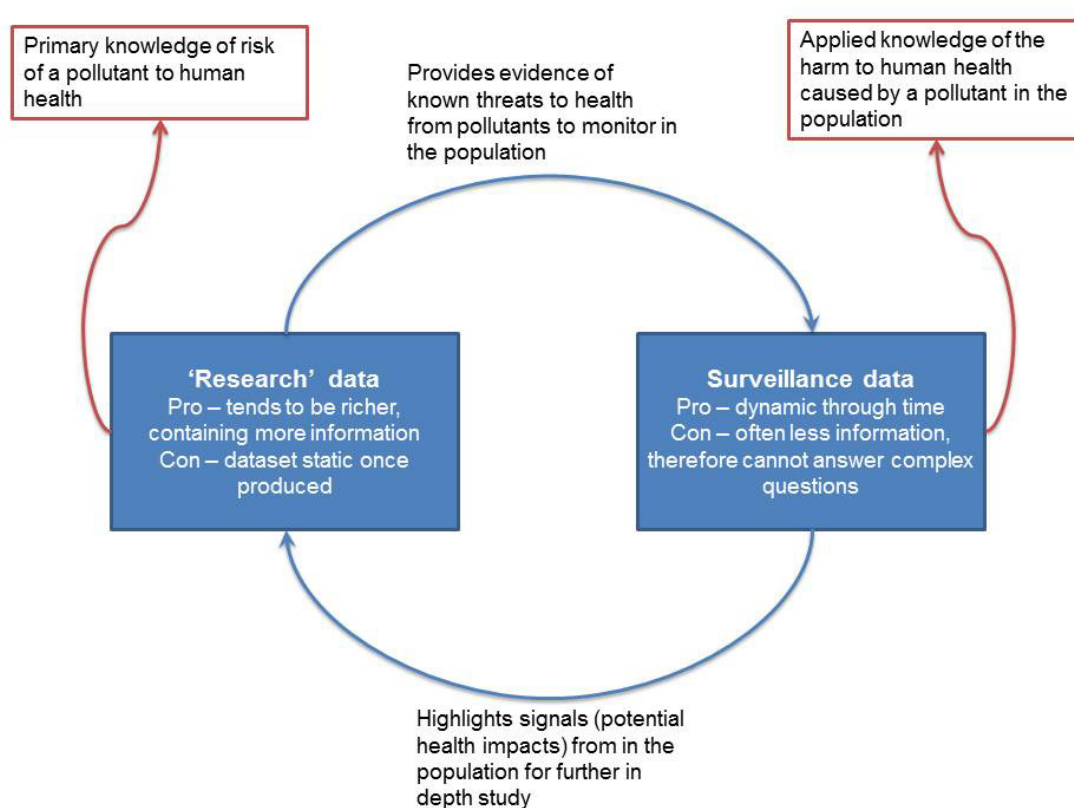

Source *Andrew R H Dalton*

It is easy, of course, to agree that we should have high-quality data used in a joined-up way – but what does this actually mean? Firstly, we need to integrate existing data and ensure wherever possible this is available open source. We need to use health data with a wider range of health outcome. In other words, not just focusing on mortality, but using data that capture the full health consequence of pollution on morbidity, mental health impacts, and impacts on quality of life. We need to collect new types of data, such as biomarkers and those relating to genetic susceptibilities. We need to develop bespoke statistical and research methods to mine these data. And we need to have access to surveillance data in real time, allowing us to act to improve health, identify vulnerable groups, and give insight into emerging issues.

It is clear: the evidence base around the health harms caused by many individual pollutants is not strong. Many of the professionals I spoke to when researching this report, however, raised real concerns about pollutants; and we must remember that the absence of evidence is not evidence of absence. To me this highlights the need for better systems of monitoring and surveillance across a range of different pollutants.

These data systems will build resilience to the new, currently unknown pollution threats, and impacts on human health. They will help to fill knowledge gaps highlighted in my report, such as the impacts of light pollution on human health. I note there is increasing public and policy concern about the impact of computer/smartphone screen use, and ‘blue light’, upon human health. Research is on-going and this is an important area of investigation, particularly given children’s use of social media via smartphones, increasing their exposure to potential risk.

Recommendation 18

I recommend that Public Health England works to bring together all of the routinely produced data on the health impacts of pollution and the surveillance of pollution (including data held by local authorities, the Environment Agency and others), to ensure availability for the public, public sector and researchers.

Recommendation 19

I recommend Public Health England develop and embed a formal, structured programme of surveillance on the health impacts of pollution and regularly publish findings.

Recommendation 20

I recommend Public Health England explore the creation of an English health bio-monitoring data set, which includes human exposure to pollutant and health outcomes, and report publicly on their findings.

Changing the ways we work and do research

Trans-disciplinary working and research

Across the response to the health impacts of pollution and in all areas where action can be taken, I encourage consideration of the framework I suggest for pollution above. Action to reduce pollution is action to prevent ill health. Whilst it is always good for policy makers to think and then work in a joined-up way and multidisciplinary way, pollution is so complex that here it is an imperative (exemplified by the multi-faceted, successful response to lead pollution – see Box 4).

As well as changing how we think about pollution, and the data we gather, we also need to think about the way in which health professionals and researchers work. Aligned to the data issues explored above, we need more linked-up, trans-disciplinary research. Until now researchers into the health impact of pollution found they do not fit into funding structures. Too often these structures follow an old framework, with pollution being considered as an environmental hazard rather than as a broader health issue. As an example, if pollution is a driver of NCDs (as demonstrated for air pollution) then researchers in this field should be able to easily apply for biomedical research funding.

Research is often funded and organised in terms of the methodology or research tradition. This will not be enough to understand the health impacts of pollutants: this is going to need evidence from different disciplines, including epidemiology and toxicology. Researchers need to be supported to work in trans-disciplinary ways, examining the health impacts of pollutants. Once the systems are in place, the researchers and research disciplines must work together in order to fill these evidence gaps. Different disciplines working on the same pollution problem, then synthesising these different type of information, will be the best way to answer the question of what the health impacts are. I believe that the new UK Research and Innovation (UKRI) will support a more trans-disciplinary research landscape: this must benefit work to understand the human health impacts of pollution. Shifts in funding, attitudes, and structures are required at the university level too if we are to fully understand the health impacts of pollution.

Recommendation 21

I recommend that UKRI convene a working group on the integration of health and pollution data. The Group should

- a) include Health Data Research UK, other relevant bodies, and government Chief Scientific Advisers;
- b) review existing data coverage; review methodologies for linkage of data sets; and explore new opportunities for joined up data; and
- c) ensure data reviewed includes, as a minimum, data concerning the health impacts of pollution, socio-demographic data and pollution data.

Recommendation 22

I recommend research funding and structures should be put in place which encourage research on the long-term impacts of low-levels of pollutant exposure on human health. These research structures should facilitate focused multi-disciplinary research into health and pollution.

Communication

Through all of this, there needs to be better communication with the public about the extent to which we understand health risks, what these risks are (including risk factors for NCDs), and what can be done. There are many skilled people working hard on this agenda already. Further, communication around pollution and health does not need to reinvent the wheel; we can draw on many other fields to understand what works. Relative risks can be challenging for some people to understand, and many of us remain under-equipped to make fully informed decisions about pollution with regards to their and their families' health. Public health professionals play a key role in describing risk levels to local pollutions in layman's terms, whether to allay fears or warn of unsuspected harms.

The recognition of the wide range of sources of lead exposure coupled with the implementation of strong mitigation measures were the key to the resolution of this major public health issue.

Box 4 Lead pollution – a pollution success story

Prof Roy Harrison, University of Birmingham

Lead was long recognised as a substantial hazard for workers in the lead industry - with limits enforced. In the 1960s epidemiological studies revealed that exposure to lead at environmental concentrations, far below those experienced in industry, were leading to impaired IQ development in children.

Lead is a multi-media pollutant with significant pathways for exposure through:

- The atmosphere. By far the greatest respiratory exposure for the majority of the population arose from emissions from road traffic.
- Drinking water. Although most sources of drinking water were low in lead, lead could be picked up in the distribution system, especially from household lead pipes.
- Soil and dust. Urban and roadside soils were heavily contaminated with lead, largely due to emissions from road traffic. Indoor dusts could also be heavily contaminated by outdoor dusts and from leaded paintwork. Old paints frequently contained a very high lead content, leading in some cases to clinical symptoms of poisoning in exposed children.
- Food. Foodstuffs contained lead from a range of sources, most notably atmospheric deposits to food crops and the use of leaded solders in cans.

Faced with many exposures, the response had to be multifaceted. In 1985, the maximum lead content of petrol was reduced and the subsequent introduction of unleaded petrol led to a huge decline in airborne lead concentrations. Drinking water from sources most liable to dissolve lead was treated prior to distribution to suppress lead solubility, which together with widespread replacement of leaded pipework, led to a substantial reduction in drinking water lead concentrations. Limits were introduced on the lead content of paints. The use of lead in food cans was phased out, and this together with a reduced input of lead into unprocessed foodstuffs led to a dramatic fall in dietary exposures.

Lead levels in soils and dusts have responded slowly to these actions. As a result, population blood leads have fallen dramatically, as have cases of clinical poisoning. Blood lead levels in UK children fell from 140-360 $\mu\text{g L}^{-1}$ in 1964 to around 37 $\mu\text{g L}^{-1}$ in 1991-2 and have fallen further since. The recognition of the wide range of sources of lead exposure coupled with the implementation of strong mitigation measures were the key to the resolution of this major public health issue.

Summation and chapter summaries

Below I summarise the contents of each chapter of my report.

Summary of Section 1 ‘21st century threats’

Chapter 2 Pollution from the health and care system

Chapter 3 21st century chemicals

Chapter 4 New horizons

Instead of listing the traditional media where pollution is found, air, water, land etc. and their associated health impacts, this section presents a number of the threats from pollution that we currently face and potential solutions. We explore the polluting impact of healthcare as an example and how the NHS can be part of our answer to reduce pollution. We are faced with changing chemical threats and we explore some of the newer – and potential future – threats from pollution.

Chapter 2 Pollution from the health and care system

As presented throughout Chapter 2, our healthcare system, the NHS, is a source of pollution. Our duty of care to our patients has, to date, not extended to how we run our NHS in terms of the health impact of its pollution footprint. This concept of environmentally sustainable health systems has recently gained greater international focus.^{vi,vii} WHO guidance echoes key themes presented in Chapter 2: minimising waste, using efficient procurement, prioritising prevention, and others. These are all required to switch the health system from having a negative to a neutral or positive environmental impact.

Five percent of all road traffic at any one time is estimated to be on NHS business, be it patients going to and from care or the NHS's fleet of vehicles. This will be reduced if the right care is provided in the right place – using models of care with least amount of travel. Taking care to the patient will be part of this, so there is a role for us fulfilling the potential that technology has.

There is limited direct evidence of the health impacts of other forms of waste in the NHS, although the continued use of landfill and incineration must have some. There are ways to stop this – which will also improve NHS finances. It will not be sufficient to recycle; we need to reduce waste produced: reduce unnecessary healthcare, and ensure more efficient procurement.

Healthcare should be responsible for the pollution footprint of its supply chain. Gaps in knowledge and environmental monitoring remain. Reducing pharmaceutical pollution – notably through waste and overprescribing reduction – has co-benefits (for finances, patients and others). Healthcare, and more significantly agriculture and aquaculture, contribute to the overall quantity of pharmaceuticals in the environment. Environmental antimicrobial pollution is a cause of antibacterial resistant bacteria, although the exact degree remains unknown

vi WHO 2017 Environmentally sustainable health systems: a strategic document
vii WHO Europe 2017, Sixth Ministerial Conference on Environment and Health

Chapter 3 21st century chemicals

Chemical mixtures are the norm in the environment, and these mixtures are growing increasingly complex. Constituent chemicals within these mixtures are mostly at a low concentration, with any one chemical unlikely to harm health on its own, but with less known about the health impact of the mixture.

Large datasets, new epidemiological techniques, geospatial methods, 'omics', genetic approaches, and others will help us to better understand the threat posed. We cannot rely solely on observational sciences, be it to study mixtures or individual chemicals. Experimental studies will be critical, notably toxicological studies. These must focus on the substances of concern to human health, providing evidence to be collated with observational data to give the most accurate picture of health impacts. They also need a real world focus, focusing on levels of exposure faced by humans.

In addition to new chemical threats, another change will be reassessing 'legacy' chemicals using 21st Century techniques. Metals are an example, one of the oldest legacy exposures, but whose risk can be revisited. This could include using genetic data to better understand and highlight individual susceptibility.

Some chemicals have been the subject of persistent discussion in terms of their health impact. These include dioxins, endocrine-disrupting chemicals, Bisphenol A, phthalates and others. Some of these have well defined hazard profiles, but exposures are believed insufficient to cause risk. Others have associations with diseases, but this has not been proven to be causal. These chemicals require vigilance. The chapter author suggests specific research examining causal links between concentrations of chemical and health outcomes, rather than associations.

A particularly understudied area is the impact of chemicals on the genome and epigenome – the consequences of which could have intergenerational impacts. There is currently little evidence around this.

Chapter 4 New horizons

This chapter explores pollutants that are newer, or are less well established in terms of the evidence of health impact. It discusses some of the newer techniques to study and respond to the health impact of pollution.

Noise stands second to poor air quality in terms of the burden of ill health caused by a single pollutant, and is increasingly high on the international agenda. Over 80 percent of people report being exposed to noise pollution in their homes. Links to ill health include, proximally, sleep disturbance and stress, with more distal associations with hypertension, cardiovascular disease and children's learning development. Research may identify causal relations with the latter measurable health outcomes. Addressing noise level retrospectively can be costly – it is better to consider noise pollution in planning decisions.

Other proposed threats are either far less well established or appear to have more limited impact. Light has some known effects on the body – but whether this extends to light pollution having health impacts is not known. Nanomaterials are a new and exciting technology, with many applications. These will pollute and will penetrate the human body due to their size. These need to be examined as emerging chemicals. With very limited information on any adverse health impacts, we must maintain a targeted watching brief – one that is interdisciplinary, with particular focus on exposure assessment. This summary of nanoparticles could well be repeated for micro plastics – with no current evidence of adverse human health impacts, there is a need for coordinated multi-disciplinary assessment.

New techniques and technologies, many of which are likely to be revolutionary across biomedicine, will play an important role in our understanding of the health impacts of pollutants. Advances in epigenetics, the understanding in the way genetic information is used, promises to increase our understanding of how pollution causes ill health. Meanwhile, genome sequencing tumours may allow us to pinpoint their environmental – pollution – cause. Not all advances are new technologies. Older traditions, such as epidemiology are also innovating to further our understanding of the health impacts of pollution.

Summary of Section 02, 'Socioeconomic world'

Chapter 5 Economics of pollution interventions

Chapter 6 Pollution and inequality

The next section of my report addresses how pollution, a facet of the physical environment has interrelationships with social and economic thinking about health. This ranges from how pollution is a factor that adds to health inequalities, to how we examine the impact of interventions to reduce exposure to pollution through a health economic lens.

Chapter 5 Economics of pollution interventions

Economics and economies play a pivotal role in all of health. Chapter 5 presents evidence of the health economic evaluations of interventions to address pollution in England (or that are of relevance to England). In addition to this, there are many other questions that arise from considering together human health, pollution and economics. These include assessing the cost of the health impacts of pollution; the relationship between economic growth, pollution production and associated ill health, as well as the insight economics gives around changing polluting behaviours, and others.

Our best estimates of the overall cost of the health impact of pollution are likely to be underestimates. There are a number of reasons behind this, presented in the chapter. For one, we have far less evidence about the impact pollution has on morbidity and quality of life – compared with mortality – which are major drivers of cost. More work is required to get a fuller and more accurate measure of cost of ill health from pollution; this will help to stimulate an appropriate policy response.

This chapter is informed by a systematic review of the health economic evaluations of interventions to reduce pollution. Although some actions have been shown to be beneficial from a health economic perspective, the review highlighted the gaps in evidence. This evidence base needs to be expanded, with results presented in a way that makes it easy for decision makers at a local and national level to implement the evidence based options.

Evidence is presented that many decisions made in England, across all geographies, have an impact on health through pollution but do not take into account the health economic impact. A major reason for this is that the evidence of health economic impact or modelling of potential impact is not included in the decision making process. For example, an economic assessment of a transport decision might account for the cost of the infrastructure, the financial gain to business and industry, but not the health economic impacts.

Chapter 6 Pollution and inequality

This chapter collates the evidence around pollution and health inequalities, and considers the implications.

If we use the simple ‘source-pathway-receptor’ model that describes how a pollutant can get from ‘the environment’ to cause health harms, there are plausible inequalities across the whole pathway. In terms of evidence in England, much is focused on air quality and the differential exposure by socio-economic position. Here, there is growing consensus of a U-shaped exposure to raised mean concentrations (lowest exposure in rural areas which tend to be in the middle of the socioeconomic gradient); and of a linear relationship between exposure to short term exceedances of air quality targets and deprivation (more exceedances in the most deprived). There is much more limited evidence of other types of inequality, such as by ethnicity, gender or others, and of inequalities in exposure to other pollutants.

The chapter discusses ‘triple jeopardy’: a concept that states that:

“disadvantaged groups face: first, increased risks from social and behavioural determinants of health; second, higher risks from high ambient pollution exposure; and, third, an effect modification that makes exposure to ambient pollutants exert disproportionately large health effects on them compared with advantaged groups”.^{viii}

This implies an interaction between the pollution and socioeconomic position – through an underlying susceptibility, therefore more severe health outcomes for a given ‘portion’ of pollution exposure. This is intuitive, but the evidence is not yet clear (although there are some suggestions), and is certainly not showing a consistent, large impact on clinically meaningful outcomes at present.

The evidence base of health inequalities associated with pollution in England is also restricted by a number of limitations. A major weakness is the use of area level data rather than individual-level (while area-level data remains helpful and hypothesis generating) Combining data, including pollution exposures, health outcomes and rich socio-demographic data will allow better understanding of this relationship. This matters because addressing health inequalities is a priority in England. There is one question of particular importance: do our wider efforts to address the health impacts of pollution have positive, neutral or negative impacts on health inequalities?

^{viii} Jerrett et al. 2001. Environment and Planning A, 33(955-973)

Summary of Section 3, ‘Our human response’

Chapter 7 Environmental and health service pollution

Chapter 8 Environmental pollution - data, surveillance and health impacts

Chapter 9 Measurement and communication of health risks from pollution

The last section of my report covers three areas where we have addressed, and need to do more to address, the health impacts of pollution. The three areas might not appear to be direct responses to pollution but are important and share a number of facets: these areas are a) not specific to any one pollutant, b) collaborative, and c) strive to ‘join up’ our response. These are not a series of interventions and solutions, examples of which are given through the whole report. Nor are these exhaustive, answering all threats to all pollution. Good work in these and other areas will make lasting and fundamental changes to our health in England.

Chapter 7 Environmental and health service pollution

Chapter 7 explores how those working across environmental health are faced with the health consequences of pollution on a daily basis. Specialists in environmental health, and all allied practitioners working to curb pollution, are a vital resource to improve the public's health and prevent chronic disease.

The environmental health workload can often be at the acute end of the response to the health impacts of major pollutants. As well as working to control the immediate acute health impact of pollution, the chapter describes how environmental health professionals engage in proactive and preventive work. They can use their considerable expertise in the planning processes, for housing, transport and more, to create an environment where it is easy for the public not to pollute nor be affected by pollution. Practically, the skills and responsibilities to do this locally now lie in one place – local authorities.

Polluters often do the minimum to reduce their health impact, often just meeting legal requirements. The chapter explores the need to forge an environment where individuals, institutions and public bodies find it easy not to pollute – where making the no/low pollution choice is the norm, and where pollution levels are reduced as far as possible to improve health. It describes how this will require the provision of information to aid decisions, real leadership and structural changes to make the 'right' choice easier.

Many pollutants are continually produced as we live our daily lives. Other pollution events are sporadic and short lived. Fire reduction represents a great success, although there is more work to do. Fires produce acute, high concentrations of poor air quality. Reductions in fires associated with the waste disposal sector (where risk has increased with recycling) represent an excellent example of the multi-agency, multi-sector working that is needed to prevent pollution and prevent ill health.

Chapter 8 Environmental pollution - data, surveillance and health impacts

This chapter discusses the difficulty of studying and monitoring the health impact of pollution.

There is a proliferation of data, across pollution exposures and health outcomes, 'Joined-up data' increases size and richness of datasets, and can add a longitudinal component – all of which increases the 'power' of these data to answer question about the health impacts of pollution. Achieving this needs close collaboration and partnership between many institutions, the health sector, national and local government, academic and others. Data not only need integrating but also needs to be published, whilst ensuring that appropriate governance procedures remain. Access, particularly to routine monitoring data, must be fast enough to respond to emerging health threats from pollutants.

The UK is well placed to remain a world leader in understanding pollution; methodological advances could allow us to capitalise on existing datasets to improve our knowledge.

Biomonitoring has great potential to transform how we gather knowledge on the health impacts of pollutants. Using biomarkers means we can overcome difficulties in relating environmental pollutant concentrations to the exposure faced by individuals: they can give us an exact, person specific measure. When combined with health outcomes we can improve estimates of risk from pollutants and strengthen causal inferences to ill health. Internationally, biomonitoring data sets have provided valuable insights, and the chapter describes how an annual biomonitoring dataset would help us examine current and future pollutant threats, protecting the public's health and monitor our actions.

In England we have an excellent and comprehensive set of surveillance systems for most infectious diseases. NCDs, however, do not yet receive the same attention in terms of surveillance. Environmental public health tracking, a set of techniques to carry out surveillance of the NCDs caused by pollutants, could fill this gap.

Chapter 9 Measurement and communication of health risks from pollution

This chapter expands on the difficulties in measuring the health risks from pollution, and the challenge of communicating risk levels.

It is important to remember the context in which pollution sits when considering its health impact. Most pollution arises out of an activity that someone chooses to do: therefore there is always some inertia to maintain the status quo. Practically, this means we must be confident (not necessarily precise) about the health impact of a pollutant. We must then communicate this in an impactful way in order to elicit changes (a necessary – not sufficient requirement).

One question, across pollutants, is understudied; what is the balance in harm between short term exposure to high level and long term exposure to lower levels of pollutants? This has an obvious implication for measuring the total burden of pollutants, but also has implications for the policy response. The fastest way to address one type of exposure may not address the other. This chapter discusses the advantages collaboration across disciplines provides when trying to establish causation, and trying to synthesise results.

There is an existing body of evidence – often not from the world of pollution itself – to draw on upon when communicating risk. Valuable insights can be provided. For example, risk perception theory shows us the value of the emotive communication, and behaviour change theory highlights the importance of self-efficacy^{ix} in making changes.

The chapter describes other facets of successful risk presentation and communication. It explores openly stating both confidence in, and precision of, best risk estimates as a way to overcome the uncertainty we have around risks of pollutants, without compromising action. This openness and using emotive messages are two lessons for pollution risk communication.

^{ix} Bandura described 'self-efficacy' as a personal judgement of "how well one can execute courses of action required to deal with prospective situations." Bandura, A. (1982). *American Psychologist*, 37(2), 122-147

Chapter 02

Pollution from the Health and Care System

Chapter lead

David Pencheon¹

Chapter authors

David Pencheon¹, Andrew R H Dalton²

1 Honorary Professor, Health and Sustainable Development, Medical School, University of Exeter Medical School

2 Public Health Specialty Registrar, *West Midlands* Deanery

Introduction

Healthcare can do much to improve health. The financial cost of healthcare should be seen mostly as an investment; the environmental cost should mostly be seen as avoidable.

Not only can healthcare systems be disproportionately polluting, but they have special responsibilities and opportunities to be exemplary in not causing avoidable harm. There are many reasons why the health service pollutes:

- the size of the sector – small relative increases in efficiency or decreases in waste have high absolute consequences;
- the toxicity of many products used – many diagnostic reagents and the interventions (for example pharmaceuticals) are novel agents and therefore can have unexpected and polluting consequences on the environment unless rigorously and systematically tested.

Every healthcare practitioner has a duty to do no harm: “primum non nocere”. The same principle should be applied to healthcare systems such as the NHS. The financial cost of waste and human cost of pollution caused by the NHS means we need to factor this into how we design and deliver models of prevention and care. It is counter-productive to provide healthcare in ways that pollute the conditions that create and protect health.

For instance, the NHS is now responsible for almost one in 20 of all vehicles on the road.¹ Reducing the fossil fuel transport within the NHS creates multiple health benefits: reducing air pollution (PM/NOx); promoting physical activity; and the reduction of climate change inducing greenhouse gases – all of which have additional beneficial health effects, both immediate and long term. A 3% increase in uptake of active travel by NHS staff in England, for example, would mean healthier staff, saving over £265m in avoided health treatment costs and improving health by 114,000 QALYs.²

Healthcare's role in pollution: part of the answer

The NHS (both practically and symbolically) has a special role in not only curing disease but also in prevention. This translates into a responsibility to measure and address the preventable pollution for which the NHS is responsible: from toxic waste, to air pollution to greenhouse gas emissions. Examples of how the NHS contributes to pollution include;

- business mileage and the movement of ambulances in 2016 by NHS providers alone equates to around 680m miles per year, creating 517 tonnes of NO_x and 27.3 tonnes of PM 2.5, this equals a health impact cost of over £15m per annum.;³
- annually NHS providers spend over £540m on energy which equates to the release of 3.7 million tonnes of CO₂. There are still NHS providers burning coal and oil at health sites; both are very carbon and pollutant intensive fuels, with 176 gigawatt hours of energy from these in 2016.

The NHS in England spends approximately £16bn per year on prescribing drugs, much of which is disposed of in uncertain ways, either before or after being administered. Not only does this result in great financial, but it is unclear exactly what the long term polluting effects of pharmaceutical might be on the environment.

Some level of pollution is inevitable in most health care activity. Much harm, waste and pollution can therefore be eliminated by reducing avoidable and unneeded health care by addressing over-diagnosis and over-prescription (supporting efforts to, for example, reduce over use of antibiotics). This is in addition to traditional waste reduction such as throwing away excess packaging, unused open packets etc. Waste extends to over diagnosis and over treatment.⁴ An estimated 20% of clinical practice has no benefit to the patient – whilst there is significant overuse of tests and interventions.⁵ Addressing waste produces higher value healthcare, providing more care for a given ecological footprint. Efforts to reduce waste – and pollution – also extend to having a much more strategic and ambitious approach to prevention: as the Prince of Wales said in 1891, “If preventable, then why not prevented”.⁶ Preventing ill health has the added co-benefit of reducing the need for future treatment – with its associated environmental impacts.

As responsible stewards, doctors can provide a more effective use of constrained economic and environmental resources.⁷

Crucially, this response should be done in a way that frames pollution as a direct health risk. It is much better to frame the pollution (for example diesel exhaust) as an immediate **health** risk, not simply as a distant **environmental** risk – a cause of non-communicable diseases just as smoking, obesity etc. are.

There is increasing evidence to suggest that, with sufficient will, the polluting ecological footprint of the health service in England could be substantially reduced – and in ways that would both strengthen the principles and goals of the NHS, and alongside deliver numerous other immediate and long term gains for health and wellbeing.⁸

Pollution and finances: “a convenient truth”

The link between financial sustainability and environmental sustainability is a highly convenient truth, and an opportunity the system should seize. Much pollution caused by the health system is due to wasteful practices that generate harm to the environment (and in turn to the public and patients), waste money (and other finite resources), and jeopardise safety. Understanding the scale of the problem and the opportunity for improvement brings significant, multiple benefits for the health of both current and future generations, as well as preserving those resources now.

An example at the most critical part of the system – hospital admissions – shows that some enlightened hospital systems assess every unplanned admission to quantify the degree of preventability, and thus the unnecessary activity, cost, harm, waste and pollution caused. This can be repeated across all other aspects of the health system. A population or public health approach to care⁹ (as practiced by systems such as Kaiser Permanente in the USA) can significantly reduce unnecessary and wasteful care, thus reducing harm and pollution.¹⁰

Given the multiple benefits of actions to reduce waste in the health system – reducing pollution, as well as reducing costs and harms, there have to be significant barriers to their implementation. The NHS is largely “funded for activity”, not for outcomes. There are unintended perverse incentives in the system: hospitals are rewarded for more activity and thus have very little incentive to invest in preventative programmes that improve health and avoid unnecessary care with the associated waste and pollution. Systems with a clear environmental and waste reduction policy include Kaiser Permanente in the United States. Here financial outcomes and the health outcomes are aligned – encouraging prevention and promoting care, where appropriate, in the community, reserving hospitals for what only they can do.

Pollution in the health and care system

Three specific examples are considered here as they fulfil the important criteria of being widely understood and measurable, and areas where action is possible and effective.

Travel and air quality

The health system in this country, like in nearly all countries, is large (employing over 1.2 million people in England – the fifth largest employer in the world), reaches every town and community in the land, and involves the movement of many goods, services and people. The movement of staff, patients, visitors, and the coordination of logistical support for the health service means that approximately 3.5-5% of all road traffic at any one time in England is estimated to be on some sort of NHS business.¹¹

Much of this is avoidable if we are to bring the right care to the right people at the right time. We need to understand that there is a price to pay for this scale of transport and travel, not just in terms of time or money but in terms of air pollution (NO_x, PM₁₀ and PM_{2.5}) and greenhouse gas generation. Because no-one pays **today** for the true, full social cost of fossil fuel use and pollution (much of the cost is deferred to the future) and because large hospitals are fixed and immovable assets, we focus much of our specialised care there. These contain a critical mass of expertise and equipment but mean that our models of prevention and care are largely centralised.

Table 2.1 Air quality and the NHS fleet, 2016

Sources of air pollution in England from travel	Miles (million)	CO₂e emissions (t)	PM2.5 (Kg)	Nitrous Oxide (NOx) (Kg)	Total health and non-health impacts (£)
NHS providers and Ambulance Trusts (Business mileage, ambulance fleet, patient and visitor travel and staff commuting)	7,231	1,067,713	237	5,232	£646,427,991
Primary care and commissioners (Business mileage, patient and visitor travel and staff commuting)	1,976	426,008	61	1,319	£142,461,818
Total	9,208	1,493,721	299	6,551	£788,889,810

Source created using information from *Health Outcomes of Travel Tool; a modelling tool for the harm; air pollution, noise, GHGs and accidents from all travel in the NHS including all business mileage and ambulance fleet*, available at <https://www.sduhealth.org.uk/>

Box 1 Personalised Care for Lung Fibrosis Patients: Reducing unnecessary travel

Idiopathic Pulmonary Fibrosis (IPF) is a condition that causes progressive scarring of the lungs resulting in shortness of breath, leading to the need for extra oxygen. Treatment is given to relieve symptoms and to try to slow progression. University Hospitals North Midlands (UHNM) University Hospital is a specialised centre for the management of patients with IPF

The issue?

It is only in the past few years that drugs have become available to treat IPF. These can only be prescribed by specialised centres. These drugs have side effects for which patients require close monitoring and regular clinic visits and assessments. As a specialist centre for IPF, UHNM sees patients referred from a large area across the Midlands and Wales. For some patients this means a lot of traveling. Patients with IPF can also require prompt support, especially as the disease progresses. This is usually provided in close collaboration with the patients' carers, local community and hospital-based respiratory services. Thus communication between all parties has to be effective.

Action taken

To address the issues of frequent clinic attendances in person and prompt intervention to support patients, the team in Stoke have developed a bespoke 'app' – accessible by phone, tablet or computer - on a secure hospital website. This allows patients to track and report their symptoms from home instead of attending the hospital in person.

The patient-generated reports are reviewed by the clinical team daily, who can then guide the patient/carer. The app includes the patient's history and co-morbidities. Functionality is especially useful to enable patients to recognise symptoms and drug side effects. It also supports patient/carer participation in the management of their disease with real-time communication between them and the clinical team avoiding the need to make unnecessary visits to the hospital clinic.

The impact?

There are currently over 250 IPF patients at the trust. Although the app was only recently launched over 50 patients are using it. This can mean a reduction in appointments of up to 50% meaning a saving in carbon costs as well as better outcomes for patients. The trust is hoping the project will enable a reduction to two visits a year for the mild to moderate disease and four visits for severe.

continues next page

Lessons learned

- Internal testing was required to ensure patient safety and the suitability of the application
- A simple user guide was produced;
- Security of the system, data entry and confidentiality were addressed by entry protection on the Trust website;
- The application can be used on a variety of devices for example smart phone, tablet, laptop or desk computer according to patient preference;

Scaling up

Replication of this application is possible across other specialist centres in the NHS and for other conditions. The trust has received funding to develop a similar self-management system for Chronic Obstructive Pulmonary Disease patients. The clinical team are also currently in talks with commercial parties to roll-out the applications across the wider NHS economy.

Despite the extraordinary growth of person-held ICT, the miniaturisation of near patient testing, and the potential savings from such developments, there is little evidence that care is being taken to the patient. Consequently, our ability to invest in modern ICT systems, prevention, care in the community, powering public, patients, and primary care is all hindered by the centralisation of healthcare facilities. This results in such a high proportion of road traffic being on NHS business which contributes to air pollution, wasted time, higher risks of road injury and community severance⁺⁺⁺, all of which adversely affect health. Figure 2.1 describes how investment in sustainable transport can affect improved health.

The health service has an important opportunity to be a part of the solution to the pollution challenges we face, not part of the problem. Moreover, health services and health professionals have an important responsibility to visibly show that they take their contribution to air quality (and other issues such as climate change seriously). Some hospital Trusts, Bart's NHS Trust in East London, and Great Ormond Street Hospital, for example, have specific programmes to reduce the damaging effect their activities have on air quality through reducing their energy use, stopping ambulance idling, other fuel efficient driver training and increasing zero carbon forms of transport in patients.

⁺⁺⁺ 'Community severance' (also known as 'the barrier effect') is a term to describe transport system interference with people's mobility and ability to access goods and services e.g. heavy road traffic impeding local people's ability to navigate their neighbourhood by foot.

Figure 2.1 Virtuous cycle of investing in sustainable health and sustainable transport

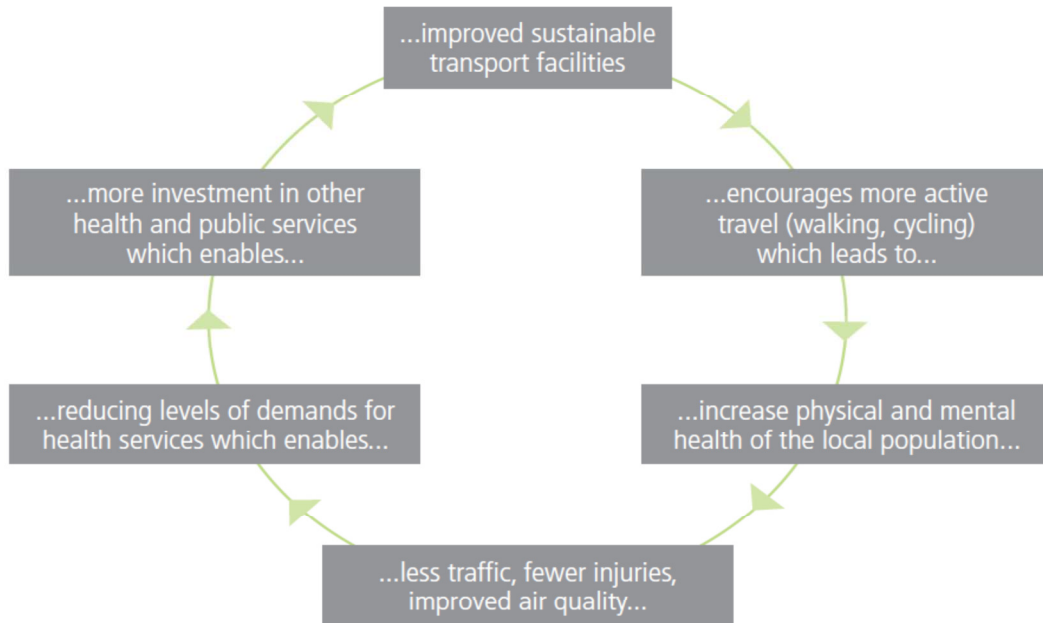

Source 2009 NHS Carbon Reduction Strategy¹²

Author's suggestions for improvements

- All hospitals could have travel plans as part of their Sustainable Development Management Plans (SDMPs) including:
 - Plentiful active and low carbon travel opportunities to and from health facilities (walking, cycling, public transport etc.);
- Energy strategies in the NHS could consider non-combustible renewable heat and co-generation (for example fuel cell combined heat and power), the use of renewable source electricity (either by generation on site or through energy contracts) and District/Community Heating Schemes:
 - This should include restricting use of energy resilience equipment. It should be used for energy resilience, where necessary, but not for short term financial gain through incentivised combustion of heavy polluting fuels to support the national grid.
- The NHS could adopt innovative models of prevention and care that allow patients and staff to travel much less whilst receiving high quality care (telecare, long term condition monitoring, virtual clinics, specialists in primary care settings);
- All action to reduce pollution in the NHS could be elevated from “expectations” to “must dos”. This requires complete buy-in and adoption from the regulatory agencies such as Care Quality Commission, NHS England, NHS Improvement, Department of Health and Social Care and National Institute for Health and Care Excellence.

Box 2 Reducing our emissions for sustainable healthcare is Care Without Carbon

Hayley Carmichael and Will Clark, Sussex Community NHS Foundation Trust

Sussex Community NHS Foundation Trust spans 1,000 square miles, employing almost 5,000 people. Delivering care in homes and across over 70 sites will always involve travel. However, we believe that minimising that travel is essential for the delivery of sustainable healthcare. For us, sustainable healthcare is about more than saving money, it is about reducing our impact on the environment, improving wellbeing for our staff, and ultimately our patients. To achieve this we created our Care Without Carbon (CWC) strategy.

Tackling local air pollution, through the reduction of our vehicle emissions is one way that CWC is making a difference. The aim is to reduce travel to its lowest possible level, while also encouraging take up of low/ zero emission, low carbon and active travel alternatives.

Firstly, we set up a travel bureau to support our staff in making fewer, cleaner, journeys. The travel bureau offers local public transport guidance, season ticket loans, a cycle to work scheme and route planning for drivers. Secondly, in tandem with the travel bureau we introduced a low emission pool car and lease scheme for staff, and even electric bikes.

A practical and effective solution

When Gina Cooper took on a new role at the Trust as a Patient Advice and Liaison Service (PALS) support worker, it required her to travel many more miles for work than before. Without a vehicle, the long public transport journeys would have been an excessive time burden and impractical.

“I don’t own my own car, but the new role demanded one. With pool cars, I didn’t have to buy a car. Instead I’m now travelling up to 120 miles a week, often to several locations a day from the base. The pool cars are hybrid, so very efficient to run, and at least twice a week I car-share with colleagues to different locations – a requirement of using the scheme is that we share travel wherever possible, I’ve saved over 700 car miles through car sharing so far.”

continues next page

An approach that works

We have increased our low emission pool fleet (vehicles available for staff use from key sites) from 13 to 21 vehicles - available at six sites. This has: cut our grey fleet mileage (staff using their own cars for Trust work) by 826,000 miles, helped us to reduce local air pollution, our carbon footprint, and given a healthy return on investment on each vehicle.

Since 2010 we have reduced our overall travel carbon footprint by 24% - on track to meet our 2020 target of 34%. Although the quantity has not been modelled, this will also reduce other air pollutants. As part of this, we have cut the engine emissions from our owned and leased fleet by 26.4% down to 111.1 gCO₂/km.

Pharmaceuticals and medical supplies: waste and post use toxicity

Pharmaceutical products cost the NHS in England more than £15 billion a year. This accounts for almost one-fifth of the total NHS carbon footprint.¹³ With the current ways in which drugs are prescribed, huge quantities are never used or never have any positive therapeutic benefit.¹⁴ Further, these can then enter the environment and pollute. Critically, there is currently no evidence of harm to humans from non-therapeutic exposure to pharmaceuticals in humans (of which pollution is one constituent part). Indeed for one method of exposure, ingestion of drinking water, in 2012 the WHO concluded that:

“Trace quantities of pharmaceuticals in drinking-water are very unlikely to pose risks to human health because of the substantial margin of safety between the concentrations detected and the concentrations likely to evoke a pharmacological effect.”¹⁵

There is room for vigilance, and some unanswered questions – and this is only an assessment of harm from a human health perspective. There is evidence of some harm from pharmaceutical pollution not associated with direct human exposure – notably from antimicrobials in the environment (more below).

Active pharmaceuticals and their metabolites do enter into living systems and the environment,¹⁶ through a number of routes (Figure 2.2). Two of these – from human excretion of therapeutic drugs, estimated to be the major source of pharmaceuticals in the environment;¹⁷ and from drugs not taken and inappropriately disposed of – lie ‘within’ health care. The former is inevitable, but can be reduced by appropriate use of medication (stopping overtreatment), whilst the latter can be stopped through correct disposal and providing correct quantities of medications. In terms of disposal, England by law (European Directive 2004/27/EC) must have appropriate schemes to manage unused pharmaceuticals. In England, household pharmaceutical waste disposal is provided by pharmacies. Medicines are still disposed of in uncontrolled ways,¹⁸ although the implications for active pharmaceuticals in the environment depends on the route of disposal (for example if incinerated – they will not enter the environment). Other routes into the environment, such as the manufacture of pharmaceuticals, are in the supply chain for healthcare: others still, such as farming livestock, crop production, aquaculture, and others lie outside of healthcare – and outside of the scope of this report.

The nature of pharmaceutical pollution will not be static through time, nor does it occur in the absence of other threats. Demographic changes are likely to increase the prevalence of long term conditions such as Type 2 diabetes: with more people relying on maintenance drugs, the pollution burden will steadily increase.¹⁹ Pharmaceuticals are also parts of chemical mixtures; therefore any health effects need to be examined in the presence of other chemicals and stressors.

Figure 2.2 Occurrence, sources, and fate of pharmaceuticals in the environment

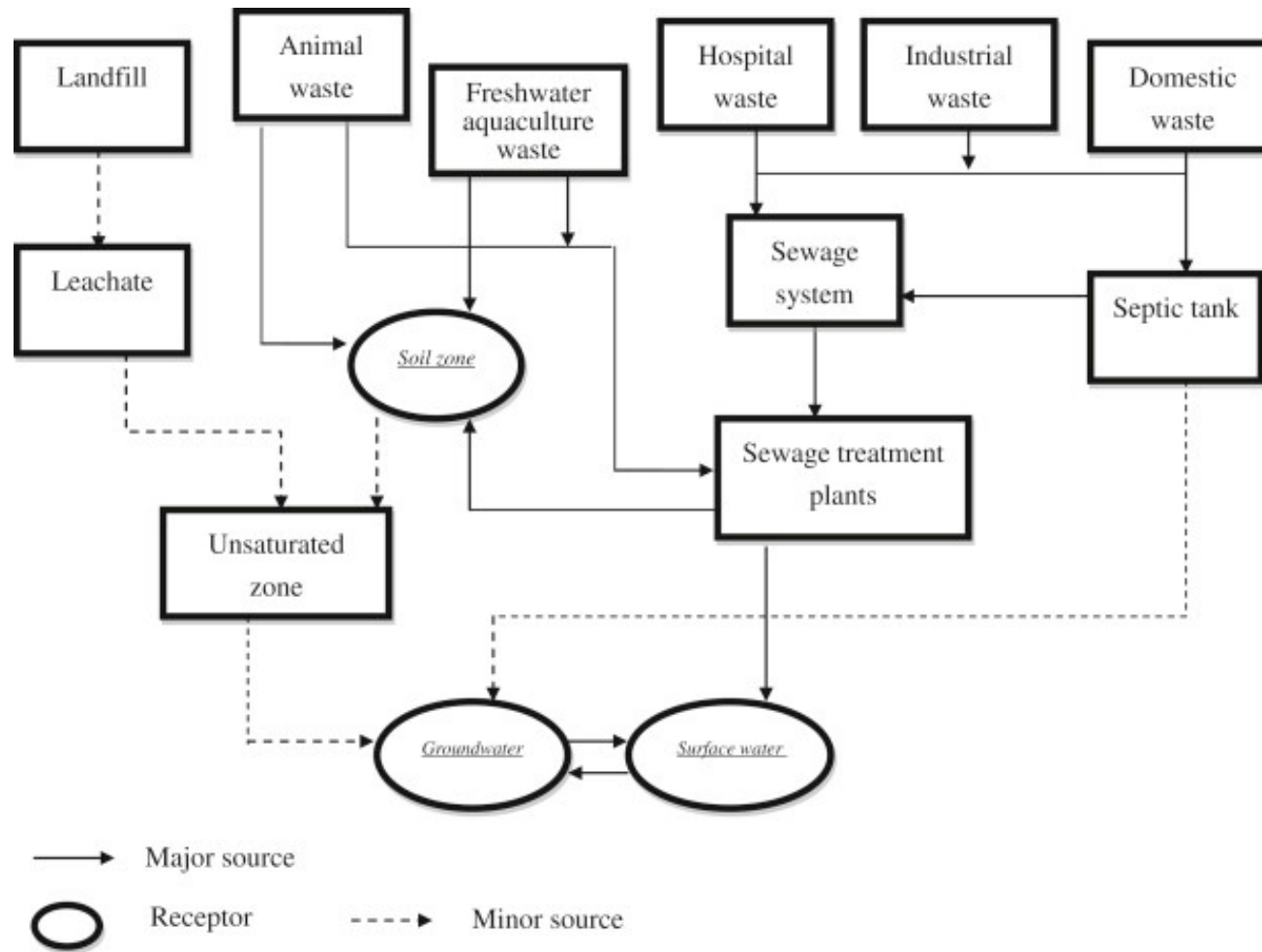

Source adapted from Li, W. 'Occurrence, sources, and fate of pharmaceuticals in aquatic environment and soil'

Box 3 Health effects of pharmaceutical pollution in England

Paul Kay and Lee Brown, University of Leeds

It is now well established that pharmaceuticals used in both human and veterinary scenarios enter the environment and are routinely present in English rivers. Average concentrations across rivers are in the order of 100 ng L^{-1} , although can reach several $\mu\text{g L}^{-1}$.ⁱ Globally, higher concentrations in the mg L^{-1} range have been found.ⁱ Historically, compared to many environmental pollutants, pharmaceuticals have been monitored to a limited extent – although this is changing. More work is needed to robustly determine their occurrence in sewage and the water cycle, and critically, their fate and effects in the environment.

Even the most advanced treatment processes fail to remove all drug residues from waste and drinking water, whilst many compounds are rarely detected in potable waters. Others, such as carbamazepine, are frequently detected. All, however, at concentrations well below (orders of magnitudes) levels of therapeutic effectiveness.ⁱⁱⁱ

As for rivers and groundwaters, our understanding of pharmaceutical concentrations in drinking waters is limited to a relatively small number of research studies. It should be remembered that these substances, in contrast to many environmental pollutants, are designed to be given to humans and may not represent the same level of risk to health. Indeed, current understanding indicates that impacts in humans due to exposure to drug residues in drinking water are very unlikely, with concentrations typically being three orders of magnitude lower than the minimum therapeutic dose (MTD).^{iv}

Although the potential for health harm is low there are a number of outstanding questions before this can be fully quantified.^v It is unclear if daily exposure to sub-therapeutic doses of pharmaceuticals in drinking water, over a period of decades, will have health impacts. . Much remains to be learnt about how different chemicals interact and whether mixtures of chemicals, including pharmaceuticals, can exert effects not associated with single compounds. The effects of metabolites compared to their parent compounds are also less certain and risk assessment approaches need to continue to be developed to consider all of these factors. Pharmaceuticals are designed not to bio accumulate – therefore bioaccumulation is one route where health impacts are unlikely.

References

- i Kay, P., et al. 2017. *Environmental Pollution*, 220, pp.1447-1455
- ii Hughes, S. Ret al., 2012. *Environmental Science & Technology*, 47(2), pp.661-677
- iii Furlong, E.T., et al., 2017. *Science of the Total Environment*, 579, pp.1629-1642
- iv WHO, 2011. *Pharmaceuticals in Drinking Water*. World Health Organization, Geneva, Switzerland.
- iv Caban, M., et al 2016. *Current Analytical Chemistry*, 12(3), pp.249-257

Box 4 SIRUM: Saving Medicine – Saving Lives

Kiah J Williams, SIRUM

Industry experts estimate that 2-3% of the \$270 billion of prescription drug sold each year in the United States go unused.²⁰ The most recent, 2010, estimates place the cost of unused medicine in England at £300 million.²¹ What happens to the billions of dollars of medicine that do not reach patients who need it? Currently, incineration, landfills and waterways remain the most common destination for unused medicine, with the majority incinerated. Each fate is uniquely detrimental to our environment and potentially to health - medical waste incinerators are estimated to be the third largest producer of dioxins in United States²², whilst waterways have traces of pharmaceuticals.

SIRUM is a nonprofit company that uses an online platform to facilitate the redistribution of unused medicine - much like recycling - converting medicine destruction into donation. It collects unopened, unexpired medicine from health facilities, manufacturers, wholesalers, and pharmacies and uses an online platform to connect surplus medicine with safety-net clinics and pharmacies. The program reduces the amount of time and cost associated with disposal of unused medication, and increases access to prescription drugs for low-income patients who utilize safety-net clinics and pharmacies for their health care. The network of hundreds of medicine donors has redistributed over \$11 million worth of medicine at National Average Drug Acquisition Cost (NADAC) value, enough to fill 300,000 prescriptions.

SIRUM combats important social issues, but by preventing medicines from entering the waste stream and reducing the amount needed to be produced, it reduces pollution. According to the Natural Resource Defense Council (NRDC), the production of one pound of pharmaceutical active ingredient can generate between 200 to 30,000 pounds of waste.²³

By ensuring all medications are safely redistributed and used for their intended purpose - to make people well and keep them healthy – SIRUM believes that millions of people will get the medicine they need while dramatically reducing the environmental impact of production and needless destruction of these valuable resources.

Hospitals are a significant concentrated site for pharmaceutical products, although still likely to only make a small contribution to the overall amount of pharmaceuticals in the environment.²⁴ The primary approach has to be to reduce overtreatment, reduce unused medication and ensure correct disposal. There are far too few incentives to reduce wasted, out of date supplies that need to be disposed of. Although recycling unused drugs is hard, there are now some schemes internationally that recycle unused medicines: particularly in the United States (see Box 5). Such schemes can address the cost of waste, improve access to drugs for those most in need – and, in what is likely a small part, reduce pollution. They must also work within the legal requirements of supply – such as including a secure chain of custody.

Beyond waste reduction, although there are mechanisms to promote the removal and degradation of pharmaceuticals products from for example hospitals or wastewater treatment plants, it is not clear what the cost benefit is in relation to the possible health hazards.²⁵ Further, internationally there are different approaches to address hospital effluence. One is to treat hospital waste separately – including onsite treatment; whilst the other is ensuring waste is channelled only into central waste water treatment – then ensuring the treatment process is highly effective. For onsite treatment, in order to prevent the spread of antibacterial resistance genes (below), it will be particularly important to focus on the bacterial component of the waste, as resistance genes can mobilise and spread within and between bacterial species. Wastewater treatment systems represent a significant and chronic source of antibiotic resistant bacteria and genes released into the environment. They also reflect the drug-use habits of the population in the antibiotics that persist in the effluent as it is discharged into receiving rivers. As such, significant innovation is required in wastewater treatment systems to mitigate these threats to the environment and human health. The challenge to the research community will be in providing the evidence base needed to justify appropriate wastewater engineering targets, while also considering the effects of chemical mixtures and the importance of co-selection (i.e., metals and biocides).²⁶

Healthcare is responsible for its supply chain – the production of the pharmaceuticals that treat patients. There are still gaps in our knowledge of environmental pharmaceutical contamination from manufacturing sites. There is evidence of high concentrations of pharmaceutical pollution linked to manufacturing sites in Europe, as well as examples in China, India and elsewhere in Asia.²⁷ Where the data exist, internationally there is evidence of sites with environmental concentrations thousands of times higher than seen from UK effluence, indeed similar to therapeutic concentrations.²⁸

Currently, the strongest evidence of human health impacts in England from pollution at these manufacturing sites, given the potential global spread antibiotic resistance genes, relates to antibacterial drug resistance (see Box 6). High concentrations in

the environment impact on antibacterial resistance.²⁹ These would notably be industrial sources and sites, but also farming, aquaculture and others. In terms of antimicrobial resistance, focus on these high concentration sites should not exclude other sources. Sources such as excretion, which have a large total load but spread through the environment, contribute – with a much greater total number of bacteria exposed.³⁰

The *Davos declaration* of 2016, an industry agreement to combat antimicrobial resistance, explicitly states a commitment to “reduce environmental pollution from antibiotics”, in order to reduce antimicrobial resistance.³¹ Both industry, in working to meet this declaration, and the NHS, through its procurement, have a role in reducing manufacturing pharmaceutical, including antimicrobial, pollution. Further information for users and transparency in the supply chain will be critical to allow consumers to make choices that reduce pharmaceutical pollution.

Box 5 Industry efforts to control PIE

Jason Snape, AstraZeneca Global Environment

Steve Brooks, Pfizer Inc

One of the consequences of delivering essential medicines to patients is that active pharmaceutical ingredients (APIs) can find their way into the environment. By far the greatest environmental load of pharmaceuticals is a result of patient use (excretion after therapeutic use or improper disposal). On a global scale, pharmaceutical manufacturing operations contribute a small part of the total environmental burden of pharmaceuticals. However, it is recognised that manufacturing discharges have the potential to result in 'hot spots' unless these are adequately assessed and controlled by manufacturers.ⁱ

Detection of trace levels (typically ng/l) of APIs in drinking waters has raised some concerns; however, the UK Drinking Water Inspectorate (DWI) and the World Health Organization (WHO) have both concluded that concentrations of pharmaceuticals found in drinking water are significantly lower than therapeutic doses and are unlikely to elicit a pharmacological effect (in the case of the WHOⁱⁱ) or pose an appreciable risk to human health (in the case of DWIⁱⁱⁱ). Additional published studies have also concluded that pharmaceutical exposure via drinking water is unlikely to pose a risk to humans.^{iv,v,vi} Research concerning relationships between environmental concentrations of antimicrobials (for example from agriculture, animal husbandry, manufacturing effluent, human use and excretion) and the development of antimicrobial resistance (AMR) continues to evolve and more work in this area is required.

The pharmaceutical industry recognises there are concerns about pharmaceuticals in the environment and is proactively engaged in efforts to better understand, and where appropriate, take steps to further reduce risk for example through its EcoPharmacoStewardship (EPS) initiative. Many pharmaceutical companies are members of the Industry AMR Alliance^{vii} and in September 2016, 13 leading pharmaceutical companies signed the AMR Roadmap to further commit to curb the development of antibiotic resistance.^{viii}

The AMR Roadmap includes commitments to reduce the environmental impact from the production of antibiotics and to develop and apply a common framework for managing antibiotic discharge across the supply chain by 2020. The AMR Roadmap companies are also committed to working with independent technical experts to establish science-driven, risk-based targets for discharge concentrations for antibiotics, by 2020. The AMR Industry Alliance issued its first progress report in January 2018 (<https://www.amrindustryalliance.org/progress-report/>).^{ix}

Additionally, the Pharmaceutical Supply Chain Initiative (PSCI; <https://pscinitiative.org/home>) actively educates industry suppliers on environmental management and the need to manage the specific environmental risks associated with APIs in manufacturing effluents.

References

- i Larsson, DGJ, 2014, "Pollution from drug manufacturing: review and perspectives", *Philosophical Transactions of the Royal Society B* 369: 20130571.
- ii World Health Organisation. 2012. *Pharmaceuticals in Drinking-water*. WHO Press. Geneva. Switzerland
- iii Boxall ABA, Monteiro SC, Fussell R, Williams RJ, Bruemer J, Greenwood R and Bersuder P. (2011). Targeted monitoring for human pharmaceuticals in vulnerable source and final waters. Drinking Water Inspectorate Project No. WD0805 (Ref DWI 70/2/231)
- iv de Jesus Gaffney et al. (2015). Occurrence of pharmaceuticals in a water supply system and related human health risk assessment. *Water research* 72, 199-208.
- v Houtman et al. (2014). Human health risk assessment of the mixture of pharmaceuticals in Dutch drinking water and its sources based on frequent monitoring data. *Science of the Total Environment* 496 (2014), 54–62.
- vi Oldenkamp, R. (2012). Spatially explicit prioritization of human antibiotics and antineoplastics in Europe. *Environment International*, 13-26.
- vii IFPMA AMR Alliance.
- viii AMR Roadmap Declaration.
- ix <https://www.amrindustryalliance.org/progress-report/>

Box 6 Environmental pollution is a driver of antibacterial drug resistance

*William H Gaze, European Centre for Environment and Human Health,
University of Exeter*

Andrew C Singer, NERC Centre for Ecology and Hydrology

Environmental pollution containing antibacterial resistant (ABR) bacteria, drug residues and other bioactive compounds is associated with the evolution and spread of ABR. Resistance evolves through mutation or by genetic exchange, mobilising clusters of 'linked' ABR genes between bacteria. Linkage of genes conferring resistance to antibacterials and co-selecting compounds such as biocides and metals means that ABR may evolve in the presence of a range of environmental pollutants, increasing ABR in the environment and the risk of transmission to humans. Conversely, environmental bacteria harbour diverse ABR genes that evolved to give protection to natural antibacterials produced by micro-organisms, and environmental pollution is likely to play a role in amplification and transfer of these genes to clinical pathogens.

Antibacterial drugs are excreted by humans and animals in an active form which enter the environment through waste water or application of sewage sludge and manure to farmland. Globally, more than half of antibacterial drugs are used in farm animal production. Therefore, most antibacterial drugs enter the environment as pollutants where they are usually present at considerably lower concentrations than are used to treat infections. However, the concentration of antibiotics in UK sewage effluent may be sufficient to select for some ABR genes.ⁱ The production of many antibacterial drugs occurs in India and China. Despite regulation to control pollution, concentrations of drugs downstream of manufacturing facilities can exceed UK river concentrations by 1,000-fold. This has been shown to exert a strong selection pressure for emergence of novel resistance mechanisms.ⁱⁱ

Concurrent with the risk of waste water and agricultural pollution driving selection for ABR is the risk posed by ABR bacteria. A considerable proportion of bacteria released into the environment are native to the gut of humans or animals treated with antibiotics. A study in the River Thames demonstrated that levels of ABR are predictable and associated with waste water and agricultural pollution.ⁱⁱⁱ The cocktail of resistant bacteria, antibacterial drugs, biocides and metals presents a significant risk of ABR spread and transmission to humans. It is known that novel ABR genes in Gram-negative pathogens such as those conferring resistance to 3rd generation cephalosporins (for example *bla*_{CTX-M}), carbapenems (for example *bla*_{NDM-1}) and colistin (eg. *mcr-1*) originated in environmental bacteria. A critical point to note is that evidence suggests the environment is the single largest source and reservoir of ABR.^{iv} Recent estimates suggest over six million exposure events occur in UK bathing waters each year resulting in ingestion of ABR *E. coli* and an association between bathing water exposure and gut colonisation by *bla*_{CTX-M} bearing *E. coli* has also been reported, although the number of resulting infections is unknown.^{v,vi}

Evidence of environmental transmission of ABR to humans is increasing, but it is currently not possible to determine the relative contribution environmental pollution plays in increasing ABR infections in the clinic. Mitigation strategies are available to reduce both ABR bacteria and drug residues in environmental waste streams^{vii}, however more evidence of the contribution of environmental pollution to clinical infection by ABR pathogens is necessary to inform decision making.

References

- i Gullberg, E., et al., MBio, 2014. 5(5).
- ii Larsson, D.G., C. de Pedro, and N. Paxeus, J Hazard Mater, 2007. 148(3): p. 751-5.
- iii Amos, G.C., et al., Isme J, 2015. 9(6): p. 1467-76.
- iv Surette M. and Wright, G.D. Annu Rev Microbiol. 2017 Jun 28. doi: 10.1146/annurev-micro-090816-093420. [Epub ahead of print].
- v Leonard, A.F., et al., Environ Int, 2015. 82: p. 92-100.
- vi Leonard, A. F., et al., Environ Int, 2018. S0160-4120(17)31234-5.
- vii Singer, A.C., et al., Front Microbiol, 2016. 7: p. 1728.

Author's suggestions for improvements

- Medical doctors and others in healthcare need training in order to increase awareness of environmental issues related to treatment strategies.
 - This could include environmentally better prescription choices, producing the same health benefit for the patient with the smallest pollution footprint (not simply substitute the type of pollution)
 - Information on the environmental characteristics of treatments must be made readily available to support this.
- The adequacy of packaging sizes to consumers' needs and doctor's prescriptions might be reconsidered and there could be a need for systematic reporting of internet and OTC sales.
- Major improvements in waste management could be focused on the improvement of collection schemes for unused human and veterinary medicines, as well as tracking their efficiency.
- More efforts are needed to improve and harmonise monitoring for pharmaceuticals in the environment.
- Engage industry and consider environmental standards in production and purchases globally. This should focus on industry transparency, as well as monitoring active pharmaceuticals in the supply chain, reductions in discharges, including economic incentives for less polluting manufacture.
- The research community should provide the evidence base in order to select appropriate wastewater engineering targets with respect to pharmaceuticals and underpin innovations wastewater treatment systems, including considering the effects of chemical mixtures and the importance of co-selection (i.e. metals and biocides).

A low harm and low waste, health and care system

Healthcare organisations create huge amounts of waste; in 2016/17 over 590,000 tonnes from NHS providers in England alone was created, which is more than the entire municipal waste from some European countries like Cyprus and Luxembourg.^{32,33} This waste is generated from office materials, clinical waste, food, drugs, and medical devices: all of which must be disposed of in careful (and costly) ways. The WHO estimates that 75-90% of waste from healthcare facilities is non-hazardous – akin to waste from other sites such as office or household waste.³⁴ The remaining 10-25% may be infectious or biohazardous, therefore needing specific disposal in order not to create harm.

All medical care involves some pollution. All unnecessary care, therefore, costs: in harm to the patient and the purse, and is unnecessarily polluting. Important categories of waste in healthcare include overtreatment, failures of care coordination, and failures in execution of care processes: these all impact on quality of care and cost.³⁵ Ensuring the incentives lie with the originator of any waste and pollution (akin to “polluter pays”) can be hugely beneficial for health.

All reduction of waste starts with procurement. Leaner procurement mechanisms such as “Just in time supply chains” and collaborative arrangements whereby the NHS buys the “service”, not the “product” can greatly reduce waste and thus associated pollution: this incentivises the provider (on whom the cost falls) to reduce waste and pollution. Environmentally preferable purchasing (EPP), the purchase of the least damaging products and services, and green procurement, purchasing with consideration of the amount and toxicity of waste also play an important role in waste – and pollution – reductions.³⁶ Healthcare plastics, particularly PVC (prevalent in single use medical items such as anaesthetic masks) gives off harmful chlorine gas when incinerated. A push to phase this out by manufactures, for healthcare providers to procure less harmful alternatives (green procurement) and polluter-pays incentives (plastic industry funded recycling schemes for PVC), will all contribute to reducing this harmful pollutant.

Box 7 RecoMed: helping hospitals to recycle PVC and save costs

Jane Gardner; Head of Consulting Services, Axion

NHS Provider spend more than £80 million on waste each year. Hospitals can play a key role in contributing to valuable savings by recycling waste materials, such as plastics. PVC is a widely-used plastic used in healthcare that can be readily recycled into new products. It is used to make 40% of medical devices, especially those used frequently in anaesthesia and critical care. A large proportion of PVC is used in anaesthetic facemasks, post-operative oxygen masks, fluid administration sets and associated tubing. The average UK hospital uses more than 12,000 oxygen masks per year and around eight million anaesthetics are administered each year. It is estimated that up to 2,250 tonnes of PVC could be recycled by collecting these items alone from 150 hospitals in the UK.

Set up in 2014, RecoMed is a unique UK-wide scheme that collects single-use waste PVC items used by healthy patients who have undergone elective surgery and sends these for recycling. Funded by VinylPlus, the European PVC industry sustainability programme, the scheme provides an alternative, sustainable disposal route for waste medical items made from high-quality medical grade PVC. Run by project partners Axion, a resource recovery specialist, and the British Plastics Federation (BPF), RecoMed supplies recycling containers, communication materials and collections to participating NHS and private hospitals.

RecoMed recycling bins are sited on wards next to non-infectious clinical waste bins. Clear instruction is given to staff on what items can be accepted. Daily collections are taken to a central waste hold from where the RecoMed team deliver them to specialist recyclers.

Pioneered by anaesthetists, the award-winning scheme is now active in ten hospitals where it is helping clinical teams to increase recycling and reduce waste costs in theatres. The scheme is already showing tangible results with a total of 3,573 kgs of waste high-grade PVC collected - equivalent to 119,100 masks. This has been recycled back into new goods, such as horticultural products.

RecoMed collects accurate data on the tonnage recycled to calculate carbon savings. Each tonne of recycled PVC will replace about one tonne of virgin PVC compound used in new products, thereby reducing their carbon impact. This data can be used by individual hospitals to demonstrate efforts to reduce their overall environmental impact, as well as their financial savings. Recycling is much cheaper for hospitals, given the cost of clinical waste disposal, which ranges from £350 to £600 per tonne.

There's huge potential for further development. RecoMed offers the healthcare sector a major opportunity to increase their recycling efforts, whilst achieving helpful savings on high specialist waste disposal costs. It could be expanded to include single-use medical devices made from other polymers.

Too much waste is caused by poor stock control, and ends up in landfill or being incinerated (which in turn generates carbon dioxide, nitrogen oxides, and particulate matter). It is a legal requirement for NHS trusts to consider the waste hierarchy and strive to move away from disposal and progress to energy recovery, recycling, reuse and ultimately reduction/elimination. Some trusts have been zero waste to landfill for a number of years, meaning all waste not required by law to be treated/incinerated (that is, hazardous clinical) is reused, recycled or sent for energy recovery. Dealing with waste in a less polluting way is important (for example replacing landfill with mixed dry recycling, energy to waste recovery), but absolute reduction in waste (starting with procurement) and circular approaches to resource management should be the priority.

Global economics now make it cheaper to manufacture single use items within healthcare rather than carefully assess where multi-use items re-sterilised would be equally safe, cheaper, and cause less pollution through landfill and/or incineration. Further, there can be a clinical inertia – or comfort – in using single use due the perceived benefits, but this can go beyond necessity. There is sometimes good evidence to invoke the precautionary principle and promote, if not require, the use of single use items (Prion disease outbreaks where the long term risk is initially unknown). When good research, however, establishes the true risk, then we should not perpetuate a culture of single use inappropriately and universally. From a health and pollution perspective, the adoption of every single use item should be considered, not the default. The overuse of disposable equipment has a downside, being disproportionately polluting. This may impact on human health, for example via plastic (or metal) incineration and landfill. That said, it must also be acknowledged that there can be an economic argument for switching to and maintaining single-use. This argument can be increasingly persuasive in areas as in times of resource constraint.

Box 8 Greenhouse gases (GHG) in healthcare and global climate change – lessons for other pollutants

Burning of fossil fuels causes much of the climate change happening today, and the health sector in this country is an important source of pollution in the form of greenhouse gases. In 2015, the total carbon footprint of England's health and care sector was 26.6 million tonnes of carbon dioxide equivalent (MtCO₂e). This accounts for well over a third of public sector emissions in England.

The pollution caused by greenhouse gas emissions is important to assess for three reasons:

- The health effects of carbon pollution pose the biggest strategic threat to health we face³⁷
- The emissions caused by any activity or any sector is quantifiable with the use of nationally and globally agreed standards
- The emissions allowable to keep within safe boundaries for human health are well understood through high quality science from the global scientific community under the auspices of the UNFCCC IPPC³⁸ and through a clear legal requirement in this country.³⁹

The footprint of the NHS in the country was first calculated in 2009 in the context of the 2008 Climate Change Act. It aspired to cover all three GHG emission scopes (1: All direct GHG emissions; 2: Indirect GHG emissions from consumption of energy used on site but generated elsewhere, and 3: Other indirect emissions that are a consequence of the operations of an NHS, but are not directly owned or controlled by the NHS). It revealed the very large proportion (60%) that could be attributed to what the NHS procured. Pharmaceuticals and medical devices formed 29% of the total footprint.⁴⁰ Consequently, the NHS set itself a level of ambition to reduce the entire footprint of the health care sector in line with the Climate Change Act. Another example of a co-benefit has subsequently emerged: the reduction in energy use has helped not only reduce air and carbon pollution, but it has also saved the NHS £80 million in 2016/17.

Laws such as the Climate Change Act (2008) establish scrutiny processes that can be applied to any sector including the health sector. The Climate Change Act, for instance, established the Climate Change Committee that ensures the government sets targets. This applies to GHG pollution, although other mechanisms at a national level address other forms of pollution: for example COMEAP (the Committee on the Medical Effects of Air Pollutants) provides independent advice to government on how air pollution impacts on health. Subsequent research and proposed actions to limit the effect of such pollution on health complements COMEAP's work.⁴¹

Author's suggestions for improvements

- Waste reduction, notably through efficient procurement, must be at the centre of all efforts to reduce pollution and harm caused by healthcare.
- NHS bodies should use incentives to comply with the waste hierarchy, such as built into waste-management/ recycling contracts.
- Healthcare waste-management operations at local, regional and national levels should be well organised and well planned.

Summary and conclusions

The data and case studies presented give a compelling case for the health system to reduce the harm associated with health care. Laws such as the Public Services (Social Value) Act (2012) mean the NHS is now under a legal obligation to consider the environmental harm (as well as the social and economic benefit) for which it is responsible. This ranges from its huge purchasing power on energy, food, pharmaceuticals, etc., to specific innovations that need to be spread rapidly (such as solar power assisted ambulances that need not idle their diesel engines⁴²).

The most effective intervention in reducing pollution and harm is to provide healthcare only when and where it is needed, meaning that preventing the preventable should be a fundamental principle of improving health: less (healthcare) really can lead to more (health). Thirdly, many of the interventions that improve health (reducing air pollution through more active travel, improving home insulation, reducing overuse of antibiotics) have multiple benefits, both for patients now but also for the public in years and generations to come.⁴³ The time is right to quantify, assess and incentivise cleaner, and greener, health and care for current and future generations.

References

- 1 <http://www.sduhealth.org.uk/HOTT>
- 2 <http://www.sduhealth.org.uk/policy-strategy/engagement-resources/fnancial-value-of-sustainable-development.aspx>
- 3 SDU Health Outcomes of Travel Tool,
<http://www.sduhealth.org.uk/delivery/measure/health-outcomes-travel-tool.aspx>
- 4 Glasziou P, Moynihan R, Richards T, Godlee F. Too much medicine; too little care. *BMJ* 2013; 347: f4247.
- 5 Protecting resources, promoting value: a doctor's guide to cutting waste in clinical care. Academy of Medical Royal Colleges 2014.
- 6 5 Year Forward View, NHS England. 2014/2017.
- 7 Protecting resources, promoting value: a doctor's guide to cutting waste in clinical care. Academy of Medical Royal Colleges 2014.
- 8 Naylor C. King's fund. What if the NHS were to go carbon neutral? 2016.
<https://www.kingsfund.org.uk/reports/thenhsif/what-if-carbon-neutral-nhs/>
(accessed 19 May 2017).
- 9 Buck D. Population health systems. Going beyond integrated care. King's Fund 2015
- 10 Curry N, Ham C. Clinical and service integration: The route to improved outcomes. King's Fund. 2010.
- 11 <http://www.sduhealth.org.uk/delivery/measure/health-outcomes-travel-tool.aspx>
- 12 <http://www.sduhealth.org.uk/policy-strategy/engagement-resources/nhs-carbon-reduction-strategy-2009.aspx>
- 13 2015 HSC footprint; Pharma 11%, MDI inhalers = 3%, anaesthetic gases = 5%.
- 14 Evaluation of the scale, causes and costs of waste medicines (2010).
- 15 WHO 2012, Pharmaceuticals in drinking water.
- 16 Review of socioeconomic impacts of pharmaceuticals in the water environment. Technical Report WT1544. DEFRA: February 2015.
- 17 Straub JO Sustainable Chemistry and Pharmacy3(2016)1–7.
- 18 DEFRA (2016) Review of socioeconomic impacts of pharmaceuticals in the water environment
- 19 *Philos Trans R Soc Lond B Biol Sci*, 2014. 369(1656).
- 20 Herrick, Devon M. "Unnecessary Regulations That Increase Prescription Drug Costs."National Center for Policy Analysis, The National Center for Policy Analysis , 7 Mar. 2013, www.ncpa.org/pub/st346.
- 21 Evaluation of the scale, causes and costs of waste medicines (2010).
- 22 http://www.abag.ca.gov/bayarea/dioxin/pilot_projs/MW_Background.pdf
- 23 Wu, M., Atchley, D., Greer, L., Janssen, S., Rosenberg, D., and Sass, J.Dosed Without Prescription: Preventing Pharmaceutical contamination of our Nation's Drinking Water. Natural Resources Defense Council. January 2010.
- 24 Straub, J.O., Sustainable Chemistry and Pharmacy 3(2016)1–7

- 25 Study on the environmental risks of medicinal products FINAL REPORT
Executive Agency for Health and Consumers 12 December 2013.
https://ec.europa.eu/health/sites/health/files/files/environment/study_environment.pdf
- 26 Singer, A.C., et al., *Front Microbiol*, 2016. 7: p. 1728).
- 27 *Philos Trans R Soc Lond B Biol Sci*, 2014. 369(1656).
- 28 *Philos Trans R Soc Lond B Biol Sci*, 2014. 369(1656).
- 29 *Philos Trans R Soc Lond B Biol Sci*, 2014. 369(1656).
- 30 [Ups J Med Sci. 2014 May; 119\(2\): 103–107.](#)
- 31 Declaration by the Pharmaceutical, Biotechnology and Diagnostics Industries on Combating Antimicrobial Resistance
- 32 <http://hefs.hscic.gov.uk/ReportFilter.asp> accessed December 2017
- 33 <http://ec.europa.eu/eurostat/web/environment/waste/database>
- 34 <http://www.who.int/mediacentre/factsheets/fs253/en/>
- 35 Berwick DM, Hackbarth AD. Eliminating waste in US health care. *JAMA*. 2012 Apr 11;307(14):1513-6.
- 36 Safe management of wastes from health-care activities (second edition) WHO 2014
- 37 Lancet Commission 2009. Costello A et al.
- 38 IPCC
- 39 Public Services (Climate Change Act) 2008.
- 40 2015 HSC footprint; Pharma 11%, MDI inhalers = 3%, Medical devices = 10%, anaesthetic gases = 5%
- 41 Royal College of Physicians. Every Breath We Take: the lifelong impact of air pollution. Working party report, 2016.
- 42 <https://www.sduhealth.org.uk/news/210/solar-powered-vehicles-added-to-south-central-ambulance-service/>
- 43 Pencheon, D. People and planet: from vicious cycle to virtuous circle. 31st May 2012. *BMJ* 2012;344:e3774 <http://www.bmj.com/content/344/bmj.e3774>

Chapter 03

21st century chemicals

Chapter lead

Timothy W Gant¹

Chapter authors

Professor Timothy W Gant¹, DR Helen E. Smith², Dr Emma L. Marczylo³, Dr Miriam N. Jacobs⁴, Dr Timothy H. Marczylo⁵, Dr Ovnair Sepai⁶ and Mr Andrew Tristem⁷

1 Head of the Department of Toxicology in the Centre for Radiation, Chemicals and Environmental Hazards, Public Health England; Visiting Professor (Health and Medical Sciences) of the University of Surrey.

2,3,4,5,6 Centre for Radiation, Chemical and Environmental Hazards, Public Health England

Key points

- There are tens of thousands of chemicals in use across many sectors with major use in consumer products, petrochemicals (fuels and lubricants) and polymer plastics. Speciality chemicals are a broad class including crop protection products. All have the potential to pollute either through deliberate release or from inadequate waste disposal. Some chemicals are in fact highly complex and variable mixtures.
- Humans can therefore be exposed to a complex mixture of chemicals via various routes and from a variety of sources.
- New technologies, particularly DNA sequencing and analytical technologies for nucleic acids, proteins and metabolites are providing new genetic and physiological understanding that may necessitate re-visiting old chemical pollutants and their risk assessments.
- There will be a much greater need to take into account genetic and physical susceptibilities to specific chemicals in their risk assessment.
- Mixtures and complex chemical combinations are providing new challenges for risk assessment.
- There is a need to consider the health effects of biological materials from natural and manmade sources.

Overview

The use of synthetic chemicals in society can be traced back to the start of the industrial revolution in the 1700's. Prior to this time natural chemicals and elements, for example metals were used but the industrial revolution saw the first manufacture and use of synthetic chemicals in bulk quantities. The manufacture of sodium carbonate by the LeBlanc process (dating to 1791) provides our first report of chemically mediated environmental damage and litigation due to the discharge of hydrochloric acid from the process. Compared to then, the obvious, but notable change is the vast number of chemicals now on the market. Currently 145,297 chemicals (including duplicates) are pre-registered under REACH^{xi}, whilst globally, production of chemicals has increased from one million tonnes in 1930 to several hundreds of million tonnes today.

Chemical manufacture has provided many benefits to society, for example increased food production, hygiene improvements, drugs, new materials and electronics manufacturing. However there have also been adverse consequences from these chemicals contaminating the environment causing harm to both wildlife and humans. Consequentially there is generally a risk/benefit ratio that needs to be calculated for chemical use. This is not a static ratio, calculated once and never revisited. As new understanding, often resulting from new technologies (often resulting from new technologies themselves dependent on new chemicals) increase our understanding of risk then this risk/benefit ratio will need to be revisited. Furthermore, new alternatives may provide the benefit with reduced risk, or conversely may even provide an equal or greater risk to the chemicals they have replaced.

This chapter explores some of the chemicals for which we still have concerns in the 21st century.^{xii} Many of these are not new. The prodigious advances in our scientific understanding, particularly since the elucidation of the structure of DNA in 1952 and establishment of molecular biology, together with the parallel revolution in instrumentation and computing, have, led to an ability to recognise a much wider range of hazard types associated with chemicals and susceptibilities resulting from a variety of physical and genetic factors. Similarly advances in analytical chemistry, and associated technologies, have reduced the limits of detection and means that we can detect chemicals in environmental samples and humans at lower and lower concentrations leading to a revolution in understanding of human exposure to chemicals. Many of these methods generate so-called 'Big Data' that is the focus of Chapter 8, 'Pollution - data, surveillance and health impacts'. In totality these

^{xi} <https://echa.europa.eu/information-on-chemicals/pre-registered-substances>

^{xii} Chemicals in the context of this chapter will be taken to include all molecules regardless of use, products thereof, and include natural chemicals.

methods and data have led to an appreciation of the potential risks associated with chemical use but also challenges in terms of correctly interpreting the available data.

Box 1 The precautionary principle

The precautionary principle states that “When an activity raises threats of harm to human health or the environment, precautionary measures should be taken even if some cause and effect relationships are not fully established scientifically.”*

While laudable this can raise issues as scientific understanding of the interaction of chemicals with biological systems is further and more rapidly understood. In particular

- a) if new understanding causes existing chemicals to be withdrawn on a precautionary basis are the alternatives used any better?, and
- b) as new biochemical cause and effect relationships are understood there is a need particularly to understand if these relationships are causal in respect of disease and of sufficient concern to justify precautionary action.

* Tickner, J.A. and C. Raffenberger, The precautionary principle: A framework for sustainable business decision-making. *Corporate Environmental Strategy*, 1998. 5(4): p. 75-82.

Epidemiology and health outcomes

Epidemiology has played a crucial role in the identification of human harm. For example, epidemiology was essential in identifying the phocomelia^{xiii} (a condition in which the limbs are underdeveloped or absent) caused by thalidomide and mesothelioma caused by asbestos fibres. The association of the exposures in this case with the adverse outcome was strong enough to allow intervention long before causality was proven.^{1,2} For both of these examples, and others such as lung cancer and smoking, there are some critical factors that allowed epidemiology to be effective. The exposure was easily determined and the adverse outcome was unusual so epidemiology could come to a proven association between the exposure and outcome that was sufficient to justify intervention. For thalidomide there was the additional advantage that only a year was required to assess if the intervention of removing the exposure was successful as phocomelia occurs during, and is observed, at birth, whereas other adverse outcomes, such as some cancers have long latency periods making it difficult to assess the effectiveness of interventions.

Epidemiology in the 21st century is more complex. For many environmental exposures, including '21st century chemicals', associations can be much more difficult to derive for two major reasons. The exposure can be difficult to measure, particularly if at low level concentrations or a chemical combination. Secondly, the adverse outcomes often have a high background level in the general population making the determination of an increase in events difficult to distinguish. An example would be reported headaches and dizziness from low level or intermittent fume exposure. An increase in dizziness and headache is difficult to quantify against the high background, and difficult to associate with an exposure, making epidemiological association of cause and outcome challenging. These factors provide a critical challenge to epidemiology that can often only be resolved by larger studies to gain statistical power that then become increasingly expensive. Epidemiology, though, is benefitting from the data now available from electronic systems such as internet, satellite imaging and mapping and personal devices. Ultimately this will benefit the development of epidemiology to inform on human risk.

This is an important factor in looking at how we go ahead in the 21st century and dictates that epidemiology alone will not be sufficient. We are going to need more experimental studies where confounding variables can be separated. These experimental studies are going to need to focus more on real world exposures rather than doses high enough to get an effect, and be carefully designed to ensure as far as possible the data are translatable back to humans. This is also going to need to be achieved against a background of reduced animal use and needs to take into account human diversity.

^{xiii} A condition in which the limbs are underdeveloped or absent.

Burden of disease from pollutants

A Lancet Commission has recently examined the burden of disease from pollutants in detail. Worldwide premature deaths due to pollution were estimated to be nine million worldwide in 2015 (16% of the total) with the majority of this burden falling on low to upper middle income countries. A common factor across all countries, however, is that the majority of the burden is due to air pollution.³ This seems unlikely to change during the 21st century as air is arguably the most difficult to control of all the exposure routes. However while tackling air pollution, it is important not to forget the burden of disease due to land, food and water chemical exposures. Such exposures, although more prevalent in lower to middle income countries, still contribute to the overall burden in high income countries. Furthermore the nature of exposure is changing. Experimental methods to recognise acute hazards are well developed and so is risk management/prevention of acute exposure. For the 21st century the emphasis is going to be on the long term low level exposure that are both more difficult to assess (often requiring long extrapolations from acute exposure effects) and more challenging to manage.

Chemical regulation in the 21st century

Chemical legislation ensures a uniform approach to controlling the risks associated with the use of chemicals across a given product sector and geographical area. In the European Union the primary legislation for regulating chemicals is 'Registration, Evaluation, Authorisation & restriction of Chemicals Regulation' (REACH) (EU No 1907/2006) and 'Classification Labelling and Packaging Regulation' (CLP) ((EC) No 1272/2008), which outline a common set of rules across the EU that govern how chemicals are classified, labelled and packaged. Equivalents exist globally such as the Toxic Substances Control Act in the US, whilst equivalents exist globally. The EU has some additional regulations; the Plant Protection Product Regulation (EU No 1107/2009), the Biocidal Product Regulation (EU No 528/2012), the Water Framework Directive (2000/60/EC) and the Cosmetics Regulation (2009/1223/EC).

These pieces of regulatory legislation require agencies to oversee them, for example the REACH, CLP and Biocidal Products Regulations are overseen by the European Chemicals Agency (ECHA) and in the US the Environmental Protection Agency (EPA). Testing uses specific protocols, often agreed globally by the Organisation for Economic Cooperation and Development (OECD), but the protocols generally only apply to data generation, not to interpretation. Although guidance for interpretation is available, it can differ between agencies and countries. Data can be reviewed and interpreted by different, independent agencies that can lead to differing opinions, as has been seen recently with the evaluation of glyphosate by IARC and EFSA. Though the opinions of all agencies are valid, they are often different because they are based on different criteria; for example active substance versus formulation. These differences can be somewhat opaque and can lead to public confusion.

Box 2 REACH regulation

The REACH Regulation entered into force on 1st June 2007 and is designed to ensure a high level of protection for human health and the environment from chemicals, as well as the free circulation of chemicals in the EU market enhancing competitiveness and innovation. Crucially REACH shifted the responsibility to manage chemical risks from public authorities to industry.

REACH implementation requires data, which are usually derived from companies testing their chemicals (with additional data from academic sources). Testing uses specific protocols, often agreed globally by the OECD, but the protocols generally only apply to data generation, not to interpretation. Although guidance for interpretation is available, it can differ between agencies and countries. OECD tests can be used to determine a chemical's hazard by comparing the available data on a chemical to the standardised criteria for classification and labelling outlined in the United Nations Globally Harmonised System of classification and labelling of chemicals (GHS), which is implemented in the EU via the Classification Labelling and Packaging Regulation (CLP). Currently the REACH regulation requires that substances manufactured or imported within the EU at a quantity of one tonne per annum or more are registered.

For chemicals where it is deemed that their use poses an unacceptable risk to human health or the environment, risk management measures may be implemented and placed on a list of substances of very high concern. This may be followed by restriction or authorised use classifications. Before a chemical is subject to restriction or authorisation under the REACH regulation, the risks of the chemical, its alternatives and the socioeconomic impacts of that regulatory action are considered.

‘

‘21st century chemicals’ and new science

Understanding the impact of chemicals on health in the 21st century requires an appreciation of the advances in science over the last century, especially the last 50 years. Genomic methods and genetic biology in particular have had a substantial impact. It is now possible for the whole genomes of individuals to be sequenced quickly and at relatively low cost, giving rise to the very real possibility that each of us will have our personal genome as part of our medical records within the foreseeable future. The same technology means that many thousands of endpoints can be assessed for a chemical. Consequentially we can now measure chemical effects on biological systems before the development of recognisable physical outcomes. This raises the question how such effects relate to, and predict, adverse health outcomes.

Other molecular biology advances include high throughput screening, quantitative structure–activity relationship models. These approaches to testing and assessment are all advancing our ability to conduct hazard assessment more rapidly but translating this knowledge to and actual assessment of risk is becoming more challenging. The challenge, though, of managing hundreds of thousands of chemicals on the market will not be achieved without high throughput methods and grouping approaches.

Figure 3.1 Association of biological changes and apical outcomes

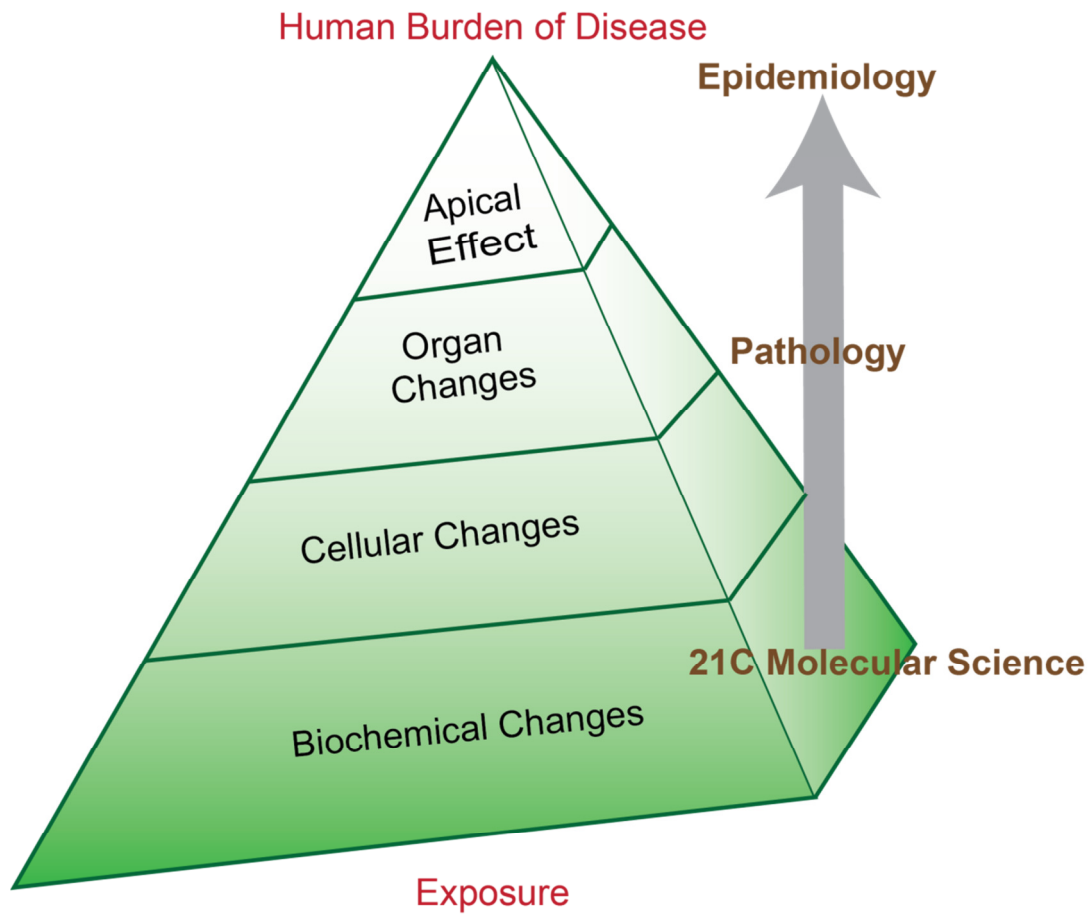

Source Professor Timothy W. Gant, Public Health England

New interactions or susceptibilities can be identified and thus 'old' chemicals have to be reconsidered in terms of their potential toxicology. Chemicals can only be regarded as no longer relevant to health when there is no longer any exposure – that is when they are removed entirely from the environment. There are therefore some chemicals that are both legacy chemicals but are still a 21st century concern due to the impact of new technologies recognising new interactions and potential toxicities. One such example is diesel particles, which act through newly identified mechanisms in immune cells, contributing to asthma development and exacerbation.

Allied with the development of new technologies has been the development of new biomarkers. These give greater insight into alterations in biochemistry and physiology, and therefore to changes that may occur due to chemical exposures that may not have been previously detected. Biomarkers are further discussed in Chapter 8, 'Pollution - data, surveillance and health impacts'.

Mixtures and chemical combinations

Historically chemical hazard evaluation tended to be considered in terms of individual chemicals but exposure to individual chemicals is not strictly representative of the real world scenario. We are exposed throughout our lives to complex mixtures of chemicals from a variety of sources on a daily basis and these mixture exposures can change both temporally and spatially. Furthermore chemicals are often used in mixtures, and many chemical products are mixtures in their own right. The challenge: to assess health risk from chronic, lifelong exposure to complex chemical combinations is difficult. It requires the nature of the composition to be taken into account but also the interaction of those chemicals. Further interactions with the wider environment and lifestyle need to be taken into account. These complexities are often poorly understood, resulting in a default of adding up the hazard potential of individual chemicals – which may be an underestimate if effects are in fact synergistic.

This issue becomes particularly acute when considering chemicals that fall into the class of unknown or variable composition, complex reaction products or biological materials (UVCB). The composition of these substances cannot be easily identified for various reasons, including having too many chemicals within them or showing variance in composition (between batches). Though it might be considered that these are rare, in fact the opposite is the case. Most refined oil products fall into this class, as do substances such as natural oils and perfumes. As of January 2017, 21% of substances registered under REACH were Chemical Substances of Unknown or Variable Composition (UVCBs).⁴ There is a need for better methods to assess the hazard of these UVCB mixtures and put them into groups. One such UVCB grouping project using oil products as an exemplar is Cat-App.^{xiv}

^{xiv} <https://www.concawe.eu/mediaroom/cat-app-project/>

21st century pollutants

The next sections address some of the classes of chemicals often found in the environment that could continue to be a source of concern into the 21st century, even as in some cases their environmental concentration, or use, declines. In some cases compounds are subject to restrictions and authorisations but this can then drive replacement by alternatives that may be less adequately tested – this can lead to ‘regrettable substitution’ where a chemical with a greater hazard is substituted for one with a lesser hazard.

Dioxins and polychlorinated biphenyls

Dioxins and polychlorinated biphenyls (PCB’s) are a large category of chemicals. Exposure was first noted in the 1940s with experimental demonstrations of toxicity in the 1970s. One example, 2,3,7,8-tetrachlorodibenzodioxin (TCDD) is classified as a Group 1 carcinogen by IARC. Studies following up past exposure, such as from the Seveso industrial accident or after exposure to herbicide agent orange have identified possible birth defects in the exposed populations at high doses,^{5,6} with studies continuing to assess long term impacts. The major observable toxicity in acutely exposed humans is chloracne.⁷

Dioxins and PCBs fall within a class of chemicals listed as persistent because they do not degrade in the environment. They also have little solubility in water, therefore tend to accumulate in fat sources and concentrate up the food chain. Though historically more than 90% of exposure has been through the food chain⁸ this has been falling in recent years. Their metabolism and excretion from the body is also slowly adding to their ability to accumulate in humans, animals and fish. Estimates from food samples collected in the US in 1995 showed that freshwater fish had the highest concentration, with fruits and legumes containing the lowest concentrations.⁹ The UK Committee on Toxicity of Chemicals in Food, Consumer Products and the Environment (COT) has more recently reviewed exposures from food and found that the levels are greatest from oily fish and some meats such as deer. Importantly, exposure has been declining since 1980 and continues to do so.¹⁰ The current estimate for exposure is for 70% of the tolerable daily intake (TDI) and therefore though a current concern decreased use does not indicate a need for continued vigilance.¹¹

Since the 1980's dioxins have been known to elicit many of their toxicological effects via binding to a specific intracellular protein, the aryl hydrocarbon receptor (AHR).¹²⁻¹⁵ What had not been known until recently is that this mechanism is important in the activation of immune system cells and is a link to autoimmune diseases (see Figure 3.2).¹⁶ There may therefore be a link between exposure to these chemicals in the environment and the substantial rise that has been observed in autoimmune diseases over the last decade.¹⁷ Evidence has recently been published in respect of a mechanistic link between diesel particles from transport and immune cell activation that could partially explain the increases in asthma incidence that affect 1:12 adults and 1:11 children in the UK.¹⁸

Figure 3.2 Role of the AHR receptor and activation by environmental pollutants in autoimmune and allergic immune diseases

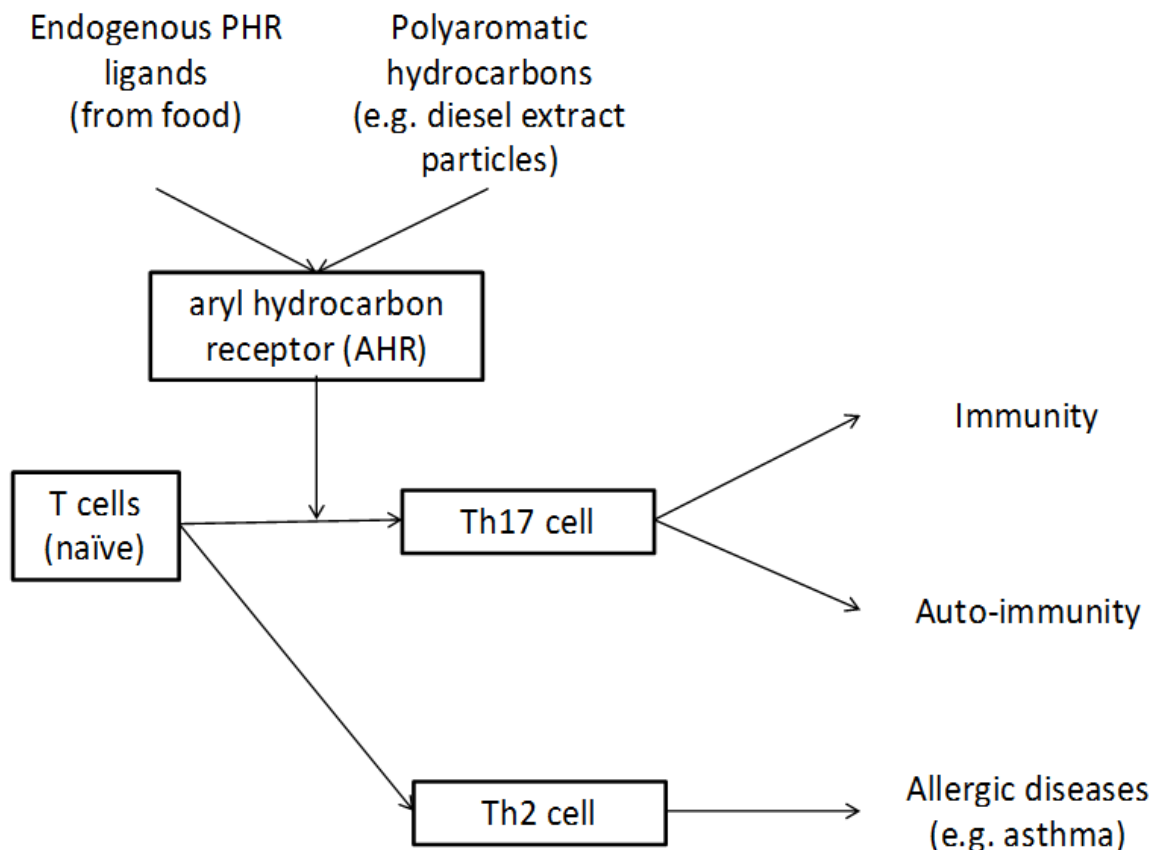

Source Professor Timothy W. Gant

Polycyclicaromatic hydrocarbons (PAHs)

Polycyclicaromatic hydrocarbons (PAHs) are a large group of carcinogenic chemicals formed as byproducts of combustion and widely distributed in the environment. PAHs are found in both air resulting from vehicle exhaust particulate matter¹⁹ and in soil, typically in old industrial sites or heavily populated areas.^{20,21} Additionally, PAHs result from wood and biomass burning.²²⁻²⁴ Emissions overall have been declining in the UK since 1990 particularly from commercial and agricultural sources, the latter probably reflecting the much decreased use of biomass burning.¹⁹ However, despite an overall decrease in PAH levels since 1990, they have been increasing again between 1995 and 2010. This is probably due to the increasing use of wood burning stoves.²⁵ Nevertheless monitoring stations across the UK still indicate the PAHs in the atmosphere are much less than the 1 ng/m³; the European commission target value.

Many, but not all, PAHs are carcinogens and classified by the IARC as class 1 (carcinogenic to humans). Carcinogenicity of certain PAHs has been well studied in laboratory animals, with observed increased incidence of skin, lung, bladder, liver and stomach cancer. Therefore increases in the environment would be of concern and there are some indications of health effects associated with wood burning that could be due to PAHs such as inflammatory responses,²⁶ vascular dysfunction²⁷ and breast cancer.²⁸ In addition to cancer effects recent discoveries in basic science have thrown new light on the relationships between asthma and air pollution mediated through the AHR receptor (Figure 3.2).²⁹

Box 3 **Indoor air pollution**

*Professor Alastair Lewis, National Centre for Atmospheric Science,
University of York*

Air pollution found inside homes and the workplace makes an important contribution to an individual's overall exposure to any given pollutant. Indoor air pollution can be affected by outdoor concentrations, with air pollutants exchanged readily where buildings have poor insulation and high ventilation rates. In the UK, outdoor air quality has improved over the past 40 years and buildings have become more energy efficient, with low rates of air exchange. A consequence has been that indoor air pollution is increasingly decoupled from air quality outdoors; it is now affected predominately by emissions and activities occurring within buildings themselves.

The chemical and biological classes of air pollutants found indoors are broadly similar to those found outside, with similar underlying biological mechanisms for impacting on human health. There are however differences in the *relative* distribution of pollutants and chemicals. Most of the key outdoor air pollutants are found indoors, including particulate matter (PM_{2.5} and PM₁₀), NO₂, CO, and a range of volatile organic compounds (VOCs). Ozone is not found in substantial concentrations indoors since as a reactive species it is readily destroyed on indoor surfaces. Few UK homes burn high sulphur-content coal and a consequence is that SO₂ is also not found in large amounts indoors.

The key sources of indoor air pollution are related to combustion-related processes and emissions associated with the consumption of manufactured chemical products. Combustion sources in the home release a broad range of pollutants (as they do outside) including PM, NO_x, CO and VOCs. The largest indoor combustion sources are from central heating (as a primary heat source), cooking (including direct combustion and oils/fats released as aerosols) and discretionary activities including decorative use of open fires, solid fuel stoves and candles.

Indoor air pollutants deviate most substantially from outdoors in the relative amounts of VOCs. Outside, VOCs are now found at typically very low concentrations, rarely above limit values set in air quality legislation. Indoors, VOCs can be found at substantially higher concentrations reflecting the wide range of products that emit this class of pollutant. Well-established sources of VOCs include building materials (wood treatment, carpets, paints, flooring and so on) and furniture; both sectors are subject to product regulation that aims to minimise indoor emissions. In addition a wide range of other consumer products also release VOCs indoors, including adhesives and inks (where the VOC is a solvent), pesticides and volatile fragrance contained in cleaning and personal care products.

Most VOCs are considered to be of low toxicity, however long-term impacts on health are uncertain. Further, there is evidence that the trend for increased building energy efficiency and increased public consumption can result in elevated concentrations indoors. A chemical of specific health interest indoors is formaldehyde. Outdoors formaldehyde, typically at low concentrations, is rarely considered in the context of direct harm to health. Indoors formaldehyde can be ten to 100 times higher in concentration, a result of direct emissions and from secondary production where formaldehyde is formed as other VOCs oxidized in air. Formaldehyde has a wide range of reported health impacts including as an eye and lung irritant, and it carries longer-term cancer risk.

There are some notable differences in how individuals can manage exposure to indoor air pollution that differ to outdoors. Outdoor air pollution is not the consequence of the actions of any single individual. Concentrations in the home are largely a consequence of a series of specific occupant actions coupled to the building air exchange rate, both factors over which individuals have a substantial degree of autonomy and control. In most locations (away from busy roads), outdoors air is likely cleaner than indoors for the majority of classes of air pollution. In such circumstances reducing the indoor emissions of pollutants, for example by changing patterns of discretionary combustion and chemical consumption, may lead to direct reductions in exposure, as can actions that increase ventilation through simple actions such as opening windows more frequently.

A barrier to supporting more direct individual action is a lack of a reliable low-cost measure of indoor pollution to support decision-making and a limited awareness of how personal actions impact on indoor air quality. More broadly variability in indoor air quality is a major confounding factor in the interpretation of epidemiological data on outdoor air pollution effects, since indoor exposure cannot be easily predicted based on simple factors such as age, postcode, and income.

Microplastics

The world economy generated about 299 million tonnes of plastic in 2013.³⁰ Approximately 2-5% of this is estimated to have ended up in the ocean, much in the form of discarded plastic packaging.³¹ Thus, between five and twelve million tonnes of plastic waste was discarded directly into the environment, much of it non-biodegradable. Over time this will break down to form microplastics that are found in deep sea creatures, indicating just how pervasive these 21st century pollutants have become.^{32,33}

Microplastics are small plastic particles, less than 5mm in diameter, that arise in the environment from the degradation of discarded plastics (secondary microplastics) or are manufactured (primary microplastics) – including cosmetics^{xv} and products, such as those used in oil drilling and as abrasives. Other sources of these particles (and fibres) are vehicle tyres, road paint and clothing.³³ As these particles are now extensively found in the environment there are concerns about their transfer into food chains and into the air. For this reason the major exposure routes of concern in respect of human exposure are ingestion from food and inhalation. Consequentially there are three main concerns:

- a) physical toxicity such as blockage of the gut,
- b) chemical toxicity arising from chemicals released from the particles that could be plastic monomers, colourings and plasticisers and;
- c) lung damage such as inflammation and secondary fibrosis.

The human exposure, hazard and therefore consequences of exposure to these microplastics are largely unquantified. The plastics themselves will be of different types and so the identity and quantity of the chemicals involved could be challenging to assess: as is the degree to which component chemicals of the plastics will be released into the environment.

The consequence, even the extent, of exposure in humans is unknown. Exposure to microplastics through food is possible, based on studies of seafood; however, it is unknown if this translates into meaningful exposure in the population.³⁴ There is an absence of toxicological data that has meant that effective risk assessment is not possible. It is possible that lipid soluble phthalates and other chemicals from the plastics could be absorbed from microplastic ingestion, as they are lipid soluble. Humans, however, are already almost universally exposed to these chemicals as a result of their use in plastic products. Phthalates used in plastic are

^{xv} There are now extensive voluntary bans in place on the use of these particles in consumer products because of the concerns about the subsequent transfer of the particles to the environment.

currently considered to have a low hazard despite some concerns in respect of their potential ability to interact with hormonal systems.³⁵

Nevertheless, the burden in the environment should not be further increased.³⁵ Microplastics can potentially act as vectors for, and enhance the transport of, other organic materials.³⁶ They can also break down to very small sizes which can be translocated from the gut³⁷ and in some cases across the placenta.³⁸ In marine organisms blockage of the intestinal tract can occur, although this is unlikely to occur in humans due to the larger size of the intestine. There is also a theoretical possibility for physical toxicity from accumulation in organs such as the kidneys. Thus more work on the potential for human health effects is required.

Recently cosmetics manufacturers have voluntarily reduced or eliminated plastic micro-particles as exfoliants because of concerns over their release into the environment. However microbeads are only a small part of the overall problem. A substantial amount of plastic waste still enters the environment from land and at sea and will contribute to the problem of microplastics in the environment for a long period even if further environmental contamination does not occur.

Endocrine-disrupting chemicals (EDCs)

Endocrine-disrupting chemicals (EDCs) are substances that alter the functions of the hormonal system and consequently can cause adverse effects for human health.³⁹ As public concern has increased and NGOs have taken an active interest, intergovernmental initiatives have been introduced to better screen and regulate such chemicals, and thus improve environmental and public health protection.

Public concern started to grow in the 1960s⁴⁰ following observations of reproductive failure in wildlife species, especially birds.⁴¹ The term 'endocrine disruptor (ED)' was adopted to describe these chemicals.⁴² A widely used definition is '*an exogenous substance or mixture that possesses properties that might be expected to lead to endocrine disruption in an intact organism, or its progeny, or (sub)populations*'^{xvi} and scientific criteria for the identification of EDCs have been published.⁴³

A body of literature now documents an increasing incidence of breast cancer in women⁴⁴, decreased sperm counts and increasing incidence of testicular cancer in men⁴⁵ and other endocrine disorders increasing in the human population. As all of these cancers have a hormonal component association has been made with EDCs as a means of explaining the increase in incidence. In humans there are examples of such toxicity with potent pharmaceutical agents, for example diethylstilbestrol but association of most environmental pollutant EDCs with human disease is not proven and therefore contentious. There could be other physiological and lifestyle factors that could account for, or contribute to, the increases in hormonal cancers observed.

EDCs will remain chemicals of concern for the 21st century and while the hazard characteristics of some EDCs have been established, the risk to human health has not. The focus therefore needs to be on establishing actual risk. Given the complexity of the endocrine systems and health end points this is a substantial task.

To address the issues some international endocrine relevant chemical screening programmes have been created, and in 1998 the intergovernmental OECD work programme on Endocrine Disruptor Testing and Assessment was initiated. The first ED tests to be developed have focused on the oestrogen, androgen, thyroid, and steroidogenesis pathways. However, the array of modes and mechanisms of action that require test method development are expanding to a) include other related endocrine pathways,⁴⁶ and b) specifically to address mechanisms/modes of action, with respect to temporal considerations through life and for subsequent generations.^{47,48} The need for the development of further test methods therefore remains.

^{xvi} WHO International Programme on Chemical Safety (2011)

Bisphenol A and phthalates

Bisphenols and phthalates are important in the production of plastics of various types and exposure is almost universal. Some of these chemicals, in particular Bisphenol A, have given rise to other products with different uses. For example tetra-bromo-Bisphenol A, which is used as a flame retardant particularly in electronics. Some chemicals in these classes have given rise to concern for two reasons; a) they have a well-defined hazard, interacting with endocrine targets, and b) because of the almost universal exposure primarily often from food.

Defined hazards have, however, given rise to a great deal of misunderstanding amongst both the public and professions. Furthermore increases in endocrine associated tumour types have led many to make an assumption that there is a causal relationship between these endocrine acting chemicals and the rises in specific tumours such as breast and testicular. Making these associations can lead to misunderstanding. For example although Bisphenol A, a chemical with a known and defined ability to activate the oestrogen receptor it is metabolised rapidly in humans to a non-active metabolite and rapidly excreted, resulting in a low internal exposure. This means that, though there is a well-defined hazard, potential exposure at the relevant internal organs is low to negligible thereby substantially mitigating risk. Phthalates, identified as category 2 reproductive toxicants, have been banned from use in general consumer products, including toys and cosmetics.

This indicates a challenge that we need to face in the 21st century – to regulate chemical use on the basis of risk rather than hazard. There is no doubt that Bisphenol A and many other chemicals pose a particular hazard at certain concentrations. For Bisphenol A though the risk – a product of hazard, exposure and vulnerability – is largely discharged on the basis of relevant internal exposure. Though the battery of tests for assessing hazard are incomplete hazard testing is arguably more advanced than the understanding of risk, and for this reason regulation is often based on hazard. Where more understanding is required is at the level of exposure and mode of action pathways. With more understanding of these facets of the toxicological pathway then regulation could move towards the level of risk and also address vulnerabilities. Overall this would be a more satisfactory approach, driving innovation and leading to the use of more sustainable chemicals with decreasing hazard profiles. Such testing would lead to a) a more appropriate regulatory framework and b) reduced use of alternative chemicals as replacements for which there is often less available safety, and a lower level of risk understanding than for the chemical they replace. For example, Bisphenol A has often been replaced by the structurally similar Bisphenol S, about which less is known in respect of its hazard or risk.

Perfluorinated chemicals

Perfluorinated chemicals (PFCs) have been manufactured for approximately the last 50 years and are used in a wide variety of products on account of their hydrophobic, non-combustible properties and resistance to degradation. The latter means that in the environment some such as the long chain (eight carbons or more) are persistent and bioaccumulative, and can be transported to environments distant from their source.⁴⁹ Some, such as the perfluorinated acids are water soluble and can undergo aqueous transport over long periods of time.⁵⁰ One PFC (perfluorooctane sulfonic acid - PFOS) is listed in the Stockholm Convention on Persistent Organic Pollutants (2009), meaning its use is restricted whilst others are being considered. They are used in a wide range of industrial and household products. PFCs are found in varying concentrations in many aquatic environments⁵¹ and, the serum and breast milk of many who live in industrialised countries though levels may have peaked in the last decade of the 20th century.⁵²

Positive associations with health outcomes in human epidemiological studies are increases in serum levels of cholesterol and uric acid, possibly due to competition in the kidney for transporter proteins.⁵³ The outcome of increased cholesterol might be anticipated to be cardiovascular disease but this has not been observed in epidemiological studies. In high dose animal models a variety of health outcomes are reported including immune responses,⁵⁴ thyroid hormone effects⁵⁵ and liver toxicity.⁵⁶ Thyroid hormone effects have been a particular concern for the developing foetus. Here, the hormone is vital for neurological development and because some PFCs can compete for thyroxin on the thyroid hormone transport protein this could potentially limit delivery to the fetus.⁵⁵ Some neurotoxicant behaviour has have been modelled in the mouse⁵⁷ though the relevance for this at human exposure levels is not clear.

Other effects are seen in the liver including peroxisome proliferation, a biological effect known not to be relevant for human liver disease.⁵⁸ All of these effects occur at exposure levels several orders of magnitude above those generally observed for human exposure. In exposed worker studies some associations of perfluorinatedoctanoic acid (PFOA) with diabetes mortality have been observed.⁵⁹ Currently PFCs appear not to be anywhere near exposure levels for the majority of the population that could lead to health outcomes, and there is still debate regarding the toxicity of PFCs on human health in the general population. However, as they continue to be manufactured and released into the environment, and persist for a long time in the environment and the human body, there is a need to maintain vigilance for health outcomes. Monitoring is particularly important around sites where these are used intensely, such as the international examples near airfields and military sites where large volumes of firefighting foam are used. Further, there clearly is a need for more mechanistic evidence that would direct the epidemiology in terms of health outcomes as well as adding causative weight to the findings of such studies.

Metals

Metals of all types constitute an interesting challenge for 21st century. For some of the recognised more toxic metals, such as lead, controls brought in to reduce emissions including the removal of lead additives from vehicle fuel have led to dramatic reductions since the turn of the century. The same is true for mercury. Resulting from restrictions put in place following the recognition of the role of mercury in causing Minimata disease have reduced emissions from the industrial sector. In contrast the transport sector has been contributing to an increase in various types of metal exposure. Traffic associated metals from transport take the form of particles. These particles come, not from the combustion of fuel, but from brake wear which means it is applicable to all types of vehicles no matter what the fuel type or if they are running on roads or rails. Common amongst the increasing particulate metal exposures are arsenic, iron, tin, copper, nickel and vanadium. All of these metals can elicit toxic effects in sufficient dose. Further, in the particle sizes in which they are released from brakes they have the capability to penetrate deep into the lung where they can be absorbed into the systemic circulation.

Although environmental lead concentrations have been decreasing, a legacy lead contamination remains particularly in brownfield land development sites. This risk is managed by measurement and risk assessment when these sites are developed. Such measures should sufficiently manage any residual risk. However there are still debates about whether the current limit levels are sufficiently protective. These debates will continue as science develops and in particular as the use of genomics and allied technologies lead to an improved understanding of hazard and vulnerability. There will remain a continuous need to revisit such legacy metals.

There are many more metals that have an associated hazard potential. As these metals are used in new applications, such as batteries, there is a need to ensure that efficient collection and recycling processes are in place to prevent their release into the environment. Many toxicological hazards can be effectively managed through correct use and disposal methods that substantially reduce or eliminate contamination and exposure. It is when these risk management standards are not properly implemented or enforced that environmental contamination can occur leading to human exposure and risk. This just a role for governments and its departments; all chemical users have a role to play.

Flame retardants

Flame retardants (FR) are a family of chemicals incorporated into a diverse selection of consumer products including clothes and other fabrics, electronic goods, furniture, flooring and in building materials to prevent them igniting. There are various types of flame retardants but amongst those that have caused the most concern to date are those that fall within the class called brominated flame retardants. These chemicals are persistent in the environment and can stay in the body for several years. Many types of flame retardants within this class now have restricted uses or are banned from use altogether. While widespread in the environment,⁶⁰ with bans in place levels should start to slowly fall.

Exposure to brominated flame retardants is mostly through food but also from household dust (ingestion, inhalation and through skin). The highest dietary exposure in the European population tends to be from fish, whereas exposure in the US is mostly from meat and dairy products another important source. These compounds have a low acute toxicity; however, the concern in respect of human health is long-term interference with the thyroid hormone system because there is some structural similarity between the chemicals and thyroid hormones. They are thus classified as EDCs. In addition, because of the propensity of brominated flame retardants to accumulate in lipid, they can be found at levels of up to 400 times higher (than blood levels) in human breast milk, which could be a concern both because of the levels and the exposure of infants at a susceptible life stage. Though these chemicals are widespread in the environment there is, to date, no known causative linkage between exposure from the environment and adverse health outcomes.

Despite there being no direct linkage to health outcomes, the persistence of these chemicals in the environment means they are being phased out. Where this is possible, without endangering life though rendering products inflammable, it is to be encouraged. The persistent, bio-accumulative nature of these chemicals means that when they get into the environment through inappropriate disposal of waste or other means they are difficult to remove. For these reasons some of the restricted or banned brominated versions are being replaced by other chemicals such as those that use chlorines. Some of these are equally persistent and bio-accumulative which means that it is certain we will be detecting these chemicals and versions thereof in the environment throughout the 21st century. Much of this chemical contamination could likely be avoided by rigorous enforcement of waste disposal.

To determine the necessity of the use of these chemicals much better data are required to determine benefits in terms of lives saved. These data should be assessed alongside hazard and risk data to determine acceptable use in terms of the balance of benefit and risk. Another, more laudable alternative would be to use materials and manufacturing techniques that provide natural flame resistance.

Continuing monitoring will be essential as will further work to understand if there are any health consequences from long term low level exposure to these chemicals. Those that are bio-accumulative should be restricted, or removed from use. This would drive innovation into the development of alternatives that, if released into the environment, would not accumulate there. Examples of innovation could include better materials and manufacturing to provide an intrinsic flame resistance.

New challenges

Risk communication

All of the sections above highlight an area in which attention is still required - risk communication. Many public concerns associated with the use of chemicals stem from misunderstandings about benefits versus risk. All too often hazard is confused with risk, and regulation on a hazard basis does nothing to help this. As science uncovers new mechanistic understanding and, in particular, vulnerabilities, there needs to be a vigorous effort to translate this information into a clear understanding of risk. This can only be accomplished by an understanding of both exposure and mode of action pathways. This information, with associated uncertainties, then needs to be converted into communications that state the case accurately and can be easily understood.

Risk also needs to be assessed alongside benefit. There is a role here for both academics and independent bodies. Ultimately, however, it is going to be government departments and agencies that need to make decisions and provide advice. It is therefore important that real risk is effectively assessed and not confused with perceived risk. Risk assessment should take account of data lacks and uncertainties and communicate effectively hazard and risk assessments and associated uncertainty.

Cross and trans-generational effects

Cross-generational effects are those that occur in the developing fetus and/or the subsequent generation that develops from the germ cells within the fetus as a result of direct exposure in the womb. Trans-generational effects are those that occur in generations not exposed to the original exposure and result from heritable changes in the gametes. Both can lead to adverse health outcomes and have recently developed a higher profile due to new biological understanding. The oestrogenic drug diethylstilbestrol is an exemplar of cross-generational effects. Used in mothers to prevent miscarriage and premature labour, it led to vaginal carcinomas in the female offspring and congenital abnormalities in males.⁶¹ Furthermore, experiments in animals, with a variety of chemicals, have shown high dose exposure in pregnancy during the development of primordial germ cells (that give rise to the gametes) can affect the reproductive organs of both the fetus and/or the subsequent generation that develops from the fetus. An example of such a chemical is the fungicide vinclozolin, which affects the testes, and is passed down the male but not the female line.⁶² Transgenerational effects are less common, where the health outcome is observed in a generation not directly exposed or derived from the exposed gametes.

Studies with vinclozolin and other similar chemicals are largely at high dose (and thus are hazard studies), up to a million fold greater than environmental exposure. Nevertheless, they set a precedent for the existence of chemically induced epigenetic toxicity, and highlight that more research is needed to enhance understanding of risks to human health that could cascade across the generations. There is to date only limited evidence of effects in humans.⁶¹ For example, epigenetic changes in human sperm have been shown to be affected by environmental influences such as smoking behaviour⁶² and paternal smoking has been epidemiologically associated with obesity in sons.⁶³ Together with the evidence from model systems (including potential mechanisms of epigenetic toxicity), the increasing human studies warrants further work in the area.

Susceptibility

Since the human genome was first sequenced in 2003, the cost of sequencing has dropped exponentially and the capacity increased even more. Benchtop sequencers that can sequence the whole genome are available and multiple genomes can be sequenced in a few days. This technology has been applied to many genomes from humans of different backgrounds and animal species. In addition many cancer types have been sequenced. Furthermore the sequencing of epigenetic changes has also been developed. In parallel, computing power and associated software has improved such that these sequences and their analyses are available with a few clicks from a computer mouse.

There have been many net benefits from this work, but one is particularly important for risk assessment – the knowledge of human genome diversity. This diversity can indicate differential susceptibility. To use this knowledge effectively there is a need to understand the mechanism by which a chemical causes toxicity and in particular, the key molecular interactions. Therefore we will have new knowledge that potentially allows assessment of susceptibilities within a human population and can be built into risk management as appropriate. For optimal impact, however, such susceptibility assessments require data that are generated about the mechanism of action, which is currently not typically done for chemicals.

Conclusions

'21st century chemicals' risk assessment will be driven by two factors, new materials, but perhaps more strongly new technology leading to new biological understanding. As more is understood about the interaction of chemicals with biological systems, the risk from legacy chemicals, new chemicals, and chemical mixtures (a particular challenge) will need to be re-assessed on an ongoing basis. Two technologies in particular will drive this development, analytical techniques leading to better and more sensitive measures of exposure and the 'omics methods for the genome, proteins and metabolites that will provide a greater understanding of hazard, mechanisms and susceptibilities.

All these methods will produce large amounts of data that will themselves raise more questions. Therefore the major challenge ahead will not be generating data, but generating the right data and making the right interpretation from all the data available. Care will need to be taken to ensure that the new hazards recognised are real and relevant to human risk. Otherwise, there will be a danger that chemicals will be replaced with substitutes with less desirable hazard profiles. The future is good for the development and use of less hazardous chemicals, and a safer, healthier environment.

References

- 1 Lee, C., Molecular Mechanisms and Determinants of Species Sensitivity in Thalidomide Teratogenesis, in *Pharmaceutical Sciences*. 2013, University of Toronto: <http://hdl.handle.net/1807/36210>. pp. 317.
- 2 McDonald, J.C. and A.D. McDonald, *The epidemiology of mesothelioma in historical context*. Eur Respir J, 1996. **9**(9): pp. 1932-42.
- 3 Landrigan, P.P., et al., *The Lancet Commission on pollution and health*. Lancet, 2017.
- 4 European chemicals Agency. *Read-Across Assessment Framework (RAAF)*. 2017.
- 5 Committee to Review the Health Effects in Vietnam Veterans of Exposure to, H., et al., in *Veterans and Agent Orange: Update 2014*. 2016, National Academies Press (US). Copyright 2016 by the National Academy of Sciences. All rights reserved.: Washington (DC).
- 6 Ngo, A.D., et al., *Association between Agent Orange and birth defects: systematic review and meta-analysis*. Int J Epidemiol, 2006. **35**(5): pp. 1220-30.
- 7 Smith, A.G., et al., *Polychlorinated dibenzo-p-dioxins and the human immune system: 4 studies on two Spanish families with increased body burdens of highly chlorinated PCDDs*. Environ Int, 2008. **34**(3): pp. 330-44.
- 8 Organisation, W.H. Dioxins and their effects on human health. 2017 [August 2017]; Available from: <http://www.who.int/mediacentre/factsheets/fs225/en/>.
- 9 Schecter, A., et al., *Levels of dioxins, dibenzofurans, PCB and DDE congeners in pooled food samples collected in 1995 at supermarkets across the United States*. Chemosphere, 1997. **34**(5-7): pp. 1437-47.
- 10 Laboratory, N.A.E. About Dioxins (PCDD/F). 2017; Available from: http://naei.beis.gov.uk/overview/pollutants?pollutant_id=45.
- 11 Committee on Toxicity of Chemicals in Food, C.P.P.a.t.E., COT Statement 2010/02, 2010.
- 12 Poland, A. and J.C. Knutson, *2,3,7,8-Tetrachlorodibenzo-p-dioxin and related halogenated aromatic hydrocarbons: Examination of the mechanism of toxicity*. Annual Reviews in Pharmacology and Toxicology, 1982. **22**: pp. 517-554.
- 13 Fisher, S.M., K.N. Jones, and J.P.P.J. Whitlock, *Activation of transcription as a general Mechanism of 2,3,7,8-tetrachloro dibenzo-p-dioxin action*. Molecular Carcinogenesis, 1989. **1**: pp. 216-221.
- 14 Whitlock, J.P.P., *Regulation of Cytochrome p-450 Gene Transcription by 2,3,7,8- Tetrachlorodibenzo-p-dioxin in Wild Type and Variant Mouse Hepatoma Cells*. The Journal of Biological Chemistry, 1984. **259**: pp. 5400-5402.
- 15 Whitlock, J.P.P., Jr., *Genetic and molecular aspects of 2,3,7,8-tetrachlorodibenzo-p-dioxin action*. Annu Rev Pharmacol Toxicol, 1990. **30**: pp. 251-77.
- 16 Veldhoen, M., et al., *The aryl hydrocarbon receptor links TH17-cell-mediated autoimmunity to environmental toxins*. Nature, 2008. **453**(7191): pp. 106-9.

- 17 Stockinger, B., et al., *The aryl hydrocarbon receptor: multitasking in the immune system*. *Annu Rev Immunol*, 2014. **32**: pp. 403-32.
- 18 Meldrum, K., T.W. Gant, and M.O. Leonard, *Diesel exhaust particulate associated chemicals attenuate expression of CXCL10 in human primary bronchial epithelial cells*. *Toxicol In Vitro*, 2017.
- 19 Brown, A.S., et al., *Twenty years of measurement of polycyclic aromatic hydrocarbons (PAHs) in UK ambient air by nationwide air quality networks*. *Environ Sci Process Impacts*, 2013. **15**(6): pp. 1199-215.
- 20 Morillo, E., et al., *Soil pollution by PAHs in urban soils: a comparison of three European cities*. *J Environ Monit*, 2007. **9**(9): pp. 1001-8.
- 21 Bull, S. and C. Collins, *Promoting the use of BaP as a marker for PAH exposure in UK soils*. *Environ Geochem Health*, 2013. **35**(1): pp. 101-9.
- 22 Gustafson, PP., C. Ostman, and G. Sallsten, *Indoor levels of polycyclic aromatic hydrocarbons in homes with or without wood burning for heating*. *Environ Sci Technol*, 2008. **42**(14): pp. 5074-80.
- 23 Barbosa, J.M., N. Re-Poppi, and M. Santiago-Silva, *Polycyclic aromatic hydrocarbons from wood pyrolysis in charcoal production furnaces*. *Environ Res*, 2006. **101**(3): pp. 304-11.
- 24 Garcia-Falcon, M.S. and J. Simal-Gandara, *Polycyclic aromatic hydrocarbons in smoke from different woods and their transfer during traditional smoking into chorizo sausages with collagen and tripe casings*. *Food Addit Contam*, 2005. **22**(1): pp. 1-8.
- 25 Inventory, N.A.E. August 2017; Available from: <http://naei.beis.gov.uk/>.
- 26 Totlandsdal, A.I., et al., *The occurrence of polycyclic aromatic hydrocarbons and their derivatives and the proinflammatory potential of fractionated extracts of diesel exhaust and wood smoke particles*. *J Environ Sci Health A Tox Hazard Subst Environ Eng*, 2014. **49**(4): pp. 383-96.
- 27 Ruiz-Vera, T., et al., *Assessment of vascular function in Mexican women exposed to polycyclic aromatic hydrocarbons from wood smoke*. *Environ Toxicol Pharmacol*, 2015. **40**(2): pp. 423-9.
- 28 White, A.J. and D.P.P. Sandler, *Indoor Wood-Burning Stove and Fireplace Use and Breast Cancer in a Prospective Cohort Study*. *Environ Health Perspect*, 2017. **125**(7): pp. 077011.
- 29 Vondracek, J., et al., *Assessment of the aryl hydrocarbon receptor-mediated activities of polycyclic aromatic hydrocarbons in a human cell-based reporter gene assay*. *Environ Pollut*, 2017. **220**(Pt A): pp. 307-316.
- 30 Duis, K. and A. Coors, *Microplastics in the aquatic and terrestrial environment: sources (with a specific focus on personal care products), fate and effects*. *Environ Sci Eur*, 2016. **28**(1): pp. 2.
- 31 Andrady, A.L., *Microplastics in the marine environment*. *Mar Pollut Bull*, 2011. **62**(8): pp. 1596-605.
- 32 Courtene-Jones, W., et al., *Microplastic pollution identified in deep-sea water and ingested by benthic invertebrates in the Rockall Trough, North Atlantic Ocean*. *Environ Pollut*. 2017 Dec;231(Pt 1):271-280.

- 33 Committee, H.o.C.E.A., *Environmental Impact of Microplastics*. House of Commons Report, 2016. **HC179**.
- 34 EFSA Panel on Contaminants in the Food Chain (CONTAM). *Presence of microplastics and nanoplastics in food, with particular focus on seafood*. EFSAjournal 23 June 2016. DOI: 10.2903/j.efsa.2016.4501
- 35 Committee On Toxicity Of Chemicals In Food, Consumer Products And The Environment. *Cot Statement On Dietary Exposure To Phthalates – Data From The Total Diet Study (Tds)*, May 2011. (Available from: <https://cot.food.gov.uk/sites/default/files/cot/cotstatementphthalates201104.pdf>)
- 36 Zarfl, C. and M. Matthies, *Are marine plastic particles transport vectors for organic pollutants to the Arctic?* Mar Pollut Bull, 2010. **60**(10): pp. 1810-4.
- 37 Hussain, N., V. Jaitley, and A.T. Florence, *Recent advances in the understanding of uptake of microparticulates across the gastrointestinal lymphatics*. Adv Drug Deliv Rev, 2001. **50**(1-2): pp. 107-42.
- 38 Wick, PP., et al., *A brief summary of carbon nanotubes science and technology: a health and safety perspective*. ChemSusChem, 2011. **4**(7): pp. 905-11.
- 39 Bergman, A., et al., *State of the science of endocrine disrupting chemicals*. WHO report, 2012.
- 40 Carson, R., *Silent Spring*. 1962, USA: Houghton Mifflin.
- 41 Tyler, C.R., S. Jobling, and J.P.P. Sumpter, *Endocrine disruption in wildlife: a critical review of the evidence*. Crit Rev Toxicol, 1998. **28**(4): pp. 319-61.
- 42 Colborn, T., D. Dumanoski, and J. Peterson Myers, *Our stolen future*. 1996, New York, USA: Dutton Penguin.
- 43 Solecki, R., Kortenkamp, A., Bergman, Å. et al. *Scientific principles for the identification of endocrine-disrupting chemicals: a consensus statement*. Arch Toxicol (2017) 91: 1001. <https://doi.org/10.1007/s00204-016-1866-9>
- 44 Jenkins, S., et al., *Endocrine-active chemicals in mammary cancer causation and prevention*. J Steroid Biochem Mol Biol, 2012. **129**(3-5): pp. 191-200.
- 45 Giwercman, A., et al., *Evidence for increasing incidence of abnormalities of the human testis: a review*. Environ Health Perspect, 1993. **101 Suppl 2**: pp. 65-71.
- 46 OECD, *Detailed Review Paper on the State of the Science on Novel In Vitro and In Vivo Screening and Testing Methods and Endpoints for Evaluating Endocrine Disruptors*. Test. Assess. p. 178, 2012.
- 47 Greally, J.M. and M.N. Jacobs, *In vitro and in vivo testing methods of epigenomic endpoints for evaluating endocrine disruptors*. ALTEX, 2013. **30**(4): pp. 445-71.
- 48 Marczylo, E.L., M.N. Jacobs, and T.W. Gant, *Environmentally induced epigenetic toxicity: potential public health concerns*. Crit Rev Toxicol, 2016. **46**(8): pp. 676-700.
- 49 Armitage, J., et al., *Modeling global-scale fate and transport of perfluorooctanoate emitted from direct sources*. Environ Sci Technol, 2006. **40**(22): pp. 6969-75.

- 50 Young, C.J. and S.A. Mabury, *Atmospheric perfluorinated acid precursors: chemistry, occurrence, and impacts*. Rev Environ Contam Toxicol, 2010. **208**: pp. 1-109.
- 51 Ahrens, L., *Polyfluoroalkyl compounds in the aquatic environment: a review of their occurrence and fate*. J Environ Monit, 2011. **13**(1): pp. 20-31.
- 52 Gomis, M.I., et al., *Historical human exposure to perfluoroalkyl acids in the United States and Australia reconstructed from biomonitoring data using population-based pharmacokinetic modelling*. Environ Int, 2017. **108**: pp. 92-102.
- 53 Steenland, K., T. Fletcher, and D.A. Savitz, *Epidemiologic evidence on the health effects of perfluorooctanoic acid (PFOA)*. Environ Health Perspect, 2010. **118**(8): pp. 1100-8.
- 54 Dewitt, J.C., et al., *Perfluorooctanoic acid-induced immunomodulation in adult C57BL/6J or C57BL/6N female mice*. Environ Health Perspect, 2008. **116**(5): pp. 644-50.
- 55 Weiss, J.M., et al., *Competitive binding of poly- and perfluorinated compounds to the thyroid hormone transport protein transthyretin*. Toxicol Sci, 2009. **109**(2): pp. 206-16.
- 56 Xing, J., et al., *Toxicity assessment of perfluorooctane sulfonate using acute and subchronic male C57BL/6J mouse models*. Environ Pollut, 2016. **210**: pp. 388-96.
- 57 Johansson, N., A. Fredriksson, and P.P. Eriksson, *Neonatal exposure to perfluorooctane sulfonate (PFOS) and perfluorooctanoic acid (PFOA) causes neurobehavioural defects in adult mice*. Neurotoxicology, 2008. **29**(1): pp. 160-9.
- 58 Lai, D.Y., *Rodent carcinogenicity of peroxisome proliferators and issues on human relevance*. J Environ Sci Health C Environ Carcinog Ecotoxicol Rev, 2004. **22**(1): pp. 37-55.
- 59 Leonard, R.C., et al., *Retrospective cohort mortality study of workers in a polymer production plant including a reference population of regional workers*. Ann Epidemiol, 2008. **18**(1): pp. 15-22.
- 60 Linares, 2015
- 61 Rubin, 2007
- 62 Anway, 2005
- 63 Marczylo, 2016
- 64 Marczylo, 2012
- 65 Northstone, 2014

Chapter 04

New horizons

Chapter editors

Professor Alistair Boxall¹, Dr Andrew R H Dalton²

1 Professor in Environmental Science, University of York

2 Public Health Specialty Registrar, *West Midlands* Deanery

New horizons, an introduction

Previous chapters have largely focused on well-understood and well-evidenced impacts of pollutants on health. However, the population will be exposed to many other pollution pressures whose effects on our health are less well understood. For example, one group of chemical pollutants of concern are the so-called contaminants of emerging concern (CECs). These are pollutants that so far have not been studied extensively and which are not routinely monitored, where there is a concern from stakeholders (scientists, regulators, NGOs etc.) that the pollutant may be harming human or environmental health. CECs include pollutants such as nanomaterials, human pharmaceuticals (see Chapter 3 of this report, '21st century chemicals'), natural toxins, veterinary medicines and micro-plastics (see Chapter 7 of this report, 'Environmental health - response to pollution').

Physical pollutants such as light pollution may also be adversely affecting our health, whilst sound is not a new issue – although there is a more recent understanding on the extent of the harm from this pollutant on human health. The world is also rapidly changing due to climate, demographic, technological and land-use changes and these changes will also have implications for the exposure of people in England to both the known pollutants and CECs. In this chapter, we describe some of the concerns around the impact of these more novel pollutants on human health and future drivers of pollution exposure and risks. We highlight the need for future work and potential management interventions to reduce exposure to these substances. We also highlight some of the emerging techniques and methods to combat pollution. This includes advances in methods to ascertain knowledge about the health impacts of pollutants, such as the use of epigenetics, mutational signatures in tumours, and the use of emerging epidemiological techniques.

Noise pollution

This section is authored by Stephen Stansfield, Professor of Psychiatry, Wolfson Institute of Preventive Medicine, Queen Mary University of London

Background

The most frequent human responses to environmental noise are annoyance and sleep disturbance. Annoyance, which includes mild anger and feelings of intrusion of privacy, is also a response to disturbance of activities by noise. The level of annoyance to noise is influenced by many other factors including sensitivity to noise, fear of the noise source, and feelings that the noise producers are taking insufficient care. Annoyance to environmental noise increased in the UK between 2000 and 2012 despite little increase in exposure, suggesting that tolerance of environmental noise has decreased.¹ Noise exposure during sleep induces arousals, delays sleep onset, reduces slow-wave and REM sleep and increases the length of time spent awake.² Short-term effects of noise on sleep include impaired mood, increased daytime sleepiness, and impaired cognitive performance. Generally noise exposure in health studies is measured as the average sound pressure over a specific period using decibels as the unit (dBA is the unit of A-weighted sound pressure level in decibels) weighted according to differences in human hearing sensitivity at different frequencies.

The extent of noise pollution

In 2012, 83% of a survey sample in the UK reported they heard road traffic noise, 72% aircraft noise and 48% noise from building, construction and road works at home in the last 12 months.² Forty eight per cent reported that their home life was 'spoiled to some extent' by environmental noise. Road traffic noise is the most prevalent form of environmental noise exposure. 125 million people across Europe are exposed to noise levels above 55dB_{Lden}, a level at which human health effects are thought to become evident.³ Although cars and planes have become quieter than in the past there are now many more of them.

The health effects of noise pollution

In general, acute responses to noise, defined as unwanted sound, include startle responses and physiological arousal. In the longer term, repeated exposure and arousal may lead to more serious health effects which may be part of the body's response to chronic stress. In recent years studies have shown that environmental noise exposure has been associated with a range of health outcomes (Basner et al, 2014). The mechanism of noise effects on health is thought to be via the stress hypothesis where prolonged noise exposure increases physiological arousal and the secretion of stress hormones such as adrenaline, noradrenaline and cortisol. This causes raised blood pressure and heart rate, raised blood sugar and blood lipids and may lead to arterial endothelial dysfunction.⁴

There is convincing evidence that road traffic noise is linked to increased risk of hypertension (meta-analysis of 24 studies between 1970 and 2010, OR=1.034 95%CI 1.01,1.06 per 5 dB increase in 16hr average road traffic noise level).⁵ There is also a small but consistent risk of coronary heart disease related to road traffic noise (OR=1.08 95%CI 1.04,1.13 per 10dB Ldn increase in road traffic noise).⁶ In ecological studies aircraft noise has been associated with increased cardiovascular disease risk and hospital admissions.⁷ Aircraft and road traffic noise exposure have also been associated with increased risk of stroke^{8,9}, diabetes mellitus¹⁰ and even mortality.^{11,12} Some variation in the magnitude of these associations may be related to noise exposure misclassification and noise levels at residences are only an approximation of noise exposure across the day. One suggestion has been that effects of noise might be explained by concurrent air pollution exposure but Tétrault (2013)¹³ found that the point estimates of the association between road traffic noise and cardiovascular disease changed less than 10% after adjustment for air pollution.

Environmental noise exposure is also related to range of other effects. In children aircraft noise exposure has been linked to delays in children's reading on standard scales in cross-national studies.^{14,15,16} Prenatal exposure to modelled road traffic noise has been related to low birth weight in a large Canadian study, adjusting for the effects of air pollution.¹⁷ However, two contemporary reviews have found no consistent association between environmental noise and prematurity and low birth weight but the studies examined were very heterogeneous.^{18,19}

Noise pollution and the burden of ill health

In order to assess the magnitude of the effects of environmental noise exposure on health the WHO published the burden of disease from environmental noise in Europe, based on noise exposure, the distribution of exposure and existing exposure-response relationships. 61,000 DALYs were attributed to ischaemic heart disease based on hypertension and IHD outcomes, 45,000 DALYs to cognitive impairment in children and young people, aged 7-19 years, 903,000 DALYs to sleep disturbance, 22,000 DALYs to tinnitus, and 654,000 DALYs for annoyance.²⁰

In terms of the health effects of environmental pollution in Europe, environmental noise comes second in burden of disease to air pollution and arguably is responsible for more disturbance of quality of life. Environmental noise is also responsible for more life years lost than other significant environmental pollutants such as lead, ozone and dioxins.²¹

What can be done to reduce noise exposure and consequent health effects?

Interventions to reduce population noise exposure can be considered at several steps along the pathway from the noise source to the receiver.²² Reduction of noise at source is an ideal but often expensive solution such as designing quieter cars and aircraft and the provision of sound absorbing tarmac to reduce tyre noise or grinding rail tracks to reduce noise. More easily achievable source reductions include airport night curfews, changes in numbers of flights from airports and changes in traffic flows on motorways. Interventions between the source and the receiver, such as sound insulation of windows or noise barriers along roads and railways have been shown to be effective in reducing levels of noise exposure.²³ New/closed infrastructure interventions include closure of flight paths, introduction of bypasses and urban planning control such as the avoidance of new buildings, especially sensitive buildings such as schools, close to noise sources. Other physical interventions include the availability of a quiet side to dwellings exposed to road traffic noise which has been shown to reduce annoyance and the availability of green space for psychological restoration.²⁴ Education/communication interventions help to educate people to change behaviour to reduce noise exposure or to explain the reasons for noise changes which may help to reduce community annoyance levels.

At the level of public policy the European Noise Directive requires EU states to map noise levels in urban agglomerations and develop action plans to reduce noise levels in the highest exposed areas.³ This has focused attention on noise as an issue, with increasing effort to standardise data collection across countries, but there is still incomplete data from many areas. In England, the Noise Policy Statement for England^{****} sets out the long-term vision of government noise policy to promote good health and a good quality of life through management of noise. Its aims are to avoid significant adverse impacts on health and quality of life, mitigate and minimise adverse effects and where possible contribute to the improvement of health and quality of life.

**** <https://www.gov.uk/government/publications/noise-policy-statement-for-england>

Light pollution

This section is authored by John O'Hagan, Public Health England

Humans evolved with the sun as the main source of light. Therefore, daily activities took place when it was light: when the sun went down, we sought shelter and slept. Fire provided a form of artificial light, which was developed into lamps by burning oils and then candles. Despite this, one hundred years ago when houses had artificial light in the form of gas lamps, most people's day was still driven by the availability of daylight. The incandescent light bulb and the installation of electrical supplies into factories and homes changed this, extending the day with sufficient levels of light to carry on complex tasks.

Since then lighting has changed. The focus on energy efficiency meant that the incandescent light bulb was phased out, moving to fluorescent lighting and then to LEDs. Fluorescent lamps provided one health concern. Linear fluorescent lamps were known to leak small amounts of ultraviolet radiation, managed using plastic diffusers to filter it or by the distance the lamps were from people. Following concerns from dermatologists, scientists at what is now Public Health England carried out an extensive study of the emissions from compact fluorescent lamps. This showed that some emitted levels of ultraviolet radiation could exceed the exposure limits for workers, especially when used close to the skin. A small proportion of the population appeared to be particularly sensitive to these emissions. However, there were significant benefits to some people who needed a light source, for example, those needing a source close to the page of a book so that they could read.

Ideally, light should be controlled so that it only illuminates the areas where it is required – and only for the times when it is required. Light pollution is not new – the orange glow from sodium lighting above towns and cities has been a problem for decades. LEDs, coupled with well-designed optical systems, provide an opportunity to control light distribution, specifically to ensure that light goes onto the surface to be illuminated and not, for example, into the sky. There are also concerns that 24-hour light may have an adverse effect on flora and fauna.

Moving to a 24-hour society presents some challenges for our bodies. We evolved to experience a reddening sky as we move into the evening. Our melatonin levels should start to increase to prepare ourselves for sleep and to facilitate the body's repair mechanisms. When we get up in the morning, the sunlight should suppress our melatonin levels, whilst serotonin production is increased to prepare us for activities of the day.

In the early 2000s a type of sensor was discovered in the eye, in addition to the long known about rods and cones, which was also sensitive to light. Intrinsically photosensitive retinal ganglion cells (iPRGCs) were identified as the main sensors for entraining our circadian rhythms. Humans have a natural body clock that has an approximate 24-hour cycle. However, light is the main trigger to ensure that we stay entrained. The initial research on iPRGCs, suggested that melatonin suppressed was most effective at a wavelength of about 480 nm (blue light). However, this wavelength is close to the peak wavelength known to cause adverse photochemical changes in the retina, which at high levels can result in eye injury. More recent studies have suggested that the rods and cones also contribute to the body's response to light and circadian processes. Therefore, it is likely that bright light, of almost any wavelength, could have an impact. Disruption of the circadian system can have a major impact on sleep quality and daytime alertness, which in turn impacts wellbeing and safety. It is a bit like having permanent jet lag.

As artificial lighting technology developed, installers recognised the importance of ensuring the observer was shielded from high luminance (bright) sources of light because of glare, which in extreme cases can be very stressful. An obvious example of a shield is the lampshade used in the home. Some LED installations, however, have LED chips visible, which can form a source of glare. An extreme example is daylight-running lights on cars. These are clearly visible to other road users and pedestrians. At night, if they do not dim, they can be very dazzling and more so for young children (who have higher transmission of light through to the retina) and older people (who will suffer from scattering of the light, particularly in the lens of the eye). This means that older drivers, in particular, will be dazzled by oncoming vehicles with the risk that they may not see hazards until too late. The problem is exacerbated by fog.

Local authorities have been replacing mercury and sodium street lights with LEDs. If this is done purely on the basis of energy efficiency and cost, it is possible to end up with installations that may not be fit for purpose. Some streetlight luminaires have LED sources that can be seen physically projecting below the luminaire, becoming a glare source or light pollution. The light spectrum may be enriched in the blue, which may be beneficial for keeping drivers alert, but many people will find the light uncomfortable. High levels of blue light are known to cause damage to the retina in the eye. This only tends to be a problem for blue LEDs and not for white-light LED sources containing a blue LED and a yellow phosphor. It is possible to have LED street lighting that directs the light only to the areas that need to be illuminated, minimising the light that goes in the sky. They can also be provided in a range of colour temperatures, where warmer colours are likely to be more appropriate for populated areas.

Aside from the wavelength and brightness, there may be another impact of LED lighting. Some of the LED sources assessed by Public Health England and others vary in illuminance at a frequency of 100 hertz. At the extreme, the LEDs switch on and off 100 times per second. This is of concern for a number of reasons. Some people seem to be very sensitive to this light modulation, resulting in headaches, migraine and less specific feelings of malaise. However, most people will experience phantom arrays (as happens when you move your eyes quickly when behind a car with its brake lights on, particularly in the dark) and there is the risk of a stroboscopic effect. This effect may manifest itself as moving objects appearing to jump, rather than move smoothly. More seriously, rotating machinery, which could include the blades on a food mixer, may appear to be stationary if the rotation rate matches the modulation rate or is a multiple of it.

Nanomaterials

This section is authored by Alistair Boxall, University of York

Nanomaterials (NMs) are generally regarded as materials that have one or more dimensions of less than 100 nanometres in size. At this size range, the materials have very different properties from their equivalent 'bulk' material and consequently NMs are now being used in a wide range of products including cosmetics, paints and coatings, medicines and medical devices, water treatment technologies and agrochemicals.²⁵ Release of NMs into the natural environment is inevitable. Emission pathways include: entry to air from vehicle exhausts; entry to surface waters from down-the-drain chemicals that are released to the sewerage system or from runoff from highways and buildings; entry to soils through direct application of agrochemicals and the applications of sewage sludge to land as a fertiliser.²⁶ NMs may also occur naturally in the environment or be formed from the breakdown of larger man-made particles such as plastics and polymers.²⁷

The analysis of NMs in environmental matrices is challenging – due to their size - so much of the work done to quantify concentrations of these materials in the environment has involved the use of models. Predictions from these modelling exercises suggest that highest concentrations of NMs in surface waters will be in the tens of microgrammes per litre range in surface waters, tens of mg kg⁻¹ range in soils and 100s of ng m⁻³ in the air compartment.²⁸

Consumers will be exposed to residues of NMs in the environment through breathing contaminated air, the consumption of contaminated soil or drinking water, or through skin contact with contaminated soil or water. NMs can also be accumulated by plants, fish and shellfish^{29,30} so exposure from consumption of contaminated food items may also occur. While it is inevitable that human exposure to residues of NMs in the environment is occurring, there is less direct evidence of this. The only experimental evidence of such exposures comes from studies that used magnetic analyses and electron microscopy to demonstrate the presence of magnetite nanoparticles in the human brain.³¹ They proposed that the most likely source of these particles was from airborne particulate matter pollution.

Modelling studies have attempted to quantify the importance of environmental exposure to a particular NM compared to exposure in occupational and product-use settings. For example, Tiede *et al.* (2015)³² explored the potential exposure of consumers from drinking water. They concluded that for the majority of types of nanoparticles that were studied, human exposure *via* drinking water was less important than exposure via other routes. The exceptions were some NPs from clothing materials, paints and coatings and cleaning products containing Ag, Al, TiO₂, Fe₂O₃ engineered NPs and carbon-based materials. A similar study by Nowack *et al.*, (2013)³³ concluded that environmental exposure to materials used in agricultural production, drinking water treatment, groundwater remediation and in medical textiles is more significant than occupational exposure or exposure during use of a product by consumers.

Evidence for potential effects of NMs on human health generally comes from *in vitro* studies and *in vivo* studies using model test organisms. For example, silver nanoparticles have been shown to reduce lung function, produce inflammatory lesions in the lungs of rats and also to accumulate in the brain.³⁴ At the cellular level, the particles reduce mitochondrial function and increase membrane leakage and alter levels of glutathione.³⁴ Whether or not environmental exposures can result in these types of effects is however, uncertain.

It is inevitable that the English population will be exposed to NMs *via* the natural environment. The degree of exposure will vary depending on the particle and product type and, in a few instances, environmental exposure will be more important for health than other exposure scenarios (i.e. in occupational settings or during product use). NMs do have the potential to cause toxicological effects but whether exposure concentrations are high enough to reach toxic levels is still unclear. As the nanotechnology sector is rapidly growing, and exposure levels will continue to increase in time, there is a real need to begin to better align environmental exposure studies with toxicological studies in order to better characterise the risk of these materials.

Box 1 Health concerns over Carbon Nanotubes

Dr Craig A. Poland and Dr Rodger Duffin, MRC Centre for Inflammation Research, University of Edinburgh

Carbon nanotubes (CNTs) are classified as a 'nano-object' as they have two dimensions within the nano-range (1-100nm) but can have a length many millimetres long. Due to exceptional structural and electrical properties, interest has increased in the commercial use of CNTs within various industries - mostly relating to use within electronics and composites. However, concerns have been raised as to the possible health effects arising from exposure to CNTs owing to their similarity to certain pathogenic fibres, most notably asbestos.

These concerns have led to a significant body of work addressing the respiratory toxicity of CNTs utilising different models. Typical lung responses noted in numerous studies include inflammation, formation of granulomas (typical of a foreign body reaction), fibrosis and lung cancer.ⁱ A significant concern has been whether or not CNTs could reach the pleural cavity and cause mesothelioma, a hallmark cancer of asbestos exposure with a long latency period (>30yrs). Several studies have shown that lung exposure can lead to deposition of CNTs in the sub-pleural region, transition from the lung into the pleural cavity and length-dependent accumulation. The retention of CNTs in the pleural cavity has been shown to cause inflammation, fibrosis and mesothelioma.ⁱⁱ

It is important to note that not all CNTs display the same level of pathogenicity and results are conflicting. This, in part, is because CNTs are produced in a vast array of different shapes and sizes which impacts on toxicity meaning there is a spectrum of toxicity associated with CNT exposure. Broadly, those very short and/or highly curled CNTs, forming a compact structure (<4µm), show a much lower toxicity than those which are longer (>10µm) with a straighter, fiber-like morphology. The association between shape/ length has also been shown for other nanofibres with materials such as titanium dioxide showing greater toxicity with increased length.ⁱⁱⁱ In addition, concern has been raised over platelet-shaped nanoparticles such as graphene-based nanomaterials leading HSE in recent guidance^{iv} to consider nanoplatelets alongside CNTs.

Irrespective of hazard status, the risk of human health effects is very much dependent on exposure. Exposure is most likely to occur in the occupational environment during the production of CNTs as well as the incorporation of CNTs into products further down the manufacture chain (for example addition to a composite resin). Another area of possible exposure is during recycling of CNT containing products. A limited number of studies have shown CNTs (and other nano-carbons) can be produced from anthropogenic sources such as diesel exhaust^v, leading to possible exposure of the public from the general environment. However, CNTs produced from anthropogenic sources are not the same as those shown to cause respiratory toxicity in animal models (for example they are shorter, more compact – generally types thought to be less harmful). The possible impact of anthropogenic CNTs on health is yet to be fully elucidated. Another source of exposure is through interaction with CNT containing products yet exposure to free CNTs is unlikely due to being sealed within products (such as electronic circuitry or embedded within a composite resin).

Numerous exposure limits have been proposed for CNTs based on either mass or fibre number metrics yet there are currently no statutory limits for CNTs or other engineered nano-fibres. Evaluation of CNTs by the International Agency for Research on Cancer led to the classification of a specific multi-walled CNT (MWCNT-7) as a Class 2b carcinogen with all other forms of CNT as Class 3 (Unclassifiable).^{vi}

References

- ⁱ Poulsen et al. (2016) *Nanotoxicology*;10(9):1263-75, Porter et al. (2010) *Toxicology*;269(2-3):136-47, Kasai et al. (2016) *Part Fibre Toxicol*; 13(1):53.
- ⁱⁱ Rittinghausen et al. (2014) *Part Fibre Toxicol*; 11:59
- ⁱⁱⁱ Porter et al. (2013) *Toxicol Sci.*;131(1):179-93
- ^{iv} Health & Safety Executive. (2013) Publication HSG272
- ^v Jung et al. *J Air Waste Manag Assoc.* 2013 Oct;63(10):1199-204.
- ^{vi} IARC (2017) Monograph Vol. 111

Biological pollutants

This section is authored by Bjarne W. Strobel, University of Copenhagen

Natural toxins, agents of biological origin, are chemicals – therefore much of their characteristics as pollutants are the same as synthetic chemicals. Natural toxins are perhaps more familiar as contaminants of food. Examples range from the most acutely toxic, notably toxins that cause Paralytic Shellfish Poisoning to pyrrolizidine alkaloids in honey. Like all chemicals they also have the potential to disperse into the environment and pollute. Probably the most prominent environmental example is cyanotoxins, which are produced by cyanobacteria in harmful algae blooms (HABs) in surface water. Natural toxins are also added to man-made products, such as paint – therefore can pollute down the same pathways as the synthetic chemicals in these products.

HABs, an increase in concentration of algal species that produce toxins, occur in coastal and inland waterways, and are increasing in frequency and magnitude.³⁵ They are often the result of invasive species, or species that take advantage of changed natural environments (temperature changes, nutrient enrichment, droughts etc.) The HABs produce species-specific toxins, such as cyanotoxins. Human exposure can come from ingestion of contaminated fish, shellfish, and drinking water; inhalation; or dermal contact. Health impacts vary widely, based on the specific toxin.³⁶ Another example of a potential biological pollutant in England is the chemical ptaquiloside, produced by bracken. This is a potential human genotoxic carcinogen – but there are a number of uncertainties around the risk and notably around the level of exposure to the public.³⁷

There are currently still many questions about the nature of health impacts of natural toxins, with the field perhaps many years behind our imperfect knowledge of synthetic chemicals. Compared with synthetic chemicals, sources of contamination are much less understood and tend to be located more “remotely” from current monitoring samplers. Toxicity is also more frequently genotoxic, with the potential human health effects currently hard to quantify. Meanwhile, given the formation/release in and into the environment is constant but with degradation (although varying in rate depending on ambient conditions), it is hard to quantify the amounts in the environment using our traditional schemes. That said, exposures are likely very low – although perhaps heterogeneous. Wider advances in monitoring chemicals, such as the NORMAN database (<http://www.norman-network.net/>) – which will allow us to screen chemicals with potential effects on human health) – will help our response to these natural toxins, as well as to synthetic chemicals.

Box 2**Bioaerosols**

Timothy W Gant and Emma Marczyklo, Public Health England

Increasing populations and demands for food at lower cost are having an effect on the way farming and food production are carried out. In particular there has been a shift towards consolidated high density farming operations called intensive farms. These units generate biological and chemical emissions, both from the unit and the waste generated. At the opposite end of the product life there is disposal. With the decreased desire for landfill, more organic matter is being composted in large facilities. Both of these can release bacterial and fungal spores, with fungal spores being more predominant from composting operations. These could have an effect on health, particularly for the development of immune diseases such as asthma.

For intensive farming sites there is evidence of health effects on workers but only limited evidence for health effects in the general population. For composting, there is some evidence of a health effect for those living close to sites. The same applies for the development of asthma in children living near to intensive farming sites.* Conversely there could be health benefits. The so-called 'hygiene hypothesis' states that early life exposure to the type of biological agents that could be associated with intensive farming sites and composting sites could stop the immune system being unduly reactive later in life that could lead to immune disease. There is little evidence for this possible benefit from composting sites and only very limited evidence from intensive farming sites.

Further work must investigate the possible links between intensive farming and composting sites, and effects on health (beneficial or adverse). This will involve the development of better assays to detect the microbial species associated with these facilities. Many of the traditional methods for detecting biological species are limited and not discriminatory. Modern molecular methods must better characterise the biological exposure from these facilities and link these data epidemiologically to health outcomes on small geographical scales.

* Int J of Hygiene & Environmental Health <https://doi.org/10.1016/j.ijheh.2017.10.019>

Impacts of future change on the health risks of pollutants

This section is authored by Alistair Boxall, University of York

Introduction

England is changing: over the next century alterations are predicted in climate, land-use, demographics, physico-chemical properties of the environment (for example acidification), water availability and the degree of urbanisation. Global climate change (GCC), for example, is predicted to result in different weather characteristics in England. The English population is projected to continue growing, reaching over 63 million by 2039.³⁸ The population is also getting older, births are continuing to outnumber deaths and immigration continues to outnumber emigration.³⁸

All of these changes are likely to affect the risks from chemicals and other pollutants in the natural environment to human health by altering:

- a) the types and quantities of chemicals that are released to, or formed in, the environment;
- b) transport, accumulation and fate of chemicals in the environment;
- c) sensitivity of humans to a particular contaminant;
- d) human behaviour (for example Figure 4.1)

Below we discuss some of these potential changes in exposure and risks, focusing mainly on GCC-drivers which is where most work has been done.

Figure 4.1 Potential global climate change (GCC) related and other drivers that will affect the risks of pollutants to human health in the UK in the future

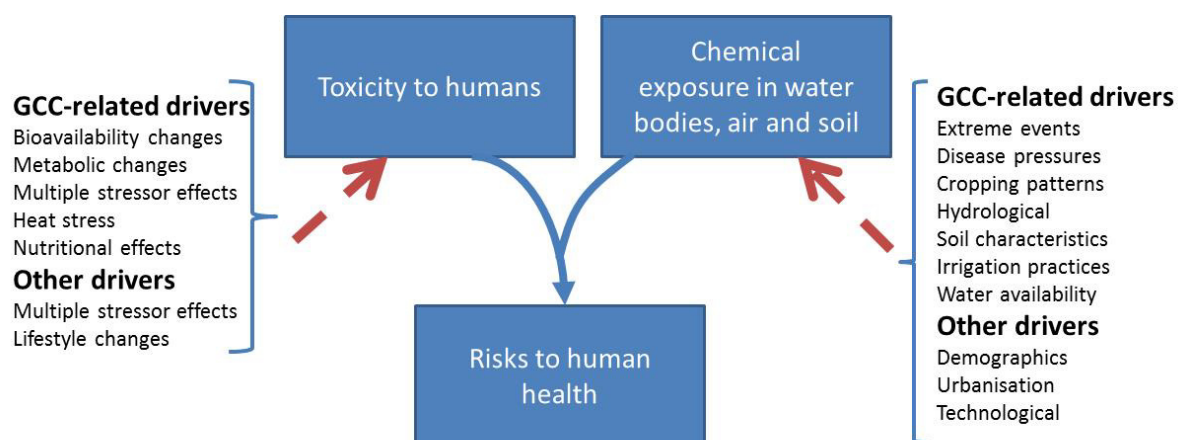

Source Adapted from Boxall et al.

Future changes in climate will impact chemical usage patterns and the amounts used, as well as how chemicals are formed in the natural environment and even alter exposure to existing chemicals. For example:

- For pesticides, biocides and pharmaceuticals, use will likely increase due to changing disease and pest pressures (in addition to increases due to demographic changes).^{39,40}
- As the generation of many natural toxins (for example algal, fungal and phyto-toxins) is partly governed by temperature and moisture, GCC will affect the rates of formation of these substances in the environment as well as their geographical distribution.
- For legacy contaminants, such as mercury, that have been released into the environment in the past and reside in soil and sediments, GCC may alter the environment in such a way that the contaminant can be released more rapidly.⁴¹

As well as the direct impacts of GCC on pollutants (more below), our response will also have impacts on other pollutants. For some chemical contaminants there may be a reduction in emissions to the environment. As many fossil-fuel combustion processes that generate greenhouse gases also emit other harmful air pollutants, decreases in fossil fuel use, resulting from greenhouse gas mitigation policies, will reduce ground-level air pollution by particulate matter and ozone in urban areas.⁴¹ Conversely, shifts to some types of biofuels may increase levels of air pollution in rural areas.

GCC and pollutant pathways

Transport pathways for chemicals will be affected by changes in climate conditions which will affect human exposure.⁴² Aerial transport of chemicals, for example, is dependent on the surface temperature, air temperature and wind speed, all of which are predicted to change as a result of climate change. Increases in temperature resulting from GCC will result in increased volatilisation: this will increase long-range transport of persistent organic chemicals, such as PCBs and dioxins, and local bystander exposure to chemicals such as pesticides.⁴¹ Increases in the occurrence of extreme weather events, such as floods and droughts will alter the mobility of contaminants, providing pathways by which chemicals can move from contaminated areas such as contaminated land sites and sediments to uncontaminated areas. On the land, alterations in soil characteristics such as reductions in soil organic carbon content, increases in dustiness and changes in soil hydrology will alter how contaminants are sequestered in soil systems and transported around rural catchments.³⁹ The dilution potential of contaminants in rivers and streams in the UK will also change.⁴³ In agricultural areas, changes in irrigation practices and more reliance on re-use of wastewater, in response to GCC, could also move contaminants from waterbodies and sewer systems onto land.

GCC and pollutant fate

As well as affecting environmental transport processes, GCC will also alter the fate of chemicals. Increases in temperature and changes in moisture content are likely to alter the persistence of chemicals.⁴³ Biodegradation is generally faster at higher temperatures and moisture contents, so faster degradation of organic chemicals would be expected in hotter and wetter regions. Rates of photolysis are also expected to increase in some regions due to reduced cloud cover meaning that photosensitive chemicals will be exposed to higher intensities of UV light. All of these different changes in fate and transport can have both positive and negative implications for contamination of air, surface waters, soils, food and drinking water supplies and air and hence human exposure. The relative changes in exposure will likely vary depending on region and the physico-chemical properties of the chemical itself.

Human vulnerability

Human vulnerability to pollutant exposure will be altered.⁴⁴ Heat makes humans more vulnerable to adverse effects of air pollutants, such as ozone and PM10, so anticipated temperature increases under GCC could increase sensitivity to aerial contaminants. Chemical exposure may also make humans more vulnerable to GCC-driven changes, for example impairment of the human immune system resulting from chemical exposure could increase vulnerability to vector-borne diseases which are predicted to increase under GCC. Human behaviour will also be affected by GCC and this will have implications for exposure.

Impacts of future change on the health risks of Pollutants - Summary

Overall, human exposure and sensitivity to pollutants will be altered in the future. In some instances, these alterations will have a positive impact on exposure and health while in others health impacts may be exacerbated. We therefore urgently need to establish how exposures of pollutants of potential concern could change under different future scenarios and to use the results of such analyses to identify potential interventions to reduce the health impacts.

Box 3 Pollution and the weather

Dr Matthew Hort, Head of Atmosphere, Met Office

The gases and particulates that make up 'air pollution' originate from sources as diverse as transport, industry, agriculture and the natural environment. These sources are also spread out geographically across our cities, countries and the world. Pollution though does not stay located at its source, as once in the atmosphere it is blown, mixed, diluted, removed and reacts with, amongst other things, the wind, humidity, clouds, rain and other chemical compounds.

The weather we experience knows no borders and the winds, systems, and storms evolve, grow and diminish perpetually in a continuum spanning from the local street to the world. Therefore, chemicals and particulates once in the atmosphere can potentially also be transported over distances ranging from a few millimetres to 1000s in km. The transport by the atmosphere also brings together and enables interactions and reactions of and between the gases and particulates. While this is a universal phenomenon it can perhaps be appreciated more easily when we think about specific events: The eruption of the Icelandic volcano in 2014 that resulted in volcanic gases, including Sulphur Dioxide which then created sulphate particles, spreading across Northern Europe; the presence of fine sand from the Sahara on our cars that has been blown all the way from North Africa before being removed from the atmosphere by rain; the intermittent smell of a domestic wood fire on the street or in our gardens; and of course, the clear increase in traffic 'fumes' as we approach major roads and junctions.

This means that the causes of air pollution at a specific location can be: predominantly located far away; be an even mix of near and far sources or be predominantly due to local emitters. Even in our cities, while the pollution can be dominated by local traffic emissions it still contains, often significant, elements from sources across the rest of the country, shipping in the surrounding waters, the wider continent and also the rest of the northern hemisphere. As such, while it is often correct to focus on local sources for local effects, it is however wrong to do this to the exclusion of considering the contribution and impact from the wider geographical area. The meteorology and dispersion after all follow the rules of physics and chemistry rather than administrative or societal boundaries.

Epigenetic changes and the environment

This section was authored by Paolo Vineis, Imperial College London

Environmental changes of the past have had consequences on the genetic characteristics of certain populations, such as selecting gene variants. For example, the migrations from the Fertile Crescent of the Middle East to Northern Europe (between 5,000 and 10,000 years ago) led to selection among the new settlers of the northern countries of the traits for tolerance to lactose and the diffusion of fair skin. Both mutations emerged in all likelihood to make up for the deficiency of Vitamin D, due to reduced exposure to the sun in northern countries. These adaptations appeared through selection of favourable genetic mutations in the migrant populations.

It is unlikely, however, that slow changes in the genetic make-up of populations, that is, in the DNA sequence, dominated the response to rapid changes linked to globalisation (for example in diet). It was likely due to faster epigenetic changes, which are only now beginning to be understood in detail. These are functional changes, in how the DNA is expressed – or more simply used – which are reversible and transmissible from one cell to its daughters. They are not structural changes, such as in the sequence of the DNA bases.

To give an example of how the environment impacts on one type of epigenetic change; methylation is a change, the binding of a molecule, to the DNA that affects how it is used in a cell. Work is examining the impact of air pollution on the methylome, a record of all of these methylation changes. Long-term exposure to air pollution has been associated with several adverse health effects including cardiovascular, respiratory diseases and cancers. However, underlying molecular alterations remain unclear. This work investigates the effects of long-term exposure to air pollutants on DNA methylation at functional regions (elements of the genome known to code for proteins) and at a certain recurring DNA sequence (CpG sites) that is methylated differently at the same site in different human tissue, with this methylation associated with disease. Findings suggest that global hypomethylation (the absence of this methyl molecule binding) is associated with air pollution. Further, methylation in both the genes and these CpG sites are mostly affected by exposure to NO₂ and NO_x. Previously, hypomethylation has been associated with genetic instability, greater probability of mutations and increased risk of disease. The investigation of epigenetic changes is believed to be one of the most promising fields of research on the mechanisms that explain the impacts of environmental changes – including from pollution - on health.

Box 4 Mutational signatures – a record of environmental exposure?

David Phillips, King's College London

Whole genome sequencing of human tumours has revealed distinct patterns of mutation that hint at the causative origins of cancer. Some of these signatures can be attributed to environmental causative agents, while others suggest defects in cellular processes that maintain the integrity of the genome. A large proportion of the signatures are, as yet, uncharacterised.

Mutational signatures can be generated experimentally by exposing cells to mutagens. In cancers for which tobacco smoking confers an elevated risk, smoking is associated with increased mutation burdens of multiple different mutational signatures, which contribute to different extents in different tissues. One of these signatures, mainly found in tissues directly exposed to tobacco smoke, is attributable to misreplication of DNA damage caused by tobacco carcinogens as it closely matches the signature induced in cells by exposure to benzo[a]pyrene, a tobacco carcinogen. Others likely reflect indirect activation of DNA editing and of an endogenous clock-like mutational process.

Some other cancers also have mutational signatures indicative of an environmental exposure: aflatoxin in liver cancer, aristolochic acid in urothelial cancer, ultraviolet radiation in melanoma. Air pollution contains a complex mixture of mutagenic carcinogens. Whole genome sequencing of tumours attributed to air pollution may yet reveal a characteristic mutation signature or signatures linking their causation to the environmental carcinogens present in urban air.

Advances in epidemiology

This section was authored by Dr Giovanni Leonardi (Public Health England); Tony Fletcher (LSHTM)

Addressing pollution needs a new epidemiology that integrates measurements from across pollution-relevant domains, to human domains. When planning ahead for which chemicals would be safe for society to use, regulatory toxicology has a clear role to play, however once people are unfortunately exposed, epidemiology can have a crucial role. Indication of the value of integrating measurements from several pollution domains using epidemiology has come from several recent results. These include the recognition and quantification of effects of several environmental exposures on (1) growth and physical development; (2) behavioural and cognitive development; (3) asthma and allergies; (4) sexual and reproductive development.

Both toxicology and epidemiology can provide some integration, but have often failed to include information to provide quantitative estimation of parameters sufficiently relevant to a societal level capacity to intervene. The first failure is to ignore population level distribution of benefits and hazards attributable to a chemical compound, mixture, or other environmental factor, the second is to address these aspects by exceedingly weak methods, inadequate to reach conclusions about either causal relationships or relevant interventions. In anticipating future challenges that do not allow time for a prolonged and laborious examination of overlapping and conflicting factors over decades, epidemiology has the potential to provide valuable and quantitative indication of the value of an intervention.

Epidemiology is not a tool or method for public health; it is a science essential to public health.⁴⁵ Non-communicable disease (NCD) that has been caused by pollution exposure, and for which preventive interventions exist, would not be acted upon in the absence of epidemiologically-based assessment of population risks and benefits. This applies to pollutants too. This may be counterintuitive when epidemiology has often been vilified in the media for proposing implausible and conflicting interpretations of non-communicable disease. This supposed limitation of epidemiology may be attributed to the general weakness of a science process that does not recognise the benefits of population thinking when addressing population-level issues, more than to intrinsic deficiencies of either epidemiology or the media. Lack of recognition of the essential value of population thinking may be more an issue of general culture and education than technical competence in any given discipline of science. In any case, epidemiologists have produced findings of unique value to understanding and prevention of non-communicable disease, when clear high exposure groups could be defined, as in the example of smoking and asbestos.

Even when pollutant exposure has been lower and more widespread, such as in the case of air pollution, epidemiology has managed to document health impacts. So, it is expected that epidemiologists will be capable of producing other findings of comparable value on other themes such as the challenges summarised throughout this report, if adequately trained and supported. In the future, a population-level assessment of health risk will be helpful whether we consider near-term knowledge needs (five years) such as neurological and other emerging health effects of air pollution and transport, health impacts of airport (and other transport hub) noise, health impacts of waste management approaches such as incinerators and landfill sites, or longer term needs (up to 20 years) where additional foreseeable developments include investigation of potential health impacts of new energy sources (for example shale gas extraction, small modular nuclear reactors), of light from a variety of sources, around current and legacy industrial sites, intensive farming practices, or simply in response to potential needs to revisit issues such as childhood cancer around nuclear sites, power lines, Camelford⁺⁺⁺⁺ etc.

Typically, success in epidemiology in these themes has required careful assessment of environmental exposure pathways and burden of socio-economic and other confounding, and efforts to conduct individual level longitudinal studies as well as ecological and cross-sectional studies before coming to a conclusion on any topic. Examples include results on endocrine effects of persistent pollutant PFOA and other fluorinated compounds, neurological effects of DDT and other chlorinated compounds, and the increasing recognition of the inter-generational effects of pollutants and other environmental stressors by analysis of birth cohort as well as adult cohort studies.

To characterise effective, evidence-based potential interventions to reduce NCD health burden attributable to pollution, epidemiology will be needed as well. This was demonstrated by the experience of Environmental Public Health Tracking (EPHT) programmes in the US and elsewhere, where evaluation of health benefits of complex interventions could be documented by consortia that included agencies responsible for interventions as well as epidemiologists (see box on EPHT in USA – chapter 9). Integration in EPHT of information on a new generation of biomarkers of exposure and disease risk, significantly enriched by mechanistic information, seems feasible.⁴⁶

⁺⁺⁺⁺ In July 1988, 20 tonnes of aluminium sulphate entered the water supply of 20,000 residents of the Camelford area of Cornwall following accidental contamination. This is considered the largest accidental water contamination in UK history.

In conclusion, integration of epidemiology with toxicology is likely needed to design valid studies of potential harm of new and emerging pollutants, and integration of epidemiology with sciences adopted by those resourcing interventions is likely needed to design valid studies evaluating benefits of interventions to prevent NCD.

Box 5 **A breath of fresh air: Novel approaches to behaviour change**
Carolin Reiner, Michael Hallsworth, Toby Park, Elisabeth Costa of the Behavioural Insights Team

Every day we make decisions that directly affect the air quality around us - be it our commute, our choice of car, or the way we heat and light our homes. Cumulatively, these decisions have large environmental implications. In other words: improving air quality requires changes in behaviour, and therefore a more sophisticated account of human behaviour will allow us to make better policy. Behavioural insights can help provide this more sophisticated account.

Consequently, behavioural insights can either suggest new policy options and new kinds of interventions, or improve existing policy options. In terms of new kinds of policy interventions, a recent study where Virgin Atlantic pilots were encouraged to fly in a more fuel-efficient way, demonstrates how behavioural insights can successfully reduce emissions.ⁱ All 355 pilots in the trial were aware their emissions were being monitored, and this fact alone was enough to increase their fuel efficiency. Some pilots also received behaviourally informed “interventions”, such as personal emission targets and feedback on their respective performance, leading to even greater reductions in emissions. Overall, the experiment saved 6,828 metric tons of fuel, which amounts to 21,507 tons of carbon dioxide not emitted.ⁱⁱ

There is great potential for similar interventions to reduce road vehicle emissions in the UK. For example, there is a growing trend among business fleet owners to use in-vehicle telematics to monitor driving style, with insurance companies also starting to use the technology to assess driving safety and risk. While the awareness of being observed is often enough to change behaviour, the use of telematics also opens up possibilities for interventions such as in-vehicle prompts about driving behaviour, tailored fuel consumption reports, the salient highlighting of cost savings, and making social comparisons with more efficient drivers. The latter idea is analogous to successful work by Opower, whose home energy bills have been shown to reduce energy consumption by comparing households’ energy consumption to their more efficient neighbours.ⁱⁱⁱ Similarly, this social comparison could be applied to reduce air pollution.

continues next page

Behavioural insights can also be used to improve existing policy options, like incentives structures used to increase the uptake of a public service or a recommended product, such as low or zero emission vehicles. Scrappage schemes, punitive taxes on more polluting vehicles, or changes to fuel duty are such possible incentives under consideration, and are examples where behavioural insights can be used to structure incentives for maximum impact. For example, we tend to be loss averse (being more motivated by a loss than by an equivalent gain); we often overweight small probabilities (meaning lotteries and prize draws can be more powerful than flat incentives); and we tend to discount the future (meaning upfront rewards are more motivating than delayed ones, and delayed costs are less off-putting than immediate ones). Specifically, for instance, we could make scrappage schemes more salient by introducing a prize draw for everyone who signs up and thereby encourage the uptake of low or zero emission vehicles. New 'behavioural' policy interventions like setting targets to steer driving behaviour are easy to implement and more affordable than traditional policy levers like regulations (for example the diesel ban), and can also improve the effectiveness of existing policies like a scrappage scheme. Their cost-effective nature renders behavioural insights interventions easily scalable and can therefore substantially shift behaviours to clean up the air we breathe.

References

- i Gosnellet et al. (2016). Working Paper (22316). National Bureau of Economic Research
- ii Lambert et al. (2016).
https://www.virginatlantic.com/content/dam/vaa/documents/footer/sustainability/VAA_Captains_Study_Summary_FINAL_170616.pdf
- iii Olig & Sierzhula (2016) Evaluation Report. Navigant Consulting.

Suggestions for policy makers

This section was authored by Alistair Boxall and Andrew R H Dalton.

While the links between many environmental pollutants and human health are well established, our overall understanding of the overall impacts of environmental pollution on human health is actually quite limited. This is because:

- we only monitor a handful of the 1000's of chemical, physical and biological pollutants that an individual will be exposed to over their life time;
- even for pollutants where we have knowledge on exposure, we have a very limited understanding of the effects – particularly for pollutants where exposure is low but occurs throughout an individual's life time; and
- we have limited understanding of the combined effects of multiple exposures to a number of pollutants.

These knowledge gaps could be addressed by:

- The development and application of prioritisation methodologies to identify the 'unknown' pollutants of greatest concern to the UK population and which therefore require further testing and monitoring. This will likely need much better sharing of knowledge and data across different sectors.
- The extension of current monitoring systems (for example for water and air quality) to consider a much wider range of pollutants and to generate exposure data at much more detailed spatial and temporal resolutions allowing us to better establish what different populations are exposed to throughout their day-to-day lives. The introduction of environmental specimen banks would allow us to look back in time as new pollution issues become apparent;
- New models for predicting exposure of individuals to different pollutants in different regions of the country and across a range of timescales;
- The application of new biomonitoring approaches (for example 'omics' – see box) and technologies (for example sensor networks and crowdsourcing of data) to develop information on how the health of individuals varies across space and time.

By combining information for these new systems for monitoring and modelling the exposure and effects of pollutants on the human population with approaches for analysis of 'big data' we should begin to be able to generate a much better understanding of the impacts of the plethora of the environmental pollutants that we are exposed to on our health meaning that interventions can be focused on those pollution threats that really matter.

References

- 1 Department for Environment Food and Rural Affairs. National Noise Attitude Survey 2012 (NNA2012). Survey Report. December 2014.
- 2 Basner M, Babisch W, Davis A, Brink M, Clark C, Janssen S, Stansfeld S. Auditory and non-auditory effects of noise on health. *Lancet*. 2014, 383, 1325-32.
- 3 European Environment Agency, Noise in Europe 2014. EEA Report No 10, 2014, European Environment Agency: Copenhagen.
- 4 Münzel T, Gori T, Babisch W, Basner M. Cardiovascular effects of environmental noise exposure. *Eur Heart J*. 2014;35(13):829-36.
- 5 Kempen E van, Babisch W, The quantitative relationship between road traffic noise and hypertension: a meta-analysis. *Journal of Hypertension*, 2012. 30: p. 1075-1086.
- 6 Babisch W, Updated exposure-response relationship between road traffic noise and coronary heart diseases: a meta-analysis. *Noise and Health*, 2014. 16(68): p. 1-9.
- 7 Hansell AL, Blangiardo M, Fortunato L, Floud S, de Hoogh K, Fecht D, Ghosh RE, Laszlo HE, Pearson C, Beale L, Beevers S, Gulliver J, Best N, Richardson S, Elliott P. Aircraft noise and cardiovascular disease near Heathrow airport in London: small area study. *BMJ*. 2013; 347: f5432.
- 8 Sørensen M, Hvidberg M, Andersen ZJ, Nordsborg RB, Lillelund KG, Jakobsen J, Tjønneland A, Overvad K, Raaschou-Nielsen O. Road traffic noise and stroke: a prospective cohort study. *Eur Heart J*. 2011;32(6):737-44.
- 9 Floud S, Blangiardo M, Clark C, de Hoogh K, Babisch W, Houthuijs D, Swart W, Pershagen G, Katsouyanni K, Velonakis M, Vigna-Taglianti F, Cadum E, Hansell AL. Exposure to aircraft and road traffic noise and associations with heart disease and stroke in six European countries: a cross-sectional study. *Environ. Health*. 2013; 12: 89.
- 10 Dzhambov AM. Long-term noise exposure and the risk for type 2 diabetes: a meta-analysis. *Noise Health*. 2015;17(74):23-33.
- 11 Huss A, Spoerri A, Egger M, Röösli M; Swiss National Cohort Study Group. Aircraft noise, air pollution, and mortality from myocardial infarction. *Epidemiology*. 2010 Nov;21(6):829-36.
- 12 Halonen JI, Hansell AL, Gulliver J, Morley D, Blangiardo M, Fecht D, Toledano MB, Beevers SD, Anderson HR, Kelly FJ, Tonne, C. Road traffic noise is associated with increased cardiovascular morbidity and mortality and all-cause mortality in London. *Eur Heart J*. 2015 Oct 14;36(39):2653-61.
- 13 Tétéault, L-F, Perron, S, Smargiassi, A. Cardiovascular health, traffic-related air pollution and noise: are associations mutually confounded? A systematic review. *Int. J. Public Health* 2013; 58: 649-666.
- 14 Huss A, Spoerri A, Egger M, Röösli M. Swiss National Cohort Study Group. Aircraft noise, air pollution, and mortality from myocardial infarction. *Epidemiology*. 2010, 21, 829-36.

- 15 Stansfeld SA, Berglund B, Clark C, Lopez-Barrio I, Fischer P, Ohrström E, Haines MM, Head J, Hygge S, van Kamp I, Berry BF; RANCH study team. Aircraft and road traffic noise and children's cognition and health: a cross-national study. *Lancet*. 2005;365(9475):1942-9.
- 16 Klatte M, Spilski J, Mayerl J, Möhler U, Lachmann T, & Bergström K. Effects of Aircraft Noise on Reading and Quality of Life in Primary School Children in Germany: Results from the NORAH Study. *Environment and Behavior* 2016; 49: 390–424.
- 17 Gehring U, Tamburic L, Sbihi H, et al. Impact of noise and air pollution on pregnancy outcomes. *Epidemiology*. 2014;25:351–8.
- 18 Hohmann C, Grabenhenrich L, de Kluizenaar Y, et al. Health effects of chronic noise exposure in pregnancy and childhood: a systematic review initiated by ENRIECO. *Int J Hyg Environ Health*. 2013;216:217–29.
- 19 Ristovska G, Laszlo HE, Hansell AL. Reproductive outcomes associated with noise exposure—a systematic review of the literature. *Int J Environ Res Public Health*. 2014;11(8):7931–52.
- 20 World Health Organization. Burden of disease from environmental noise. Quantification of years of life lost in Europe. World Health Organization Europe. Copenhagen, Denmark, 2011.
- 21 Hänninen O, Knol AB, Jantunen M, Lim T-A, Conrad A, Rappolder M, Carrer P, Fanetti A-C, Kim R, Buekers J, Torfs R, Iavarone I, Classen T, Hornberg C, Mekel OCL, and EBoDE Working Group. Environmental burden of disease in Europe: assessing nine 496 risk factors in six countries. *Environ. Health. Perspect*. 2014; 122: 439-446.
- 22 Brown AL, van Kamp I. WHO Environmental Noise Guidelines for the European Region: A Systematic Review of Transport Noise Interventions and Their Impacts on Health. *Int J Environ Res Public Health*. 2017;14(8).
- 23 Nilsson, M.E.; Berglund, B. Noise annoyance and activity disturbance before and after the erection of a roadside noise barrier. *J. Acoust. Soc. Am*. 2006; 119: 2178–2188.
- 24 Gidlöf-Gunnarsson A, Öhrström E. Attractive “quiet” courtyards: A potential modifier of urban residents’ responses to road traffic noise? *Int. J. Environ. Res. Public Health* 2010; 7: 3359–3375.
- 25 Aitken, R.J., Chaudhry, M.Q., Boxall, A.B.A., Hull, M. (2006) Manufacture and use of nanomaterials: current status in the United Kingdom and global trends. *Occupational Medicine*. 56: 300 – 306.
- 26 Gottschalk, F. and Nowack, B. (2011) The release of engineered nanomaterials to the environment. *J. Environ. Monit*. 13: 1145-1155.
- 27 Lambert et al., 2013
- 28 Gottschalk et al., 2013
- 29 Nam, D-H., Lee, B-C., Eom, I-C., Kim, P., Yeo, M.K. (2014) Uptake and bioaccumulation of titanium- and silver-nanoparticles in aquatic ecosystems. *Mol. Cell. Toxicol*. 10:9-17.

- 30 Tripathi, D.K., Shweta, Singh, S., Pandey, R., Singh, V.P., Sharma, N.C., Prasad, S.M., Dubey, N.K., Chauhan, D.K. (2017) An overview on manufactured nanoparticles in plants: Uptake, translocation, accumulation and phytotoxicity. *Plant Biochem. Physiol.* 110: 2-12.
- 31 Maher, B.A., Ahmed, I.A.M., Karloukovski, V., MacLaren, D.A., Foulds, P.G., Allsop, D.A., Mann, D.M.A., Torres-Jardon, R., Calderon-Garciduenas, L. (2016) Magnetite pollution nanoparticles in the human brain. *PNAS* 113(39): 10797-10801.
- 32 Tiede, K., Hanssen, S. F., Westerhoff, P., Fern, G. J., Hankin, S. M., Aitken, R. J., Chaudhry, Q., Boxall, A. B. A. (2015) How important is drinking water exposure for the risks of engineered nanoparticles to consumers? *Nanotoxicology* 10:102-110.
- 33 Nowack, B., Brouwer, C., Geertsma, R.E., Heugens, E.H.W., Ross, B.L., Toufektsian, M-C., Wijnhoven, S.W.P., Aitken, R.J. (2013) Analysis of the occupational, consumer and environmental exposure to engineered nanomaterials used in 10 technology sectors. *Nanotoxicology* 7(6): 1152-1156.
- 34 Marambio-Jones, C., and Hoek, E.M.V. (2010) A review of the antibacterial effects of silver nanomaterials and potential implications for human health and the environment. *J. Nanopart. Res.* 12:1531–1551
- 35 *Environmental Toxicology and Chemistry*, Vol. 35, No. 1, January 2016
- 36 *Crit Rev Toxicol.* 2008;38(2):97-125. doi: 10.1080/10408440701749454.
- 37 Ramwell et al. 2010 Ptaquiloside & other bracken toxins: A preliminary risk assessment; The Food and Environment Research Agency
- 38 Office for National Statistics, 2017
- 39 Boxall, A.B.A., Hardy, A., Beulke, S., Boucard, T., Burgin, L., Falloon, P.D., Haygarth, P.M., Hutchinson, T., Kovats, R.S., Leonardi, G., Levy, L.S., Nichols, G., Parsons, S.A., Potts, L., Stone, D., Topp, E., Turley, D.B., Walsh, K., Wellington, E.M.H., Williams, R.J. (2009) Impacts of climate change on indirect human exposure to pathogens and chemicals from agriculture. *Environ. Health Perspect.* 117, 508–514.
- 40 Royal Commission on Environmental Pollution (2011) Demographic change and the environment. RCEP 29th Report. RCEP, London.
- 41 Balbus, J.M., Boxall, A.B.A., Fenske, R.A., McKone, T.E., Zeise, L. (2013) Implications of global climate change for the assessment and management of human health risks of chemicals in the natural environment. *Environ. Toxicol. Chem.* 32 (1): 62-78.
- 42 Boxall, A.B.A. (2014) Global climate change and environmental toxicology. In: Wexler, P. (Ed.), *Encyclopedia of Toxicology*, 3rd edition vol 2. Elsevier Inc. pp. 736-740
- 43 Bloomfield, J.P., Williams, R.J., Gooddy, D.C., Cape, J.N., Guha, P. (2006) Impacts of climate change on the fate and behaviour of pesticides in surface and groundwater – a UK perspective. *Sci. Total Environ.* 369: 163–177.

- 44 Noyes, P.D., McElwee, M.K., Miller, H.D., Clark, B.W., Van Tiem, L.A., Walcott, K.C., Erwin, K.N., Levin, E.D. (2009) The toxicology of climate change: environmental contaminants in a warming world. *Environ. Int.* 35: 971–986.
- 45 Pearce N, Lawlor DA. Causal inference—so much more than statistics. *International Journal of Epidemiology*. 2016 Dec 1;45(6):1895-903
- 46 Chadeau-Hyam M, Campanella G, Jombart T, Bottolo L, Portengen L, Vineis P, Liquet B, Vermeulen RC. Deciphering the complex: Methodological overview of statistical models to derive OMICS-based biomarkers. *Environmental and molecular mutagenesis*. 2013 Aug 1;54(7):542-57.

Chapter 05

Economics of pollution interventions

Chapter lead

Laure de Preux¹

Chapter authors

Laure de Preux¹, Franco Sassi²

1 Assistant Professor in Economics, Imperial College Business School

2 Professor of International Health Policy and Economics, Imperial College Business School

Summary of key points

Interventions to reduce pollution have the potential to increase social welfare through improvements in health, social and economic outcomes. This potential has been shown in a range of economic analyses focusing on specific interventions. In this chapter we present evidence from studies focusing on the health impacts of environmental interventions that have been evaluated with an economic perspective. Overall, this body of evidence is strongly suggestive of beneficial welfare impacts from most interventions. However, there remains significant scope for expanding and strengthening the current evidence base in order to provide clearer guidance to policy makers in policy design and investment decisions. Salient points made in this chapter include:

- England has successfully managed to “decouple” trends of economic growth and polluting emissions, achieving reductions in emissions of a large range of pollutants with an expanding economy. However, the detrimental health impacts of current levels of pollution are still large, as are the potential benefits of taking more incisive actions against pollution.
- Economic analysis approaches typically applied in the appraisal of environmental interventions are at odds with those prevailing in the health care domain. A gold-standard economic evaluation approach in the area of environmental health interventions should take a societal perspective and aim at assessing overall impacts on social welfare. Available evidence neglecting these key components underestimates the net benefit of pollution reduction measures.
- Research’s priorities should now be the evaluation of the societal benefits of pollution measures in order to justify economically beneficial interventions that reduce individuals’ pollution exposure or remove the source of emissions.

Introduction and background

Understanding the consequences of pollution requires a multi-disciplinary approach, and the perspectives of multiple stakeholders must be accounted for in designing effective solutions. Economics can play a crucial role in understanding individual behaviours – how individuals respond to different types of incentives - and in assessing the economic impacts of interventions to curb pollution. Pollution is often viewed in economics as a negative externality of an activity, particularly for health and the environment, yet the economic output generated by the underlying activity contributes to increasing welfare. Economic analysis applies to this problem through two principles: (a) efficiency, i.e. the marginal (incremental) social benefits of an activity must always exceed the marginal social costs involved (e.g. from pollution); and, (b) equity, i.e. if different subjects enjoy the benefits of the activity and bear the costs involved, some form of redistribution is required.

Pollution has been perceived by some as a necessary evil on the way to prosperity and economic development. The economic hypothesis linking growth and pollution has been portrayed as an inverted U-shape, referred to as the “environmental Kuznets curve”, reflecting the observation that some emissions tend to increase in parallel with economic growth up to a certain level of income, until they peak and start decreasing as income grows further. This concept applies in different ways to different countries and types of emissions.¹⁻³ The key principle is the existence of a turning point, at which the “decoupling” of emissions and economic growth happens, with emissions starting to increase at a slower pace than economic growth (relative decoupling) and eventually decreasing with further economic growth (absolute decoupling).

A DEFRA assessment showed that absolute decoupling of emissions of a wide range of pollutants has been achieved in the United Kingdom since 1990, including CO₂, which is typically less amenable to decoupling.⁴ While population and consumption increases are typically the strongest drivers increasing emissions, changes in production technology and in the mix of products consumed are typical drivers acting in the opposite direction. However, the Lancet Commission on Pollution and Health has warned against simplistic interpretations of the Kuznets curve, which may lead to complacency about pollution on the assumption that economic development will eventually fix the problem.⁵ Achieving the decoupling of economic growth and emissions requires effective environmental policies, including appropriate forms of regulation and incentives for the use of non-polluting technology and energy sources. Pollution is a hindrance to further economic growth⁶ and reducing levels of pollution has beneficial impacts on the economy. In the

case of air pollution, each dollar invested in control measures has been estimated to yield economic benefits of about \$30 US.⁵

Evidence of the balance between the costs and the benefits of interventions is essential to the design and implementation of effective and efficient policies. This helps policy makers to understand not only the full extent of the consequences of those policies but also the critical uncertainties around policy impacts and future pollution scenarios.⁷ Given the established and important health impacts of pollution, a sound economic evaluation of an intervention to reduce exposure to or emissions of pollution should include an assessment of the value of the health benefits of the reduced exposure and of the possible impacts on the demand for health and social care. Ideally, a proper economic evaluation should also account for the indirect effects of pollution, namely the productivity loss and the cost to the ecosystem.

The aims of this chapter are: (1) to review the most robust evidence from economic evaluations of interventions to reduce pollution, or exposure to pollution, which have duly accounted for the health consequences of such actions; and, (2) to highlight interventions that have been associated with favourable health and economic impacts. In the rest of the chapter, we present the findings of a literature review^{xix} designed to identify comprehensive economic evaluations of policy interventions aimed at reducing pollution in the UK, or in countries at a comparable level of economic development. We also provide an overview of the main types of policy interventions that have been implemented and evaluated to reduce pollution and its impacts on mortality and morbidity.

^{xix} See Appendix 2 of this report (literature review) for more details.

Different types of economic evaluation

Economic analyses of environmental interventions cut across two fields (health and environment), which typically adopt different evaluation approaches. In health economics, the focus is traditionally on how effectively health care resources can be used to improve the health of individuals and populations, typically through cost-effectiveness analysis. In environmental economics, a welfarist cost-benefit analysis approach prevails, aimed at assessing whether interventions have an overall positive impact on social welfare.

A gold-standard economic evaluation approach in the area of environmental health interventions would typically take a societal perspective, in order to account for the broad range of consequences that may accrue to different subjects, in different time frames, and with different levels of uncertainty; and would aim at assessing overall impacts on social welfare resulting from the intervention. However, many economic evaluations of environmental policy interventions account for only some of the wide-ranging impacts (health, economic, social, environmental) of such interventions. As a result, the net benefits of interventions calculated in different studies are often not directly comparable to each other.

The impact of an intervention is either assessed directly by comparing the observed pre- and post-experiment outcomes (cf. Box 1 for an example), or derived or simulated using an **impact pathway approach** (IPA⁸). IPA combines different sources of information and model estimates. In a typical IPA study, one quantifies the change in emissions associated with the intervention, applies a dispersion model, relies on concentration-response functions to derive the health impacts, and translates the effects into a monetary value. Depending on the objective of the analysis, this approach may also cover non-health impacts such as changes in lifestyle, or environmental consequences.

Health impact assessment (HIA) methods, i.e. IPA focusing on health impacts, have been used to document the wide and complex impacts of pollution on health and mortality (e.g. ⁹⁻¹²), but individual studies often assess only selected dimensions of those impacts. Assessments also provide estimates with large margins of uncertainty, due to the complexity of the relationship between environmental exposures and health.^{13,14} Outcomes in HIA can be expressed in different metrics and guidance is lacking on how to select the most appropriate metric in a specific context.¹¹

Monetisation of the health impact

In order for the health impacts to be taken into account into an economic evaluation, they have to be expressed in a unit comparable to the costs of the intervention. The objective of this session is to review the main methods available to monetise health impacts. Table 5.1 summarises the main conversion methods. Monetary values offer significant advantages over in-kind outcome measures. They can summarise multi-dimensional outcomes (including non-health outcomes) into a single metric, which is the same metric used to assess costs in the economic evaluation.

Table 5.1 Summary of main monetisation methods

Health economic technique	Description	Pros and cons
Unit costs	This approach values each unit of health outcomes, for example healthcare resources affected, the number of new morbidity or mortality cases.	It costs individually each aspect, yet not all the unit costs are always available (e.g. the cost of treating all the diseases affected by pollution such as the cost of depression)
Willingness-to-pay (WTP)	Maximum monetary value that individuals are prepared to pay for something such as the removal of pollution exposure, or noise from traffic. This measure is typically extracted from surveys.	It provides a holistic figure that cover the direct and indirect costs as perceived by the payer. However, it is context specific and lacks clarity on what is and is not accounted for. It also depends on the individuals' ability to pay and it may not be representative of the overall population.
Value of a Statistical Life (VSL)	It is the total WTP of a population to save one statistical life, or in other words, the risk of death.	

From an economic perspective, health outcomes can be valued along multiple dimensions. These include the health care costs involved, the productivity losses incurred, and also intangible costs such as the pain and suffering associated with a disease. A simple health valuation can be the costing of each health units affected by interventions. For example, if pollution is affecting the number of asthma cases, this health impact can be translated into the healthcare cost of treating these additional cases. Yet, this approach is limited when it comes to the costs of intangible direct and indirect health impacts such as mortality and loss in productivity. The literature values premature morbidity to about 30,000£ to 60,000£ a year.

The **willingness-to-pay (WTP)** addresses some of these limitations and is often used to have a price of non-market goods such as pollution. The WTP is the maximum price that an individual is willing to pay, typically here to avoid the consequences of pollution exposure. Although this measure is abstract and varies by participant (e.g. as a function of income, or the nature of health risks), it has the benefit of capturing some of the less tangible costs and indirect impacts, such as the value placed on a cleaner home.¹⁵ The main empirical approaches for the elicitation of such values are contingent valuation, revealed preferences, and human-capital valuation. The contingent valuation method requires the participants to state their willingness to pay contingent on the hypothetical provision or removal of a good or service. It is captured through appropriately designed surveys. The revealed preferences method requires observational data on price responses, or preferences can be elicited by offering survey participants different trade-offs (e.g. wage/risk trade-offs in the labour market). The main limitation of these methods is that they do not capture unknown risks to the individuals. For example, if individuals do not know or understand that pollution is harmful, their WTP will be low. Finally, the human capital evaluations proxy the value of health improvements as the difference between the decreased consumption of health care and the increased production, typically based on earning.¹⁶

Aggregate WTP can be used to derive the **value of a statistical life (VSL)**, which represents the sum of what a population would pay to remove a specific risk. A number of reviews have been undertaken of monetary values reported for a statistical life or for particular health risk reductions (e.g. Viscusi, 1992). These have consistently shown large ranges of variation, but also some clearly identifiable patterns (by valuation approach, individual characteristics, or characteristics of health risks). The problem of identifying a monetary value for a statistical life can be viewed as the derivation of a demand curve for health, in which different levels of willingness to pay are linked to specific health risk reductions. The use of WTP values in international comparisons means that estimates of the cost associated with pollution tend to be higher in

high-income countries, but smaller as a proportion of income compared to low- and middle-income countries.¹⁷

In a world with limited resources, and where choices must be made on where priorities should be, welfare economics offers a systematic approach based on a simple logic. Welfare economics is concerned with formulating and justifying propositions by which alternatives may be ranked.¹⁸ The starting point of welfare economics is individual utilities (or wellbeing), and the final aim is achieving a social maximum welfare derived from individual desires and preferences.¹⁹ Prioritising effective interventions in welfare economics is made easier by comparing the net benefits of interventions. The algebraic difference between the benefits and costs is the net value of the intervention, and a positive net present value implies an efficient use of resources from an economic perspective. However, applying this logic does not leave much room for judgements on the distributional implications of alternative allocations generally, although the use of equity weights is possible. The ranking of alternatives can be achieved using cost-effectiveness or cost-benefit analysis.

The health economic evaluation literature in health care settings often relies on **Cost-Effectiveness analysis (CEA)**. CEA takes the perspective of an identified decision maker, typically a health care provider, and adopts a narrow view on the direct benefits and costs of health care interventions. Benefits are measured in natural units (e.g. survival rates, life expectancy, life years gained, etc.). The normative nature of CEA remains confined to the maximisation of a specified objective function (e.g. aggregate quality adjusted life expectancy^{xx}) within a budget constraint. CEA ratios for a comprehensive series of (non-mutually exclusive) interventions that compete for the same pool of resources and then compared in a CE league table. Interventions with the lowest CE ratios are in principle selected as efficient uses of existing resources.

Supporting policy makers who have to ultimately choose interventions across a range of options with different health outcome benefits is made easier by comparing the benefits and costs translated into monetary units. **Cost-Benefit analysis (CBA)** has its theoretical basis in welfare economics, whereas CE analysis retains a weaker link with economic theory. A simple CBA compares the direct cost of the intervention, and translates the health impact into a monetary value. This method is appropriate if most of the benefits are expected to be captured by health outcomes. However, if there could be large

^{xx} The pharmaeconomy literature would refer to cost-utility analysis when the quality of life is taken into account.

indirect impact, the true costs and benefits are likely to be much larger once the indirect impacts are accounted for.

A few authors are referring to “extended Cost-Benefit” analysis to include hidden and external costs not normally account for in decision making.²⁰ But due to the lack of data, this is rather a narrative than a summary figure.

Societal and environmental impact

The regulation of economic activities that generate pollution is complex because of the extent of the externalities involved, including wider societal and environmental impacts. Societal impacts include the life-long consequences of in utero exposure²¹ and low birth weight²², the cost on children's cognitive development^{23,24}, land value, and damage to properties (e.g. crops), or changes to the provision of public goods (e.g. overcrowded public transports) just to name a few. The impact pathways are virtually unlimited for many pollutants. Significant progress has been made in the estimation of a social cost of carbon²⁵, but there is no systematic approach for estimating the economic burden of other pollutants affecting primarily health, and some impacts may not even be quantifiable.²⁶

Policy interventions to reduce a specific source of emissions often generate additional impacts beyond their primary target. For example, traffic calming measures have the potential to generate “co-benefits” in the form of an increase in physical activity.²⁷ Greenhouse gas reduction policies have the potential to affect emissions of other pollutants, negatively or positively, which could have an impact on health outcomes. Other co-benefits comprise reductions in energy bills when installing more environment-friendly boilers, or healthier food products when switching to less polluting agricultural production process.²⁸ Economic evaluations of environmental interventions should take these benefits into account, as well as possible unintended negative impacts.²⁹

In economic evaluations, if certain cost cannot be estimated, their value is implicitly assumed to be zero. This suggests that many evaluations systematically underestimate the economic costs of pollution, and therefore the benefits of interventions.³⁰

Comparing the different evaluations

It is clear that a complete CBA accounting for a complete societal impact, including the short- and long-term effects is not realistic due to the lack of data to quantify and monetise all the relevant aspects. Therefore, all existing CBAs have limitations: they rely on different hypothesis to depict a complete picture of the costs and benefits of an intervention. Even comparing CBAs focusing solely on health benefits is made difficult by the variety of ways health impacts can be monetised.³¹

Different types of interventions

Policy interventions to reduce pollution have been in place for decades³², but were often not the subject of an economic evaluation to assess their direct and indirect costs and benefits. We describe here the types of interventions that have been analysed in the literature from an economic perspective. Most of the evidence focuses on air quality intervention, but we also review other types of environmental interventions when available. We classified interventions into three categories: pollution exposure reduction, emission reduction, and emission removal. In practice measures rarely fall strictly into one category only as they may also come with some co-benefits that fall into different categories (see Figure 1),^{xxi} but we review interventions focusing on their main objective.

^{xxi} For example, a policy aiming at reducing individual exposure by providing them with their individual levels of exposure through an app primarily falls into exposure reduction as some individuals will take different routes to be less exposed. However, a co-benefit of this policy could be that some individuals decide not to drive to work any more to be less exposed to traffic emissions, and as a result, the policy will achieve an emission reduction.

Figure 5.1 Main types of policy interventions to reduce pollution exposure

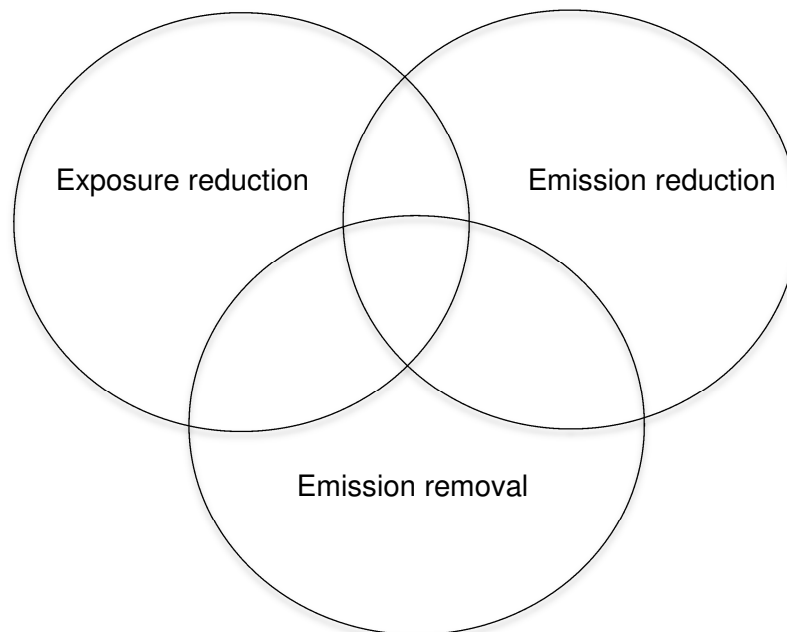

Source Dr Laure de Preux

Exposure reduction encompasses all types of actions that do not address the source of emissions, but the individuals' exposure levels. Often, it can be adopted in the short-run, when more time is needed to reduce or remove the source of pollution, or when changes in the environment are not immediate. Exposure reduction is relatively easy to achieve when pollutants are confined into a specific location.

A more concrete step toward an emission free environment is an **emission reduction** at the source. It can be achieved by reducing the activity emitting, or improving the quality of the emissions. The former is often achieved by a change in behaviour, whereas the latter implies a more efficient process in place.

Finally, **emission removal** requires a complete stop of the source of emissions, which is not necessarily achievable in the short-run, or would be but at a very high cost. Given that there is no healthy level of pollution, emission removal should be the ultimate long-term goal.

The main sources of pollutions and their associated costs

Pollution has been associated with increases in morbidity in some non-communicable diseases, in particular chronic conditions, and excess mortality. The Committee on the Medical Effects of Air Pollutants (COMEAP) advises the government on all matters concerning the health effects of air pollutants, and have estimated the impact of long-term exposure to air pollution on chronic bronchitis, the mortality effects and cardiovascular disease related to long-term exposure to air pollution, yet they do not provide cost estimates of pollution on health and welfare.^{33,34,xxii} Estimates of the morbidity and societal costs associated with pollution are limited, although they represent the largest share of the economic burden as looking after individuals with different morbidities is costly.

The cost impact estimates for various types of pollutants vary greatly. The difficulty in comparing different figures from the literature comes from the fact that pollutants as well as sources of emissions differ between the different studies. Furthermore, the effect depends on the pollution reference level or specific change analysed. The effect of a small change in pollution levels is not necessarily proportional to a large change.^{xxiii} In addition, the health or societal burden estimates do not necessarily capture all the direct and indirect effects. The different examples chosen below illustrate the magnitude of the impacts distinguishing between the health associated costs and the overall burden for the society. The figures are not directly comparable as they cover different aspects, estimate the inputs in different ways, and express the results in different units. The Methodology for Cost-Benefit analysis for the Clean Air for Europe (CAFE) programme illustrates the limitations explicitly in this type of exercise.³⁵⁻³⁷

Air quality is currently at the centre of attention. In the UK, exposure to particulate matter has been associated with a reduction of six months of average life expectancy, and a related cost of £16 billion a year.³⁸ The Lancet Commission on pollution and health estimates the current cost of ambient and household air pollution at 117.30 billion 2015 US dollars in the UK.⁵ In London only, PM_{2.5} and NO₂ in 2010 have an associated mortality burden of £1.4 billion and £2.3 billion in 2014 prices, respectively. The number of hospital admissions in London associated with these two pollutants were 2,732 and 419, respectively.³⁹ Traffic has been estimated to cost to the society 0.01-0.09€/km (0.02-0.41€/km for 1996 cars or older) in France.⁴⁰

xxii COMEAP does however suggest a methodology to translate life-year into cost.
xxiii In other words, the effect is not linear.

The Aphekom project estimates the cost of a decrease in air pollutant levels to the WHO air quality guidelines in terms of particulates and ozone.^{xxiv} The authors use a HIA approach and monetise the mortality^{xxv} effect using a willingness-to-pay approach and the morbidity^{xxvi} cost using the cost-of-illness. The estimated monetary gain is €31 billion annually over 25 European cities estimated over 2004-2006.⁴¹ In London, if the benefits of current and planned policies deliver the reductions they are anticipated to, life expectancy would increase by six months.⁴²

Air pollution is not the only type of exposure. The Lancet Commission estimated the cost of lead exposure in the UK at 17.76 billion US dollars, and unsafe water sources to cost 13.23 billion US dollars in the UK only.⁵ Coal-fired power stations are believed to cause 1,600 premature deaths per year, and cost £1.1 to 3.1 billion per year to the society.⁴³ This is to give a sense of the magnitude of the problem.

The health and societal costs of pollution are unarguably high. Yet, given that each estimate is context specific, there is a lack of a range of estimates using the same methodology that allow them to be used in economic evaluation. As a result, very few studies have been able to account for them in a comprehensive CBA allowing us to compare the net societal benefits of different interventions.⁴⁴ We discuss three broad categories of interventions to reduce pollution and present in more details, when available, the net benefits of some specific interventions.

xxiv Box 2 discusses the discrepancy between the current UK limits and those recommended by WHO.

xxv Willingness-to-pay is extracted from a value of a statistical life.

xxvi The authors' only account of respiratory and cardiac diseases.

How to address pollution?

Pollution exposure reduction measures

A first set of interventions to mitigate the health impacts of pollution involves reducing levels of exposure to it. **Exposure reduction** requires a good understanding and measurement of the spread of pollution in the relevant media (e.g. air, water, ground), as well as effective communication to the public. Therefore, exposure reduction often starts with an appropriate monitoring system, the design of which will depend on the source of pollution and specificity of the pollutant (e.g. water pollution from fertilisers used in agriculture is often assessed fortnightly or monthly only⁴⁵). The sampling process to monitor pollutants is normally designed to optimise costs and benefits, as measurements can be expensive (e.g. in the case of milk dioxin monitoring⁴⁶) and need to be justified by their benefits.

Air quality monitoring is the most common. Air quality monitoring technology has improved significantly over the last decade; it has become cheaper, smaller and more reliable. Portable and affordable devices are now available to the public, although their precision varies greatly. Furthermore, air quality networks with continuous monitoring such as the London Air Quality Network (LAQN)^{xxvii} are now accessible to all free-of-charge and increase people's awareness of air quality in their local area. The information from these networks can also be combined with mobile phones' geographical information⁴⁷ to estimate people's exposure to pollution without carrying monitoring devices. Although monitoring is a key element to evaluate the air quality, identify problems, and support changes with factual information, the Royal Borough of Kensington and Chelsea has closed or removed from the LAQN seven out of its nine monitoring stations in October 2017. Monitoring is a cornerstone in air quality improvement, and this decision goes against the evidence reviewed in this chapter.

However, in order to be beneficial, monitoring needs to be complemented by additional information such as overall indicators that are meaningful to the user (e.g. a colour scheme that translates pollution metrics for non-expert into recommendations), alerts of high pollution levels, or practical suggestions to avoid or reduce exposure (e.g. alternative commuting routes). Alerts are effective in informing the public about peaks of pollution^{48,49} but had no clear impact on hospital admissions in a study based in Southampton.⁵⁰ In the case of smog alerts in California, individuals responded to the information, although the effect was mostly limited to the first day of the alerts when there were

^{xxvii} Website of the London Air Quality Network (LAQN).
<http://www.londonair.org.uk/LondonAir/Default.aspx>

consecutive days of high pollution. As the cost of substituting activities between days increases over time⁵¹, alerts would not be effective in case of numerous and repeated peaks. Walking or cycling along a street with low traffic can reduce exposure to some pollutants.⁵² Mobile phone apps that propose alternative routes to individuals using active transport are becoming increasingly popular.^{xxviii} However, the success of these alternatives could be limited by the existing infrastructure in some cities where walkable routes are limited.⁵³ In the future, we should see a more dynamic and personal use of alerts by combining individual exposure and needs (e.g. information on when to take or increase respiratory drugs on the way to school.⁵⁴).

When the source of emissions cannot be modified, retrofitting air filters to the source of emissions can be an effective solution. The Washington State clean school bus program provided \$5 million in annual funding for 2003–2008 for retrofitting old diesel buses, and a conservative benefit–cost ratio was estimated between 7:1 and 16:1, equivalent to a net present value of children’s health benefits between 424,000 and 989,000 dollars per adopter school district⁵⁵ (this study is further detailed in Box 1). Stevens et al. considered retrofitting old cars in Mexico City with either type of diesel particulate filter or an oxidation catalyst, and find positive net benefits. At current prices (2010), retrofit with an oxidation catalyst provided greatest net benefits. However, the authors suggest “as capital costs decrease, retrofit with diesel particulate filters is expected to provide greater net benefits”.⁵⁶ Some authors have modelled building ventilation and retrofitting homes according to certain standards to reduce indoor exposure to outdoor PM_{2.5} using enhanced filtration among others leads to positive net health benefits^{57,58} but empirical evidence is lacking. Others have modelled the optimal ventilation rates to radon, while accounting for the increase in heating cost and have concluded that periodic ventilation in this context should be preferred over a continuous one, but no health impacts have been assessed.⁵⁹

Many more alternatives have been suggested to reduce existing pollution levels, such as planting trees and shrubs⁶⁰, optimal ventilation routines to address various sorts of pollutants but formal economic impact assessments accounting for the health impacts are not available.

xxviii The World Health Organization has developed a Health Economic Assessment Tool (HEAT) to measure the benefits of walking and cycling (World Health Organization, “Health economic assessment tools (HEAT) for walking and for cycling - Methods and user guide, 2014 update,” 2014.). For example in Brighton and Hove, the tool estimated that 30% increase in the number of cyclists during 2007-2010 was associated with a mean annual benefit averaged across 10 years of £220,115, but these estimates do not take into account exposure to pollution.

Indoor air pollution is also a health hazard, but cost-benefit analyses of interventions to improve health outcomes in this context are limited. A study from the Department for Communities and Local Government published in 2009 finds that carbon monoxide caused the poisoning of about 80 individuals in a year in England and Wales, but based on a cost-benefit analysis, the authors found that the installation of CO detectors alongside new gas appliances (already incorporating secondary safety systems) comes at a very favourable cost-benefit ratio (except in the case of solid fuel).⁶¹ A model of indoor air ventilation and filtration has been developed by the EU-funded HEALTHVENT project. Their analysis shows a potential for a significant health risk reduction, but the benefits have not been compared to the interventions' costs.⁶²

Pollution reduction measures

A **reduction of pollution** can be achieved at very different costs and levels of effectiveness depending on the policy instruments. One way to reduce pollution is through economic incentives that **promote more environmentally friendly choices** of products or behaviour. A first step towards a reduction in pollution is to inform the public of the consequences of their choices and offer them alternatives. For example, a reduction in traffic-related emissions can be achieved by encouraging commuters to choose greener transport, such as cycling and walking, by developing appropriate infrastructure in cities. An evaluation of New York City's bicycle lanes programme^{xxix} accounting for a reduced risk of injury, additional physical activity, and reduced pollution resulted in an incremental cost-effectiveness ratio of \$1,297/QALY gained compared to the status quo.⁶³ Active travel also increases pollution exposure, but scientists show that cycling and walking only become harmful after 1 hour and 15 minutes, or 10 hours and 30 minutes per day respectively in high background PM_{2.5} levels.⁶⁴ Of people using different transport modes, pedestrians are the least exposed.⁶⁵ With rising concerns about obesity levels, the co-benefits of a more active lifestyle are also often included in analyses^{66,67} but only limited evidence exists on the success of such initiatives.⁶⁸ An OECD analysis of various voluntary approaches concludes that their effectiveness is still unclear⁶⁹, but these voluntary programmes are difficult to assess due to the myriad of schemes that may overlap, the lack of adequate data on their adoption or their environmental impact, and the estimation of the counterfactual scenario.⁷⁰

Informing the public and promoting greener alternatives is often a low cost policy option^{xxx}, which does not require monitoring and sanctions in the case of non-compliance. On the other hand, regulation comes generally at a cost for governments. Traditional “**command-and-control**” (**CaC**) **policies** based on regulation typically target three aspects of pollution: the *direct emission target*, the *concentration of pollutant* in a specific environment, and the *technology standard*.⁷¹ Direct emission standards are defined as a certain level per quantity and/or unit of time, and a certain quantity is meant to never be exceeded by the source of pollution. Ambient pollution standards specify a maximum concentration level, such as the Directive of the European Parliament and of the Council on ambient air quality and cleaner air for Europe drawn up in 2008.³² Targets cannot be enforced directly and monitoring of the different sources is necessary to achieve the targets.

xxix 45.5 miles of bike lanes constructed in 2015 at a cost of \$8,109,511.47.

xxx This is assuming that providing it does not require massive investment to change an existing infrastructure.

Setting emissions standards does not necessarily guarantee meeting ambient standards, and vice versa due among others to meteorological and hydrological phenomena.⁷¹ Human decision also plays a role in the final concentration of pollution. For example in the case of car emission standards, the overall number of vehicles on the road will affect ambient air quality. Low emission zones (LEZ) and new Ultra Low Emissions Zone (ULEZ) are examples of traffic control measures based on *technology standards*. Vehicles may only enter the relevant Zone if they do not exceed a certain emission threshold, but the mileage they can do within these zones is unlimited. These measures are considered to be the strictest traffic regulations to contain PM₁₀ pollution.³² LEZs have been implemented in different cities (e.g. in Munich⁷², Tokyo, Rome, Sweden^{73,74}), and are due to be expanded in the future. An economic evaluation of the West Yorkshire Low Emission Zone Feasibility Study, where pre-EURO 4 buses and Heavy Goods Vehicles (HGVs) were upgraded to EURO 6 by 2016, generated an annual benefit of £2.08 million and a one-off benefit of £3.3 million compared with a one-off implementation cost of £6.3 million.⁷⁵ The London LEZ (Congestion Charge Zone) was associated with some improvements in air pollution but modest health gains, but their causal link with the LEZ has been questioned due to other traffic interventions being implemented simultaneously.^{74,76} DEFRA has modelled in detail the societal cost and benefits of different pollution reduction measures, including, among others, retrofitting vehicles with pollution filters, LEZs and road pricing. Their findings show large net benefits from measures to reduce particulate matter, particularly those generating larger reductions, but not from measures to reduce ozone.^{77,78} A model-based study of the Stockholm LEZ shows larger benefits⁷⁹ than the London study, and a cost-benefit evaluation of the scheme shows a significant social surplus, with investment and start-up costs offset by the value of social benefits in around four years.⁸⁰

CaC policies have many drawbacks. First, establishing standards is difficult as it requires, ideally, a good understanding of the benefits and costs involved in order to anticipate the impacts of alternative standards. Second, regulatory policies do not encourage further improvement once the pollution level is contained within the set limit. Third, regulation does not account for differences in the marginal cost of abatement between individuals or firms. Fourth, unregulated zones are likely to see a surge in pollution, and this is never explicitly documented. The example provided in Box 2 further illustrates the difficulties involved in implementing standards.

Market-based policies are the main alternatives to CaC measures. The former are policies that “encourage behaviour through market signals rather than through explicit directives regarding pollution control levels or methods”.^{39, p. 19} Examples include taxes, subsidies or tradable permits. SO₂ levels have dramatically reduced over the last 30 years in the U.S., however it is unclear which policy can be held responsible for this decline. Greenstone⁸² evaluated impacts of the U.S. Clean Air Act (1970) over 30 years and found that the legislation classifying counties into attainment and nonattainment categories appears to have had little effect on the observed overall reduction in SO₂. The U.S. Clean Air Act Amendments enacted the Acid Rain Program (ARP) in 1990. Two chemicals are largely responsible for acidifying deposition, sulfur dioxide (SO₂) and nitrogen oxides (NO_x). The ARP established a permanent cap on SO₂ emissions to be achieved with an emission market.^{xxxii} Chestnut and Mills report health and environmental benefits over \$100 billion annually for 2010, compared to \$3 billion annual costs, respectively, accounting for both SO₂ and NO_x reductions.⁸³ Similar systems are costly to implement⁸⁴, but their benefits may largely outweigh the costs involved once health and environmental benefits are fully accounted for.⁸⁵ More generally, the U.S. Clean Air Act passed in 1970 has been associated with a 70% reduction in the concentration of six common air pollutants while GDP has increased by almost 250%.⁸⁶ Its associated reduction in total suspended particulates led to a “one percent decline in total suspended particulates [that] results in a 0.5 percent decline in the infant mortality rate. Most of these effects are driven by a reduction in deaths occurring within one month of birth, suggesting that foetal exposure is a potential biological pathway”.⁸⁷ However, in the long-run, the associated decrease in particulates had little effect on adult or elderly mortality.⁸⁸

The European Union has also implemented regulations on acidification, but the transboundary nature of acid rain means that different stakeholders have different interests in its regulation. The UK has much of its population at risk, and therefore has much to gain from it.⁸⁹ A recent review concludes that “the large reduction of sulphur emissions in both Europe and the United States have resulted in benefits that significantly outweigh the costs” when health effects are accounted for.⁹⁰

^{xxxii} The ARP also regulated nitrogen oxides (NO_x) emissions but in a different way.

Desulfurization of power plants in Germany was studied by Luechinger to identify the impact of a reduction in SO₂ in a natural experiment framework. The study shows an annual gain of 826–1460 infant lives. The lowest health benefit estimate of \$50 per household per year (the highest estimate is \$343) compares favourably with compliance costs ranging between \$33 to \$165 per household per year.⁹¹ Several items of legislation have been passed over the last 40 years in the UK to reduce SO₂, NO_x, or NH₃. At the same time, downward trends have been observed for those pollutants⁹², but that legislation has not been evaluated in a cost-benefit framework.

Household indoor air quality can also be improved by pollution reduction measures. Replacing old boilers has been showed to have a payback period of four to nine years. This is a cost-effective intervention to address fuel poverty but also has air quality co-benefits by reducing NO_x and CO₂ emissions.⁴² A review focusing on asthma concludes that a strategy of reducing exposures to both allergens and pesticides (“integrated pest management” - IPM) is two or three times more expensive than other alternatives.⁹³ Fabian et al. find that “interventions such as IPM and repairing kitchen exhaust fans led to 7–12% reductions in serious asthma events with 1–3 year payback periods”.⁹⁴ Radon remediation programmes in the UK are effective, although the effectiveness varies with the concentration of radon in communities⁹⁵, yet the “current strategy employed in the UK is failing to target those most at risk”.⁹⁵

Agriculture produces a large share of all polluting emissions. Ammonia (NH₃), for example, comes largely from agricultural sources. Ammonia converts into acidifying compounds and also contributes to eutrophication.⁸¹ McCubbin et al. consider livestock management to reduce ammonia emissions in the U.S. through diet optimisation, animal housing practices, animal waste storage, and land application of manure. Their analysis suggests that “a 10% reduction in livestock ammonia emissions can lead to over \$4 billion annually in particulate-related health benefits”.^{81, p.1141}

Schucht et al. compare the costs and health benefits of reducing PM_{2.5} and ozone concentrations in Europe at the 2050 horizon in order to limit the global temperature increase to 2°C by the end of the century. Health benefits include reduced mortality, morbidity and the associated care, and are monetised using willingness-to-pay and value-of-life-year approaches. The study concludes that the “health co-benefits from the ambitious climate policy will at least cover 75%, and may in fact amount to more than 450% of the additional net aggregate air pollution mitigation and climate policy costs”.⁹⁷

Accounting for further co-benefit of these policies, such as increased physical activity, would make the net benefit of these interventions even larger.

Withdrawing pollution measures

The Clean Air Act of 1956 passed in response of the Great London Smog is an example of a ban on certain types of smoke fuels in some specific areas and it successfully solved the problem of SO₂. The Act imposed bans on various pollutants such as aerosol sprays. However, more recent policies on air quality have been less impactful.

Many experts claim that a ban on cars in busy cities may be the only way to tackle pollution, although this scenario has not been evaluated from an economic perspective. Diesel vehicles are responsible for a large share of pollution and even electric cars, which do not emit NO₂, generate particle emissions through tyre, brake disc, and road surface wear.⁹⁸ As electric cars are on average heavier, they generate more non-exhaust particulates.⁹⁹ Furthermore, electricity generation is often not a clean process.¹⁰⁰ A study comparing electric and gasoline vehicles, and accounting for type of electricity generation as well as the short- and long-term, local and global impacts^{xxxii}, found that 90% of local environmental externalities from driving vehicles are simply displaced elsewhere by driving electric cars, although it may be a temporary solution in heavy polluted cities and arguably a way of mitigating health impacts.¹⁰¹ The authors combine a model of vehicle choice, econometrics and an integrated assessment model, and illustrate the heterogeneity in the environmental benefits. A city suffering from large damages from gasoline but provided with a clean energy grid can benefit from a move to electric cars. The authors estimate the average value of a subsidy across the US, based on the economic principle that “subsidy should be equal to the difference in lifetime damages between an electric vehicle and a gasoline vehicle”^{101, p. 3701} and conclude that, on average, the most efficient policy would rather be a tax on polluting vehicles. This illustrates that in high-traffic areas electric cars may improve local air quality, but are not a panacea.¹⁰²

Lead exposure has been significantly reduced over the last years decades thanks to the bans on leaded fuels, paint and plumbing among others in many countries.⁹³ Nevertheless, lead is still present in the environment, in particular in houses that were built when lead-based paint was still permitted. Gould estimated that “each dollar invested in lead paint hazard control results in a return of \$17–\$221, or net savings of \$181–269 billion” in 2006 prices in the US when accounting for medical expenditures and individual’s revenue loss.¹⁰³

^{xxxii} The model includes human health, crop and timber yields, degradation of buildings and material, and reduced visibility and recreation.

Conclusions

In this chapter, we have presented evidence that illustrates the magnitude of the net benefits of the main types of interventions available to mitigate the health impacts of pollution. A systematic direct comparison of interventions is not possible due primarily to the variety of benefits considered and the heterogeneity of methods adopted in the valuation of health and resource impacts. However, some examples exist of studies using consistent approaches to comparatively assess the impacts of wide ranges of interventions, such as an OECD study undertaken by Hunt.⁷⁸

Two points emerge clearly from the evidence reviewed. First, studies assessing a more comprehensive range of impacts of interventions to reduce pollution show larger societal values. Second, there is significant scope for expanding and improving the existing evidence base on the value of many interventions, in order to better support the design and implementation of appropriate policies.

This chapter provides an overview of the impacts and value of existing interventions that have been evaluated, but it does not cover the potential of future policies to reduce pollution. The **success of future policies** will rely on a combination of public engagement and very strict policies to significantly reduce current and future levels of pollution. Modest interventions such as taxing idling cars have to be put in place now, and enforced, but more permanent behavioural changes will be achieved with a better infrastructure. For example, encouraging greener transport choices will be effective with further infrastructure development and information campaigns, for instance to improve public perceptions around the safety of cycling in urban areas.^{104,105}

It is legitimate to expect the **overall cost of pollution**, and thus the overall benefits of interventions, to be significantly larger than those identified in many existing studies. Several facts can support this claim. First, only few studies account for the cost associated with the impact of pollution on morbidity, a major driver of health care and welfare costs, and consider exclusively mortality. Second, most studies focus on individual pollutants and neglect the effects of a simultaneous exposure to multiple pollutants¹⁰⁶, as well as the spill-over effects (positive or negative) of interventions to reduce one pollutant on other pollutants.¹⁰⁷ Third, disentangling the effects of short- and long-term exposures is difficult in empirical studies. Studies tend to take one or the other perspective, and therefore underestimate overall effects. Fourth, if some people adapt their behaviour based on their awareness of pollution, the societal welfare costs of pollution are likely to be underestimated.^{108,109} For example, Moretti and Neidell¹¹⁰ estimated the cost of “avoidance behaviour” to be between 25% and 80% of the total cost of hospitalisations due to ozone in Los Angeles. Finally, technological innovation is rapidly improving energy efficiency and resource use, suggesting that analyses that do not account for innovation prospects may overstate future policy implementation costs.¹¹¹

When more regulations as well as more stringent regulations seem the obvious and right things to do from a public health perspective, one of the consequence of Brexit will be that most of the environmental legislation will cease to apply when the UK leaves the EEA.¹¹²

A lot of attention has been given to air pollution from traffic as it is a major component of ambient air quality, but other sources of emissions such as the manufacturing sector, or electricity generation should not be forgotten. Furthermore, home, school and office environments are where most of the time is spent and more evaluation of simple measures should be supported in order to prioritise interventions.¹¹³

Authors' suggestions for policy makers

- Better monitoring of pollution, and processes in place to access, use and analyse the data. This is an essential aspect for assessing the current situation, and better evaluating interventions in the future. The cost of monitors has decreased significantly over time, but installation and maintenance remain an issue.¹¹⁴ Whereas the objective is the individuals' exposure, technology has permitted to proxy exposure with precise individual's travel trackers¹¹⁵, and pollution dispersion models allows us to have an estimate of individual's exposure. Yet, even if air quality monitors are leading at the moment, air quality has many components and more efforts should be done to measure the various pollutants harmful to health.
- The UK should adopt temporary and long-term measures, as well as implement local and national changes. Mitigation polices should not be considered in place of pollution reduction or removal. Mitigation should be put in place now, reduction and removal is essential to support a healthy population and should be implemented as early as possible. For example, retrofitting taxis is a beneficial intervention, but should be implement in conjunction to more radical and long-term changes such as Ultra-Low Emission Zones (ULEZ) across the cities.³⁹ ULEZ is certainly a more stringent measure, but it is implemented with exemptions and unlikely to be sufficient to reduce traffic more permanently. Allowed vehicles in the zone will still be polluting and traffic can be expected to be reduced for a while as the highly polluting cars are replaced by less polluting cars. Permanent solutions will have to shift traffic to other type of transport (e.g. goods delivered at night by tube in central London). A more global, and permanent perspective should not be omitted. For example, it is not clear how the ULEZ will impact its neighbourhood regions, a broader perspective needs to adopted when implementing these changes.
- Lacks of monetised health impacts that can be accounted for in economic evaluation by no mean justify the use of a missing value in these assessments. The health literature is clear on the impact of environment on health, and if an intervention improves the individuals' hazard exposure, the health benefits and co-benefits, as well as the spill-over effects should be account for by some values different from zero. While more work needs to be done to develop a societal cost of pollution that could be used in policy analysis, some simple alternatives such as updated DALYs for conditions linked with environmental exposure would greatly improve the comprehensiveness of the evaluation.¹¹⁶

Box 1 Retrofitting old buses to improve children's pollution exposure – A state-of-the-art economic evaluation

A robust approach to assess the benefit of an intervention is to compare outcomes before and after the change, while taking into account any other factor that could bias the result. Beatty and Shimshack⁵⁵ implement a state-of-the-art evaluation of a local reduction programme that retrofits diesel school buses with aggressive pollution control technologies in the state of Washington (USA). School buses can pollute twice as much as the average tractor-trailer truck.¹¹⁷, especially in residential areas where they collect children, and interventions to make them cleaner can lead to significant health benefits. A large proportion of children use school buses to travel long distances and remain exposed to high levels of pollutants inside the cabin throughout their journeys.

The study combined detailed data on bus retrofit (about 4,000 buses in 53 school districts) with morbidity (individual inpatient discharges, including the patient's zip code and diagnosis), demographic and weather data.

A careful analysis of the scheme was required to exclude a possible selection effect, for example due to differences in underlying morbidity levels between the districts covered by the scheme and those not covered. The authors used a difference-in-differences design to account for pre-existing trends and unobserved heterogeneity between the districts (adopters vs. non-adopters of the retrofits). They also exploited the time differences in retrofit adoption between the districts, and control for a wide range of socio-demographic characteristics, such as per capita income, racial mix, and school-staff-per-student ratio. However, their estimates had to rely on the assumption that the health trends of the adopters would have been the same as the non-adopters had they not implemented the programme.

Annual health care savings per district due to reduced inpatient episodes of bronchitis, asthma, pleurisy and pneumonia, following the adoption of filters on school buses were estimated between \$54,900 and \$128,100. The net present value of the programme was between \$424,000 and \$989,000 per district, without even accounting for long-term benefits from reductions in chronic sequelae and non-respiratory diseases.

An interesting feature of Beatty and Shimshack's study is that the authors did not have to estimate the impact of the programme on local air pollution levels in order to assess the health benefits of the intervention. They exploited a natural experiment offered by the fast introduction of the programme in order to estimate health impacts directly, with no knowledge or assumption on pollution levels.

Box 2 Establishing pollution thresholds based on a “Less-is-More” principle

Command-and-Control policies to reduce pollution levels often impose a technology standard, or an emission limit. The difficulties are that, not only the value limit needs to be established, but also the period of time over which the measurement applies. Optimal measures are not straightforward to establish as the government never has perfect information on the effects of different thresholds, and even less on wider societal impacts. In the case of pollution, a simple principle applies: the less, the better. In other words, there is no healthy level of pollution.

The above principle applies, for instance, to particulate matter (e.g. PM₁₀, PM_{2.5}), which represent a health hazard whether they are constant or observed in high concentrations over a short period of time.¹¹⁸ However, the approaches to particulate matter taken by regulators in different jurisdictions have been fairly heterogeneous. Not only the “US EPA National Ambient Air Quality Standards for PM_{2.5} are lower than the EU limit values” but also the “EU requirements for assessing compliance with the Limit Value for PM_{2.5} are not more stringent than the US EPA requirements for assessing compliance with the annual and 24-hour PM_{2.5} National Ambient Air Quality Standards”.¹¹⁹ p. 64²⁵ Compliance with particulate matter threshold values is challenging not only for the UK, but also for 24 other EU Member States.¹²⁰

Also the EU requirements have been found to be poorly aligned with current scientific evidence.¹¹⁸ In the case of particulates, they are roughly 2.5 times higher than the levels recommended by the WHO in 2005.¹²¹ Pollution in London is above WHO limits for particulate matter and NO₂. Levels of NO₂ exceed also EU thresholds and are not expected to fall below the latter until at least 2025.¹²¹ Environmental groups won two legal challenges against the UK government in 2017.¹²² There is now enough evidence to know that less is more and this principle should be applied consistently in government policy.

Box 3 Avoidance behaviour and self-selection

While there is no evidence of adaptation to pollution, there is some evidence of avoidance behaviour, that is people substituting their intended activities with different ones in order to reduce their exposure to pollution. Examples include the substitution of outdoor with indoor activities when air pollution levels are expected to be especially high, or moving more permanently to residential locations with lower pollution levels.

Smog alerts were found to significantly reduce attendance at outdoor facilities.¹⁰⁸ Bottled water purchases were found to increase by about 22% after public communications about tap water contamination levels exceeding safety thresholds.¹¹⁶ But responses to alerts are heterogeneous. In the United States, White and more educated mothers were found to respond more rapidly to information about toxic exposures for children, and were more likely to avoid those exposures.^{123,124,125}

Studies that do not account for the impact of avoidance behaviour on people's health are likely to underestimate the welfare costs of pollution.

References

- 1 J. Andreoni and A. Levinson, "The simple analytics of the environmental Kuznets curve," vol. 80, pp. 269–286, 2001.
- 2 S. Dinda, "Environmental Kuznets Curve Hypothesis : A Survey," vol. 49, pp. 431–455, 2004.
- 3 D. I. Stern, "The Rise and Fall of the Environmental Kuznets Curve," vol. 32, no. 8, pp. 1419–1439, 2004.
- 4 DEFRA (Department for Environment Food and Rural Affairs), "Defra's Climate Change Plan 2010," 2010.
- 5 P. J. Landrigan *et al.*, "The Lancet Commission on pollution and health," *Lancet*, vol. 6736, no. 17, 2017.
- 6 OECD, "The Economic Consequences of Outdoor Air Pollution," 2016.
- 7 Royal College of Physicians, "Every breath we take: the lifelong impact of air pollution," 2016.
- 8 DEFRA, "Impact pathway guidance for valuing changes in air quality," no. May, p. 23, 2013.
- 9 V. N. Likhvar *et al.*, "A multi-scale health impact assessment of air pollution over the 21st century," *Sci. Total Environ.*, vol. 514, pp. 439–449, 2015.
- 10 E. Boldo *et al.*, "Aphis: Health impact assessment of long-term exposure to PM_{2.5} in 23 European cities," *Eur. J. Epidemiol.*, vol. 21, no. 6, pp. 449–458, 2006.
- 11 S. E. Martenies, D. Wilkins, and S. A. Batterman, "Health impact metrics for air pollution management strategies," *Environ. Int.*, vol. 85, pp. 84–95, 2015.
- 12 D. Rojas-Rueda, A. de Nazelle, M. Tainio, and M. J. Nieuwenhuijsen, "The health risks and benefits of cycling in urban environments compared with car use: health impact assessment study," *BMJ*, vol. 343, p. d4521, 2011.
- 13 M. Mesa-Frias, Z. Chalabi, T. Vanni, and A. M. Foss, "Uncertainty in environmental health impact assessment: Quantitative methods and perspectives," *Int. J. Environ. Health Res.*, vol. 23, no. 1, pp. 1–15, 2012.
- 14 S. Medina, F. Ballester, O. Chanel, C. Declercq, and M. Pascal, "Quantifying the health impacts of outdoor air pollution: useful estimations for public health action," *J. Epidemiol. Community Health*, vol. 67, no. 6, pp. 480–483, 2013.
- 15 K. Y. Chay and M. Greenstone, "Does Air Quality Matter ? Evidence from the Housing Market," *J. Polit. Econ.*, vol. 113, no. 2, pp. 376–424, 2005.

- 16 M. Johannesson, "The willingness to pay for health changes, the human-capital approach and the external costs," *Health Policy (New York)*, vol. 36, no. 3, pp. 231–244, 1996.
- 17 P. J. Landrigan *et al.*, "The Lancet Commission on pollution and health," *Lancet*, vol. 6736, no. 17, 2017.
- 18 E. J. Mishan, "Introduction to Normative Economics," vol. 17, Oxford University Press Inc, 1981, pp. 18–19.
- 19 K. J. Arrow, "Uncertainty and the Welfare Economics of Medical Care," *Am. Econ. Rev.*, vol. 53, no. 5, pp. 941–973, 1963.
- 20 Global Green Growth Institute, "Extended Cost Benefit Analysis - Scoping Paper," no. October, pp. 1–17, 2014.
- 21 P. Bharadwaj, J. G. Zivin, J. T. Mullins, and M. Neidell, "Early-life exposure to the Great Smog of 1952 and the development of asthma," *Am. J. Respir. Crit. Care Med.*, vol. 194, no. 12, pp. 1475–1482, 2016.
- 22 J. Currie, S. Heep, and M. J. Neidell, "Quasi-Experimental Approaches to Evaluating the Impact of Air Pollution on Children's Health," *Health Aff.*, vol. 30, no. 12, pp. 2391–2399, 2011.
- 23 J. Sunyer *et al.*, "Association between Traffic-Related Air Pollution in Schools and Cognitive Development in Primary School Children: A Prospective Cohort Study," *PLOS Med. Med.*, vol. 12, no. 3, pp. 1–24, 2015.
- 24 J. Bierkens, J. Buekers, M. Van Holderbeke, and R. Torfs, "Health impact assessment and monetary valuation of IQ loss in pre-school children due to lead exposure through locally produced food," *Sci. Total Environ.*, vol. 414, pp. 90–97, 2012.
- 25 M. Greenstone, E. Kopits, and A. Wolverton, "Developing a social cost of carbon for us regulatory analysis: A methodology and interpretation," *Rev. Environ. Econ. Policy*, vol. 7, no. 1, pp. 23–46, 2013.
- 26 P. Watkiss, S. Pye, and M. Holland, "CAFE CBA: Baseline analysis 2000 to 2020," *AEA Technol. Environ.*, no. 5, 2005.
- 27 T. Xia, Y. Zhang, S. Crabb, and P. Shah, "Cobenefits of replacing car trips with alternative transportation: A review of evidence and methodological issues," *J. Environ. Public Health*, vol. 2013, no. 1, 2013.
- 28 H. T. Jensen *et al.*, "The importance of health co-benefits in macroeconomic assessments of UK Greenhouse Gas emission reduction strategies," *Clim. Change*, vol. 121, no. 2, pp. 223–237, 2013.
- 29 S. Leinert, H. Daly, B. Hyde, and B. Ó. Gallachóir, "Co-benefits? Not always: Quantifying the negative effect of a CO₂-reducing car taxation policy on NO_x emissions," *Energy Policy*, vol. 63, no. May 2012, pp. 1151–1159, 2013.

- 30 R. Ruttenberg, "Can protecting human health and the environment be justified on cost-benefit grounds?," *Ann. N. Y. Acad. Sci.*, vol. 837, pp. 456–461, 1997.
- 31 J. I. Levy, "Issues and uncertainties in estimating the health benefits of air pollution control.," *J. Toxicol. Environ. Health. A*, vol. 66, no. 16–19, pp. 1865–1871, 2003.
- 32 K. Kuklinska, L. Wolska, and J. Namiesnik, "Air quality policy in the U.S. and the EU – a review," *Atmos. Pollut. Res.*, vol. 6, no. 1, pp. 129–137, 2015.
- 33 COMEAP, *Long-Term Exposure to Air Pollution: Effect on Mortality*. 2009.
- 34 COMEAP, *Long-term Exposure to Air Pollution and Chronic Bronchitis*. 2016.
- 35 M. Holland, A. Hunt, F. Hurley, S. Navrud, and P. Watkiss, "Methodology for the Cost-Benefit analysis for CAFE: Volume 1: Overview of Methodology," *AEA Technol. Environ.*, vol. 1, no. 1, 2005.
- 36 F. Hurley *et al.*, "Methodology for the Cost-Benefit analysis for CAFE: Volume 2: Health Impact Assessment," *AEA Technol. Environ.*, vol. 2, no. 1, 2005.
- 37 M. Holland, F. Hurley, A. Hunt, and P. Watkiss, "Methodology for the Cost-Benefit Analysis for CAFE: Volume 3: Uncertainty in the CAFE CBA: Methods and First Analysis," *AEA Technol. Environ.*, vol. 3, no. 1, 2005.
- 38 Department for Environment Food and Rural Affairs, "Valuing impacts on air quality: Updates in valuing changes in emissions of Oxides of Nitrogen (NO_x) and concentrations of Nitrogen Dioxide (NO₂)," 2015.
- 39 R. Howard, S. Beevers, and D. Dajnak, "Up In the Air - How to Solve London 's Air Quality Crisis: Part 2," *Policy Exch.*, 2015.
- 40 J. V. Spadaro and A. Rabl, "Damage costs due to automotive air pollution and the influence of street canyons," *Atmos. Environ.*, vol. 35, no. 28, pp. 4763–4775, 2001.
- 41 M. Pascal *et al.*, "Assessing the public health impacts of urban air pollution in 25 European cities: Results of the Aphekom project," *Sci. Total Environ.*, vol. 449, pp. 390–400, 2013.
- 42 R. Howard, "Up In the Air - How to Solve London's Air Quality Crisis: Part I," *Policy Exch.*, 2015.
- 43 E. Alliance *et al.*, "What does coal cost health in the United Kingdom?," no. December, pp. 1–5, 2013.
- 44 M. Franchini, P. M. Mannucci, S. Harari, F. Pontoni, and E. Croci, "The Health and Economic Burden of Air Pollution," *Am. J. Med.*, vol. 128, no. 9, pp. 931–932, 2015.
- 45 J. Audet *et al.*, "Comparison of sampling methodologies for nutrient monitoring in streams: Uncertainties, costs and implications for

- mitigation,” *Hydrol. Earth Syst. Sci.*, vol. 18, no. 11, pp. 4721–4731, 2014.
- 46 V. H. Lascano-Alcoser, a G. J. Velthuis, H. J. van der Fels-Klerx, L. a P. Hoogenboom, and a G. J. M. Oude Lansink, “Optimizing bulk milk dioxin monitoring based on costs and effectiveness.,” *J. Dairy Sci.*, vol. 96, no. 7, pp. 4125–41, 2013.
- 47 D. Donaire-Gonzalez *et al.*, “Benefits of Mobile Phone Technology for Personal Environmental Monitoring,” *JMIR mHealth uHealth*, vol. 4, no. 4, p. e126, 2016.
- 48 A. L. S. Ward and T. K. M. Beatty, “Who Responds to Air Quality Alerts?,” *Environ. Resour. Econ.*, vol. 65, no. 2, pp. 487–511, 2016.
- 49 M. Neidell, “Air quality warnings and outdoor activities: evidence from Southern California using a regression discontinuity design.,” *J. Epidemiol. Community Health*, vol. 64, no. 10, pp. 921–926, 2010.
- 50 J. McLaren and I. D. Williams, “The impact of communicating information about air pollution events on public health,” *Sci. Total Environ.*, vol. 538, pp. 478–491, 2015.
- 51 J. Graff Zivin and M. Neidell, “Days of haze: Environmental information disclosure and intertemporal avoidance behavior,” *J. Environ. Econ. Manage.*, vol. 58, no. 2, pp. 119–128, 2009.
- 52 O. Hertel, M. Hvidberg, M. Ketzel, L. Storm, and L. Stausgaard, “A proper choice of route significantly reduces air pollution exposure - A study on bicycle and bus trips in urban streets,” *Sci. Total Environ.*, vol. 389, no. 1, pp. 58–70, 2008.
- 53 J. D. Marshall, M. Brauer, and L. D. Frank, “Healthy neighborhoods: Walkability and air pollution,” *Environ. Health Perspect.*, vol. 117, no. 11, pp. 1752–1759, 2009.
- 54 F. J. Kelly, G. W. Fuller, H. A. Walton, and J. C. Fussell, “Monitoring air pollution : Use of early warning systems for public health,” *Respirology*, vol. 17, pp. 7–19, 2012.
- 55 T. K. M. Beatty and J. P. Shimshack, “School buses, diesel emissions, and respiratory health,” *J. Health Econ.*, vol. 30, no. 5, pp. 987–999, 2011.
- 56 G. Stevens, A. Wilson, and J. K. Hammitt, “A benefit-cost analysis of retrofitting diesel vehicles with particulate filters in the Mexico City metropolitan area,” *Risk Anal.*, vol. 25, no. 4, pp. 883–899, 2005.
- 57 Z. M. Sultan, “Estimates of associated outdoor particulate matter health risk and costs reductions from alternative building, ventilation and filtration scenarios,” *Sci. Total Environ.*, vol. 377, no. 1, pp. 1–11, 2007.
- 58 M. S. Zuraimi and Z. Tan, “Impact of residential building regulations on reducing indoor exposures to outdoor PM 2.5 in Toronto,” *Build. Environ.*, vol. 89, pp. 336–344, 2015.

- 59 T. Katona, B. Kanyar, and J. Somlai, "Cost assessment of ventilation and averted dose due to radon in dwellings," *J. Environ. Radioact.*, vol. 79, no. 2, pp. 223–230, 2005.
- 60 D. J. Nowak, D. E. Crane, and J. C. Stevens, "Air pollution removal by urban trees and shrubs in the United States," *Urban For. Urban Green.*, vol. 4, no. 3–4, pp. 115–123, 2006.
- 61 Department for Communities and Local Government, "Study on the Provision of Carbon Monoxide Detectors Under The Building Regulations BD 2754," 2009.
- 62 A. Asikainen, P. Carrer, S. Kephelopoulos, E. de O. Fernandes, P. Wargocki, and O. Hänninen, "Reducing burden of disease from residential indoor air exposures in Europe (HEALTHVENT project).," *Environ. Health*, vol. 15 Suppl 1, no. Suppl 1, p. 35, 2016.
- 63 J. Gu, B. Mohit, and P. A. Muennig, "The cost-effectiveness of bike lanes in New York City," *Inj. Prev.*, p. injuryprev-2016-042057, 2016.
- 64 M. Tainio *et al.*, "Can air pollution negate the health benefits of cycling and walking?," *Prev. Med. (Baltim).*, vol. 87, pp. 233–236, 2015.
- 65 A. de Nazelle, O. Bode, and J. P. Orjuela, "Comparison of air pollution exposures in active vs. passive travel modes in European cities: A quantitative review," *Environ. Int.*, vol. 99, pp. 151–160, 2017.
- 66 M. Moodie, M. Haby, L. Galvin, B. Swinburn, and R. Carter, "Cost-effectiveness of active transport for primary school children - Walking School Bus program.," *Int. J. Behav. Nutr. Phys. Act.*, vol. 6, p. 63, 2009.
- 67 N. Mueller *et al.*, "Health impact assessment of active transportation: A systematic review," *Prev. Med. (Baltim).*, vol. 76, pp. 103–114, 2015.
- 68 A. Goodman, S. Sahlqvist, and D. Ogilvie, "New walking and cycling routes and increased physical activity: One- and 2-year findings from the UK iConnect study," *Am. J. Public Health*, vol. 104, no. 9, pp. 38–46, 2014.
- 69 OECD, "Voluntary Approaches for Environmental Policy - Effectiveness, Efficiency, and Usage in Policy Mixes," 2003.
- 70 K. Brouhle, C. Griffiths, and A. Wolverton, *The Handbook of Environmental Voluntary Agreements - Chap. The Use of Voluntary Approaches for Environmental Policymaking in the U.S.* Springer, Dordrecht, 2005.
- 71 B. C. Field and M. K. Field, *Environmental Economics: An Introduction*, 7th ed. The McGraw-Hill Companies, 2017.
- 72 V. Fensterer *et al.*, "Evaluation of the impact of low emission zone and heavy traffic ban in Munich (Germany) on the reduction of PM10 in ambient air," *Int. J. Environ. Res. Public Health*, vol. 11, no. 5, pp. 5094–5112, 2014.

- 73 L. V. Giles *et al.*, “From good intentions to proven interventions: Effectiveness of actions to reduce the health impacts of air pollution,” *Environ. Health Perspect.*, vol. 119, no. 1, pp. 29–36, 2011.
- 74 World Health Organization, “Review of evidence on health aspects of air pollution – REVIHAAP Project,” *World Heal. Organ.*, p. 309, 2013.
- 75 J. Lomas *et al.*, “A pharmacoeconomic approach to assessing the costs and benefits of air quality interventions that improve health: a case study,” *BMJ Open*, vol. 6, no. 6, p. e010686, 2016.
- 76 C. Tonne, S. Beevers, B. Armstrong, F. Kelly, and P. Wilkinson, “Air pollution and mortality benefits of the London Congestion Charge: spatial and socioeconomic inequalities,” *Occup. Environ. Med.*, vol. 65, no. 9, pp. 620–7, 2008.
- 77 DEFRA, “An Economic Analysis to Inform the Air Quality Strategy - Updated Third Report of the International Group on Costs and Benefits,” vol. 3, 2007.
- 78 A. Hunt, “Policy Interventions to Address Health Impacts Associated with Air Pollution, Unsafe Water Supply and Sanitation, and Hazardous Chemicals,” no. 35, p. 75, 2011.
- 79 C. Johansson, L. Burman, and B. Forsberg, “The effects of congestions tax on air quality and health,” *Atmos. Environ.*, vol. 43, no. 31, pp. 4843–4854, 2009.
- 80 J. Eliasson, “A cost-benefit analysis of the Stockholm congestion charging system,” *Transp. Res. Part A Policy Pract.*, vol. 43, no. 4, pp. 468–480, 2009.
- 81 R. N. Stavins, “‘Market-Based Environmental Policies.’ In *Public Policies for Environmental Protection*, edited by Paul R Portney and RN Stavins. 2nd ed. Washington, D.C.: Resources for the Future,” 2000.
- 82 M. Greenstone, “Did the Clean Air Act cause the remarkable decline in sulfur dioxide concentrations ?,” vol. 47, pp. 585–611, 2004.
- 83 L. G. Chestnut and D. M. Mills, “A fresh look at the benefits and costs of the US acid rain program,” *J. Environ. Manage.*, vol. 77, no. 3, pp. 252–266, 2005.
- 84 J. J. Winebrake, A. E. Farrell, and M. A. Bernstsein, “The Clean Air Act’s sulfur dioxide emissions market: Estimating the costs of regulatory and legislative intervention,” *Resource and Energy Economics* vol. 17, pp. 239–260, 1995.
- 85 D. D. Parrish, J. Xu, B. Croes, and M. Shao, “Air quality improvement in Los Angeles—perspectives for developing cities,” *Front. Environ. Sci. Eng.*, vol. 10, no. 5, 2016.
- 86 J. M. Samet, T. A. Burke, and B. D. Goldstein, “The Trump Administration and the Environment - Heed the Science,” *N. Engl. J. Med.*, vol. 376, no. 12, 2017.
- 87 K. Y. Chay and M. Greenstone, “Air Quality, Infant Mortality, and the Clean Air Act of 1970,” *NBER Work. Pap. Ser.*, vol. 10053, 2003.

- 88 K. Chay, C. Dobkin, and M. Greenstone, "The Clean Air Act of 1970 and Adult Mortality," *J. Risk Uncertain.*, vol. 27, no. 3, pp. 279–300, 2003.
- 89 A. Patt, "Separating Analysis From Politics: Acid Rain In Europe," *Policy Stud. Rev.*, vol. 16, no. 3:4, pp. 104–137, 1999.
- 90 F. C. Menz and H. M. Seip, "Acid rain in Europe and the United States: An update," *Environ. Sci. Policy*, vol. 7, no. 4, pp. 253–265, 2004.
- 91 S. Luechinger, "Air pollution and infant mortality : A natural experiment from power," *J. Health Econ.*, vol. 37, pp. 219–231, 2014.
- 92 D. Fowler, N. Dise, and L. Sheppard, "Committee on air pollution effects research: 40 years of UK air pollution," *Environ. Pollut.*, vol. 208, pp. 876–878, 2016.
- 93 J. Mason and M. J. Brown, "Estimates of costs for housing-related interventions to prevent specific illnesses and deaths," *J. Public Heal. Manag. Pract.*, vol. 16, no. 5 Suppl, pp. S79-89, 2010.
- 94 M. P. Fabian, G. Adamkiewicz, N. K. Stout, and J. I. Levy, "A simulation model of building intervention impacts on indoor environmental quality, pediatric asthma, and costs," *J. Allergy Clin. Immunol.*, vol. 133, no. 1, pp. 1–18, 2015.
- 95 A. R. Denman, P. S. Phillips, R. Tornberg, and C. J. Groves-Kirkby, "Analysis of the individual health benefits accruing from a domestic radon remediation programme," *J. Environ. Radioact.*, vol. 79, no. 1, pp. 7–23, 2005.
- 96 D. R. McCubbin, B. J. Apelberg, S. Roe, and F. Divita, "Livestock ammonia management and particulate-related health benefits," *Environ. Sci. Technol.*, vol. 36, no. 6, pp. 1141–1146, 2002.
- 97 S. Schucht *et al.*, "Moving towards ambitious climate policies: Monetised health benefits from improved air quality could offset mitigation costs in Europe," *Environ. Sci. Policy*, vol. 50, pp. 252–269, 2015.
- 98 T. Grigoratos and G. Martini, "Non-exhaust traffic related emissions. Brake and tyre wear PM - Literature review," *Sci. Policy Rep. by Jt. Res. Centre, Eur. Comm. in-house Sci. Serv.*, 2014.
- 99 V. R. J. H. Timmers and P. A. J. Achten, "Non-exhaust PM emissions from electric vehicles," *Atmos. Environ.*, vol. 134, pp. 10–17, 2016.
- 100 A. Markandya and P. Wilkinson, "Electricity generation and health," *Lancet*, vol. 370, no. 9591, pp. 979–990, 2007.
- 101 B. S. P. Holland, E. T. Mansur, N. Z. Muller, and A. J. Yates, "Are There Environmental Benefits from Driving Electric Vehicles ? The Importance of Local Factors †," vol. 106, no. 12, pp. 3700–3729, 2016.
- 102 D. Carrington, "Electric cars are not the answer to air pollution, says top UK adviser," *The Guardian*.

- 103 E. Gould, "Childhood lead poisoning: Conservative estimates of the social and economic benefits of lead hazard control," *Environ. Health Perspect.*, vol. 117, no. 7, pp. 1162–1167, 2009.
- 104 D. Gregory, O. Mclaughlin, S. Mullender, and N. Sundararajah, "New solutions to air pollution challenges in the UK," *London Forum Sci. Policy Brief. Pap.*, no. April, 2016.
- 105 R. Aldred and K. Jungnickel, "Why culture matters for transport policy: The case of cycling in the UK," *J. Transp. Geogr.*, vol. 34, pp. 78–87, 2014.
- 106 J. Currie and M. Neidell, "Air Pollution and Infant Health: What Can We Learn From California's Recent Experience?," *Q. J. Econ.*, vol. 120, no. 3, pp. 1003–1030, 2005.
- 107 C. Brink, E. van Ierland, L. Hordijk, and C. Kroeze, "Cost-effective emission abatement in europe considering interrelations in agriculture.," *ScientificWorldJournal.*, vol. 1 Suppl 2, pp. 814–21, 2001.
- 108 M. Neidell, "Information , Avoidance Behavior , and Health : The Effect of Ozone on Asthma Hospitalizations," *J. Hum. Resour.*, vol. 44, no. 2, pp. 450–478, 2009.
- 109 M. J. Neidell, "Air pollution, health, and socio-economic status: The effect of outdoor air quality on childhood asthma," *J. Health Econ.*, vol. 23, no. 6, pp. 1209–1236, 2004.
- 110 E. Moretti and M. Neidell, "Pollution, Health, and Avoidance Behavior: Evidence from the Ports of Los Angeles," *J. Hum. Resour.*, vol. 46, no. July 2014, pp. 154–175, 2011.
- 111 L. Heinzerling and F. Ackerman, "Pricing the Priceless: Cost-Benefit Analysis of Environmental Protection," *Univ. PA. Law Rev.*, vol. 150, pp. 1553–1584, 2002.
- 112 D. Baldock, A. Farmer, and M. Nesbit, "Brexit – the Implications for UK Environmental Policy and Regulation," *All-Party Parliam. Environment Gr.*, no. March, pp. 1–15, 2016.
- 113 I. Kilbande-Dawe, "14 Cost Effective Actions to Cut Central London Air Pollution," 2012.
- 114 P. Kumar *et al.*, "The rise of low-cost sensing for managing air pollution in cities," *Environ. Int.*, vol. 75, pp. 199–205, 2015.
- 115 V. Sivaraman, J. Carrapetta, K. Hu, and B. G. Luxan, "HazeWatch: A participatory sensor system for monitoring air pollution in Sydney," *Proc. - Conf. Local Comput. Networks, LCN*, pp. 56–64, 2013.
- 116 L. Trasande and Z. Brown, *Promoting Health, Preventing Disease - The Economic Case, Chapter 8 "Addressing Environmental Risks for Child Health,"* vol. 23, no. 3. 2015.
- 117 P. Monahan, "School Bus Pollution Report Card 2006 - Grading the States," *Union Concerned Sci.*, 2006.

- 118 I. Annesi-Maesano, F. Forastiere, N. Kunzli, and B. Brunekref, "Particulate matter, science and EU policy," *Eur. Respir. J.*, vol. 29, no. 3, pp. 428–431, 2007.
- 119 B. Brunekreef and R. L. Maynard, "A note on the 2008 EU standards for particulate matter," *Atmos. Environ.*, vol. 42, pp. 6425–6430, 2008.
- 120 M. Gemmer and X. Bo, "Air Quality Legislation and Standards in the European Union : Background , Status and Public Participation," *Adv. Clim. Chang. Res.*, vol. 4, no. 1, pp. 50–59, 2013.
- 121 H. Quilter-pinner and L. Laybourn-langton, "Lethal and illegal: London's air pollution crisis," *IPPR*, no. July, 2016.
- 122 D. Carrington, "UK government sued for third time over illegal air pollution from diesels," vol. 10.
- 123 B. Joshua, G. Zivin, M. Neidell, and W. Schlenker, "Water Quality Violations and Avoidance Behavior : Evidence from Bottled Water Consumption," pp. 448–453, 2011.
- 124 J. Currie, J. G. Zivin, K. Meckel, M. Neidell, and W. Schlenker, "Something in the water: contaminated drinking water and infant health.," *Can. J. Econ.*, vol. 46, no. 3, pp. 791–810, 2013.
- 125 J. Currie, "Pollution and Infant Health," *Child Dev. Perspect.*, vol. 7, no. 4, pp. 232–242, 2013.

Chapter 06

Pollution and inequality

Chapter lead

Professor Gordon Walker¹

Chapter authors

Professor Gordon Walker¹, Professor Rich Mitchell²

1 Department of Geography and Lancaster Environment Centre, Lancaster University

2 Professor Social and Public Health Sciences, University of Glasgow

Summary

- Pollution is unequally distributed and contributes to health inequalities.
- Pollution-related health inequalities exist for various reasons. Pollution sources can be concentrated in particular areas, once in the environment pollution may accumulate and disperse unevenly, and some people can be more susceptible to the health effects of being exposed to pollution than others.
- There are strong geographical differences in the occurrence and concentration of pollutants. Analysis shows that these patterns, which vary by pollutant type, are related to measures of socioeconomic status, with pollution sources and higher concentrations of ambient pollution typically found in more socially disadvantaged areas.
- The evidence of how pollution sources and concentrations vary with other socio-demographic variables, including ethnicity, is less substantial and consistent. How unequal patterns of pollution exposure relate to health inequalities is complex. Poor health status, adverse health behaviours, multiple environmental exposures and psychosocial stress are more prevalent in lower socioeconomic groups. These factors may mean that pollution exposure has greater impacts on the health of these groups, a so-called 'triple jeopardy' effect.
- These relationships have been most substantially examined for air quality. UK studies provide tentative evidence of differences in susceptibility affecting health outcomes from air pollution exposure. International studies are more conclusive that these effects exist.
- Options to intervene in the relationship between pollution and health inequalities include proactive assessment of the distributional effects of plans and policies to inform decision-making; targeting measures on 'pollution-poverty hotspots'; and supporting community involvement in pollution monitoring and mitigation.

Background

Addressing health inequalities is a long-standing priority of the UK government¹, with specific duties on the Secretary of State for Health and health care providers laid out under the Health and Social Care Act 2012. Not only are health inequalities, as the Marmot report stated, “*a matter of life and death, of health and sickness, of well-being and misery*”², but they are also a significant detriment to realising employment and other life-opportunities, with consequences that ‘spill-over’ for all of society, including increased healthcare and welfare expenditure.³ In England, health and well-being indicators repeatedly reveal significant differences between population groups in socio-economic and other terms, such that life expectancy, serious illness and many other detriments to wellbeing are distributed regressively along social gradients.^{2 p.10} Across local authorities in England there are large inequities in life expectancy at birth. It is highest in Kensington and Chelsea for boys (83.3 years) and Chiltern for girls (86.7 years), compared with Blackpool for boys (74.7 years) and Middlesbrough for girls (79.8 years).⁴ The social gradient in health in England has also worsened significantly over the past 30 years.

Health inequalities are defined by Public Health England as ‘*systematic, avoidable and unjust differences in health and wellbeing between different groups of people*’.^{5 p. 41} The impact of pollution on health, the concern of this chapter, has the potential to be differentiated between groups of people in *systematic, avoidable* and *unjust* ways, exacerbating underlying inequalities in a number of harmful non-communicable diseases.

While there are complexities involved in making definitive assessments of the patterns and consequences of pollution inequalities, evidence indicates that poorer and disadvantaged groups in society are often systematically exposed to higher levels of pollution and that they may be more susceptible to the impacts of that pollution. Differences in pollution impacts on health can therefore be both a *cause* of health inequalities and a *consequence* of them, and in both respects argued to be both avoidable and unjust. To further compound patterns of injustice, evidence from ‘polluter pays’ analyses show that those most at risk of health impacts from pollution are typically far less involved in its production⁶⁻⁸: least responsible, but potentially most at harm. The notion of *environmental justice* is widely used to capture these concerns^{9,10} (see Box 1).

Box 1 Environmental Justice

In the US in particular, environmental justice has become the focus of a substantial body of activism, research and policy activity. Over the past 30 years, attention has been given to differences in pollution burdens between population groups defined in racial, socio-economic and other terms.¹⁰⁻¹² Activists argue that various forms of environmental discrimination exist which need to be addressed by regulatory bodies such as the US Environmental Protection Agency, and government policy has since 1994 made environmental justice part of the mission of all Federal agencies. In the UK there is a less established environmental justice agenda, although the research base is developing and both non-government organisations¹³⁻¹⁵ and different parts of government¹⁶⁻¹⁹ have made some steps towards investigating the relationship between environmental and health inequalities. Air pollution has been the primary focus, but by no means the only one.²⁰⁻²² Whilst most attention is typically given to the distribution of exposure and impacts between different groups in current populations, questions of intergenerational justice can extend to consequences for future generations.

In this chapter we summarise and evaluate key aspects of the existing evidence base. Our focus is first on inequalities in patterns of pollution distribution, concentrating in particular on the geographical relationships between pollution sources and levels and patterns of poverty or social deprivation. We then focus on air pollution, the subject of most of the existing work, to examine evidence of 'effect modification' – how for a given level of pollution exposure more deprived and vulnerable population groups can suffer stronger health effects than others.

Relating pollution and health inequalities

Establishing the nature and detail of relationships between pollution and health inequalities is difficult. At each stage of the 'source-pathway-receptor' sequence there can be important differentiations to consider (Figure 6.1). *Sources* of pollution are often concentrated in particular geographic areas – due to, for example, the density of traffic or co-location of multiple industrial sources. Once released, the *pathways* that pollutants follow in the environment can mean that they remain or become concentrated in particular places, and/or at particular times. The presence of people, as *receptors*, in those places can then be differentiated in various ways, in terms of their demographic and social characteristics, their patterns of activity over time and space, and their susceptibility to harm from the pollutants they are exposed to.

There are interactions between multiple pollutants both in a place and in peoples' bodies, which can have potential accumulative and synergistic effects.²³ There can also be synergies between social vulnerabilities, for example greater vulnerabilities from being both elderly *and* socially disadvantaged. It is therefore hard to accurately measure effects, and further developments in knowledge and analytical tools are necessary.

Table 6.1 conveys the scope of UK environmental inequality research to date, indicating the analytical approach adopted with, on the left, a focus on socio-environmental relationships from which impacts on health are inferred, and on the right, approaches which explicitly attempt to quantify associated health consequences. The coverage is patchy, even though the UK arguably has one of the better evidence bases on environmental inequality. The majority of studies fall to the left of the table, illustrating how environmental inequalities and health inequalities research have largely been pursued as separate disciplines.

Figure 6.1 Summary of potential for health inequality across the pollutant source-pathway-receptor model

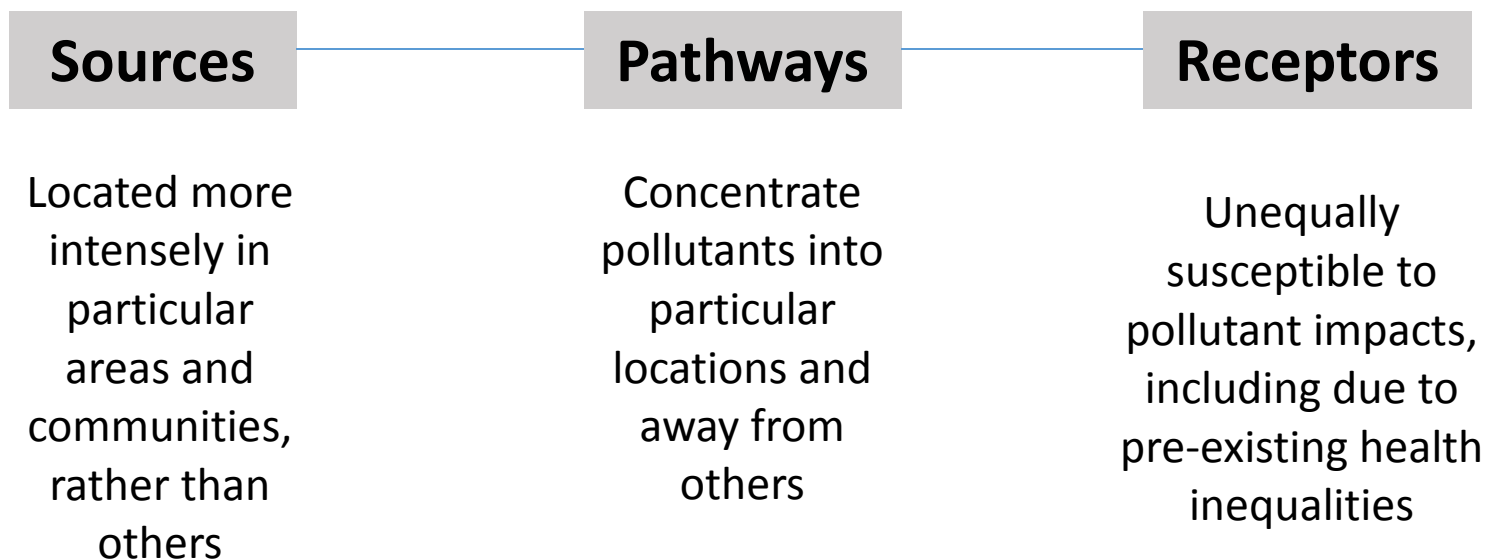

Source Professor Gordon Walker, Lancaster University

Table 6.1 Overview of UK environmental inequalities research by issue and approach, extending beyond pollution

Analytical approach	Proximity	Emission	Area level Concentration /intensity	Concentration or dose experienced by individuals	Health response
Feature of analytical approach	<i>Good data availability</i>				<i>Little data</i>
	<i>Relatively cheap</i>				<i>Relatively expensive</i>
Environment metric	<i>Whole populations</i>				<i>Small samples</i>
	<i>Health effects inferred</i>				<i>Health effects observed</i>
Industrial hazards (IPC sites)	✓✓✓				
Landfill sites	✓✓✓				
Air quality (NO _x , fine particulates)		✓✓	✓✓✓	✓	✓
Surface water quality	✓				
Potable water quality	✓				
Noise			✓		
Radon	✓				
Electro-magnetic radiation	✓				
Flood hazard	✓✓				
Woodland‡	✓				
Parks /other green space‡	✓✓				
'Blue space'*‡	✓				
Multiple /cumulative			✓✓		✓

✓✓✓ - Most research, ✓ At least one study

* Health-enabling spaces where water is at the centre

‡ Hypothesis that deprived groups have least access to health enabler

Inequalities in patterns of pollution

The evidence base specifically on pollution inequality has been developed through analysis of pre-existing spatially disaggregated environmental data against social variables, predominantly using various measures of poverty, deprivation and socioeconomic status.

Air quality

The most robust evidence relates to air quality. Concentrations of nitrogen oxides (NO_x) and fine particulates (PM₁₀) display a strong social gradient. For mean annual concentration, a U-shaped distribution (Figure 6.2a) has been repeatedly found across various studies, as lowest concentrations tend to be in more rural areas of medium deprivation.^{7,8,19,24}

Considering only locations where concentration values exceed the national air quality standard annual average limit values, the U shaped distribution disappears, and a very strong gradient is evident (Figure 6.2b). In 2001, of the 2.5 million people resident in areas where the annual mean NO₂ limit value was exceeded, over half were in the poorest 20% of the population; by 2011 the exceedance population had fallen to 0.6 million due to overall improvements in air quality, but 85% of this population was in the poorest fifth²⁵ (Figure 6.3). Studies elsewhere in Europe have varied in geographic extent, spatial unit, social metric, atmospheric pollutant, and analytical method, yet broadly confirm that the most deprived populations experience higher and more health-threatening environmental exposures.^{26,27}

Figure 6.2a Social distribution of annual average NO₂ concentration in England, 2001

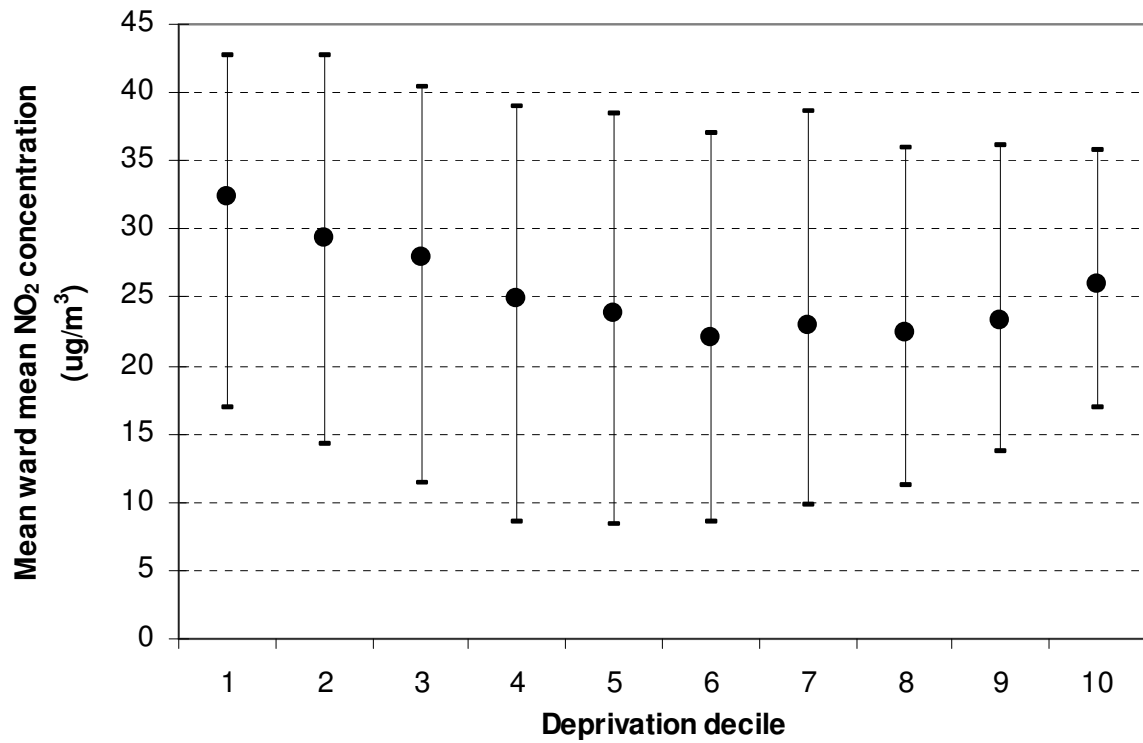

Note

- i Bars denote 5-95 percentile range, N=8,414.
- ii Each decile represents the average of electoral ward mean NO₂, measured as an annual mean.

Source Walker G et al. Environmental Quality and Social Deprivation. Phase II: National Analysis of Flood Hazard, IPC Industries and Air Quality. The Environment Agency (2003)

Figure 6.2b

Population resident in areas exceeding the annual average legal limit value for NO₂, by deprivation decile, England 2001

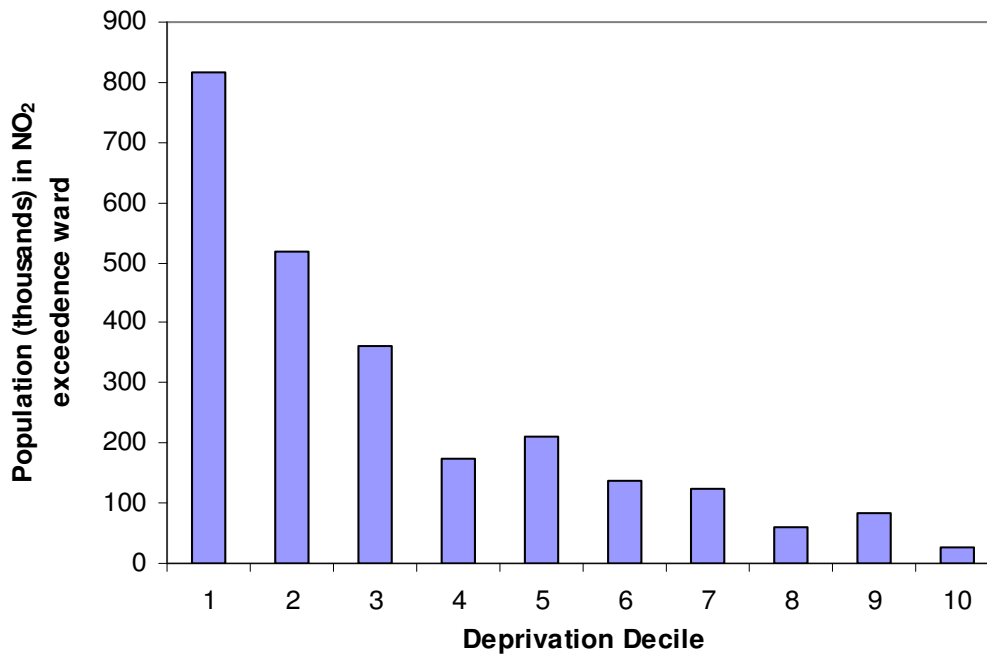

Notes

- i Annual mean standard is 40 ug/m³, applied as a ward average.
- ii Decile 1 is most deprived. All deciles have 4.9 million people.
- iii 2.51 million people are in an NO₂ exceedance ward, 5.1% of the population of England.
- iv 53% of all person exceedances are in the most deprived quantile.

Source Walker G et al. Environmental Quality and Social Deprivation. Phase II: National Analysis of Flood Hazard, IPC Industries and Air Quality. The Environment Agency (2003)

Figure 6.3 Great Britain population in lower super output areas (LSOAs) where NO₂ exceeds the 40 µg m³ annual average legal limit value

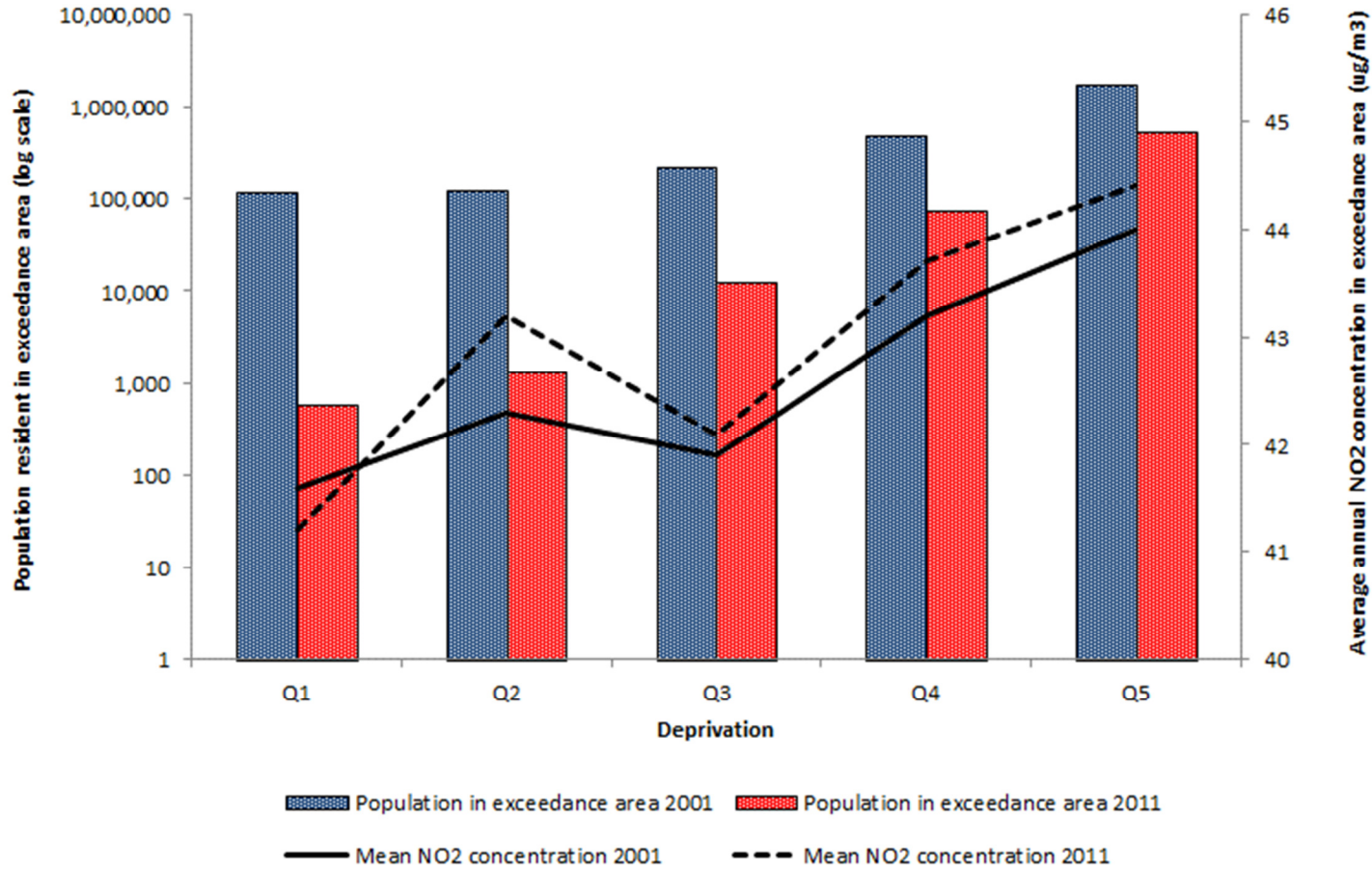

Note

Q1 is the least deprived fifth, Q5 the most deprived fifth. Concentration values are the mean of annual average concentrations for LSOAs where NO₂ concentration >40 µg m³. NB. log-scale (25)

Ethnic minority populations in the UK are also exposed to higher concentrations of NO₂ and PM₁₀ but there is no indication whether this is a casual link with ethnicity or a facet of the socioeconomic status of ethnic minority groups; nor is there consensus on the link between ethnic susceptibility to air pollution and health.^{28,29} However, fetuses, babies and children are known to be more susceptible to poor air quality³⁰ and increased exposure of children in UK national small area analyses has been observed for NO₂^{7,29} but not fine particulates.²⁹ Gender has been little studied with respect to the social distribution of pollution³¹, but can be expected to become more prominent as environmental inequality analyses begin to consider an individualistic perspective better able to account for temporal variability in exposure, for example due to differences in daily travel patterns.⁶

Indoor air quality has been less studied, but research in the US shows a positive association between deprivation and poor indoor air quality (NO₂, fine particulates, VOCs, lead, allergens). Indoor air quality is determined by outdoor air quality, indoor pollutant sources and occupant activity, and physical features of housing.³² No comparable equity research exists for the UK, but it is reasonable to assume a similar association, given the strong association of deprivation with outdoor air pollution, and smaller, often lower quality housing.

Other pollutants and risks

For other environmental pollutants and risks (Table 6.1) evidence exists of a strong association (for England) between deprivation and proximity to activities regulated under Industrial Pollution Prevention and Control (IPPC) legislation, including major industrial and petrochemical sites and waste incinerators.³³ Site specific studies are equivocal in terms of associated health impacts, whilst at a national level health impacts are analysed within the wider context of air quality (see below), for which road traffic is the dominant source. Landfill sites are geographically associated with deprivation^{18,34}, although study results are dependent on methodological choices³⁵ and not clearly associated with elevated health risk.³⁶ In England, exposure to brownfield land is higher in the north and is associated with spatial inequalities in mortality and morbidity both within English regions, and between them, although differential brownfield exposure does not appear to contribute to the north-south health divide, probably due to differences in the distribution of types of brownfield land.³⁷

An analysis of ambient noise emission levels from road and rail traffic in Birmingham found a weak relationship with deprivation³⁸ but no other UK noise studies exist. A systematic international review of noise health effects, focused on vulnerable groups, concluded that differentials in both physiological and psychological effects were largely anecdotal, with subgroup-specific exposure-effect studies needed.³⁹ There are various newer forms of health threats from pollution (see Chapter 4 of this report, 'New horizons') where questions of inequality are yet to be examined.

Multiple environmental hazards

Environmental inequalities research has also sought to understand the social distribution of environmental metrics in combination. National and region-specific analyses show that with increasing area deprivation there is a greater likelihood of populations being exposed to multiple environmental hazards, in terms of both the intensity of a specific hazard (such as the clustering of industrial or waste facilities), and local exposure to a multiplicity of hazard types (such as the coincidence of industrial hazards, poor air quality and flood risk).^{19,40-42}

Environmental inequalities over time

Tracing how environmental inequalities develop over time is an important step in understanding how they have arisen, but such studies tend to be constrained by a lack of small area longitudinal data. However, an analysis of air quality change in Britain from 2001-2011 reveals a social gradient in environmental change.²⁵ Where air quality has improved (falling NO₂) it does so most quickly in the least deprived areas, and where it has worsened (rising PM₁₀) it does so more quickly in the most deprived areas. This may be a consequence of the more polluted initial conditions experienced by the more deprived communities (for example greater air quality improvement is needed to attain 'good' air quality than in the less polluted, more affluent areas). Overall improvements in air quality should have reduced the associated national disease burden, but the social gradient (Figure 6.3) implies social inequality in how this benefit is distributed.²⁵ This suggests that interventions that reduce pollution overall can deliver health gains, but if intended to reduce health inequalities, they require more targeted interventions (discussed further below).

Evidence linking air pollution to health inequalities

As outlined earlier, the relationship between pollution and health inequalities is not just that pollution exposure is distributed unevenly between population groups. The second mechanism that can act independently or concurrently is that of *differential susceptibility*, in which for the same level of pollution, more socially disadvantaged groups – and others in the population – can be more vulnerable to exposure than high ones. Factors such as poor health status (for example COPD, asthma and existing CVD), adverse health behaviours (for example smoking and diet), multiple environmental exposures (for example occupational) and psychosocial stress are more prevalent in lower socioeconomic status groups and may act in addition or synergy (that is, as effect modifiers) with pollution exposure.

The ‘triple jeopardy’ for disadvantaged groups of first, higher exposure to air pollution, and second a greater burden of poor health, may then be further added to by a third effect arising from greater susceptibility to the impact of pollution.⁴³ These processes have been most investigated in relation to air pollution, and are the focus of this section. Existing evidence is reviewed, being careful to exclude studies that do not formally test differences in susceptibility between socioeconomic groups. Studies in many countries have considered the role of short- and long-term pollution exposure in explaining socioeconomic gradients in health outcomes with a plausible aetiological pollution link. Health outcomes considered include all-cause and cause-specific mortality, respiratory health (for example asthma), birth weight, and hospital admissions due to a respiratory condition.

International evidence

Recent global and European studies reviewing the evidence that socioeconomic status (SES) modifies the effect of air pollution on health, broadly suggest that irrespective of differences in exposure, lower SES populations experience the greater effects of air pollution. The evidence base is particularly strong (number of studies and quality of study design) in the United States with a handful of studies in other, mostly European, countries.

A systematic review of the international literature found lower SES groups were at higher risk of death due to short-term exposure to particulate matter (PM₁₀ and PM_{2.5}).⁴⁴ Similarly a review of the literature on differential effects of ozone-health relations by SES noted evidence of associations between ozone exposure and mortality for some (for example unemployment and lower occupational status) but not all (for example low education and poverty) lower SES groups.⁴⁵ Other studies review the evidence relating to particular 'vulnerable' groups. For example, an international review found lower socioeconomic status pregnant women are more vulnerable to air pollution with an increased risk of having a child with low birth weight at term.⁴⁶ On the other hand, another review found limited evidence that the association between air pollution and children's asthma exacerbations varied between SES groups.⁴⁷

UK evidence

Whilst, as already summarised, there is a significant body of work in the UK documenting socioeconomic inequalities in air pollution exposure, few studies have examined whether there is a synergistic relationship between SES and air pollution that acts to affect health. To date there have been six UK studies explicitly addressing this question, another using a composite environmental index as the exposure metric (including measures of air pollution), and a further Europe-wide study that includes UK data (Table 6.2).

Table 6.2 Socioeconomic inequalities in air pollution exposure - Europe-wide studies including UK data

Authors and year of publication	Pollutant(s)	SES indicators	Geographical unit	Location	Population	Findings
Wheeler & Ben-Shloma (2005) ⁴⁸	NO ₂ , SO ₂ , benzene, PM ₁₀	Household social class	1991 census wards	England	Participants aged 16–79 in the Health Survey for England 1995, 1996, 1997	Differential effect of air pollution on lung function for males only; effect in social classes III to V double that in social classes I & II.
Briggs et al (2008) ⁴³	Road traffic, industry, electro-magnetic frequency radiation, disinfection by-products in drinking water & radon	Index of Multiple Deprivation (& constituent domains)	3 levels of analysis: super output areas, census wards & districts	England	Full population	Some evidence of greater risk of poorer general health for those living in more socially disadvantaged areas
Pearce et al (2010) ⁴²	Composite 'Multiple Environmental Deprivation Index' including of PM ₁₀ , NO ₂ , SO ₂ , and CO, plus greenspace	Area-level income deprivation	10,654 Census Area Statistics Wards	UK-wide	Full population	Influence of multiple environmental deprivation on health greater in the <i>least</i> income-deprived areas
Jephcote & Chen (2012) ⁴⁹	PM ₁₀ road-transport emissions	Area-level measure of social deprivation (Carstairs Index), ethnicity	187 Lower Level Super Output Areas	Leicester	Children aged 0–15	Double-burden of road transport emissions and social deprivation related to children's respiratory health.

Authors and year of publication	Pollutant(s)	SES indicators	Geographical unit	Location	Population	Findings
Richardson et al (2013) ⁵⁰	PM ₁₀	Mean household income	268 sub-national regions (NUTS level)	Europe-wide	Full population	Lower income regions more susceptible to health effects. Restricted to circulatory disease mortality in Eastern Europe and male respiratory mortality in Western Europe
Halonen et al (2016) ⁵¹	Traffic pollution including NO _x , NO ₂ , tailpipe emissions, PM _{2.5} and PM ₁₀	Area-level measure of social deprivation (Carstairs Index), ethnicity	27,686 Census Output Areas	Greater London	Full population	Higher risk of emergency hospital admissions for cardio-respiratory diseases among those living in areas with the highest socioeconomic deprivation
Brunt et al (2016) ⁵²	Ambient NO ₂ , PM ₁₀ , PM _{2.5} concentrations	Area-level measure of income-deprivation	1909 Lower-layer Super Output Areas	Wales	Full population	Interactions between air pollution and deprivation strengthened associations with all-cause and respiratory disease
Milojevic et al (2017) ⁵³	Ozone and particulate matter (sub-divided into PM ₁₀ , PM _{2.5} , PM _{2.5-10} , primary, nitrate and sulphate PM _{2.5})	Area-level income & employment domains of the Index of Multiple Deprivation	1,202,578 residential postcodes in	England	Full population	PM _{2.5} pollution made a modest contribution to socioeconomic gradient attributable life years lost.

The UK work has covered a variety of different pollutants, sources (ambient, traffic, industrial), measures of SES (both individual and area-level indicators), populations (adults, children) and health outcomes. There has been no relevant UK work on indoor pollution.

Studies of overall and cause-specific mortality, life years lost, and hospital admissions point to an increased health risk of pollution exposure amongst those living in disadvantageous social circumstances. For example, a study in London of annual concentrations of a range of traffic pollutants, and emergency hospital admissions for cardio-respiratory outcomes found some evidence of increased risk amongst those living in more socially disadvantaged neighbourhoods.⁵¹ Similar findings have been noted in Leicester for hospitalisations amongst children⁴⁹, all-cause and respiratory disease mortality in Wales⁵², and general health⁴³ and life years lost across England⁵³, although in all cases the evidence was mixed or suggested modest effects.

A UK wide study of 'multiple environmental deprivation' (a composite index of various health-related features of the environment including measures of PM₁₀, NO₂, SO₂, and CO) found that whilst more socially disadvantaged populations were exposed to higher levels of multiple environmental deprivation, the influence of multiple environmental deprivation on health was most pronounced in the *least* income-deprived areas.⁴² Therefore contrary to the findings of most other work in the UK, the physical environment did not exert a disproportionately detrimental effect on the health of the most socially disadvantaged groups, although given the small number of areas with high levels of social disadvantage and 'high quality' environments this finding should be treated with caution.

Finally, a Europe-wide analysis (including the UK) of 268 subnational regions found that lower income regions had higher average pollution (PM₁₀) concentrations and that populations of these regions were more susceptible to pollution, although any effect seemed to be limited to circulatory disease mortality in Eastern Europe and male respiratory mortality in Western Europe.

UK evidence: summary and limitations

Tentative evidence exists for the UK of an interactive relationship between air pollution and socioeconomic status in which differential susceptibility affects health outcomes. However, several limitations restrict the conclusions that can be drawn:

- Most obviously, the UK evidence base is small, particularly when compared to the United States.
- Unlike elsewhere, all UK studies use cross-sectional study designs which limit the quality of the evidence. There are no studies examining how SES and air pollution exposure accumulate over the life course.
- Many UK studies rely on ecological associations; key variables such as health and SES are captured at the ecological (rather than individual) level. There is also a poor understanding of scale, with previous international work emphasising that findings can be highly sensitive to the chosen geographical unit of analysis.
- There is little understanding of the temporal resolution of pollution exposure and the implications for health inequalities. For instance, pollution can vary significantly by season and time of day. Most geographic studies focus on home locations yet people move between different environments as part of their daily routines.

Addressing pollution inequalities

There are some established policy measures and sources of guidance⁵²⁻⁵⁴ on how to intervene in pollution problems and their impact on health. Different measures and approaches are more or less appropriate to the particular pollutants and sources involved, with significant differences, for example, between point pollution sources, and those that are more diffuse. For air quality specifically, the National Institute for Health and Care Excellence have recently published guidance on ‘what works’ in air quality management, particularly in terms of reducing health impacts.⁵⁴

Guidance on addressing pollution inequalities and their relationship with health inequalities is though less well developed. It cannot necessarily be presumed that generic actions to address pollution problems will automatically reduce inequalities and improve the situation most substantially for those most exposed.⁵⁵ Whilst this logic may well hold in some circumstances⁵⁶, there is also evidence (as reviewed above) that air quality management strategies in the UK have not been as pro-equity as might be expected and that in relative terms deprived communities have benefitted less from improvements in air quality than others.²⁵ If then it is accepted that pollution inequalities should be specifically targeted and reduced, it follows that there is a need to have policies and measures to identify and act on these inequalities. Key examples of such measures include:

Appraisal of the impacts of planning decisions, government policies and strategies to explicitly include implications for environmental inequalities. This is to ensure that decisions are taken with full awareness of their potentially unequal consequences.²⁴ Established assessment methodologies applied in England often either require or provide scope for assessing ‘distributional effects’, but are typically poor at specifically identifying *environmental* inequalities⁵⁷, and beyond a few examples^{58,59} (see Box 2) are not generally carried out very thoroughly. Given the nature of the current evidence base, such appraisal needs to extend beyond the protected social characteristics identified in the 2010 Equality Act, to include socio-economic status.

Application of impact assessment methods in land use and other decision processes to explicitly address the cumulative effects of multiple decision processes, such as the cumulative effects on a community of a series of transport infrastructure and industrial developments. This is important given that, as noted above, pollution sources often accumulate in deprived areas where people’s health tends to be significantly worse. It is unfair to add further burdens on those already taking more than their ‘fair share’ and suffering additional health consequences, and impact assessments should clearly identify where this is taking place.

Targeting of investment in local pollution management measures specifically on more deprived communities where health indicators are most problematic.⁵² The identification of ‘pollution-poverty’ hotspots has been suggested as one way of implementing targeting¹⁹, and in particular where environmental quality standards are breached, offer the strongest support for claims of environmental injustice.²⁵

Actively supporting innovative community based approaches to identifying and addressing local pollution problems (see Box 3) recognising that deprived communities will typically have fewer resources and less capacity to participate and have influence on decision-making than others. The Environment Agency has some experience of advocating for and experimenting with participatory approaches to working with deprived communities.¹⁶ ‘Good neighbour agreements’ have also provided the basis for negotiating performance standards between industries and communities in some localities, although with varied outcomes.^{60,61}

Ensuring that socially disadvantaged groups are properly included in bio-medical studies. Whilst the weight of evidence from environmental justice research shows socially disadvantaged groups are often more exposed to environmental pollution, some of these groups (for example ethnic minorities, homeless) have been found to be under-represented in biomedical studies thus potentially biasing understandings of health outcomes.⁶²

In following and selecting from such approaches, two further considerations are important. First, it makes much sense to seek synergies with wider policies focused on addressing health inequalities.^{2,52,63,64} The greening of deprived areas is a good example, given that green spaces can be of direct and indirect benefit to physical and mental health⁶⁵ and tree and vegetation planting can play a role both in improving general environmental quality and in scavenging air pollutants before they reach sensitive lungs. Investment in sustainable transport modes is another good example of where there can be strong policy synergies.

Second, it is a generally accepted principle that those who are suffering from pollution inequalities should not be made responsible for addressing them - making the *polluted* rather than the *polluters* pay - and are not unfairly penalised by the implementation of pollution reduction policies. Policy responses focused principally on personal protective measures are problematic in these terms⁶⁶, as can be policies focused on economic penalties and/or with cost implications that have disproportionate impact on those with low incomes.⁶⁷ Progressive approaches can ameliorate such effects, including, for example, focusing car scrappage schemes more substantially on low-income households.⁶⁸

Box 2 Heathrow expansion and Equality Impact Assessment

In 2008 campaigners protesting against proposals to further expand Heathrow airport argued that a proper assessment and consultation on the 'equality' implications of the development had not been carried out, and lodged legal proceedings against the Department of Transport. Their case rested on the obligation on all public authorities, under the Race Relations (amendment) Act 2000, to ensure that their policies do not have disproportionate impacts on ethnic minority groups. The response was an initial 'Equality Impact Assessment' screening which concluded that a full assessment should be undertaken because of the high proportion of black and Asian minority ethnic (BAME) groups near to the airport. The full assessment, undertaken for various potential airport expansion options, concluded that:

“Each development option could result in both positive and negative noise, air quality and economic impacts on equality priority groups. BAME groups, children, young people, older people, women / carers, disabled people and those with low incomes are likely to be differentially affected by the development proposals. Additionally, BAME groups, children, older people and those on low incomes could also be affected due to their disproportional representation in particular areas around the airport.”

Box 3 Mapping for Change

Prof Muki Haklay and Louise Francis, University College London

Mapping for Change (MfC) is a social enterprise that was founded by University College London (UCL) and London 21 Sustainability Network in 2009. It builds on ongoing research at UCL, focusing on participatory mapping and participatory Geographic Information Systems (GIS). These focus on the use of geographic information technologies to work with communities to solve problems that they face. By using mapping and geographical technologies such as GIS to collect, analyse and display information about communities' life and environment, MfC projects have helped increase community engagement in the local environment, led to new environmental monitoring by local authorities and stimulated policy debate about noise and air pollution.

MfC specialises in community engagement, aiming to empower individuals and communities to make a difference to their local area through the use of mapping and geographical information. In particular, MfC works to provide benefit to individuals and communities from disadvantaged or marginalised groups, along with the organisations and networks that support those communities, where the goal is to create positive sustainable transformations in their environment.

Since 2010, MfC has been involved in community-led air quality studies. In these projects, MfC worked with communities to use a dense network of diffusion tubes to measure nitrogen dioxide levels at local locations. An early study in 2011 with seven community groups from across London showed that along main road networks NO₂ levels were as much as 75% above EU guidelines; it also highlighted issues in several residential back roads, used as 'rat-runs'. In Putney, concerns raised about air quality by the Putney Society, citing MfC findings, were successful in leveraging political support to lobby for change, leading Transport for London to introduce to the area new buses that comply with higher standards for emissions.

In another study, in the Barbican, in collaboration with the City of London, a year-long study was carried out in 2013-2014 which identified a number of pollutant hotspots in the area. More than 100 residents have been involved in the project, with many hosting a diffusion tube for a year. More than half of residents said that they would change their walking routes as a result of the research; 85% reported that they felt more aware of some of the legal and technical aspects of air quality and 90% reported an improved understanding of the health impacts of air quality in London. In addition, the City of London is considering how to regulate local traffic in order to reduce the exposure of the local residents to harmful pollution.

Author's suggestions for policy makers

There is now substantial evidence across different pollution types and sources that there are significant pollution inequalities in England, with measures of deprivation in particular shown to be associated with a higher pollution burden. For pollutants injurious to health, this implies *a priori*, an adverse effect on health inequalities. However, the interactive consequences of environmental inequalities for health inequalities are complex to firmly establish. More research and systematic attention to the interaction between pollution and health inequalities is undoubtedly needed, bringing together research domains that have remained largely separate, as recently recognised in a set of priorities laid out by Public Health England.⁵

There is however sufficient knowledge already in place to much better integrate pollution reduction and health inequality programmes and interventions. In addition to further research;

- Decision-making that has the potential to exacerbate or reduce pollution should be better informed about how these effects are distributed by social group, and the implications for inequality (*proactive inequality assessment*).
- The targeting of interventions to reduce pollution problems in particular places or communities should take account of the need to, at the same time, address health inequalities (*targeted intervention*).
- Communities should be closely involved in addressing pollution problems, particularly where health impacts are most severely experienced (*participatory monitoring and mitigation*).

References

1. Government H. Healthy lives, healthy people: our strategy for public health in England. Cm7985. London: HMSO; 2010.
2. Marmot M. Fair Society: Health Lives: Strategic Review of Health Inequalities Post 2010. The Marmot Review; 2010.
3. Woodward A, Kawachi I. Why reduce health inequalities? *Journal of Epidemiology & Community Health*. 2000;54(923-929).
4. Office for National Statistics. Life Expectancy at Birth and at Age 65 by Local Areas in England and Wales: 2012 to 2014. Available at <https://www.ons.gov.uk/peoplepopulationandcommunity/birthsdeathsandmarriages/lifeexpectancies/bulletins/lifeexpectancyatbirthandatage65bylocalareasinenglandandwales/2015-11-04>. 2015.
5. Public Health England. Chemical Hazards and Poisons Report: Issue 26. London; 2016.
6. Rivas I, Kumar P, Hagen-Zanker A. Exposure to air pollutants during commuting in London: are there inequalities among different socio-economic groups? *Environment International*. 2017;101:143-57.
7. Mitchell G, Dorling D. An environmental justice analysis of British air quality. *Environment and Planning A*. 2003;35(5):909-29.
8. Barnes J, Chatterton T. An environmental justice analysis of exposure to traffic-related pollutants in England and Wales. *WIT Transactions on Ecology and the Environment*. 2017;210(12): 431-42; Available from: <http://eprints.uwe.ac.uk/28882>.
9. Walker GP. *Environmental Justice: Concepts, Evidence and Politics*. Abingdon: Routledge; 2012.
10. Holifield R, Chakraborty J, Walker GP, editors. *Handbook of Environmental Justice*. Abingdon: Routledge; 2018.
11. Schlosberg D, Craven L, Matthews C, Agyeman J. Trends and directions in environmental justice: from inequity to everyday life, community, and just sustainabilities. *Annual Review of Environmental Resources*. 2016;41:321-40.
12. Reed MG, George C. Where in the world is environmental justice? *Progress in Human Geography*. 2011;35(6):835-42.
13. Friends of the Earth. *Pollution Injustice*. London: Friends of the Earth (England and Wales); 2000.
14. Friends of the Earth. *Pollution and Poverty - Breaking the Link*. London: Friends of the Earth (England and Wales); 2001.
15. Walker GP, Fay H, Mitchell G. *Environmental Justice Impact Assessment: an evaluation of requirements and tools for distributional analysis*. London: Friends of the Earth (England and Wales); 2005.
16. Chalmers H, Colvin J. Addressing environmental inequalities in UK policy: An action research perspective. *Local Environment*. 2005;10(4):333 - 60.

17. Environment Agency. Addressing environmental inequalities. Position Statement. Bristol: Environment Agency; 2004.
18. Lucas K, Walker G, Eames M, Fay H, Poustie M. Environment and Social Justice: Rapid Research and Evidence Review. London: Sustainable Development Research Network and Policy Studies Institute; 2004.
19. Walker G, Mitchell G, Fairburn J, Smith G. Environmental Quality and Social Deprivation. Phase II: National Analysis of Flood Hazard, IPC Industries and Air Quality. R&D Project Record E2-067/1/PR1. Bristol: The Environment Agency; 2003.
20. Walker G, Burningham K, Fielding J, Smith G, Thrush D, Fay H. Addressing environmental inequalities: flood risk. Science Report SC020061. Bristol: Environment Agency; 2007.
21. Damery S, Petts J, Walker G, Smith G. Addressing Environmental Inequalities: Waste Management. R&D Technical Report, SC020061/SR3, Bristol, Environment Agency; 2008.
22. Damery S, Walker G, Petts J, Smith G. Addressing Environmental Inequalities: River Water Quality. Bristol: Environment Agency; 2008. Contract No.: R&D Technical Report, SC020061/SR2.
23. Stephens C, Willis R, Walker G. Addressing environmental inequalities: cumulative environmental impacts. Bristol: Environment Agency; 2006. Contract No.: R&D Technical Report, SC020061/SR4.
24. Pye S, King K, Sturman J. Air quality and social deprivation in the UK: an environmental inequalities analysis Final Report AEAT/ENV/R/2170 to Defra. Didcot, Oxon: AEAT; 2006.
25. Mitchell G, Norman P, Mullin K. Who benefits from environmental policy? An environmental justice analysis of air quality change in Britain, 2001–2011. *Environmental Research Letters*. 2015;10(10):105009.
26. Deguen Sv, Zmirou-Navier D. Social inequalities resulting from health risks related to ambient air quality - A European review. *European Journal of Public Health*. 2010;20(1):27-35.
27. Braubach M, Fairburn J. Social inequities in environmental risks associated with housing and residential location—a review of evidence. *The European Journal of Public Health*. 2010;20(1):36-42.
28. Department of Environment FaRA. UK notification to the European Commission to extend the compliance deadline for meeting PM10 limit values in ambient air to 2011: Racial Equality Impact Assessment (England). London: DEFRA; 2009.
29. Fecht D, Fischer P, Fortunato L, Hoek G, de Hoogh K, Marra M, et al. Associations between air pollution and socioeconomic characteristics, ethnicity and age profile of neighbourhoods in England and the Netherlands. *Environmental Pollution*. 2015;198:201-10.
30. Royal College of Physicians. Every breath we take: the lifelong impact of air pollution. Report of a working party. London: Royal College of Physicians; 2016.

31. Buckingham S, Kulcur R. Gendered geographies of environmental injustice. *Antipode*. 2009;41(4):659-83.
32. Adamkiewicz G, Zota A, Fabian M, Chahine T, Julien R, Spengler J, et al. Moving environmental justice indoors: understanding structural influences on residential exposure patterns in low-income communities. *American journal of public health*. 2011;101(S1):238-45.
33. Walker G, Mitchell G, Fairburn J, Smith G. Industrial pollution and social deprivation: Evidence and complexity in evaluating and responding to environmental inequality. *Local Environment*. 2005;10(4):361 - 77.
34. Richardson EA, Shortt NK, Mitchell RJ. The mechanism behind environmental inequality in Scotland: which came first, the deprivation or the landfill? *Environment and Planning A*. 2010;42:223-40.
35. Higgs G, Langford M. GISscience, environmental justice and estimating populations at risk: the case of landfills in Wales. *Applied Geography*. 2009;29:63-76.
36. Macklin Y, Kibble A, Pollitt F. Landfill sites: impact on health from emissions. London: Health Protection Agency; 2011.
37. Bambra C, Robertson S, Kasim A, Smith J, Cairns-Nagi J, Copeland A, et al. Healthy land? An examination of the area-level association between brownfield land and morbidity and mortality in England. *Environment and Planning A*. *Environment and Planning A*. 2014;46(2):433-54.
38. Brainard J, Jones A, Bateman I, Lovett A. Modelling environmental equity: Exposure to environmental noise pollution in Birmingham UK. *Urban Studies*. 2004;41(13):2581-600.
39. van Kamp I, Davies H. Noise and health in vulnerable groups: A review. *Noise Health*. 2013;15:153-9.
40. Fairburn J, Butler B, Smith G. Environmental justice in South Yorkshire: locating social deprivation and poor environments using multiple indicators. *Local Environment*. 2009;14(2):139-54.
41. Wheeler BW. Health-related environmental indices and environmental equity in England and Wales. *Environment and Planning A*. 2004;36:802-22.
42. Pearce JR, Richardson EA, Richard J, Shortt NK. Environmental justice and health : the implications of the socio-spatial distribution of multiple environmental deprivation for health inequalities in the United Kingdom. 2010(April):522-39.
43. Briggs D, Abellan JJ, Fecht D. Environmental inequity in England: Small area associations between socio-economic status and environmental pollution. *Social Science and Medicine*. 2008;67(10):1612-29.
44. Bell ML, Zanobetti A, Dominici F. Evidence on vulnerability and susceptibility to health risks associated with short-term exposure to particulate matter: a systematic review and meta-analysis. *American Journal of Epidemiology*. 2013;178(6):865-76.

45. Bell ML, Zanobetti A, Dominici F. Who is more affected by ozone pollution? A systematic review and meta-analysis. *American Journal of Epidemiology*. 2014;180(1):15-28.
46. Westergaard N, Gehring U, Slama R, Pedersen M. Ambient air pollution and low birth weight - are some women more vulnerable than others? *Environment International*. 2017(March):0-1.
47. Rodriguez-Villamizar LA, Berney C, Villa-Roel C, Ospina MB, Osornio-Vargas A, Rowe BH. The role of socioeconomic position as an effect-modifier of the association between outdoor air pollution and children's asthma exacerbations: an equity-focused systematic review. *Reviews on Environmental Health*. 2016;31(3):297-309.
48. Wheeler BW, Ben Shlomo Y. Environmental equity, air quality, socioeconomic status, and respiratory health: a linkage analysis of routine data from the Health Survey for England. *Journal of Epidemiology and Community Health*. 2005;59(11):948-54.
49. Jephcote C, Chen H. Environmental injustices of children's exposure to air pollution from road-transport within the model British multicultural city of Leicester: 2000-09. *Science of the Total Environment*. 2012;414:140-51.
50. Richardson E, Pearce J, Tunstall H, Mitchell R, Shortt N. Particulate air pollution and health inequalities: a Europe-wide ecological analysis. *International journal of health geographics* 2013;12(1):34.
51. Halonen JI, Blangiardo M, Toledano MB, Fecht D, Gulliver J, Anderson HR, et al. Long-term exposure to traffic pollution and hospital admissions in London. *Environmental Pollution*. 2016;208:48-57.
52. Brunt H, Barnes J, Jones SJ, Longhurst JWS, Scally G, Hayes E. Air pollution, deprivation and health: understanding relationships to add value to local air quality management policy and practice in Wales, UK. *Journal of Public Health*. 2016:1-13.
53. Milojevic A, Niedzwiedz C, Pearce J, Milner J, MacKenzie I, Doherty R, et al. Socio-economic and urban-rural differentials in exposure to air pollution and associated health impacts in England *Environmental Health*. 2017;in press.
54. Excellence. NIfHaC. Air pollution: outdoor air quality and health (NG70) NICE Guideline. London: NICE; 2017.
55. Tonne C, Beevers S, Armstrong B, Kelly F, Wilkinson P. Air pollution and mortality benefits of the London Congestion Charge: spatial and socioeconomic inequalities. *Occupational and Environmental Medicine*. 2008;65(9):620-7.
56. Mitchell G. Forecasting environmental equity: air quality responses to road user charging in Leeds, UK. *Journal of Environmental Management*. 2005;77(3):212-26.
57. Walker GP. Environmental justice and the distributional deficit in policy appraisal in the UK. *Environmental Research Letters*. 2007(4):045004.
58. Department for Transport. Adding capacity at Heathrow airport: equality impact assessment. London: Department for Transport; 2009.

59. Pye S, Norris J, Searl A, Watkiss P, Wilkins G, Pooley M. London Low Emission Zone Health Impact Assessment Final report: a report for Transport for London. Didcot: AEA Energy and Environment; 2008.
60. Friends of the Earth Scotland. Love thy neighbour? the potential for good neighbour agreements in Scotland. Edinburgh: Friends of the Earth Scotland; 2004.
61. Illsley BM. Good Neighbour Agreements: the first step to environmental justice? *Local Environment*. 2002;7(1):69 - 79.
62. Morrens B, Den Hond E, Schoeters G, Coertjens D, Colles A, Nawrot T, et al. Human biomonitoring from an environmental justice perspective: supporting study participation of women of Turkish and Moroccan descent. *Environmental Health*. 2017;16(1):48.
63. Public Health England. Achieving Good Health for All. A framework for PHE action on health inequalities 2015–2020. London; 2015.
64. Brunt H, Barnes J, Longhurst J, Scally G, Hayes ET. Local Air Quality Management policy and practice in the UK: The case for greater public health integration and engagement. *Environmental Science and Policy*. 2016;58:52-60.
65. Wolch JR, Byrne J, Newell JP. Urban green space, public health, and environmental justice: The challenge of making cities 'just green enough'. *Landscape and Urban Planning*. 2014;125:234-44.
66. Zheng S, Sun C, Kahn M. Self-protection investment exacerbates air pollution exposure inequality in urban China (No. w21301). National Bureau of Economic Research; 2015
67. Friends of the Earth. The environmental reasons for reducing inequalities. London: Friends of the Earth; 2015.
68. Institute for Public Policy Research. Lethal and Illegal: Solving London's Air Pollution Crisis. London: IPPR; 2016.

Chapter 07

Environmental health - response to pollution

Chapter lead

Dr Naima Bradley¹

Chapter authors

Dr Naima Bradley¹, Dr Patrick Saunders², Dr Benjamin Fenech³, Vicki Rhodes⁴

1 Head of Environmental Hazards and Emergencies Department, Public Health England

2 Visiting Professor of Public Health, University of Staffordshire

3 Principal Noise and Health Scientist, Public Health England

4 Senior Specialist (Special Topics), Environment Agency

Summary

- Pollution has a significant negative, and largely avoidable, impact on health and well-being.
- Exposure to, and the effects of, pollution are influenced by other environmental, social and biological stressors.
- A good quality environment has a powerful positive effect on health and well-being.
- Environmental Public Health (EPH) addresses all aspects of health that are affected by the natural and built environment.
- A number of government departments, agencies and organisations work together to prevent or mitigate the impacts of environmental hazards on health in the home, in schools, at work and in the wider environment and improve health and well-being through safe, health promoting and empowering environments.
 - EPH professionals address the direct risks to public health arising from noise, air, water and land pollution and pollution arising from the transport, treatment and disposal of waste;
 - EPH professionals tackle the wider social determinants of health and environmental health inequities;
 - Environmental Health Professionals provide a wide range of public health functions at the local level, delivered through local authorities.

Introduction and background

At a local level, Environmental Health Professionals (EHPs) are public health professionals, currently largely employed by local government but also active in Public Health England, the NHS, academia, business and the third sector, and are a key component of the Environmental Public Health (EPH)¹ service. EPH is defined as all aspects of health that are affected by the natural and built environment. This remit includes, amongst other things, communicable disease control, food safety, inspection and enforcement, planning and building standards, and pollution control.

EHPs protect and improve the public's health and well-being through both regulatory and advocacy functions. They work in partnership with planners, Directors of Public Health and Public Health England teams, influencing change to secure environmental improvements in their localities. EHPs also enforce occupational safety standards preventing work-related ill health, such as occupational exposures - a significant burden for society, businesses and individual workers. This requires long term coordinated local action to make the essential sustained improvements.

Environmental hazards impact on health outcomes directly, through physiological exposure, and indirectly, e.g. concerns about perceived or actual exposures can be detrimental to mental health. As EHPs have a thorough knowledge of the local environmental risks and mitigation options, they are ideally placed to tackle these environmental inequities – and the health threats from pollution.

Closer working relationships between key organisations, agencies and government departments are central to the delivery of Environmental Public Health. Professionals within these organisations, agencies or departments may not see them themselves as being part of the public health workforce; however, they have a key role in bridging evidence, policy and practice for environmental public health gain. The 2013 return of the NHS public health function in England to locally accountable councils, which hold most of the levers of influence in this field, was widely welcomed as an opportunity to underpin interventions with both evidence and popular consent. There are several examples of where this integration is working well but it is important that this good practice is replicated across the country.²

Box 1 Contaminated land

Historically the United Kingdom was the first industrialised country in the world and as a consequence the UK is thought to have over 400,000 hectares of land which is contaminated, much of it as a legacy of the industrial Revolution¹. Contaminated land is an issue for public health due to the nature of the chemicals contained within the soil (which can sometimes be carcinogenic). Examples include lead which can lower IQ, benzo(a)pyrene which is carcinogenic and asbestos which can cause long latency cancers such as mesothelioma. When undertaking a contaminated land risk assessment the potential contaminant, the routes of exposure such as ingestion or inhalation and the potential duration of that exposure are considered.

Contaminated sites where there has been a real potential immediate risk of harm to health include those with elevated levels of contaminants such as arsenic and lead in formerly industrialised areas, which pose a real threat to young children. Inadvertent ingestion, pica tendencies and tracked-back dust into properties can result in a significant possibility of significant harm to young children.

Perceived risks to residents of remediation include the excavation and either treatment on site or removal off-site of these soils, which can lead to considerable anxiety and concerns to local residents.

The current gap in the UK for contaminated land is the lack of funding and suitably experienced staff within LAs to undertake their statutory duty. There is also no fixed methodology to ascertain acute risk from contaminants in soil that LAs can draw on. There are a number of organisations, which include members of the industry, trying to fill the gap such as the Society for Brownfield Risk Assessment (SOBRA), and CL:AIRE who publish guidance to support industry such as SOBRA's Design of an Activity Based Sampling Protocol for the Testing of Asbestos Fibre Release Potential from Residential Garden Soil which was published in 2015.

Source

<https://www.gov.uk/government/publications/land-remediation-bringing-brownfield-sites-back-to-use/land-remediation-bringing-brownfield-sites-back-to-use>

Health and the physical environment

Environmental health professionals have been protecting the public from environmental hazards since Victorian times (see Box 2). Their enforcement of laws to tackle dangerous levels of pollution in air, water, food and land, unsafe housing and working conditions, insect and rodent infestations, as well as improving basic standards of sanitation and fighting infectious diseases, has saved countless lives. EHPs also make an enormous contribution to making people's everyday lives better by preventing or stopping public health nuisances.³ These are not just irritations but serious threats to individual and community health and quality of life including fly tipping, anti-social behaviour such as noisy late night parties, garden bonfires producing choking clouds of smoke, and filthy and verminous living conditions. There are hundreds of thousands of such complaints made every year to local councils in England⁴ and while EHPs will always try to negotiate a resolution, they will use the law if necessary.

The success of EHPs since the 1840s can be seen everywhere in the quality of the air we breathe, the food we eat, the places we live, work and play in, and the huge reductions in levels of previously devastating diseases such as tuberculosis, cholera, food poisoning, and typhoid. However, we cannot be complacent. The physical environment continues to have a major impact on our health and some of issues we thought were things of the past have re-emerged or evolved. Broadly, for example, diseases such as tuberculosis have re-emerged, whilst specific to pollution, different mixtures of air pollutants have become a threat.⁵

We have had great successes in the past and we can do so again through understanding both the causes of ill health and the most effective interventions. We have also come to recognise that good quality environments improve health and well-being and that there are wide differences in the experience of both poor and good quality environments and the consequences of those experiences e.g. deprived people are likely to live in polluted environments and have poorer health.⁶ This applies to most aspects of the physical environment – including pollution – and, again, we are increasingly aware that there are important interactions between them. Polluted areas, for example, also tend to have higher concentrations of take away food outlets and fewer opportunities for safe recreation in green spaces; factors plausibly associated with obesity.⁷ Innovative urban design and planning control can help address all these issues, delivering a cost effective intervention by tackling multiple challenges and reducing inequalities at the same time.

Box 2 Pollution history and public health

Stephen Mosley, Leeds Beckett University

Anxiety about the pollution of air, water, and streets in the fast-growing cities of nineteenth century Britain saw the rise of the public health movement. The world's first industrial nation was also a pioneer in tackling the harmful side-effects of unplanned urban growth: sewer rivers, smoke-filled skies, and vast quantities of organic wastes (such as manure from horse-drawn transport). So-called 'filth diseases', most notably waterborne cholera, dysentery, and typhoid fever, became major killers in overcrowded cities. Noxious emissions from factory and domestic chimneys caused chronic respiratory diseases, especially bronchitis, which claimed many thousands of victims every year. Early industrial centres like Glasgow, London, and Manchester were 'devourers of population'.

By the 1830s, pressure was building on Britain's authorities to clean up polluted urban environments that contributed to serious health problems and preventable deaths. Influential figures rallying public opinion behind the sanitary movement included Edwin Chadwick (author of *The Sanitary Condition of the Labouring Population*, 1842), William Farr (medical statistician), and Thomas Southwood Smith (founder of the Health of Towns Association). Although the need for pure drinking water, clean air, and sanitary streets was not perfectly understood (miasmatic theories about disease transmission held sway), their lobbying helped to secure the passage of the first statutory nuisance legislation. In 1846 the Nuisance Removal Act gave justices the power to prosecute those responsible for urban 'nuisances' – defined broadly as accumulations of refuse, foul-smelling drains or cesspools, and 'unwholesome' housing – that were believed to be the source of 'bad air' and disease. And in 1848 the first Public Health Act empowered local authorities to manage refuse, sewage, and water systems. It also established a General Board of Health; an important step towards formalising the state's role in protecting the health of the nation. However, the implementation of public health legislation was slow initially. For example, it took London's Great Stink of 1858 and fears of a cholera outbreak – the faecal stench from the polluted River Thames was so disgusting that Parliament was suspended – before the money and political will was found to build an effective metropolitan sewerage system. The underground system, designed by Joseph Bazalgette, was then emulated countrywide.

Advances in waste removal and water supply saw mortality rates from ‘filth diseases’ decline dramatically by the turn of the twentieth century, but Britain’s cities still suffered from excessive levels of smoke pollution. As air pollution was closely linked with jobs and prosperity, anti-smoke clauses in public health legislation were weakly drafted and rarely enforced. The catalyst for change was London’s Great Smog disaster of December 1952, which brought about the premature deaths of around 12,000 people by exacerbating existing heart and lung conditions. Contemporaries finally understood that dirty air could be just as dangerous as contaminated water, and most supported the introduction of a tough Clean Air Act (1956) and the creation of smokeless zones in urban areas. By the 1980s coal smoke was no longer considered a significant factor in explaining respiratory deaths in Britain’s cities. As we struggle today with less tangible pollution problems, the history of public health shows that positive change is possible.

One of the key benefits of the return of the NHS public health function to local authorities⁸ has been the closer collaboration between environmental health, public health, planning, transport and housing professionals. It is this collaboration that we need to reduce the health burden from pollution. There are already many examples of imaginative collaborative practices such as ‘greening’ urban corridors, improving public transport and improving opportunities for walking and cycling. We need to continue finding opportunities for collaborative interventions that address multiple hazards and target them where they have the most impact: some local authorities have used industry quality control methods to review public health nuisance complaints and environmental threats to do just that.⁹ We now explore two areas of pollution, air and noise pollution, and the role that EHPs have in reducing this threat.

Environmental health opportunities – Air quality and environmental health

One of the more recent examples is in the area of air quality where environmental public health professionals in local authorities, government, academia, the NHS and health charities are working together to reduce the health burden attributable to air pollution^{10,11} Environmental legislation has been successful in tackling some of the traditional domestic and industrial sources. However, different air pollutant mixtures have evolved as the modern economy and our way of life is increasingly reliant on road vehicles. Ironically, this increase in road traffic is damaging not only to the global climate, health and the environment through the emission of air pollutants and noise, but also to the local economy due to, for example, road congestion and additional pressure on the NHS.

Box 3 Cold ironing

Dr Matthew Loxham, BBSRC Future Leader Fellow, Faculty of Medicine, Ocean and Earth Science, University of Southampton;

Over 90% of the world's trade travels by ship, the most fuel-efficient mode of transport per tonne of goods. When berthed in port (termed "hotelling"), cruise and cargo ships need to keep their systems powered, and therefore usually run their auxiliary engines. The resultant emissions may contribute significantly to local air pollution, contributing around 20% to the local air pollution load by source apportionmentⁱ, although other techniques have suggested greater contributions. A potential remedy is to connect hotelling ships to a shoreside electricity supply, allowing the auxiliary engines to be turned off, referred to as "cold ironing". As long as the electricity is from a relatively clean source (renewable/LNG/nuclear), this reduces emissions from hotelling ships to near zero. Unfortunately, shoreside power is not commonplace because of the inability of the local power grid to meet the demands of multiple hotelling ships, incompatibility between ship- and land-based electrical supply characteristics, initial financial outlay (e.g. €10 million for a recent terminal in Hamburg), and debate over who should bear the financial costs.

The Air Resources Board of California has introduced At-Berth Regulations to reduce emissions of NO_x and particulate matter from hotelling ships at six major ports in California. Currently, at least 70% of the passenger, container, and refrigerated cargo fleet's visits to regulated ports (80% by 2020) are limited to three hours of auxiliary engine operation with further limits on auxiliary engine power generation; additional power must come from shoreside supplies. Alternatively, approved emissions reduction technology, such as exhaust treatment systems, can be used. Importantly, emphasis is placed both on fleet operators to ensure that their ships are equipped with the necessary technology, and on port and terminal operators to ensure that infrastructure is available. Air pollution control agencies and port operators have made money available to contribute to equipment costs. Conversely, non-compliance is met with stringent financial penalties of up to \$10,000 per violation per day.

In the EU, funding has been made available through the Marco Polo programme, ahead of a 2025 deadline for mandatory installation of shoreside power. It is noteworthy that, while cold ironing is already in operation in several EU ports, including Gothenburg, Hamburg-Altona, and Rotterdam, it is not used in the UK and nor are there any concrete plans for its introduction. Although there are barriers to be overcome in its adoption, shoreside power offers obvious potential for improvements in port city air quality and associated pollution-related health outcomes. In the long-term, the costs of installation and operation are likely to be significantly outweighed by the cost savings in terms of the financial consequences of ill health due to shipping emissions which, including in-port and at-sea emissions, are estimated to exceed €64 billion in continental Europe by 2020.^{ii,iii}

References

- i M. Viana *et al.*, Impact of maritime transport emissions on coastal air quality in Europe. *Atmos. Environ.* **90**, 96-105 (2014).
- ii J. Brandt *et al.*, Assessment of past, present and future health-cost externalities of air pollution in Europe and the contribution from international ship traffic using the EVA model system. *Atmospheric Chemistry and Physics* **13**, 7747-7764 (2013).
- iii F. Ballini, R. Bozzo, Air pollution from ships in ports: The socio-economic benefit of cold-ironing technology. *Research in Transportation Business & Management* **17**, 92-98 (2015).

Renewed efforts are under way to ensure that local actions complement the global and national efforts. Environmental public health professionals are called to apply their expertise and experience in understanding the evolving evidence on the impact of environmental stressors on health, considering the needs of the local populations, work collaboratively to identify priorities and interventions, raise awareness amongst health professionals and advocate for behaviour change in order to reduce car usage and promote active travel.¹²

Box 4 A better real-world vehicle emissions ratings system

Nick Molden, Founder and Chief Executive Officer, Emissions Analytics

Emissions Analytics (www.emissionsanalytics.com) is a specialist in real-world emissions and fuel economy testing. Founded in 2011, it has now tested over 1,500 different vehicles using regulatory-approved equipment but on a standardised, independent protocol. Company funding and operations are independent of manufacturers and other interested parties.

Since 2016, Emissions Analytics has published free-to-access vehicle ratings based on its test data. These make up the EQUA® Index (accessed at www.equaindex.com). These ratings can be used by fleet and private buyers in vehicle purchasing, and by manufacturers to evidence the performance of their vehicles. Unlike official figures, the EQUA Index ratings provide the ability to base consumer information, incentives and access restrictions on real-world performance. This offers a promising route to achieve air quality goals as quickly as possible, and with the smallest private and public cost. For example, these data could act as a baseline for effective clean air zones (CAZs).

Real-world NO_x emissions compared to regulated levels (the European “Euro” Vehicle certification programme)

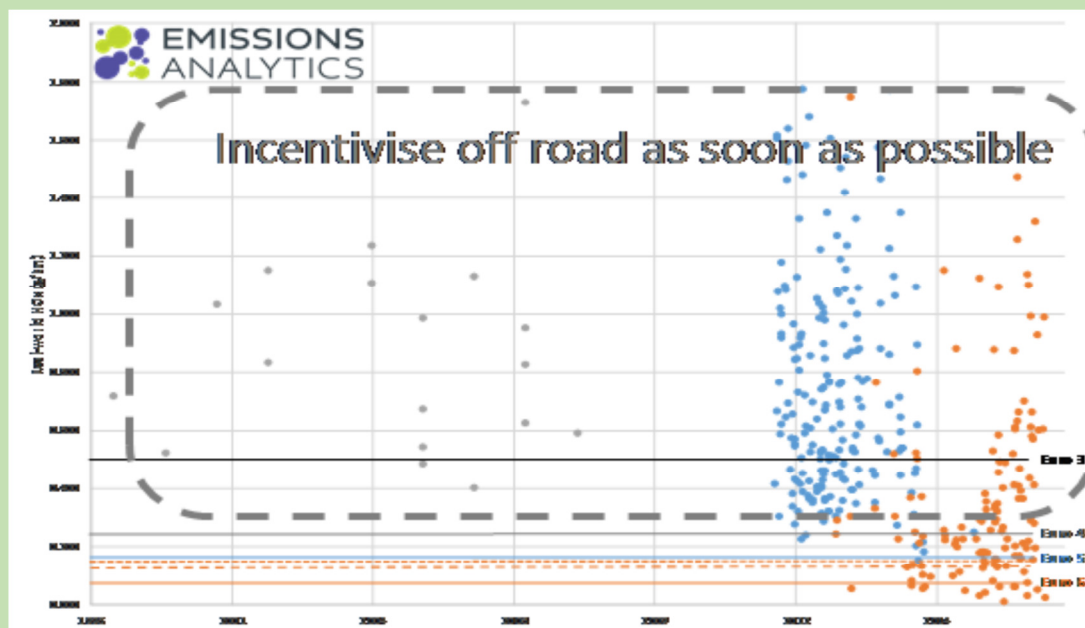

113

At each Euro stage (stricter restriction applied through time) the cleanest vehicles have been getting cleaner, as measured by the EQUA; the dirtiest vehicles have not. Therefore, any system of discriminating between vehicles based only on Euro stage will be inefficient, permitting some vehicles with high real-world emissions. To exemplify the divergence between Euro standards and EQUA index, the dirtiest Euro 6 diesels are six to seven times higher emitting than the cleanest Euro 5. More striking still, the dirtiest Euro 6 diesels are around three times worse than the cleanest Euro 3/4 vehicles (remembering a 14 year gap between Euro 3 and Euro 6). These variations are due to the official laboratory testing processes and exploitation of loopholes in the Euro standards regulation.

Using the EQUA Indices would allow governments and cities to target only those vehicles which are high emitting in practice, minimising the private and public cost. By using it, for example, estimates suggest that 54% of Euro 6 diesels would have to be restricted from urban areas to achieve an 87% reduction in nitrogen oxide emissions. The EQUA index has been designed in the light of lessons from other labelling schemes – typically based on official figures or where multiple pollutants are combined into a less transparent “eco” rating – to be simple, accurate and action-guiding. Manufacturers would compete to get the best ratings, as it would deliver them marketing, sales and reputation benefits, thereby harnessing the market to solve an environmental and health problem.

We must encourage environmental public health innovations, often driven by local democracy, as the status quo is not an option. In order to encourage behaviour change, such as encouraging active travel to improve health and reduce environmental pollution, we need to do more than simply enforce the law, we need to make the ‘doing the right thing’ the ‘easy thing to do’ and, along the way, change social attitudes as we have with smoking and drink driving. These interventions are investments not subsidies. Indeed, poor quality environments will put towns and cities at an economic disadvantage in attracting businesses.¹³ Well-planned and evidenced-based public health interventions are good value for money with high return on Investment and Cost Benefit Ratios.¹⁴ Transport-induced poor air quality, ill-health and road accidents costs society £40 billion per year. Getting one more child to walk or cycle to school could pay back as much as £768 or £539 respectively in health benefits, NHS savings, productivity gains and reductions in air pollution and congestion. Basic improvements to damp, cold and unsafe housing are an efficient use of resources. Every £1 spent on improving homes saves the NHS £70 over 10 years.

Environmental health opportunities – reducing noise pollution

As well as addressing the direct impact of environmental threats on clinical health outcomes, Environmental Public Health professionals are faced with environmental opportunities and challenges that can be beneficial for, or impact on, people's mental health and quality of life. One such issue is sound/noise. Sound is an essential element in our daily lives, allowing us to communicate and express our feelings and capture information about our environment.¹⁵ Noise is sound that occurs in the wrong place or at the wrong time that leads to a negative effect on health and well-being.¹⁶

The scale of noise as a public health issue is clear. Noise is the single largest issue of complaint made to local authorities in the UK. Transportation noise is the second-largest environmental health risk factor in Western Europe¹⁷ The annual social cost of urban road traffic noise in England is estimated at £7-£10bn.¹⁸ There is good evidence that transport related noise is associated with sleep disturbance, cardiovascular morbidity, cognitive impairment in children and chronic annoyance.¹⁹⁻

21

Figure 7.1 Reproduction of European Union Tyre label (with notes)

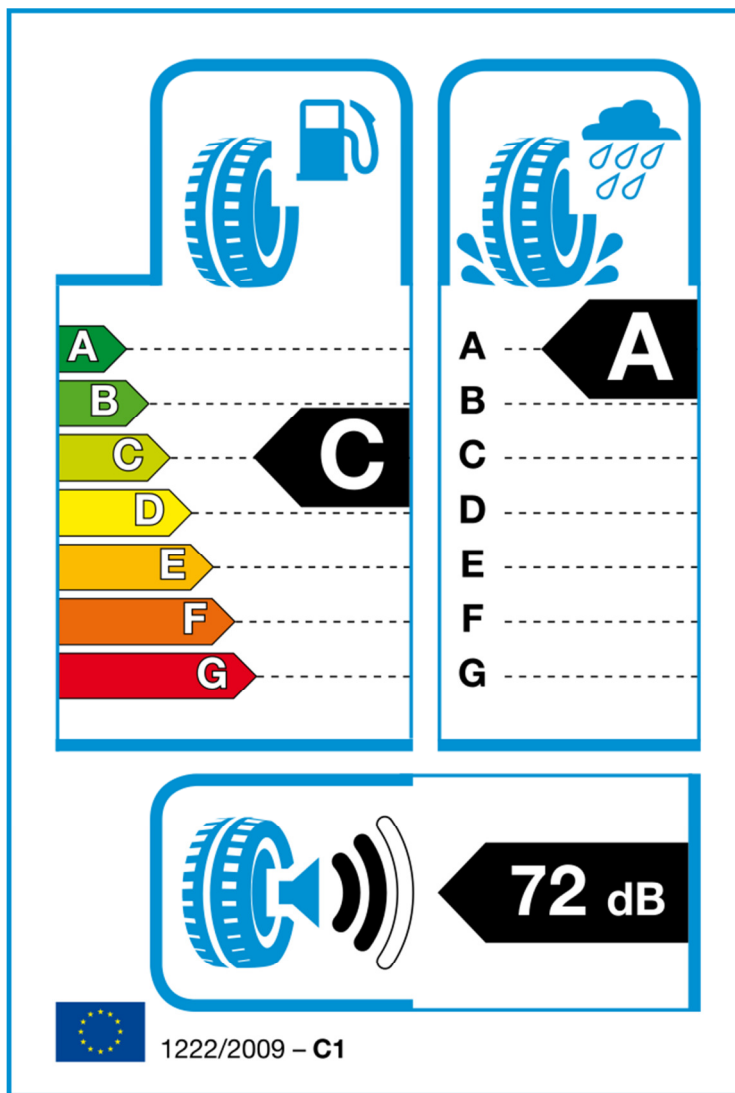

Note Environmental health practitioners have a role in informing the public of less polluting behaviours – for car drivers this means not leaving engines idling, driving more efficiently (going easy on the gas pedal and brakes) and replacing tyres with quieter alternatives.

Current EU legislation has established a framework for providing consistent information on three tyre parameters: fuel efficiency, wet grip and external rolling noise. The label provides ratings of noise both in decibels and in more general terms for those unfamiliar with the decibel system – black waves indicating whether the tyres are ‘quiet’, ‘moderate’ or ‘noisy’. Quieter tyres are generally no more expensive than standard tyres and perform similarly in terms of wet grip and rolling resistance.²²

Source Adapted from https://commons.wikimedia.org/wiki/File:EC_tyre_label_CA.svg

However, transportation is not the only noise source of concern. Environmental Health Practitioners are well aware of the impact of nuisances from neighbours and wider neighbourhood noise. One in ten people report themselves “very or extremely” bothered, annoyed or disturbed by noise from neighbours and other people nearby.³ Data from the Public Health Outcomes Framework²³ show around 400,000 complaints made to Local Authorities in England every year about neighbour and neighbourhood noise, and this represents only a small percentage (10-15%) of actions taken by those affected by noise.^{3,24} Several studies have shown that neighbour and neighbourhood noise can have a negative impact on physical and mental wellbeing in adults²⁴⁻²⁷, and one study found that exposure to neighbour noise at home is associated with conduct problems and hyperactivity in children.^{28,29} Statistics compiled in 2014-15 by the CIEH on Local Authority noise enforcement activity show that EHPs resolved 82% of complaints received.

The journey towards a healthier, less polluted, sound environment offers many challenges. Increasing urbanisation is bringing people’s dwellings closer together and closer to roads, railways, airports and industry. Major infrastructure projects are making construction noise a semi-permanent feature of the urban sound environment: the 24hr economy can be a barrier to people’s desire to “turn down the volume” at night to allow a good night’s sleep. But solving these problems is not just about reducing noise levels. Noise acts as a psychosocial stressor³⁰, and the psychological reaction to it is influenced strongly by a number of personal, situational and environmental factors.³⁰⁻³² A holistic sustainable development approach featuring good acoustic design^{33,34} can protect against adverse health outcomes by minimising exposure and maximising restorative opportunities such as respite³⁵ and tranquil urban areas.³⁶ Behavioural interventions such as coping strategies³⁷, should also be considered, particularly for those most at risk.

Box 5 A typical day in the life of an Environmental Health Professional

09.30 hrs:

Responds to complaints about a householder routinely lighting large bonfires producing clouds of dense smoke preventing neighbours from using their gardens. Advises the householder about the legal requirement not to create a 'nuisance' and explains the local authority services available for the disposal of garden and other waste. EHO will monitor the situation and serve a notice if there are further incidents.

10.00 hrs:

During the visit EHP is called to a privately rented property by tenants complaining of mould affecting the health of their newly born baby. The property has several structural defects, including a leaking roof which the landlord has refused to repair. EHP undertakes a thorough inspection of the dwelling based on the housing health and safety rating system (HHSRS), an evaluation tool to help local authorities identify and protect against potential risks and hazards to health and safety from deficiencies identified in dwellings.

11.30 hrs:

EHP attending a complainant's home that is in a filthy state with piles of rubbish and food waste cluttering the premises and where the adults smoke heavily while the children are watching television. The EHP had attended a training session on "making every contact count" (MECC) training the previous week and advises the parents on the health hazards, provides detail of the local stop smoking programme and liaises with social services colleagues to arrange the premises to be cleaned and the situation assessed for other hazards and interventions.

13.30 hrs:

Attends meeting with the Director of Public Health (DPH) and planning colleagues about the high levels of NO₂ around a heavily trafficked retail high street. Advises that given the impracticality of technical interventions, the council should consider, in collaboration with local businesses and residents, a no idling near the school campaign, a walking to school plan led by the pupils and parents and potentially, the installation of 'living walls' (panels of foliage) at strategic points including around a primary school. EHO and DPH advise on ensuring that the interventions are properly evaluated.

15:30 hrs:

Site visit for a planning application for dwellings with gardens. EHO makes recommendations to the planning inspector on the need for a more comprehensive contaminated land assessment by the developer.

16.30 hrs:

Completes the required evidential and legal documentation.

Acute incidents and pollution

Another aspect of protecting the environment is to anticipate, plan for and respond to acute pollution events. All human activity generates waste and this can become a threat to the environment and ultimately to human health. The UK generated 202.8 million tonnes of total waste in 2014. Over half of this (59.4%) was produced by construction, demolition and excavation, with households responsible for a further 13.7% (Figure 7.2).³⁸

Figure 7.2 Waste generation by source (United Kingdom, 2014)

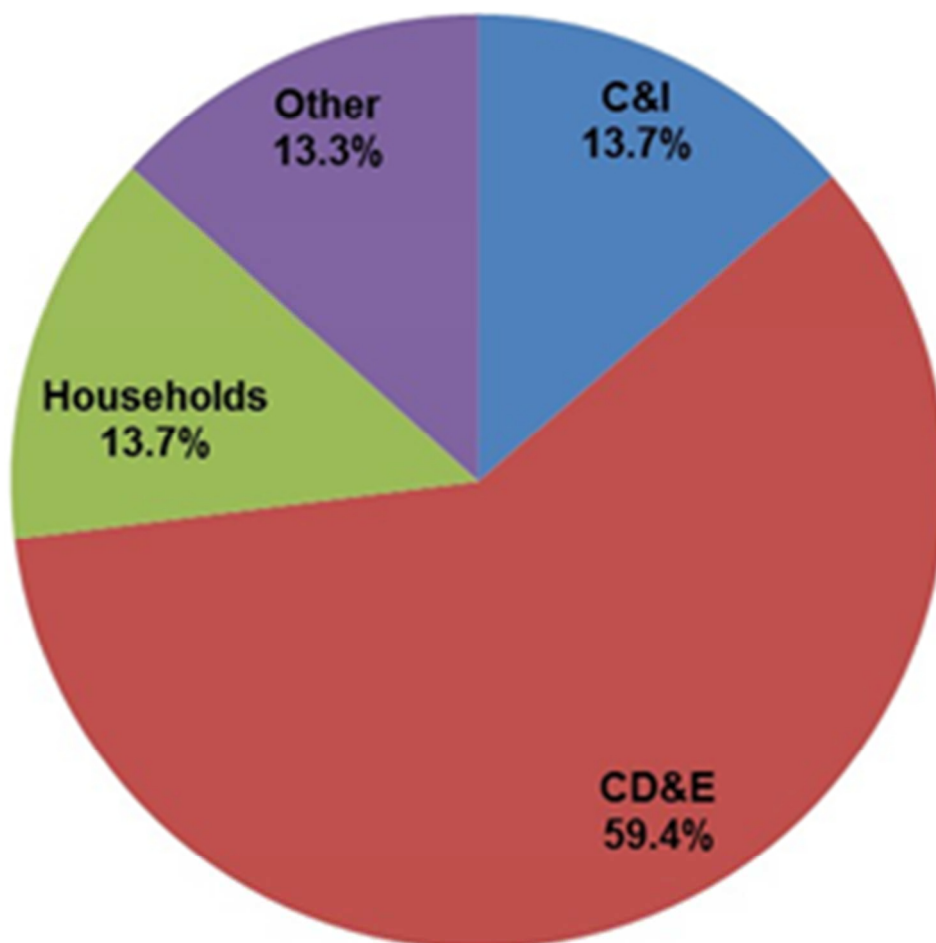

Note

C&I = Commercial & Industrial

CD&E = Construction, Demolition & Excavation and includes dredging

'Other' consists of waste from mining, agriculture, forestry and fishing

Source Bradley et al. using data from Health Protection Agency, Impact on Health of Emissions from Landfill Sites (2011)

The regulatory regimes to mitigate the potential public health risk posed by waste disposal and treatment such as deposition to landfill and incineration, are well documented.^{39,40}

For many years, the policy of prevention, re-use and recycling of waste products has driven up recycling rates (Figure 7.3).⁴¹ The preferred option is to reduce the amount of waste that is generated at source. If that is not possible, priority should be given to preparing the waste material so it can be easily re-used or turning it into another useful product or material (recycling). Although this has led to an improvement in the environment by reducing the impact of waste disposal activities such as air, water and land pollution due to landfill, it has also increased the number of waste storage sites.

Figure 7.3 The Waste Hierarchy

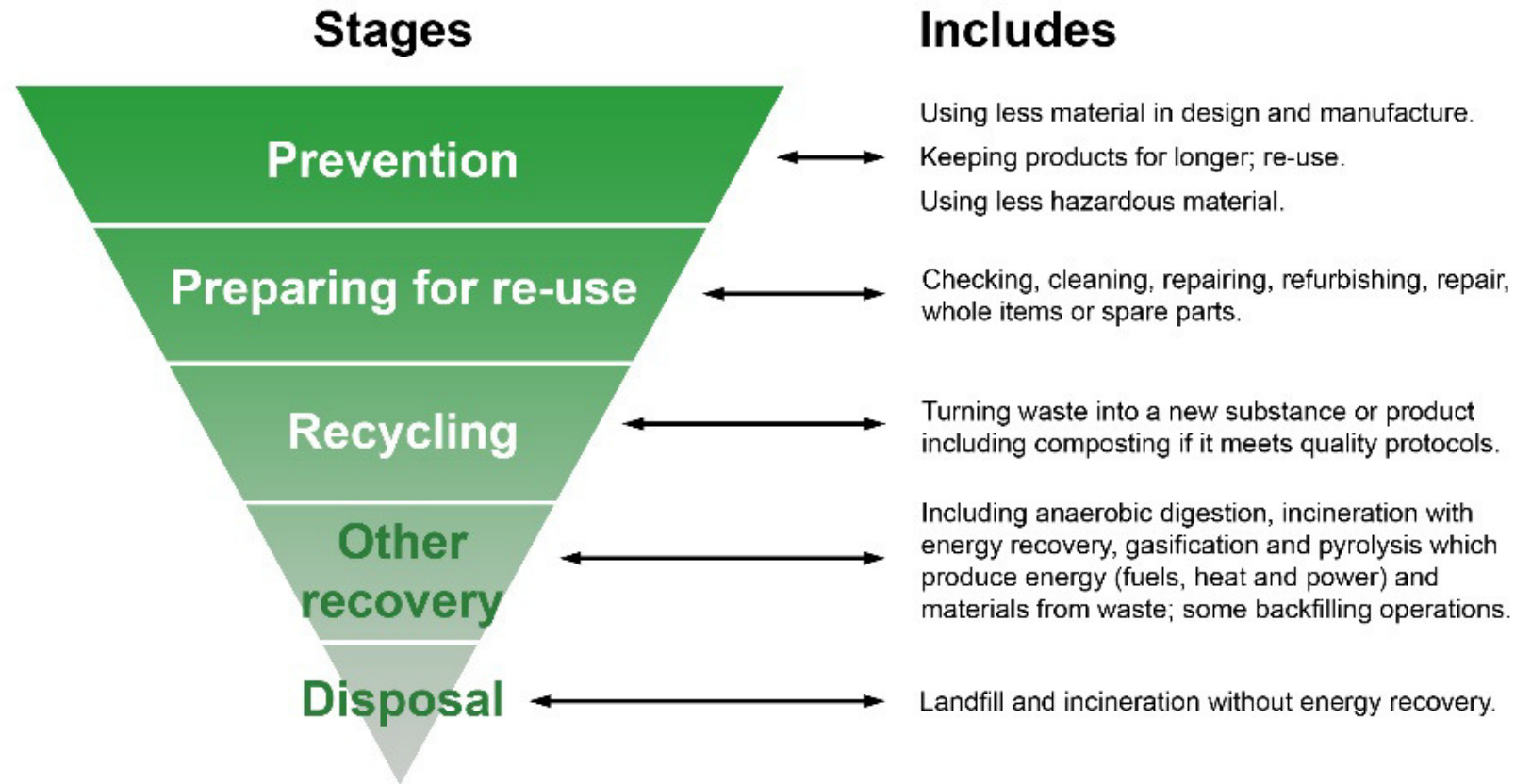

Waste facilities could harm human health by polluting the environment unless they are controlled. The environmental permitting regime requires operators to obtain permits for some facilities and ensures their ongoing supervision. Permitting aims to protect the environment, ensure policy and legislative standards are met and encourage best practice in operation of facilities.⁴² Of all the serious pollution incidents in 2015, 65% had an impact on water and 19% had an impact on air. Activities with permits caused 26% of incidents affecting water, and 71% of incidents affecting air. Non-permitted activities caused 61% of incidents affecting water, and 29% of incidents affecting air.³⁸

There are approximately 8,500 permitted sites storing combustible wastes in England and each year there are around 250-300 fires at such sites. Many of these fires occur at sites that are close to local communities, meaning that people can be affected by combustion products within the smoke. In addition to causing adverse effects on human health, smoke can cause significant disruption to major travel infrastructure, neighbouring businesses, and utilises resources from emergency responders.

The Environment Agency has a statutory duty to protect the public and the environment at those sites it regulates, by controlling emissions to air, land and water. These emissions include accidental releases from fires. (42). In 2015/16, the Environment Agency completed a formal consultation, and responses were received from Public Health England and other Emergency Responders. These comments were used to revise the regulatory guidance on fire prevention. This sets out clear objectives that site operators must achieve in order to reduce the overall likelihood and the impact of waste fires on the public and the environment.

The environmental permitting regime requires operators to obtain permits for some facilities and ensures their ongoing supervision. For permitted waste sites that store combustible wastes, conditions in the permit now require an operator to draw up a fire prevention plan. All plans have to be approved by the Environment Agency and are required to meet the objectives in the regulatory guidance. Over the next few years, the requirement for all existing 8,500 permitted sites to have an approved fire prevention plan is being phased in.

The composition of the smoke from these fires varies with the type of combustion, the availability of oxygen, the temperature and the materials involved. The immediate adverse health effects are likely to be caused by particulate matter, asphyxiants and irritants³⁵, particularly in the most vulnerable groups within the local community including children, the elderly and pregnant women. Current precautionary public health advice provided during many fire incidents is for members of the public to reduce their exposure by sheltering indoors; keeping windows and doors closed. However, sheltering becomes less effective over time if outdoor concentrations remain high. Effectiveness is dependent on people starting sheltering as soon as a

fire starts and stopping as soon as it ends. Many Fire and Rescue Services routinely use live social media feeds to inform the public of local incidents including fires. All emergency responders should encourage the public to follow these social media feeds, and to immediately shelter if they are within a 1km radius of a waste fire.

Box 6 Working together to manage risk from waste sites

It is not possible to prevent all fires and there is a need to minimise the duration of a fire, in order to protect members of the public from being exposed to unacceptable levels of smoke. In July 2016, the Environment Agency revised its regulatory guidance on Fire Prevention. Requirements are being phased in, so that all permitted sites storing combustible waste are required to draw up and implement a plan to meet the objectives of the guidance:

- to minimise the likelihood of a fire occurring;
- to extinguish a fire within 4 hours; and
- to minimise the spread of fire within the site and to neighbouring sites.

Waste sites that are regulated by local authorities, those that are illegal or exempt, do not comply with the objectives of the regulatory guidance.

When fires do occur there is very close working between the site operator, the Fire and Rescue Service, public health professionals, the local authority and the Environment Agency. Such joint working means the fire can often be brought under control quickly and a plan developed for putting it out. Where fires can be quickly extinguished, the health impacts on the local community are reduced significantly.

Box 7 Bio-aerosols and waste

Recycling waste can bring its own environmental challenges such as addressing concerns about the potential public health risk from bacteria and fungi arising from commercial composting sites.

The Environment Agency worked with PHE, academic and commercial partners to identify what levels of exposure to bioaerosol may be harmful, what contribution composting sites may make to the bioaerosol exposure of people living nearby, and how emissions can be mitigated. With our data we have developed a regulatory position that protects public health while minimizing the financial and regulatory burden on operators.

A literature survey indicated that there is evidence of health effects from exposure to high concentrations of bioaerosol in some occupational situations, but it is not clear whether measurable harm occurs at the lower concentrations typically found downwind of biowaste sites. A precautionary approach to regulation was therefore deemed necessary, under which composting sites would not contribute to ambient exposure.

- There is evidence of health effects from exposure to high concentrations of bioaerosol in some situations.
- It is not clear whether measurable harm occurs downwind of biowaste sites.
- Epidemiological studies confirmed that no statistically significant health impacts are found in people living 250m downwind of sites.
- Containment of composting mitigates bioaerosol emissions.
- Biofilters are primarily designed to reduce odour emissions. Their effectiveness to mitigate bioaerosols is variable.
- Stacks can be used to reduce ground level bioaerosol exposure.

In addition to public health risks from bioaerosol from waste facilities, there is a potential risk from intensive farming facilities. Further evidence is needed to inform us. A key question is whether bioaerosols downwind of these facilities pose a risk to public health with respect to the types of species found in the bioaerosol and the quantities.

Box 8 **Occupational exposures** *Health and Safety Executive*

Ill health that develops from exposures in the workplace continues to be a significant challenge. In 2016/17 an estimated 1.3 million people who worked were suffering from an illness they believed was caused or made worse by work and an estimated 13,000 deaths a year (12,000 lung disease deaths) are linked to past exposures to hazardous substances at work¹. In addition to the direct personal consequences, this results in a considerable economic burden.

New cases of work-related illness resulting from working conditions today (excluding long-latency illnesses) led to annual costs of £9.7 billion in 2015/16.ⁱ But past working conditions also continue to cause high costs today. The Health and Safety Executive (HSE) estimates that new cases of work-related cancer, caused largely by past exposures to carcinogens at work, resulted in costs of around £12.3 billion in 2010.ⁱⁱ

HSE's Health and Work strategyⁱⁱⁱ highlights the toll of work-related ill health and sets out the actions that it will take forward to address this challenge. Exposures resulting in work-related ill health can occur across all industry sectors irrespective of the sizes of the business. However, HSE cannot tackle all work-related ill health at once and it will focus on those health issues that have a widespread prevalence, the largest lost-time and economic-cost consequences and/or have life-altering or life-limiting impacts for the individual. Using a robust science and evidence base^{iv}, as well as considering the impact of the future world of work^v, HSE is prioritising its activity on tackling exposures that lead to:

- occupational lung diseases;
- musculoskeletal disorders; and
- work-related stress and related mental health issues.

HSE's activities are aimed at driving collective action in the health and safety system towards managing health in the workplace (see example) and it is engaging with a variety of stakeholders and partners including industry, trades unions and the wider workforce, Local Authority co-regulators, professionals and academia to develop its work on the priority health areas. Actions include championing the need for prevention, working with strategic partners and networks (national and international), directing HSE and Local Authority inspection and enforcement activity to where it can have the most effect and raising awareness with employers to promote behavioural change through the 'Go Home Healthy' campaign.^{vi}

An example of collaborative work HSE are undertaking for one of the health priority areas is aimed at **reducing ill health from exposure to respirable crystalline silica** (RCS) in brick making, stone masonry, foundries, quarries and construction industries. Activities include:

- **Engaging:** with workers and employers to drive interventions and behavioural change through facilitating specific industry partnership groups to implement tailored actions and novel communications materials e.g. the Quarries Partnership Team animated YouTube video to highlight good and bad working practices (www.safequarry.com).
- **Promoting:** key practical messages e.g. to consider workplace exposures when workers return to work after illness. Supporting partner's initiatives e.g. British Occupational Hygiene Society and their 'Breathe Freely' campaign aimed at the construction industry (<http://www.breathefreely.org.uk/>) and Institution of Occupational Safety and Health on the silica phase of their 'No Time to Lose' initiative (<http://www.notimetolose.org.uk/Free-resources/Silica-pack-lite-version.aspx>).
- **Anticipating new challenges:** through foresight and the synthesis of existing evidence to identify novel techniques to address RCS health and safety issues, e.g. in mask sampling for exposure measurement.
- **Evidence-based activity:** synthesis of the evidence base from 20 years of research findings, considered by the Workplace Health Expert Committee (lead by an independent Chair).
- **Longitudinal workplace research:** undertaking a study of workers in stone working, brick-making and foundries.
- **Policy and operational activity:** issuing supplementary RCS health surveillance guidance, alongside enforcement campaigns in targeted industries as part of wider activity.
- **Partnership working:** establishing a leadership body, the Healthy Lung Partnership across existing stakeholder groups to co-ordinate activity and provide direction on tackling occupational lung diseases.

References

All statistics are for Great Britain

1. Health and Safety Executive Statistics, 2016/17
<http://www.hse.gov.uk/statistics/index.htm> [Accessed 06/11/2017]
2. Health and Safety Executive, 2016. Costs to Britain of Work Related Cancer (Research Report 1074) <http://www.hse.gov.uk/research/rrhtm/rr1074.htm> [Accessed 18/05/2017]
3. Health and Safety Executive. Sector plans and Health priority plans,
<http://www.hse.gov.uk/aboutus/strategiesandplans/sector-health-plans.htm> [Accessed 08/12/17]
4. Health and Safety Executive, Annual Science Review, 2017
www.hse.gov.uk/research/content/science-review-2017.pdf
[Accessed 18/05/2017]
5. Health and Safety Executive, Foresight Report, 2016
www.hse.gov.uk/horizons/assets/documents/foresight-report-2016.pdf [Accessed 18/05/2017]
6. Health and Safety Executive Health Go Home Healthy Campaign
<http://www.hse.gov.uk/gohomehealthy/>
[Accessed 08/12/2017]

Authors' suggestions for policy makers

- Environmental pollution poses a significant burden for society, businesses and individuals. Long-term coordinated action is required to make sustained improvements. Focused engagement with stakeholders and networks of individuals to support behaviour change and develop the required awareness programmes to achieve tangible health outcomes is needed. The consolidation of the public health function in local government presents a great opportunity for focused, evidence based interventions driven by local needs.
- It important to recognise the full scope of environmental public health function, which includes research, regulation, policy development and advocacy functions. These functions are carried out by wide range of government departments, agencies, organisations and universities. It is crucial to consider all these activities when developing the multi-disciplinary workforce required to carry out all these functions.
- There is an urgent need to improve collaborative intelligence and horizon scanning activities for environmental public health threats to prioritise investment in research and prevention activities.

References

1. Bradley, N., Harrison H., Hodgson, G., Kamanyire, R., Kibble, A. and Murray, V. (Eds). *Essentials of Environmental Public Health Science: A Handbook for Field Professionals*. Oxford University Press, Oxford. 2014
2. Saunders PJ, Middleton JD, Rudge G. Environmental Public Health Tracking: a cost-effective system for characterizing the sources, distribution and public health impacts of environmental hazards. *Journal of Public Health* 2016
3. Chartered Institute of Environmental Health. Statutory nuisance. Available from: <http://www.cieh.org/policy/environmental-protection/statutory-nuisance.html> [Accessed 04/04/2017]
4. Department for Environment Food and Rural Affairs. *National Noise Attitude Survey 2012 (NNAS2012) Summary Report*. 2014. Available from: <http://randd.defra.gov.uk/Default.aspx?Menu=Menu&Module=More&Location=None&Completed=0&ProjectID=18288> [Accessed 05/06/2017].
5. Prüss-Ustün, A, Wolf, J; Corvalán, G; Bos, R and Neira, M. Preventing disease through healthy environments: a global assessment of the burden of disease from environmental risks. WHO Geneva, 2016.
6. Public Health England and UCL Institute of Health Equity. Local action on health inequalities: Improving access to green spaces. PHE London, 2014.
7. Morris G and Saunders PJ. The Environment in Health and Well-Being. *Environment and Human Health*. Oxford Research Encyclopedia of Environmental Science. Oxford Research Encyclopedias 2017
8. Department of Health. The new public health role of local authorities. 2012. Available from: https://www.gov.uk/government/uploads/system/uploads/attachment_data/file/213009/Public-health-role-of-local-authorities-factsheet.pdf [Accessed 04/06/2017]
9. Saunders PJ, Middleton JD and Rudge G. Environmental Public Health Tracking: a cost-effective system for characterizing the sources, distribution and public health impacts of environmental hazards. *Journal of Public Health* 2016; doi: 10.1093/pubmed/fdw130.
10. Royal College of Physicians. Every breath we take: the lifelong impact of air pollution. Report of a working party. London: RCP, 2016
11. Department for Environment Food & Rural Affairs, Public Health England and the Local Government Association. Air Quality - A briefing for Directors of Public Health. March 2017. http://www.adph.org.uk/wp-content/uploads/2017/03/6.3091_DEFRA_AirQualityGuide_9web.pdf [Accessed 30/09/2017]
12. Department for Environment, Food and Rural Affairs. Air Quality- A Briefing for Directors of Public Health. March 2017. Available at: <https://laqm.defra.gov.uk/assets/63091defraairqualityguide9web.pdf> [Accessed 04/06/2017]

13. Grant Thornton. *Five ways to attract business to your city*. London; 2016. Available from: <https://www.grantthornton.global/en/insights/growthiq/five-ways-to-attract-business-investment-to-your-city/> [Accessed 04/04/2017]
14. Masters R et al. Return on investment of public health interventions: a systematic review. *Journal of Epidemiology and Community Health* 2017; doi: 10.1136/jech-2016-208141.
15. Lercher P, Schulte-Fortkamp B. Soundscape of European cities and landscapes – Harmonising. In *COST Action TD0804 - Soundscape of European Cities and Landscapes*. 2014. Available from: <http://soundscape-cost.org/index.php/public-resource/publications> [Accessed 05/06/2017].
16. Health Protection Agency . *Environmental Noise and Health in the UK - a report by the Ad Hoc Expert Group on Noise and Health*. 2010.
17. Hänninen O, Knol AB, Jantunen M, Lim TA, Conrad A, Rappolder M, Carrer P, Fanetti AC, Kim R, Buekers J, Torfs R, Iavarone I, Classen T, Hornberg C, Mekel OC, EBoDE Working Group (2014). Environmental burden of disease in Europe: assessing nine risk factors in six countries. *Environ Health Perspect* 122:439–446.
18. Department for Environment, Food and Rural Affairs (Defra). *Noise pollution: economic analysis*. Available from: <https://www.gov.uk/guidance/noise-pollution-economic-analysis> [Accessed 05/06/2017].
19. World Health Organization Regional Office for Europe. *Burden of disease from environmental noise. Quantification of healthy life years lost in Europe*. 2012. Available from: http://www.who.int/quantifying_ehimpacts/publications/e94888/en/ [Accessed 5th June 2017].
20. Basner M, Babisch W, Davis A, Brink M, Clark C, Janssen S, Stansfeld S. Auditory and non-auditory effects of noise on health. *Lancet*. 2014; 383(9925), 1325–1332.
21. Department for Environment Food and Rural Affairs . *Environmental Noise: Valuing impacts on: sleep disturbance, annoyance, hypertension, productivity and quiet*. 2014. <https://www.gov.uk/guidance/noise-pollution-economic-analysis> [Accessed 05/06/2017].
22. European Commission Science for Environment Policy. Future Brief: Noise abatement approaches. 2017. Available from: http://ec.europa.eu/environment/integration/research/newsalert/pdf/noise_abatement_approaches_FB17_en.pdf [Accessed 05/06/2017].
23. Public Health Outcome Framework. *Wider determinants of health*, Indicator 1.14i 2014/15 data. Available from <http://www.phoutcomes.info> [Accessed 05/06/2017].
24. AECOM. *Survey of Noise Attitudes (2013)*. Report Ref: 47067932.NN1501.R1/02. Available from: http://randd.defra.gov.uk/Document.aspx?Document=13319_NANR322SoNA2013ReportFinalNov2015.pdf [Accessed 05/06/2017].

25. Fujiwara D. The social impact of housing providers. 2013. <http://www.hact.org.uk/sites/default/files/uploads/Archives/2013/02/The%20Social%20Impact%20of%20Housing%20FINAL.pdf> [Accessed 18/08/2017]
26. Guite HF, Clark C, Ackrill G. The impact of the physical and urban environment on mental well-being. *Public Health* (2006) 120, 1117–1126.
27. Kahlmeier S, Schindler C, Grize L, Braun-Fahrländer C. Perceived environmental housing quality and wellbeing of movers. *J Epidemiol Community Health* 2001; 55:708–715.
28. Shiue I. Neighborhood epidemiological monitoring and adult mental health: European Quality of Life Survey, 2007–2012. *Environ Sci Pollut Res* (2015) 22:6095–6103.
29. Dreger S, Meyer N, Fromme H, Bolte G. Environmental noise and incident mental health problems: A prospective cohort study among school children in Germany. *Environmental Research* 143 (2015) 49–54.
30. Job RFS. Community response to noise: a review of factors influencing the relationship between noise exposure and reaction. *J. Acoust. Soc. Am.* 1988; 83: 991–1001.
31. Miedema HME, Vos H. Demographic and attitudinal factors that modify annoyance from transportation noise. *J. Acoust. Soc. Am.* 1999; 105 (6).
32. Vos J. On the relevance of nonacoustic factors influencing the annoyance caused by environmental sounds - A literature study. *Proceedings to Internoise*. 2010
33. Kropp W, Forssén J, Estévez Mauriz L (ed.) *Urban Sound Planning – the SONORUS project*. 2016. Available from: <http://www.ta.chalmers.se/downloads/open/intro/UrbanSoundPlanning.pdf> [Accessed 05/06/2017].
34. Professional Practice Guidance (ProPG) on Planning and Noise. Jointly published by Acoustics & Noise Consultants, Institute of Acoustics and Chartered Institute of Environmental Health. May 2017. <http://www.ioa.org.uk/publications/propg> [Accessed 18/08/2017]
35. Anderson Acoustics. *A review on the state of the art on respite. Respite working group report*. 2016. Available from: http://hacan.org.uk/wp-content/uploads/2013/06/2694_FinalReport_2-0_June-2016.pdf [Accessed 05/06/2017].
36. TNO. *QSIDE - The positive effects of quiet facades and quiet urban areas on traffic noise annoyance and sleep disturbance. Layman's report*. 2013. Available from: <http://www.qside.eu/proj/pub/QSIDElaymansreport.pdf> [Accessed 05/06/2017].
37. Lercher P, van Kamp I, von Lindern E. Transportation noise and health-related quality of life: perception of soundscapes, coping and restoration. *Proceedings to Euronoise* 2016.
38. Department for Environment, Food and Rural Affairs (Defra), UK Statistics on Waste. December 2016. Available from: https://www.gov.uk/government/uploads/system/uploads/attachment_data/file/

- 593040/UK_statsonwaste_statsnotice_Dec2016_FINALv2_2.pdf. [Accessed 04/04/2017]
- Digest of Waste and Resource Statistics – 2017 Edition:
https://www.gov.uk/government/uploads/system/uploads/attachment_data/file/607416/Digest_of_Waste_and_Resource_Statistics__2017_rev.pdf
[Accessed 15/01/2018]
39. Health Protection Agency. Impact on Health of Emissions from Landfill Sites. 2011. Available from:
https://www.gov.uk/government/uploads/system/uploads/attachment_data/file/334356/RCE-18_for_website_with_security.pdf [Accessed 04/04/2017]
40. Health Protection Agency. Municipal waste incinerator emissions to air: impact on health. Health Protection Agency 2009. Available from:
<https://www.gov.uk/government/publications/municipal-waste-incinerator-emissions-to-air-impact-on-health> [Accessed 04/04/2017]
41. Department for Environment, Food and Rural Affairs (Defra). Guidance on applying the Waste Hierarchy. 2011.
<https://www.gov.uk/government/publications/guidance-on-applying-the-waste-hierarchy> [Accessed 04/04/2017]
42. Environment Agency. Environmental Permitting Guidance, Core guidance for the Environmental Permitting (England and Wales) Regulations 2010. March 2013. <https://www.gov.uk/government/publications/environmental-permitting-guidance-core-guidance--2> [Accessed 12/06/2017]
43. Wakefield J.C. A toxicological review of products of combustion products. 2010. Available at <https://www.gov.uk/government/publications/combustion-products-a-toxicological-review>. [Accessed 04/04/2017]

Chapter 08

Environmental pollution - data, surveillance and health impacts

Chapter lead

Paul Elliott¹

Chapter authors

Paul Elliott¹, Frédéric B. Piel¹, Daniela Fecht¹, Anna L. Hansell¹

¹ UK Small Area Health Statistics Unit (SAHSU), MRC-PHE Centre for Environment and Health, Department of Epidemiology and Biostatistics, School of Public Health, Imperial College London

Summary

- The large volume of data on pollution and health outcomes now, and becoming available ('big data'), provide exceptional opportunities to carry out investigations into the impacts of environmental pollution on human health and for the detection ('surveillance') and prevention of non-communicable diseases in England and elsewhere.
- The data needed to realise these opportunities include information about personal and population exposures to environmental pollutants, for example, through novel -omics techniques and use of biomarkers, linked to individual health records and geocoded routine health statistics.
- Analyses of such data will improve our understanding of the health implications of exposures to a complex range of pollutants over both short and long time periods. In addition, developments in computational processing, novel spatio-temporal statistical methodologies and innovative technologies such as data mining and artificial intelligence, will facilitate detection of unusual signals in the routine health and pollution data for surveillance and environmental public health tracking.
- A multi-disciplinary approach is needed, as exemplified by studies conducted by the UK Small Area Health Statistics Unit (SAHSU). On-going funding is required both to maintain and develop infrastructure to receive, curate, hold, link and analyse such data, as well as for specific research projects.
- Despite the large volume of data available, they are not necessarily easy to access and use. Robust procedures need to be in place to assure the quality and completeness of data, to make them available for research in timely fashion across different linked data sources and to ensure that ethical and information governance requirements are met.

Overview

Exposure to environmental pollutants, for example from air and water, is an inevitable consequence of everyday living. Studies of the effects of environmental pollutants on health have often been limited by a lack of high quality information on what people are exposed to, where and when the exposure occurs and by problems linking pollutant data to health outcomes, especially over the long term. Interpretation of health effects linked to a specific pollutant may be complicated by impacts of lifestyle factors, socioeconomic deprivation and exposure to more than one pollutant at a time. Better and more integrated data will help to overcome these problems for researchers, providing a stronger evidence base for policies to reduce exposure to environmental pollution and consequently improve health. A further issue arises where the impacts on health of any one pollutant may be relatively small and difficult to detect compared with the effects of lifestyle and other causes (see Chapter 10 of this report, 'Measurement and communication of health risks from pollution'). Detecting small risks reliably requires large studies – and large datasets. However, increases in disease risk that may appear small for any one individual may be important for public health as overall they can add up to a large disease burden across the population.¹

Vast amounts of electronically stored data are now being collected about us, the way we live and our environment, including information on pollutants and our lifestyles (Annex 3). These data can, in principle, be linked to health data to investigate risks to health. Sources of health data include national health datasets, such as birth and death records, general practice patient records, hospital admissions and other National Health Service (NHS) data (Annex 4), as well as information from specific surveys and personal monitoring devices. Through appropriate linkages of the pollution and health data, these 'big data' resources can provide remarkable opportunities to:

- rapidly investigate associations between our health and the environment we live in;
- identify demographic, environmental and socioeconomic risk factors for specific diseases and ill-health;
- inform public health policies by improving our scientific understanding about the ways in which environmental factors may influence health.

Analysis of these data requires the careful use of appropriate methodologies, allowing other important health risk factors such as age, socioeconomic status and ethnicity to be accounted for. Small area studies, such as neighbourhood studies, allow for the linkage of such data from multiple sources (Box 2). Small-area studies have been used to map disease risks (Figure 8.1) and pollutant concentrations (Figure 8.2), and to investigate potential health risks associated with various pollutants and exposures. Examples include waste disposal^{2,3}, temperature

extremes^{4,5}, air and noise pollution^{6,7}, chlorination by-products in the water supply^{8,9}, and electromagnetic fields from overhead power lines and mobile phone masts.¹⁰⁻ National data coverage also allows the investigation of the extent by which different population groups, defined by geographical region or socioeconomic characteristics, are exposed to different levels of environmental pollutants (termed environmental inequality).¹³⁻¹⁶

Box 1 The UK Small Area Health Statistics Unit

The UK Small Area Health Statistics Unit (SAHSU, <http://www.sahsu.org/>) holds many of the routinely collected national health, environmental and socio-demographic data in the UK.¹⁷ It was set up 30 years ago following the observation of an excess risk of leukaemia and lymphoma among children and young people living near the Sellafield nuclear plant.¹⁸ SAHSU has a national remit to develop methodologies, particularly for small areas (neighbourhoods) to improve detection of health risks from pollution, to conduct targeted research and monitoring and advise government on unusual clusters of disease. It has an international reputation as a centre of expertise in methods in spatial and environmental epidemiology. Overall, SAHSU collects, curates and maintains more than 600 million UK health records. The development of new biostatistical methodologies^{19,20}, the use of state of the art geographical information systems (GIS) to integrate data and develop advanced environmental models^{21,22}, offer a powerful approach to study potential health risks to the public.

Data mining capabilities, already commonly used for commercial and marketing purposes in other settings (for example, by search engines, banks, supermarkets and on social media), are starting to be used in health research, and offer the prospect of analysing national sources of health data for public health surveillance. The government Chief Scientist's Blackett report on wide-area surveillance²³ recently concluded that the rapid detection of unusual health signals would have significant benefits for public health. The use of such methods for health surveillance in the public good needs careful attention to privacy and data security, as enshrined in Caldicott principles in the UK²⁴⁻²⁶ and the European General Data Protection Regulation (GDPR, <http://www.eugdpr.org/>).

Figure 8.1 Disease incidence maps of (a) lung cancer in women and (b) mesothelioma in men extracted from SAHSU's Environment and Health Atlas for England and Wales

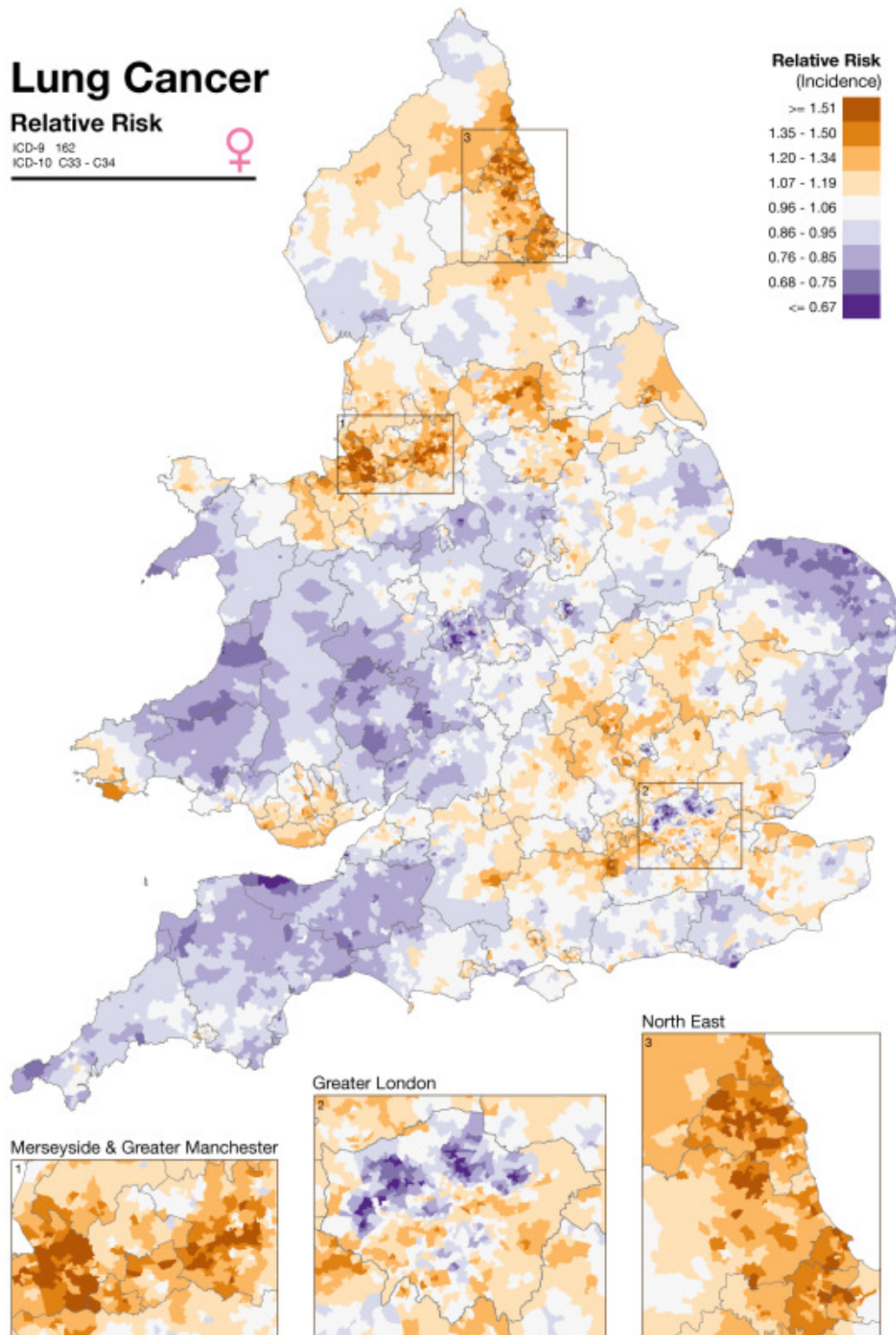

Mesothelioma

Relative Risk

ICD-9 163
ICD-10 C45



Relative Risk (Incidence)

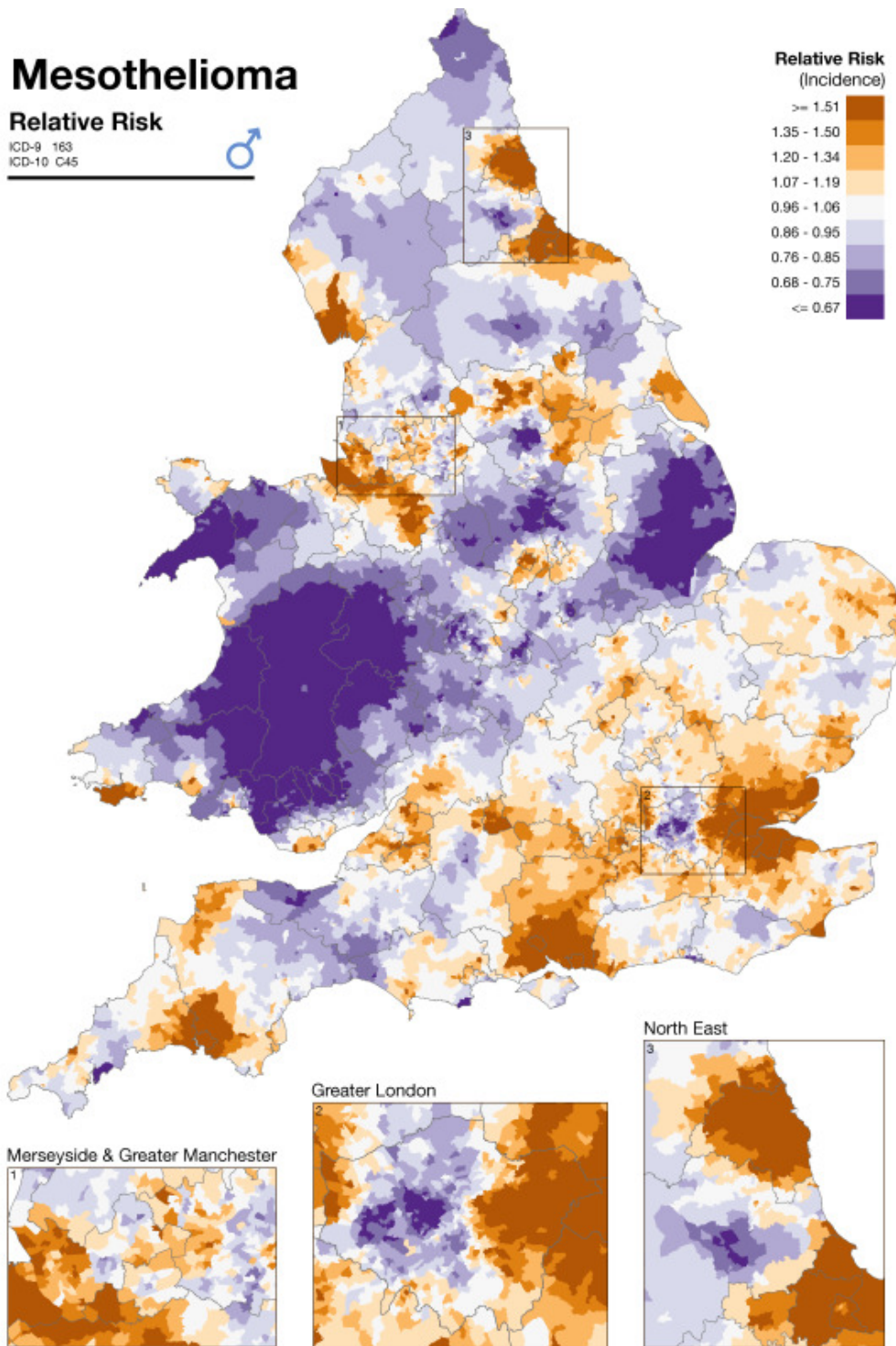
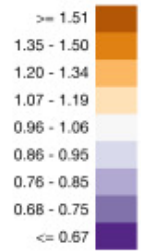

isks
racer
of

mesothelioma secondary to occupational asbestos exposure.

2. Maps are available online at www.envhealthatlas.co.uk and can be searched by postcode.

Figure 8.2

Maps of (a) nitrogen dioxide concentrations (NO_2 , $\mu\text{g}/\text{m}^3$), 100m \times 100m annual average concentrations for 2001 developed using land use regression (LUR), and (b) herbicide usage (kg) per census ward in 2000

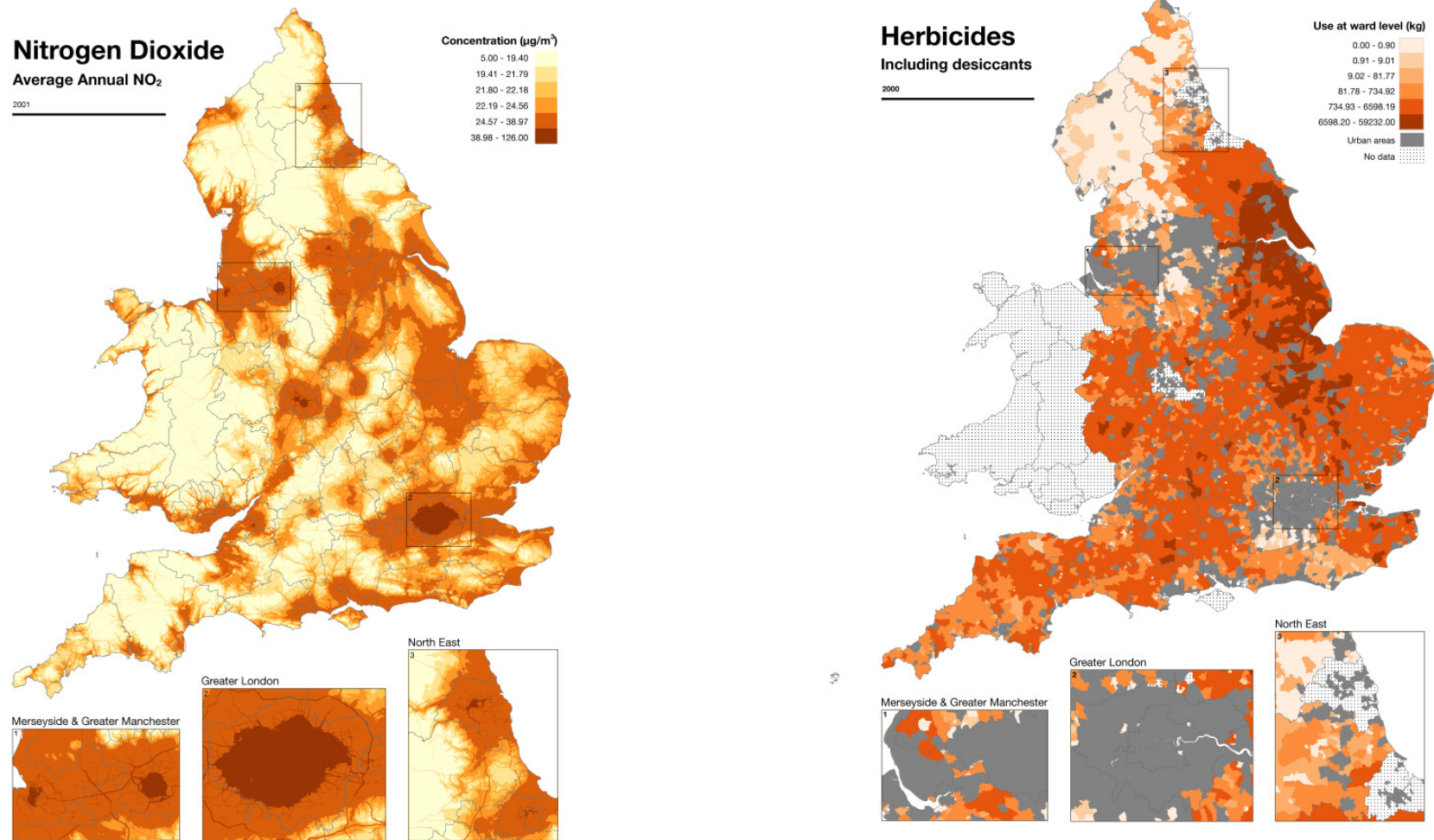

Source

Extracted from SAHSU's Environment and Health Atlas for England and Wales and based on data from the English Department for Environment, Food and Rural Affairs (DEFRA) and the Pesticides Usage Survey (PUS), respectively.

Note

Maps show higher levels of NO_2 in urban areas reflecting road traffic as a major source, and higher usage of herbicides in agriculture intensive areas.

A new era of big data

Accurately estimating exposure to environmental pollution and relating that to health over the lifecourse is a major challenge. We provide below an overview of the major sources of data to investigate ongoing impacts of pollution on our health and present some of the methodological opportunities and challenges associated with processing and analysing such big data.²⁸

The exposome – the totality of exposures

The concept of the exposome is providing a new systems-wide paradigm to help understand the health effects of environmental pollution. The exposome covers the totality of all types of exposures – from genetic/genomic sources, lifestyle and diet, psychosocial, medical, occupational and other sources, as well as environmental pollutants – over a person's lifetime. This concept should help researchers gain new mechanistic insights into disease causation and progression and to develop novel approaches to treatment and disease prevention.²⁹⁻³² It involves bringing together data on measured (e.g. personal monitoring device) and modelled (e.g. interpolation based on monitoring network) exposures and biological dose (e.g. from biomarkers), as well as potential health effects.

Biological signatures cover a wide range of molecules, including metabolites in blood or urine (metabolomics), proteins (proteomics), mRNA (transcriptomics), and covalent complexes with DNA and proteins (adductomics) (Figure 8.3). Such rich biological information allows the assessment of the internal (chemical) and external (environmental pollutants and stressors) exposures of an individual, especially during critical life stages. Proof of concept studies have identified, for example, metabolic profiles that detect early effects of environmental and lifestyle exposure to³³, and susceptibility to tobacco smoke-induced cardiovascular diseases among women.³⁴

Figure 8.3 The exposome concept

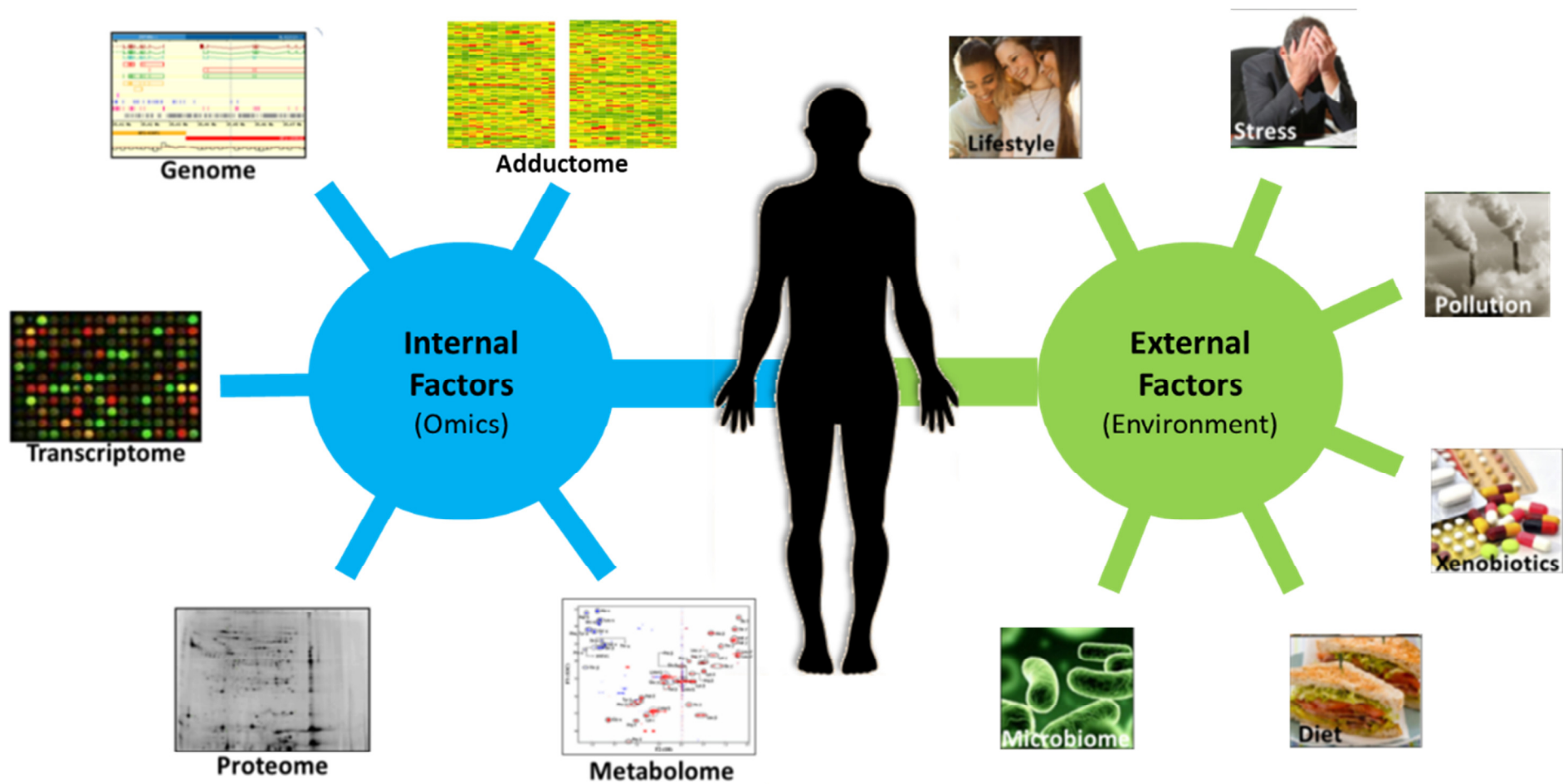

Big data on environmental pollution

The 'big data' revolution is providing much improved information on pollution and pollutant sources. Publicly available data, based on satellite images, aerial photographs and ground surveys conducted at increasing resolution, tell us about land use changes, the precise geographical location of roads, industrial facilities and waste disposal sites, patterns of light pollution and pollen concentrations and other sources of environmental pollution. Routine meteorological and air quality monitoring stations generate precise localised time series for large urban areas and reliable modelled surfaces nationwide. Local monitoring networks, such as the London Air Quality Network^{*****} which provides estimates of air pollution for 20m grids across the city (one of the most advanced such systems worldwide), allow users to access detailed hourly forecasts of local air pollution levels (Figure 8.4a). These can then be used to offer advanced services, for example, a route planner to identify routes that minimise exposure to air pollutants when walking or cycling in London.⁺⁺⁺⁺⁺

It is not practical to make pollutant measurements on the whole population, but models can provide proxy estimates of pollution exposures experienced by individuals. Local monitoring networks support the development of detailed air pollution models to assign air pollution exposure to individuals, for example, at their residential address (Figure 8.4b). A standard method for modelling residential air pollution is land use regression (LUR).³⁵ (45). LUR uses input from air pollution monitoring sites and geographical information on potential sources including local traffic, industrial sites and population patterns. This information is used to build a statistical model that predicts air pollution concentrations in areas where people live.³⁶⁻⁴⁰ The combination of measurements from 5,220 air monitors across 58 countries has, for example, enabled the development of a global LUR model for nitrogen dioxide air pollution⁴¹ that is being used to investigate health effects and burden of disease. LUR methods have also been applied to assign air pollution levels to the UK (Figure 8.4a) and, using historic air quality monitoring data going back to the 1970s, to study effects of air pollution on health over 30 years.⁷

***** <https://www.londonair.org.uk/LondonAir/Default.aspx>

+++++ <http://www.breathelondon.org/plan-lower-pollution-travel-route>

The application of advanced methodologies in geographic information systems (GIS) and high-performance computing, enables the capturing, storing and processing of large quantities of spatial and temporal data. This allows the modelling and assessment of exposures with complex dispersion patterns such as road traffic and aircraft noise or electromagnetic fields^{42,43} Further advances are needed to account for activity and migration patterns of people to estimate their exposure to different pollutants throughout a day, year or lifetime. Combining modelled and measurement data, for example through the joint use of satellite-derived models⁴⁴, high-precision exposure methods and information from personal monitoring devices⁴⁵, can provide high quality information on pollutant exposures for a subset of individuals that can then be extrapolated more generally to the population.

Box 2 Air quality exposure application

Dr Andrew Grieve, Kings College London

Air quality monitoring is undertaken by local authorities across the UK. The data collected is highly time resolved, quality assured and comparable across cities and regions. Although these data are collected for compliance assessment, they are increasingly being used for public dissemination and information.

The City Air app uses a combination of real-time air quality monitoring data from the London Air Quality Network (LAQN) and highly detailed dispersion modelling to provide users with air quality alerts and an innovative low pollution routing tool.

Every hour, maps for nitrogen dioxide (NO₂), PM₁₀ and PM_{2.5} particulates and ozone (O₃) are updated using the latest data from the network to create a 'Nowcast' model of air quality across the city.

Each map is highly detailed, consisting of 5.5 million 20x20 metre grid squares so this process involves the recalculation of over 10 million grid cells each hour by King's College servers.

Since the pollution concentration in each grid cell is known, the app can therefore calculate pollution concentrations along any particular route.

When provided with a start and end point, the app calculates up to three alternative routes between those points and calculates the pollution difference between the routes by summing the average of each of the pollutants in all of the grid cells that the route transects.

Using data from the LAQN, the app provides users with a range of lower pollution routes between two points thereby helping them to minimise their exposure as they travel across the city.

The application was developed by King's College London and City of London Corporation and received a Defra air quality grant in 2012.

Figure 8.4 Maps of (a) the air monitoring network and (b) modelled annual average NO₂ concentrations in London estimated by CMAQ-Urban for 2008

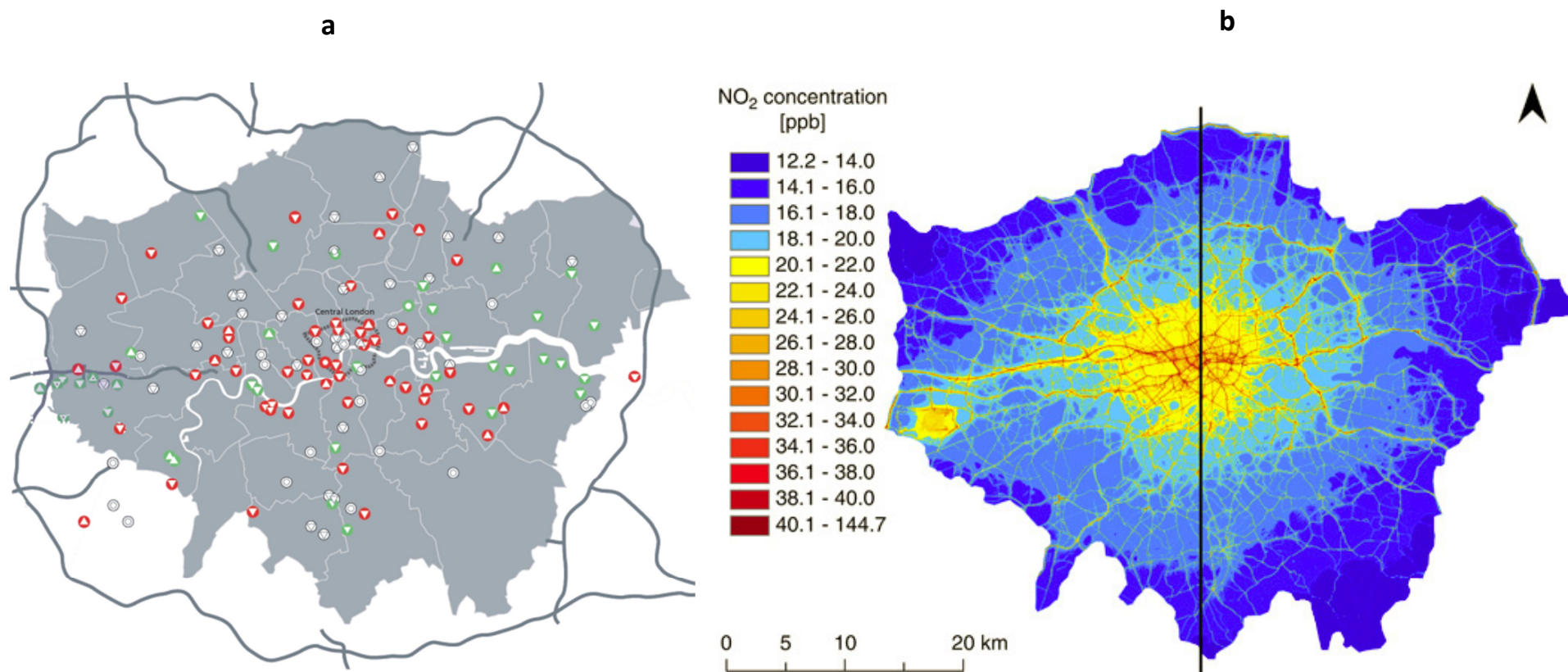

Note

1. Stations monitoring levels above and below the legal limit of 40 $\mu\text{g}/\text{m}^3$ are shown in red and green, respectively.
2. Monitoring stations with insufficient data are shown in white.
3. CMAQ-urban is a comprehensive system for modelling air quality in large urban areas, cities and towns.⁴⁶

Furthermore, new technologies of integrated micro sensors combined with smartphone applications, accurate GPS tracking and Wifi connectivity are enabling real-time crowd-sourced monitoring of a range of environmental parameters surrounding users (such as temperature, carbon monoxide, particulate matter). If widely used across the country, such devices would provide a wide network of measurements with relatively low maintenance costs. Crowd-sourcing has the potential to validate and improve modelled exposure estimates, particularly in areas of low population density and to better assess differences in health risks between individuals, based on real-time monitoring of their pollutant exposures, daily activity patterns and health. However, this will require detailed assessment of the accuracy and representativeness of such methods before they can be widely used.

Despite increasing availability of large environmental datasets, we found when compiling for SAHSU the Environment and Health Atlas for England and Wales (www.envhealthatlas.co.uk), that environmental data from different sources are collected in different ways with different access permissions (Annex 4), not all data are available nationally, while data that were available nationally were not readily available at small area level. SAHSU therefore had to carry out intensive work of data compilation and harmonisation in order to map these data at small area level nationally. In some cases, such as in an ongoing study of health risks around municipal waste incinerators³, paper records may be the only or main source of pollution data available especially if looking back in time at past exposures.

Biomarkers

The term biomarker is used to describe either a biological measure of current or historic exposure to a pollutant, or a biological measure of disease onset. A measurement of a pollutant concentration in the environment does not always correlate well with an individual's actual exposure. This may be affected by a wide range of factors including a person's daily activities, the type and location of their residence, workplace, travel and migration patterns, diet, lifestyle, medication, breathing rate as well as their genetic make-up. Biomarkers from biological samples, such as blood and urine, may allow quantification of these complex lifestyle and exposure factors at the individual level, providing data to evaluate population-level exposure models. Biomarkers can also provide information on spatio-temporal variability in exposure data and other factors that may be related both to the exposures and health outcomes (i.e., confounders). Use of biomarkers can therefore lead to improved risk estimates of health effects of pollution by providing better estimates of exposure, thus reducing measurement errors and other sources of bias and strengthening possible causal inferences.⁴⁷

In a number of countries, nationally representative surveys have been set up to collect and store health information and biological samples that can be used to investigate biomarkers of environmental risks and to monitor how the health of the national population changes over time. One of the earliest such surveys is the United States National Health and Nutrition Examination Survey *****(NHANES), which began in the 1960s and tests thousands of individual samples for hundreds of chemical exposures, allowing the investigation of biomarkers of environmental exposure and disease, as well as population surveillance of exposures to multiple pollutants⁴⁸ (Box 3). Biological samples from NHANES were, for example, instrumental in generating biomonitoring data on heavy metal concentrations such as lead^{49,50}, cadmium⁵¹ and manganese.⁵² Some countries, such as Germany, have gone a step further by creating an environmental specimen bank^{§§§§§§§§§§} to permanently archive ecological and toxicological evidence of current and past pollutant exposures allowing detailed retrospective investigations.^{53,54}

***** https://www.cdc.gov/nchs/nhanes/about_nhanes.htm
§§§§§§§§§§ <https://www.umweltprobenbank.de/>

The UK government funds the annual Health Survey for England (HSE), which has collected data since the early 90s, on physical health, mental health and wellbeing, social care, lifestyle behaviours based on interviews, as well as physical measures (height, weight and blood pressure) from around 8,000 adults and 2,000 children per survey, who are representative of the general population.^{*****} HSE data allow the monitoring of changes in health and lifestyles (e.g. alcohol drinking, smoking), and the prevalence of specific health conditions, as well as being used to plan services and develop and evaluate public health policies. In recent years, HSE has also collected saliva, blood and urine samples for assessment of, for example, cardiovascular risk (e.g. cholesterol) and diabetes. HSE has to date been little used for studies on health effects of pollution, though the collection and storage of biological samples and health data mean that such studies using HSE data could be undertaken were funding to become available.

Box 3 The National Health and Nutrition Examination Survey (NHANES)

NHANES (<https://www.cdc.gov/nchs/nhanes/index.htm>) is a programme of national studies in the USA, managed by the Centres for Disease Prevention and Control (CDC), and designed to assess the health and nutritional status of adults and children in the United States through interviews (including demographic, socioeconomic, dietary, and health-related questions), physical examinations (medical, dental, and physiological measurements) and biological samples (blood and urine). NHANES includes data on a range of medical conditions (e.g. anaemia, cardiovascular disease, diabetes, eye diseases, hearing loss) as well as on environmental exposures, physical fitness and physical functioning.

The fifty years of data from NHANES provide a remarkable resource to monitor temporal trends in pollutant levels and disease risk factors through direct measurements. Some of the main achievements of NHANES are the development of new policies to eliminate lead from petrol in the US as well as in many other parts of the world; the development of growth curves and monitoring of obesity; the implementation of a national education programme to reduce hypertension and cholesterol levels. NHANES has been used, for example, to investigate the potential effects of urinary bisphenol A (found in plastics) on diabetes, cardiovascular disease and liver function⁵⁵, and data from NHANES have been 'mined' to explore effects of a wide range of exposures on health.⁵⁶ The value of NHANES data is further increased by being made accessible to users and researchers throughout the world.

^{*****} (<http://content.digital.nhs.uk/healthsurveyengland>)

Public Health England is leading for the UK in the European Human Biomonitoring Initiative (HBM4EU), a joint effort of 26 countries funded by the European Commission to coordinate and advance biomonitoring in Europe, which launched in 2016. This presents an opportunity to create an ongoing national resource similar to NHANES, possibly linked to HSE, to monitor pollution exposures in the general population. These could include both well-known contaminants, such as lead and dioxin-like chemicals, as well as newer chemicals such as flame retardants and those with endocrine disrupting properties. Such an initiative would provide a rich source of information on people's exposure to pollution and be an invaluable resource for studies of environmental hazards and health that could both inform public health policies and help assess the benefits of policy changes over time.

In addition, biological samples are collected in large national (e.g. UK Biobank) or local (e.g. the Avon Longitudinal Study of Parents and Children⁵⁷) studies, which offer opportunities to identify biomarkers of major chronic diseases, as well as for analyses of environmental contaminants in stored samples. Linkage of such data on individuals with small area data, often called "mixed design" studies, presents new opportunities to better understand the associations between pollutant exposures and health.^{3,11,58-61}

Health data

Good quality data on health outcomes as well as pollution exposures are crucial to investigate the impact of pollution on health. The volume and accessibility of health records in England, collected mainly for the purposes of delivering and auditing healthcare throughout the NHS, have dramatically increased in the last two to three decades. For example, on average over 100 million individual records from outpatient, maternity, adult critical care and accident and emergency (A&E) services across all NHS hospitals are added every year to the Health Episode Statistics (HES, <http://content.digital.nhs.uk/hes>) database. A remarkable feature of NHS data in England and throughout the UK is the near universal coverage which allows investigation of environment and health associations in neighbourhoods and local areas for any part of the country.^{3,12,62}

In addition to routinely collected health data, around 3.5% of the UK general population - 2.2 million people - participate in ongoing long-term health studies (cohort studies) following people over time to investigate risk factors among people who do or do not develop disease. The largest of these cohort studies is UK Biobank, mentioned above, which includes over 500,000 individuals with clinical measurements, demographic and health data and blood, urine and saliva samples stored for assessment of biomarkers.⁶³

There has also been an explosion of data collected by individuals through use of smartphone technology and personal monitoring devices, including heart rate, physical activity, sleep patterns, calorie consumption and other health indicators. Such devices collect information in real-time at short intervals, potentially over long-periods of time, accessible to each individual user but also collectively to the device manufacturers (and potentially to researchers). These emerging data sources provide yet largely untapped information on health behaviours of many thousands of people at low cost.⁶⁴

However, just because health data are collected does not mean that they can be used in research on health effects of pollution or for health surveillance. For example, their quality, coverage or completeness may not be suitable for health analysis (Box 4), they may have restricted access or usage, or it may be difficult to link them together with pollutant data. Issues of data harmonisation and linkage also apply to cohort studies and biobanks. Initiatives, such as the Cohort & Longitudinal Studies Enhancement Resources (CLOSER, <http://www.closer.ac.uk/>), are working to harmonise longitudinally collected data from UK cohorts. The European Union funded BioSHaRE project (<http://www.bioshare.eu/>) (2010-15) helped develop methods to harmonise and combine data collected in large European biobanks including UK Biobank⁶⁵ and to advance data analysis techniques.⁶ Lessons learned

from such initiatives could help in integrating and harmonising data from newly emerging sources.

Box 4 Selected examples of challenges for research related to the use of routinely collected health data in England

1. Birth data are collected in four different databases in England, each having differing strengths and weaknesses.⁶⁶ Careful assessment of the quality and completeness of each database and their overlap is needed for use in studies of environment and health and for surveillance.
2. Cancer registrations used to be collected in seven regional cancer registries with slightly different coding practices that led in the past to apparent differences in regional incidence and trends for some cancers. There is now a unified cancer registration system for England led by Public Health England: the National Cancer Registration and Analysis Service (NCRAS). This registry records over 300,000 cases of cancer per year (<https://www.gov.uk/guidance/national-cancer-registration-and-analysis-service-ncras>) using the same methods and can be used to monitor geographical and time trends.
3. Until now, registries of congenital anomalies were managed at the regional level and did not cover the whole of England.⁶⁷ The recent creation of a National Congenital Anomaly and Rare Disease Registration Service (NCARDRS, <https://www.gov.uk/guidance/the-national-congenital-anomaly-and-rare-disease-registration-service-ncardrs>) for England will greatly facilitate studies of anomalies, an important sentinel for environmental risks.^{68,69}
4. Demonstrating responsible handling of personal data, including data privacy and good information governance is important, e.g. ensuring that outputs comply to confidentiality rules (suppression of low number in a small area) to reassure patients that their data is not identifiable.
5. An increasing proportion of NHS patients in England are opting out of the use of their health records beyond their GP practice or the NHS system (<http://content.digital.nhs.uk/article/7092/Information-on-type-2-opt-outs>). Although the overall rate of such opt-outs is quite low, gaps in the data are highly clustered which can create problems when conducting studies of environmental hazards and risks to health, particularly at the small area level.

Data methods, linkage and analysis

Rigorous protocols are necessary to share, link and analyse health and pollution data in a timely fashion.⁵⁸ Combining information from different data sources can provide important insights into the effects of pollution on health, but complex administrative procedures often mean researchers have delays of months or years in accessing and compiling the data, requiring approvals from multiple data providers. The creation of Health Data Research UK (HDR UK, <https://www.mrc.ac.uk/about/institutes-units-centres/uk-institute-for-health-and-biomedical-informatics-research/>), bringing together a consortium of world-leading groups in health and biomedical informatics should facilitate ready access to and use of large patient and research data sets, while ensuring compliance with information governance regulations.

Efficient statistical methods and software are needed to process, analyse and visualise the data. Use of dedicated analytical software can considerably reduce the time required by a researcher or a public health professional to investigate potential health risks to the public. The Rapid Inquiry Facility (RIF), developed by SAHSU, supports disease mapping and risk analysis for environmental health studies, especially those in the vicinity of industrial sites or other sources of environmental pollution (Box 5), allowing the rapid analysis and dissemination of results.

Data quality checks are essential when compiling and processing environment, health and socioeconomic and biomarker data to avoid gaps in the data or interpreting errors rather than real signals of public health significance.⁷⁰ Misclassification can occur due to inaccuracies in the location of cases and populations, potentially diluting true associations or introducing spurious temporal or spatial patterns in risk.⁷¹ Studies of small numbers of individuals or those conducted at small area level are more prone to errors or local variations in the quality of both the health (numerator) and the population (denominator) data than studies conducted over larger areas. Health risks are often mapped to relatively arbitrary administrative areas. Grouping data at different levels of spatial resolution (e.g., wards, census tracts, regions) or aggregating data to different areal arrangements will lead to variation in the results and may affect the interpretation and generalisability of the findings.⁵⁸

Box 5 The Rapid Inquiry Facility - RIF 4.0

The Rapid Inquiry Facility (RIF) provides a powerful tool to link and evaluate spatial relationships between different data sources, to explore and visualise the data through disease mapping and to calculate health risks in relation to sources of environmental pollution (26, 81). It can dramatically speed up data analysis and public health inquiries such as those to investigate potential disease clusters. The current version of the RIF (4.0) integrates advanced methods in statistics, exposure assessment and data visualisation. It is based on open-source software integrated with the statistical package *R* with the ability to read in local sources of environment and health data for data analysis.

Surveillance

Public health surveillance mechanisms are well established for infectious disease in England and in most other countries worldwide to detect outbreaks and inform prevention measures. Similar mechanisms for surveillance of non-communicable diseases (NCDs) or for health risks from environmental factors (environmental public health tracking) in England are still in development stage (Box 6), despite NCDs being a larger public health issue.^{72,73} One of the best established environmental public health tracking (EPHT) systems worldwide is in the USA (Box 8), which provides timely, accurate and systematic pollution data to both public and public health decision makers.

NCD surveillance in England needs further investment to help develop strategies for prevention and for detection and treatment of those already affected. Surveillance of exposure to pollutants that contribute to NCDs and reliably detecting spatio-temporal signals in NCDs data (e.g., 'clusters', peaks or unusual trends) rely both on high-quality data⁷⁴ and on use of advanced statistical methods.⁷⁵ Being able to detect areas of potentially high risk of specific NCDs requires methods that display both specificity (few false positive findings) and sensitivity (high ability to detect true positives). Apparent local clusters of disease may, after investigation, indicate areas with higher-quality data registration or areas where there are many duplicate registrations. Results from an epidemiological study might only apply to a certain portion of the population based on, for example, the size of the study area, the nature of the environmental risks, the local socio-economic context. Differentiating real signals from false positive ones is therefore an important methodological challenge. Surveillance of chronic diseases has so far mostly focused on specific conditions (e.g. hepatic angiosarcoma⁷⁶, mesothelioma⁷⁷, leukaemia,⁷⁸), rather than on a generic approach to detecting excesses or anomalies in the data. Emerging methods, such as BaySDetect¹⁹, along with machine learning and other computing intensive data science methods, offer potential to carry out such analyses using a systematic approach. Potentially, such methods could be applied to the national health datasets on an on-going basis, to provide early warning of any untoward trends in the data.

Box 6 Environmental Public Health Tracking in England

Helen Crabbe, Environmental Epidemiology Group, CRCE, Public Health England

Public Health England (PHE) has a programme of Environmental Public Health Tracking (EPHT) much like the US CDC (Box 8).

Environmental Public Health Tracking (EPHT) has been defined by the US Centers for Disease Control and Prevention as: "The ongoing collection, integration, analysis, and interpretation of data about environmental hazards, exposure to environmental hazards and human health effects potentially related to exposure to environmental hazards. It includes dissemination of information learned from these data."ⁱ EPHT can provide timely, accurate and systematic environmental data to public health decision makers on how to reduce the environmental health burden. By effectively linking environmental health data and translating it into meaningful information, EPHT can help protect the health of the public.

PHE's EPHT programme aims to explore and develop a methodology for addressing environmental hazards that delivers integrated, local and national surveillance of those hazards, exposure assessment and relating health effects of environmental exposures to those hazards. This provides evidence of the health burden represented by such hazards and exposures, informs responses to new exposures, and supports the ongoing development of environmental epidemiology, toxicology and exposure science.

Within this remit, PHE has developed an environmental public health surveillance system (EPHSS)ⁱⁱ, which facilitates collection and collation of environmental hazard and health outcome data. The component parts encapsulate:

- Hazard identification and mapping;
- Exposure assessment and quantification;
- Development of bio-monitoring;
- Systematic review of health outcomes and disease surveillance;
- Horizon scanning;
- Development of environment and health indicators.

The tracking programme builds on the experience and expertise developed through the design and operation of related systems currently used by PHE and other government agencies. The programme aims to benchmark best practices in environmental surveillance. It exploits elements of existing national non-infectious environmental and chemical incidents surveillance systems in England, Wales and Scotland. The developing EPHSS is currently being built to capture information on environmental hazards, exposures and related health outcomes.

PHE's Tracking programme started in 2010 with two proof of concept projects. A 'Hazard tracking' project explored exposure to chemicals (especially arsenic) through drinking water from Private Water Supplies (PWS). 500 PWS were tested for arsenic and other chemicals and biomonitoring confirmed exposure to arsenic through this route. PHE worked with the British Geological Survey and the University of Manchester to characterise exposures and develop a geological based hazard model to estimate risks to health. An 'Outcome tracking' project involved characterising the burden of disease from Carbon Monoxide (CO) poisoning. The project aims to quantify the effects of CO exposure, on accidental deaths, hospital visits and admissions, GP consultations and effects in the community. PHE has been working with the Coroner's Office to better understand causes of accidental deaths involving CO.

More recently PHE's Tracking programme has worked with over 200 stakeholders to develop EPHT in England over the last few years and is actively delivering on a few topics; e.g. developing a prioritisation tool to support local authorities Environmental Public Health interventions, public health impacts of fluoridation of public water supplies, set up and development of an International Network on Public Health and Environment Tracking (INPHET)ⁱⁱⁱ, developing guidance for investigating non-infectious disease clusters or environmental exposures with unknown health consequences, and implementing surveillance systems for Lead Exposures in Children.

PHE is currently consulting on its National Environmental Public Health Strategy with stakeholders. Its' vision is to provide a service to enhance understanding of the health effects of environmental exposures and provide expert advice and support to public health practitioners and the public in minimising the effects of the environment on health. The tracking programme is well placed to provide data and evidence and the systems to measure success.

- i US CDC Environmental Public Health Tracking: <http://www.cdc.gov/nceh/tracking/>
- ii <https://www.gov.uk/government/publications/environmental-public-health-surveillance-system/environmental-public-health-surveillance-system-ephss>
- iii INPHET: <http://www.epiprev.it/INPHET/home>

Box 7 Health and Occupation Research (THOR) surveillance network and environmental surveillance

'Stressors' often first occur in the workplace, where the same environmental contaminants are present at concentrations or intensities which are orders of magnitude higher than in the general environment. As an example, we recently observed an increase in incidence of occupational dermatitis attributed to isothiazolinones (MI/MCI), particularly in healthcare and beauty workers. MI/MCI were present (as preservatives) in many personal care products so environmental exposure was highly likely. The observations from THOR data strengthened the evidence for the subsequent EU regulation banning the use of MI/MCI in leave-on cosmetics from 2016/2017.

THOR could provide the platform for public health surveillance, particularly of chemical exposures. Reported cases are routinely screened to identify new/emerging hazards (e.g. novel causes or workplaces, unusual clusters etc). For example, we recently observed increased reports of chemical pneumonitis in marine engineers attributed to waterproofing spray (the same substance is used to waterproof shoes so environmental exposure is likely). Additionally, methodologies developed and improved over time within THOR, for example to determine incidence, trends in incidence and to evaluate change in incidence due to specific interventions, could be applied to non-occupational disease reporting to determine population estimates due to environmental exposures and to identify new chemical hazards.

A main advantage of capturing environmental exposures through the THOR network is that a well-established structure is already in place, thus ensuring an efficient use of an existing UK resource. THOR is composed of several different reporting schemes (e.g. for chest physicians, dermatologists, occupational physicians, GPs) and across all the schemes we currently have approximately 900 reporting physicians, with in excess of 111,000 cases reported to date. Initial discussions with key THOR reporters have indicated an interest and a willingness to consider widening their reporting to include non-occupational exposures. Central to the longevity and success of THOR (the first scheme commenced data collection in 1989) is the loyalty of the participating physicians, facilitated by an excellent rapport with the medical community in general and with the individual reporters themselves (including extensive feedback/benefits, including CPD, for participating).

Source

Carder M, Hussey L, Money A, Gittins M, McNamee R, Stock SJ, Sen D, Agius RM. The Health and Occupation Research Network (THOR) - an evolving surveillance system. SHAW 2017; 8(3):231-236

Box 8 Environmental Public Health Tracking in the US

Capt. Fuyuen Yip and Ms. Holly Wilson, Centers for Disease Control and Prevention; Dr. Wendy McKelvey, New York City Department of Health and Mental Hygiene

In September 2000, the Pew Environmental Health Commission issued a report stating that public health agencies in the United States lacked capacity to evaluate and conduct key investigations into the status of the health of their environment (84). The Commission found that information on non-infectious diseases was not routinely collected; environmental hazard monitoring and data collection were conducted for regulatory purposes, not public health; and, very little data existed with respect to human exposures to environmental hazards.

In 2002, in response to the Pew report, Congress appropriated funds to the Centers for Disease Control and Prevention (CDC), under the leadership of the National Environmental Public Health Tracking Program, to develop an environmental public health tracking network (Tracking Network) that would monitor the burden from environmentally related disease and help fill in the data gaps.

One of the environmental hazards that the Tracking Program focuses on is outdoor air pollution. To better understand how air pollution affects health, CDC's Tracking Network displays air pollution data on ozone and particulate matter (PM_{2.5}) from the U.S. Environmental Protection Agency (EPA) (<https://ephtracking.cdc.gov/showAirLanding.action>). EPA's data come from approximately 4,000 monitoring stations around the country, mainly in urban areas. While these data are considered the "gold standard" for determining outdoor air pollution, they are limited in geographic and temporal scope. CDC and EPA have worked together to develop a statistical model to make modelled predictions available for environmental public health tracking purposes in areas of the country that do not have monitors and to fill in the time gaps when monitors may not be recording data. State and local health departments funded by the CDC National Tracking Program are working to fill data gaps.

continues next page

An example of how this approach has been used to prevent ill-health due to pollution comes from New York. The New York City Department of Health and Mental Hygiene, a CDC-funded tracking program partnered with Queens College of the City University of New York to conduct the New York City Community Air Survey (NYCCAS). The survey monitors variation in air pollution levels across the city and looks at how local sources of air pollution (e.g., vehicles and building boilers) contribute to the variation.⁷⁹ The NYCCAS showed that higher levels of PM2.5 were measured in areas with the highest densities of oil-burning boilers. Health impact analyses suggested that many hospital visits and deaths could be prevented by reducing PM2.5 emissions generated by burning heating oil. NYC leaders used the findings to support a local law, enacted in 2010, and regulations, finalized in 2011, to phase out use of the most polluting heating oil in NYC.⁸⁰ Once the clean heating oil policies are fully implemented, it is estimated that lower PM2.5 levels will prevent an estimated 300 deaths in NYC each year.⁸¹

Conclusions

The burden of NCDs in England is increasing, reflecting the ageing of the population.⁸² Epidemiological evidence to identify risks to health, including from environmental pollutants, is fundamental to help prevent future complications and high-costs associated with the occurrence and management of these diseases. This relies on the availability of high-quality data and on close partnerships between government, public health and academic institutions, as illustrated by the work conducted by SAHSU over the last thirty years. As environmental risks to health affect populations worldwide, there is enormous potential for UK researchers and public health specialists to share their world-leading expertise in this field. This would include building local capacity to support the collection of appropriate data to study the impact of environmental factors on the health of local populations, particularly in low- and middle-income countries.

Box 9 What can be done?

The surveillance of non-communicable disease and environmental public health tracking should be given the same legal and ethical protections as control of infectious disease, including full access to health and other data for this specific purpose. Further investment is needed to fully develop methods and systems.

A population biomarker panel would greatly help monitoring of personal exposure to chemicals and other pollutants that cannot be monitored by other means – i.e. NHANES for the UK – using for example, Health Survey for England, UK Biobank and British birth cohorts.

Sustained infrastructure support and funding from governmental and research funders such as UK Research and Innovation (UKRI) are essential to conduct reliable and high-quality studies into the health effects of environmental pollution for the benefit of the population of England and the world. An efficient way forward would be to use ongoing programmes and build on the initiatives where government is already providing funding for such infrastructure such as the Health Survey for England.

References

1. Rose G. Sick individuals and sick populations. *International Journal of Epidemiology*. 2001;30(3):427-32.
2. Elliott P, Briggs D, Morris S, de Hoogh C, Hurt C, Jensen TK, et al. Risk of adverse birth outcomes in populations living near landfill sites. *BMJ (Clinical research ed)*. 2001;323(7309):363-8.
3. Douglas P, Freni-Sterrantino A, Leal Sanchez M, Ashworth DC, Ghosh RE, Fecht D, et al. Estimating Particulate Exposure from Modern Municipal Waste Incinerators in Great Britain. *Environmental science & technology*. 2017;51(13):7511-9.
4. Aylin P, Morris S, Wakefield J, Grossinho A, Jarup L, Elliott P. Temperature, housing, deprivation and their relationship to excess winter mortality in Great Britain, 1986-1996. *Int J Epidemiol*. 2001;30(5):1100-8.
5. Bennett JE, Blangiardo M, Fecht D, Elliott P, Ezzati M. Vulnerability to the mortality effects of warm temperature in the districts of England and Wales. *Nature Clim Change*. 2014;4(4):269-73.
6. Cai Y, Zijlema WL, Doiron D, Blangiardo M, Burton PR, Fortier I, et al. Ambient air pollution, traffic noise and adult asthma prevalence: a BioSHaRE approach. *The European respiratory journal*. 2017;49(1).
7. Hansell A, Ghosh RE, Blangiardo M, Perkins C, Vienneau D, Goffe K, et al. Historic air pollution exposure and long-term mortality risks in England and Wales: prospective longitudinal cohort study. *Thorax*. 2016.
8. Nieuwenhuijsen MJ, Martinez D, Grellier J, Bennett J, Best N, Iszatt N, et al. Chlorination disinfection by-products in drinking water and congenital anomalies: review and meta-analyses. *Environmental health perspectives*. 2009;117(10):1486-93.
9. Toledano MB, Nieuwenhuijsen MJ, Best N, Whitaker H, Hambly P, de Hoogh C, et al. Relation of trihalomethane concentrations in public water supplies to stillbirth and birth weight in three water regions in England. *Environmental health perspectives*. 2005;113(2):225-32.
10. Dolk H, Shaddick G, Walls P, Grundy C, Thakrar B, Kleinschmidt I, et al. Cancer Incidence near Radio and Television Transmitters in Great Britain I. Sutton Coldfield Transmitter. *Amer J Epi*. 1997;145(1):1-9.
11. Elliott P, Shaddick G, Douglass M, de Hoogh K, Briggs DJ, Toledano MB. Adult cancers near high-voltage overhead power lines. *Epidemiology*. 2013;24(2):184-90.
12. Elliott P, Toledano MB, Bennett J, Beale L, de Hoogh K, Best N, et al. Mobile phone base stations and early childhood cancers: case-control study. *BMJ (Clinical research ed)*. 2010;340.
13. Briggs D, Abellan JJ, Fecht D. Environmental inequity in England: Small area associations between socio-economic status and environmental pollution. *Soc Sci Med*. 2008;67(10):1612-29.

14. Bennett JE, Li G, Foreman K, Best N, Kontis V, Pearson C, et al. The future of life expectancy and life expectancy inequalities in England and Wales: Bayesian spatiotemporal forecasting. *The Lancet*.386(9989):163-70.
15. Fecht D, Jones A, Hill T, Lindfield T, Thomson R, Hansell AL, et al. Inequalities in rural communities: adapting national deprivation indices for rural settings. *J Public Health (Oxf)*. 2017:1-7.
16. Fecht D, Fischer P, Fortunato L, Hoek G, de Hoogh K, Marra M, et al. Associations between air pollution and socioeconomic characteristics, ethnicity and age profile of neighbourhoods in England and the Netherlands. *Environmental pollution (Barking, Essex : 1987)*. 2015;198:201-10.
17. Gulliver J, Morris C, Lee K, Vienneau D, Briggs D, Hansell A. Land use regression modeling to estimate historic (1962-1991) concentrations of black smoke and sulfur dioxide for Great Britain. *Environmental science & technology*. 2011;45(8):3526-32.
18. Beelen R, Hoek G, Vienneau D, Eeftens M, Dimakopoulou K, Pedeli X, et al. Development of NO₂ and NO_x land use regression models for estimating air pollution exposure in 36 study areas in Europe – The ESCAPE project. *Atmos Environ*. 2013;72:10-23.
19. Eeftens M, Beelen R, de Hoogh K, Bellander T, Cesaroni G, Cirach M, et al. Development of Land Use Regression models for PM_{2.5}, PM_{2.5} absorbance, PM₁₀ and PM_{coarse} in 20 European study areas; results of the ESCAPE project. *Environmental science & technology*. 2012;46(20):11195-205.
20. de Hoogh K, Wang M, Adam M, Badaloni C, Beelen R, Birk M, et al. Development of land use regression models for particle composition in twenty study areas in Europe. *Environmental science & technology*. 2013;47(11):5778-86.
21. Gulliver J, de Hoogh K, Hansell A, Vienneau D. Development and back-extrapolation of NO₂ land use regression models for historic exposure assessment in Great Britain. *Environmental science & technology*. 2013;47(14):7804-11.
22. Briggs DJ, Gulliver J, Fecht D, Vienneau DM. Dasymeric modelling of small-area population distribution using land cover and light emissions data. *Remote Sensing of Environment*. 2007;108(4):451-66.
23. Briggs D, Beale L, Bennett J, Toledano MB, de Hoogh K. A geographical model of radio-frequency power density around mobile phone masts. *The Science of the total environment*. 2012;426:233-43.
24. Nieuwenhuijsen MJ, Toledano MB, Bennett J, Best N, Hambly P, de Hoogh C, et al. Chlorination disinfection by-products and risk of congenital anomalies in England and Wales. *Environmental health perspectives*. 2008;116(2):216-22.
25. Morley DW, de Hoogh K, Fecht D, Fabbri F, Bell M, Goodman PS, et al. International scale implementation of the CNOSSOS-EU road traffic noise prediction model for epidemiological studies. *Environmental pollution (Barking, Essex : 1987)*. 2015;206:332-41.

26. Aylin P, Maheswaran R, Wakefield J, Cockings S, Jarup L, Arnold R, et al. A national facility for small area disease mapping and rapid initial assessment of apparent disease clusters around a point source: the UK Small Area Health Statistics Unit. *J Public Health Med.* 1999;21(3):289-98.
27. Black D. Investigation of the possible increased incidences of cancer in West Cumbria. London, United Kingdom: Her Majesty's Stationary Office; 1984.
28. Li G, Best N, Hansell AL, Ahmed I, Richardson S. BaySTDetect: detecting unusual temporal patterns in small area data via Bayesian model choice. *Biostatistics (Oxford, England).* 2012;13(4):695-710.
29. Papageorgiou G, Richardson S, Best N. Bayesian non-parametric models for spatially indexed data of mixed type. *Journal of the Royal Statistical Society: Series B (Statistical Methodology).* 2015;77(5):973-99.
30. Gulliver J, Morley D, Vienneau D, Fabbri F, Bell M, Goodman P, et al. Development of an open-source road traffic noise model for exposure assessment. *Environmental Modelling & Software.* 2015;74:183-93.
31. Morley DW, Gulliver J. Methods to improve traffic flow and noise exposure estimation on minor roads. *Environmental pollution (Barking, Essex : 1987).* 2016;216:746-54.
32. Government Office for Science. Blackett Review on wide-area biological detection. Available from <http://epubs.surrey.ac.uk/805211/>. 2014. Report No.: URN 14/590.
33. The Caldicott Committee. Report on the Review of Patient-Identifiable Information. Department of Health; 1997.
34. Taylor P. Caldicott 2 and patient data. *British Medical Journal* 2013;346.
35. Caldicott F. National Data Guardian for Health and Care: Review of data security, consent and opt-out. 2016.
36. Lea NC, Nicholls J, Dobbs C, Sethi N, Cunningham J, Ainsworth J, et al. Data Safe Havens and Trust: Toward a Common Understanding of Trusted Research Platforms for Governing Secure and Ethical Health Research. *JMIR Medical Informatics.* 2016;4(2):e22.
37. Richardson S, Best N. Bayesian hierarchical models in ecological studies of health–environment effects. *Environmetrics.* 2003;14(2):129-47.
38. Mooney SJ, Westreich DJ, El-Sayed AM. Commentary: Epidemiology in the era of big data. *Epidemiology.* 2015;26(3):390-4.
39. Wild CP. Complementing the genome with an "exposome": the outstanding challenge of environmental exposure measurement in molecular epidemiology. *Cancer epidemiology, biomarkers & prevention : a publication of the American Association for Cancer Research, cosponsored by the American Society of Preventive Oncology.* 2005;14(8):1847-50.
40. Vineis P, van Veldhoven K, Chadeau-Hyam M, Athersuch TJ. Advancing the application of omics-based biomarkers in environmental epidemiology. *Environmental and Molecular Mutagenesis.* 2013;54(7):461-7.
41. Stingone JA, Buck Louis GM, Nakayama SF, Vermeulen RC, Kwok RK, Cui Y, et al. Toward Greater Implementation of the Exposome Research

- Paradigm within Environmental Epidemiology. Annual review of public health. 2017;38:315-27.
42. Rappaport SM, Smith MT. Epidemiology. Environment and disease risks. Science. 2010;330.
 43. Ellis JK, Athersuch TJ, Thomas LD, Teichert F, Pérez-Trujillo M, Svendsen C, et al. Metabolic profiling detects early effects of environmental and lifestyle exposure to cadmium in a human population. BMC Medicine. 2012;10(1):61.
 44. Chatziioannou A, Georgiadis P, Hebels DG, Liampa I, Valavanis I, Bergdahl IA, et al. Blood-based omic profiling supports female susceptibility to tobacco smoke-induced cardiovascular diseases. Scientific reports. 2017;7:42870.
 45. Briggs DJ, de Hoogh C, Gulliver J, Wills J, Elliott P, Kingham S, et al. A regression-based method for mapping traffic-related air pollution: application and testing in four contrasting urban environments. The Science of the total environment. 2000;253(1):151-67.
 46. Briggs DJ, Collins S, Elliott P, Fischer P, Kingham S, Lebret E, et al. Mapping urban air pollution using GIS: a regression-based approach. Int J Geogr Inf Sci. 1997;11(7):699-718.
 47. Gulliver J, de Hoogh K, Fecht D, Vienneau D, Briggs D. Comparative assessment of GIS-based methods and metrics for estimating long-term exposures to air pollution. Atmospheric Environment. 2011;45(39):7072-80.
 48. Hoek G, Beelen R, de Hoogh K, Vienneau D, Gulliver J, Fischer P, et al. A review of land-use regression models to assess spatial variation of outdoor air pollution. Atmospheric Environment. 2008;42(33):7561-78.
 49. de Hoogh K, Korek M, Vienneau D, Keuken M, Kukkonen J, Nieuwenhuijsen MJ, et al. Comparing land use regression and dispersion modelling to assess residential exposure to ambient air pollution for epidemiological studies. Environ Int. 2014;73:382-92.
 50. Lee M, Brauer M, Wong P, Tang R, Tsui TH, Choi C, et al. Land use regression modelling of air pollution in high density high rise cities: A case study in Hong Kong. Science of The Total Environment. 2017;592:306-15.
 51. Larkin A, Geddes JA, Martin RV, Xiao Q, Liu Y, Marshall JD, et al. Global Land Use Regression Model for Nitrogen Dioxide Air Pollution. Environmental science & technology. 2017;51(12):6957-64.
 52. Halonen JI, Hansell AL, Gulliver J, Morley D, Blangiardo M, Fecht D, et al. Road traffic noise is associated with increased cardiovascular morbidity and mortality and all-cause mortality in London. European heart journal. 2015;36(39):2653-61.
 53. Hansell AL, Blangiardo M, Fortunato L, Floud S, de Hoogh K, Fecht D, et al. Aircraft noise and cardiovascular disease near Heathrow airport in London: small area study. BMJ : British Medical Journal. 2013;347.
 54. de Hoogh K, Gulliver J, Donkelaar AV, Martin RV, Marshall JD, Bechle MJ, et al. Development of West-European PM2.5 and NO2 land use regression models incorporating satellite-derived and chemical transport modelling data. Environmental research. 2016;151:1-10.

55. Moore E, Chatzidiakou L, Jones RL, Smeeth L, Beevers S, Kelly FJ, et al. Linking e-health records, patient-reported symptoms and environmental exposure data to characterise and model COPD exacerbations: protocol for the COPE study. *BMJ Open*. 2016;6(7):e011330.
56. Beevers SD, Kitwiroon N, Williams ML, Kelly FJ, Ross Anderson H, Carslaw DC. Air pollution dispersion models for human exposure predictions in London. *J Expos Sci Environ Epidemiol*. 2013;23(6):647-53.
57. Sobus JR, DeWoskin RS, Tan YM, Pleil JD, Phillips MB, George BJ, et al. Uses of NHANES Biomarker Data for Chemical Risk Assessment: Trends, Challenges, and Opportunities. *Environmental health perspectives*. 2015;123(10):919-27.
58. Tsoi MF, Cheung CL, Cheung TT, Cheung BM. Continual Decrease in Blood Lead Level in Americans: United States National Health Nutrition and Examination Survey 1999-2014. *The American journal of medicine*. 2016;129(11):1213-8.
59. Mahaffey KR, Annet JL, Roberts J, Murphy RS. National Estimates of Blood Lead Levels: United States, 1976–1980. *New England Journal of Medicine*. 1982;307(10):573-9.
60. Riederer AM, Belova A, George BJ, Anastas PT. Urinary cadmium in the 1999-2008 U.S. National Health and Nutrition Examination Survey (NHANES). *Environmental science & technology*. 2013;47(2):1137-47.
61. Oulhote Y, Mergler D, Bouchard MF. Sex- and age-differences in blood manganese levels in the U.S. general population: national health and nutrition examination survey 2011-2012. *Environmental health : a global access science source*. 2014;13:87.
62. Schroter-Kermani C, Muller J, Jurling H, Conrad A, Schulte C. Retrospective monitoring of perfluorocarboxylates and perfluorosulfonates in human plasma archived by the German Environmental Specimen Bank. *International journal of hygiene and environmental health*. 2013;216(6):633-40.
63. Moos RK, Apel P, Schroter-Kermani C, Kolossa-Gehring M, Bruning T, Koch HM. Daily intake and hazard index of parabens based upon 24 h urine samples of the German Environmental Specimen Bank from 1995 to 2012. *Journal of exposure science & environmental epidemiology*. 2016.
64. Lang IA, Galloway TS, Scarlett A, et al. Association of urinary bisphenol a concentration with medical disorders and laboratory abnormalities in adults. *JAMA*. 2008;300(11):1303-10.
65. Patel CJ, Bhattacharya J, Butte AJ. An Environment-Wide Association Study (EWAS) on type 2 diabetes mellitus. *PloS one*. 2010;5(5):e10746.
66. Golding J. Children of the nineties. A longitudinal study of pregnancy and childhood based on the population of Avon (ALSPAC). *West of England medical journal*. 1990;105(3):80-2.
67. Elliott P, Wartenberg D. Spatial Epidemiology: Current Approaches and Future Challenges. *Environmental health perspectives*. 2004;112(9):998-1006.

68. Chang ET, Adami H-O, Bailey WH, Boffetta P, Krieger RI, Moolgavkar SH, et al. Validity of geographically modeled environmental exposure estimates. *Crit Rev Toxicol*. 2014;44(5):450-66.
69. Leroux BG, Lei X, Breslow N. Estimation of Disease Rates in Small Areas: A new Mixed Model for Spatial Dependence. In: Halloran ME, Berry D, editors. *Statistical Models in Epidemiology, the Environment, and Clinical Trials*. New York, NY: Springer New York; 2000. p. 179-91.
70. Berkowitz Z, Zhang X, Richards TB, Peipins L, Henley SJ, Holt J. Multilevel Small-Area Estimation of Multiple Cigarette Smoking Status Categories Using the 2012 Behavioral Risk Factor Surveillance System. *Cancer epidemiology, biomarkers & prevention : a publication of the American Association for Cancer Research, cosponsored by the American Society of Preventive Oncology*. 2016;25(10):1402-10.
71. Elliott P, Richardson S, Abellan JJ, Thomson A, de Hoogh C, Jarup L, et al. Geographic density of landfill sites and risk of congenital anomalies in England. *Occupational and Environmental Medicine*. 2009;66(2):81-9.
72. Sudlow C, Gallacher J, Allen N, Beral V, Burton P, Danesh J, et al. UK Biobank: An Open Access Resource for Identifying the Causes of a Wide Range of Complex Diseases of Middle and Old Age. *PLOS Medicine*. 2015;12(3):e1001779.
73. Pantelopoulos A, Bourbakis NG. A survey on wearable sensor-based systems for health monitoring and prognosis. *Trans Sys Man Cyber Part C*. 2010;40(1):1-12.
74. Doiron D, Burton P, Marcon Y, Gaye A, Wolffenbuttel BH, Perola M, et al. Data harmonization and federated analysis of population-based studies: the BioSHaRE project. *Emerging themes in epidemiology*. 2013;10(1):12.
75. Pew Environmental Health Commission. *America's Environmental Health Gap: Why the County Needs a Nationwide Health Tracking Network: Technical Report*. Baltimore, Johns Hopkins University School of Public Health. 2000. Available from https://www.jhsph.edu/research/centers-and-institutes/center-for-excellence-in-environmental-health-tracking/pew_technical_report.pdf.
76. Creech JL, Jr., Johnson MN. Angiosarcoma of liver in the manufacture of polyvinyl chloride. *J Occup Med*. 1974;16(3):150-1.
77. Corfiati M, Scarselli A, Binazzi A, Di Marzio D, Verardo M, Mirabelli D, et al. Epidemiological patterns of asbestos exposure and spatial clusters of incident cases of malignant mesothelioma from the Italian national registry. *BMC Cancer*. 2015;15:286.
78. Bunch KJ, Vincent TJ, Black RJ, Pearce MS, McNally RJQ, McKinney PA, et al. Updated investigations of cancer excesses in individuals born or resident in the vicinity of Sellafield and Dounreay. *Br J Cancer*. 2014;111(9):1814-23.
79. New York City Department of Health and Mental Hygiene. *The New York City Community Air Survey: Neighborhood Air Quality 2008-2015*. 2017. Available:

- <http://www1.nyc.gov/assets/doh/downloads/pdf/environmental/comm-air-survey-08-15.pdf>.
80. McKelvey W, Blank J, Kheirbek I, Torin B. Using Tracking Data to Promote Environmental Public Health Through Regulatory and Legislative Processes in New York City. *Journal of public health management and practice : JPHMP*. 2017;23 Suppl 5 Supplement, Environmental Public Health Tracking:S32-s8.
 81. Kheirbek I, Haney J, Douglas S, Ito K, Caputo S, Jr., Matte T. The public health benefits of reducing fine particulate matter through conversion to cleaner heating fuels in New York City. *Environmental science & technology*. 2014;48(23):13573-82.
 82. Newton JN, Briggs ADM, Murray CJL, Dicker D, Foreman KJ, Wang H, et al. Changes in health in England, with analysis by English regions and areas of deprivation, 1990–2013: a systematic analysis for the Global Burden of Disease Study 2013. *The Lancet*.386(10010):2257-74.
 83. Department of Health. Public Health Surveillance - towards a Public Health Surveillance Strategy for England. 2012. Available from https://www.gov.uk/government/uploads/system/uploads/attachment_data/file/213339/Towards-a-Public-Health-Surveillance-Strategy.pdf.
 84. Pew Environmental Health Commission. America's Environmental Health Gap: Why the County Needs a Nationwide Health Tracking Network: Technical Report. Baltimore, Johns Hopkins University School of Public Health. 2000. Available from https://www.jhsph.edu/research/centers-and-institutes/center-for-excellence-in-environmental-health-tracking/pew_technical_report.pdf.
 85. New York City Department of Health and Mental Hygiene. The New York City Community Air Survey: Neighborhood Air Quality 2008-2015. 2017. Available: <http://www1.nyc.gov/assets/doh/downloads/pdf/environmental/comm-air-survey-08-15.pdf>.
 86. McKelvey W, Blank J, Kheirbek I, Torin B. Using Tracking Data to Promote Environmental Public Health Through Regulatory and Legislative Processes in New York City. *Journal of public health management and practice : JPHMP*. 2017;23 Suppl 5 Supplement, Environmental Public Health Tracking:S32-s8.
 87. Kheirbek I, Haney J, Douglas S, Ito K, Caputo S, Jr., Matte T. The public health benefits of reducing fine particulate matter through conversion to cleaner heating fuels in New York City. *Environmental science & technology*. 2014;48(23):13573-82.
 88. Khan SA, Emadossady S, Ladep NG, Thomas HC, Elliott P, Taylor-Robinson SD, et al. Rising trends in cholangiocarcinoma: Is the ICD classification system misleading us? *Journal of Hepatology*. 2012;56(4):848-54.
 89. Perlman SE, McVeigh KH, Thorpe LE, Jacobson L, Greene CM, Gwynn RC. Innovations in Population Health Surveillance: Using Electronic Health Records for Chronic Disease Surveillance. *American journal of public health*. 2017;107(6):853-7.

90. Creech JL, Jr., Johnson MN. Angiosarcoma of liver in the manufacture of polyvinyl chloride. *J Occup Med.* 1974;16(3):150-1.
91. Corfiati M, Scarselli A, Binazzi A, Di Marzio D, Verardo M, Mirabelli D, et al. Epidemiological patterns of asbestos exposure and spatial clusters of incident cases of malignant mesothelioma from the Italian national registry. *BMC Cancer.* 2015;15:286.
92. Bunch KJ, Vincent TJ, Black RJ, Pearce MS, McNally RJQ, McKinney PA, et al. Updated investigations of cancer excesses in individuals born or resident in the vicinity of Sellafield and Dounreay. *Br J Cancer.* 2014;111(9):1814-23.
93. Newton JN, Briggs ADM, Murray CJL, Dicker D, Foreman KJ, Wang H, et al. Changes in health in England, with analysis by English regions and areas of deprivation, 1990–2013: a systematic analysis for the Global Burden of Disease Study 2013. *The Lancet.*386(10010):2257-74.

ends

Chapter 09

Measurement and communication of health risks from pollution

Chapter lead

Kevin McConway¹

Chapter authors

Kevin McConway¹, Helene Joffe², E. Marian Scott³, David Spiegelhalter⁴, Heather Walton^{5*}

¹ Emeritus Professor of Applied Statistics, The Open University

² Professor of Psychology, University College London

³ Professor of Environmental Statistics, University of Glasgow

⁴ Winton Professor of the Public Understanding of Risk, University of Cambridge

⁵ Senior Lecturer in Environmental Health, King's College London

* *Dr Heather Walton's post was part-funded by the National Institute for Health Research Health Protection Research Unit (NIHR HPRU) in Health Impact of Environmental Hazards at King's College London in partnership with Public Health England (PHE). The views expressed are those of the author and not necessarily those of NHS England, the National Institute for Health Research, the Department of Health and Social Care or Public Health England.*

Summary

- With pollution, there is always a trade-off between the benefit to humans of the polluting activity and the risk to health.
- Measurement of health harms from pollution is often complicated, because of difficulties of measuring exposure, the (often long) timescales involved and the fact that a pollutant may have different acute and chronic effects, the impossibility of most kinds of experimenting on humans and hence the difficulty of assigning cause, human variability, many sources of uncertainty and the range of scientific disciplines involved.
- There is an extensive research tradition on the communication of risk, going back many decades, mostly based in psychology and related fields. Psychological theories of behaviour change are important in developing effective communication of risk
- Good communication requires a clear understanding of the audience and of what one wishes to communicate. Research has established the importance of feeling and emotion in risk communication.
- The use of public engagement in developing communication on pollution risks has been patchy, though the importance of public engagement in most areas of communication in medicine and health is well established. However, there are good exemplars in pollution communication.
- Trust in the research and its communicators are vital. A communicator must provide the evidence in a form that allows the audience to assess trustworthiness. Trust requires a relationship between the communicating parties, which is another important reason for considering the role of emotive and experiential aspects.

Introduction

Pollution poses a range of health risks. That said, the quality of current knowledge about the health risks from different pollutants is very variable: the risks are not always well *measured*. There are many reasons for this. The presence of pollutants changes over time – new threats are less well studied, as do the extent of public concern and the quantity of research funding – again causing inconsistent focus on pollutants. Further, some health effects are fairly direct and relatively easy to measure, while others are more complex, relating to long-term patterns of exposure, involving many specific pollutants or having a significant time lag from the exposure. The emphasis in this chapter is on measuring health risks to humans. There are good reasons to monitor pollutant levels and to reduce pollution, which are not primarily driven by human health concerns. These measurements however, are not the focus of this chapter.

It makes little sense to concentrate narrowly on the communication of ‘facts’ about health risks from pollution. In communicating to the public, the underlying aim is often to change individual behaviour to mitigate risk, or to increase awareness and engagement. The long tradition of research and understanding of communication about risks indicates that the communication must go well beyond simply telling the public the size of the risk in a comprehensible form.

Issues of measurement and communication of human health effects are to some extent common to different pollutants and to some extent not (for examples see Boxes 9.1, 9.2 and 9.3). Several of the examples in the chapter relate to air pollution; this is not because air pollution is necessarily more important, in relation to health, than other pollutants, but only because it is better researched than many other types of pollution and because it demonstrates the issues well.

Putting together an accepted causal narrative about the health effects of a pollutant, and communicating it effectively, is a complicated business. Box 9.4 relates the research and communication needs for pollution health risks to a different kind of example – health harms from smoking. Many health risks from tobacco are now well understood and effective actions have been taken to mitigate them – but to get to this position took many decades. Regarding pollution, health risks are more complicated, less clear and usually harder to research than with tobacco. Yet the complication is not a reason to avoid action.

Box 9.1 The nature of our understanding of pollution in the environment: Radioactive particles

Radioactive particles have been discovered in the environment near the decommissioned nuclear facility at Dounreay. They are small fragments (sand size) of spent fuel that were released more than 20 years ago into the sea, which have been distributed by tides and storms, resulting in their deposition on beaches.^{1,2,3} The particles could prove a hazard if encountered by a beachgoer, so the regulator and site operators have been required to instigate routine monitoring. The exposure pathways include ingestion, inhalation and skin contact. The resulting dose depends on several factors, including the radionuclide involved, the activity, whether the particle is ingested (then how soluble it is), whether it is inhaled and how long an individual stays in contact with it (skin dose).

The detection of the particles is challenging, but a system using detectors attached to a beach buggy has been built. Each month, it is driven over the beach and when a signal is triggered (which depends on the spatially varying background radioactivity), the vehicle stops and the particle is retrieved and taken back to the laboratory where concentrations of radionuclides of interest are measured. To cover the entire beach takes the buggy many days and the chance of detecting a particle, if present, depends on its activity and depth. This is a difficult sampling problem since the pollutant is a very small particle, widely distributed and not uniform, whilst its detectability also depends on a dynamic population of particles on the beach (and tide).

Communicating that risk

For an individual beachgoer, exposure to the hazard depends on when they visit, and their activities. There are potentially only a small number of particles on the beach at any time, so the probability of encountering one is also very small. (In over 10 years of monitoring the number of particles retrieved is a few hundred). The Dounreay Particles Advisory Group concluded that

“only those particles [whose] activity is above a certain level pose a realistic potential to cause harm to members of the public, and the probability of the most frequent beach-users [...] coming into contact with a relevant particle is one in 80 million.”

Depending on the individual dose, health effects could include skin ulceration.⁴ In this case, the contaminant is not widely distributed in the environment and relatively few particles have been found, with a widely varying distribution of activity. There have been several interventions (including removal of seabed particles), but still particles are being found on public beaches and the risk of harm remains.⁵

E. Marian Scott, Professor of Environmental Statistics, University of Glasgow

Box 9.2 The nature of our understanding of pollution in the environment: Soil contamination

There are many studies that have shown that exposure to high concentrations of certain metals in soil can have potentially harmful effects such as cancer or developmental effects in young children.^{6,7,8,9} There is a location-dependent natural metal concentration background, but as a result of anthropogenic activities, heterogeneous elevated concentrations occur.

The measurement of such metals requires soil samples to be collected (spot samples) over a region of interest. The soil sample (which may be a few tens of grams) is subjected to a variety of physical and chemical processes in the laboratory before a concentration is reported. How sure are we of this value and how it should be interpreted? The measured value will have been subject to quality control within the laboratory, but will be uncertain to within typically a small value (the measurement error). In addition, as a spot sample, there will also be the uncertainty about the representativeness of the sample for the region.

How might the metal present in the soil have a health effect? First we need an exposure pathway – in the case of soil, this might be inhalation - small particles could become lodged in a lung, or by ingestion (eating directly or through the food chain – such as in plant's leaves or tubers). Thus an individual's exposure to the metal depends on their habits.¹⁰

The biological effect on the individual of the metal then depends on the concentration (dose) to which that individual is exposed and in a population, individuals will experience different doses and will manifest different degrees of health effect. There may be more than one metal of concern, therefore a combined exposure and health effect. Some of the evidence may be based on observational epidemiological studies from occupational exposure, with others in wider populations.¹¹

Communicating that risk

It may be that advice is offered suggesting that the vegetables are safe to consume since their concentrations are below a certain concentration; it may be that certain critical groups such as pregnant women or young children^{12, 13} are advised not to consume more than a certain quantity of the contaminated vegetables.

E. Marian Scott, Professor of Environmental Statistics, University of Glasgow

Box 9.3 The nature of our understanding of pollution in the environment: Trihalomethanes (THMs) in drinking water

Drinking water needs to be of high quality. We are all aware of serious health issues in countries where drinking water is not as well regulated and managed as in the UK.¹⁴ Drinking water flows in a chain from the reservoir or other source to treatment works to holding and then eventually is pumped to our homes. Our drinking supplies are tested for bacteria, lead, iron (which may come from cast iron distribution pipes) and other metals, nitrite, pesticides (both potentially from agricultural practices in the catchment providing the water source), pH, trihalomethanes (THMs) and other parameters.¹⁵ Water at the treatment works is disinfected using chlorine to deal with microbial contaminants and THMs are formed as a result of the reaction of the chlorine with (naturally occurring) organic material.

At elevated levels, THMs have been associated with health effects such as cancer and adverse reproductive outcomes.^{16,17} Some studies showing these effects have been carried out in animals, while others have used observational epidemiology **Error! Bookmark not defined.** There are concerns about long-term exposure to THMs¹⁸, however, the widely held view is that the “health risks from THMs are much less than the risks from consuming microbiologically unsafe water”.¹⁹ A clear line has been taken on trading off competing health risks. The EU and other bodies have defined maximum allowable concentrations in drinking water (100 µg (microgrammes) per litre) to help protect the population (and indeed especially vulnerable sub-populations). In defining such levels, the lifetime of the individual (assumed 70 years) and typical drinking volumes must be considered.

Regular testing is undertaken by the water companies and the drinking water regulator. There have been considerable improvements in the numbers of failures of the standard for THMs (100µg/l) becoming rare (average of just four failures a year since 2010) and in 2014, there were no failures of the THM standard in England.²⁰

Communicating that risk

In this example, the hazard being presented by the THMs is being balanced against the risk of drinking contaminated water. The evidence for health effects of long term exposure (in some cases based on animal studies) was considered not consistent²¹, and in some cases, results between different studies are inconsistent.

E. Marian Scott, Professor of Environmental Statistics, University of Glasgow

Box 9.4 Putting together evidence on health effects

In investigating possible health gains from an intervention at an individual level, the gold standard study is the randomised clinical trial. Yet randomised trials are more difficult with interventions at a population level and carrying out a randomised trial to investigate potential adverse health effects is usually ruled out on ethical grounds. So how do we establish and measure the harmful effects of exposure to a substance such as a pollutant?

It might help to consider a different kind of health risk. Nowadays everyone knows that smoking cigarettes vastly increases the risk of several diseases. But how do we know that? The underlying research did not come from a single study, or even a single type of research, but unavoidably involved epidemiological research in human populations (such as Doll and Hill's study of British doctors^{22,23}), studies which found that exposing experimental animals to substances in tobacco smoke led to the development of cancers and several other study types. Animal studies established the carcinogenic potential of cigarette smoke, but could not - on their own - show this in human populations. The epidemiological studies showed a (strong) correlation between smoking and lung cancer in humans, but on their own could not establish that the effect was causal. The risk is stochastic – that is, not everyone who is exposed will suffer harmful health effects, so that an element of chance is operating. To establish a clear causal narrative linking smoking to lung cancer and other diseases required evidence from all these sources to be put together, a process that took many years. And after the links were clearly established, there were further issues of communicating them to the public and making appropriate policy interventions – an ongoing process that has taken half a century so far.

Establishing and measuring health risks from pollution has to involve a similar process of putting together different kinds of evidence from different types of study. Answers cannot come from one or two critical experiments. With environmental pollutants, exposures are typically much harder to measure than with (active) smoking and the magnitudes of the health risks at an individual level are usually considerably smaller. Yet, because very large numbers of people may be exposed, the overall public health impact may be very large. Thus it is crucial to combine results from different research traditions to measure health risks from pollution. Compared to investigating the health risks from a pollutant, understanding the risks of cigarette smoking was in most respects an *easy* target. It still took a great deal of time and effort to provide the necessary evidence and make effective policy interventions. Difficulties in measuring, communicating and acting on the health risks of pollution must not be an excuse for inaction.

Kevin McConway. Emeritus Professor of Applied Statistics, Open University

The contexts

It is important to take account of the contexts within which health risks from pollution are discussed and considered. Knowledge of these contexts, particularly about the way the risks are construed by the general public, is far from complete.

Pollutants generally arise because of human activities that are desired. People value the products of industrial processes that pollute and may not be happy when measures to reduce pollution increase the cost of those products, or reduce their availability. People, on the whole, like driving their cars and many feel that they have rights to do so; these feelings conflict with measures to improve air quality by restricting car use. More broadly, we wish (indeed, need) to travel, for many reasons, and the gains from the travel need to be traded off against the various kinds of pollution that arise from transport activities. Using precautionary principles may be useful in a few contexts, such as where an intervention has low costs, in all senses. Yet all mechanised transport cannot be ceased on a precautionary principle. This emphasises that trade-offs are inevitable.

Trade-offs arise in most economic contexts, but changing where the balance lies in a trade-off between a desired activity and its polluting consequences can be particularly difficult. This is because many important pollutants cannot be seen, tasted or felt. Their health impacts may be subtle and may take a long time to become apparent after exposure. Thus the way that the trade-off works is obscure. Moreover, public attitudes to these matters have not been extensively researched, though they are likely to be variable between individuals and between those who aim to influence opinion. There may well be a range of public opinions, which may include, at one extreme, the view that pollution is an unavoidable by-product of economic prosperity, and, at the other, an exaggerated precautionary principle that everything that pollutes and is potentially harmful in any way must cease. Both of these extremes have certainly appeared in political and academic discourse about pollution.^{24,25,26} Arguably they are to a considerable extent straw men, but they need to be challenged where they arise. We have to work hard if we wish to arrive at an evidence-based narrative that will be consistent and credible across all the relevant audiences.

All of this implies that evidence for changing behaviours needs to be solid (implying good measurement) and persuasive (implying good communication).

Measurement

The difficulties with pollution

Arguably, measurement of health risks to the public from pollution has not advanced as far as the measurement of many other kinds of health risks. This has to do with the nature of the work required, with several sources of difficulty:

- Many pollutants are present in the environment, they occur together, therefore it is difficult to disentangle which pollutant is linked to which health effect. A related issue is that some health effects are caused by mixtures of substances rather than by single compounds; this adds complexity. In the environment, the composition of mixtures can vary substantially, making exposure levels difficult to measure and to correlate with health.
- The health effects of a pollutant may vary with the timescale of exposure. The health effects from a short-term acute exposure can be very different from those of a long-term exposure. Peak exposure may be the key factor for some effects on health, while the ambient level may be more important for others. (More below.)
- Many health effects of pollution only become apparent after a long time. This may be because the condition takes a long time to develop, or because it is caused by exposure over a long period of time. Long-term effects can be measured, but, the longer the term, the harder accurate measurement is and the greater the cost of measurement.
- Exposure of individual people to pollutants, in the real world, is often very difficult to measure accurately. This can even be the case when the levels of pollutants in the environment are accurately known. As an example, individual exposure to lead depends on childhood experience, occupational exposure, whether the individual lives or lived in a house that still has lead pipes or lead paint, on diet, and on the geographical location where one lives. Mathematical modelling may help, though it is difficult without detailed lifestyle information. Modelling adds to complexity but does not remove all the uncertainty.
- Much research in the real world uses observational epidemiology. It is difficult, often impossible, to be clear about causality in observational studies because of the effects of confounding. An apparent health effect of a water pollutant might be caused by exposure through a different diet. Confounders can be allowed for statistically, but the possibility of residual confounding always remains.

- People vary. In particular they vary, often considerably, in the extent to which a particular pollutant may affect their health. For instance, the effects of poor air quality are different between people with asthma and others, between different people with asthma and in the same person on different occasions. In some situations, it may be possible to model and describe how the health effects vary in terms of personal characteristics, but often there is insufficient data or understanding of the mechanisms to do this effectively. This variability is different from the uncertainty about the size of health effects, although this variability can in turn lead to further uncertainty about the nature and size of the health effects.

As exemplified in Boxes 9.1 and 9.2, developing an understanding of health risks from pollution involves multiple stages, each with uncertainty and complicated by variability. It may be necessary to use mathematical and statistical modelling, based on data from several sources, to estimate the health effects of a pollutant at local levels. Policy makers and others therefore need to be primed to expect different (and generally more complicated) forms of evidence and measurements of risk than might be used with other threats to health. For researchers and advocates in this field, this also draws attention to a need to communicate about the nature of the evidence as well as simply communicating the evidence.

For policy choices in particular, ideally one needs reasonably precise measurement of the effects of pollutants in a real-world context. It is too much, however, to expect that all health effects of pollution can be measured precisely. Policy makers need to understand that one can act with confidence that the action is appropriate, that is, if one can be sufficiently confident that the action is beneficial (taking costs appropriately into account), even if there remains considerable uncertainty about the actual size of an effect.

Measurement methods

It is possible and important to learn about physiological effects of pollutants from laboratory experiments on animals or tissue samples. This is generally the approach of toxicology to investigating health effects of pollution. However, most experimental work with humans on health of pollution effects is not possible: one cannot choose susceptible people at random to be exposed to highly polluted air or water. Therefore, studies in humans mostly have to be observational, using the methods of epidemiology. Put simply, one compares health outcomes in individuals exposed to differing levels of pollutants. These two approaches have been dominant in measuring health effects of pollution (Table 9.1).

Table 9.1 Comparison of toxicology and observational epidemiology in investigating health effects of pollution

	Toxicology and pollution	Epidemiology and pollution
Overview	<i>Focus on pollutants (chemicals), examining their actual or potential hazard on – in this case – humans: laboratory studies</i>	<i>Studies (and seeks to control) the impact that pollutants have on human health across populations: ‘real-world’ studies</i>
Methods	Studies the effects that pollutants have on tissue or animal models, in controlled conditions, with control groups. It investigates the dose-response, mode of action and species specificity – amongst other facets – of an agent.	Examines the distribution of health states in or across populations, and their association with the distribution of exposure to pollutants. Pollution epidemiology largely observes existing exposures.
Strengths	<ul style="list-style-type: none"> • focus on single agent in a controlled setting, therefore no confounding • exposure to the agent of interest is quantified directly; • examines the mode of action 	<ul style="list-style-type: none"> • unit of study is the unit of interest – the human • ‘real world’ studies, therefore directly reflect the exposure faced by people
Weaknesses	<ul style="list-style-type: none"> • Extrapolation required from the animal/ tissue model to humans • Effect does not account for impact of other ‘real world’ stressors which can modify the impact of pollutant • High doses of a substance used in a toxicological study might never be seen in human populations • Real world exposure route might differ (e.g. through lungs), and impact on biological effect 	<ul style="list-style-type: none"> • Confounding and co-occurrence of pollutants can be hard to control • Ubiquity of pollutants can mean little variation in exposure across populations • Even if a pollutant is measured in the environment, the dose received by people can be hard to measure • Study samples often not the whole population therefore some extrapolation needed

Challenges and next steps	Fully assess the toxicity and harm from complex mixtures and their interactions	Methods and data to assess low level, chronic exposure – overcoming co-occurrence of pollutants and homogeneity of exposure
	Concerns remain that the two disciplines work in parallel, not truly and fully together. They have different paradigms, which might be incompatible – but an integrated and systematic use of information and evidence would allow stronger inference about causality. Formal frameworks have been proposed to do this risk assessment. ²⁷	
Example	<p>A 2000 study exposed 12 dogs to concentrated particulate matter (PM) (30 times higher than in Boston at the time), 6 of which had induced coronary occlusions to mimic existing coronary artery disease. Dogs' response to the PM was assessed by ECG.</p> <p>Dogs with induced coronary artery disease and exposed to the PM had a shorter time to ST segment elevation and an increase in magnitude of it: a sign of myocardial ischaemia (restricted oxygen to heart muscle) when in humans.²⁸</p>	<p>A 1999 study compared daily counts of cardiovascular disease (CVD) hospital admissions (in over 65s) with the mean PM₁₀ reading from the monitoring stations in 8 US counties.</p> <p>Allowing for confounding variables, such as the daily temperature, the study found that the changes in PM₁₀ were associated with CVD admissions (a central estimate of a 2.8% increase across the interquartile range of PM₁₀ exposure).²⁹</p>

Toxicology and observational epidemiology, although the most common, are not the only methods. In some cases, health effects in humans can be studied using experiments using human volunteers. These have most of the strengths of toxicological experiments (Table 9.1) – controlled conditions, accurately quantified exposure, (generally) accurately quantified response and specificity. However, it is not possible to use large numbers of subjects and the need to avoid deliberate serious harm to subjects means that only minor and temporary effects can be studied and only in those who are healthy or mildly ill.

Specific areas of concern, where there is need for further research, include:

- The extent to which health harms from pollutants are related to ambient (average) exposures or to peak (acute) exposures.^{30,31,32}
 - This is an important knowledge gap, partly because appropriate policy responses can depend on the balance between these. For example, interventions have dramatically reduced the size and number of peaks in ground-level ozone, but background levels have risen.³³ Longer-term studies and longer-term, more accurate, exposure assessment would help to disentangle the two effects. Locations with high peaks tend to have high ambient exposures, however, adding difficulty. Furthermore, this would require specific long-term (expensive) epidemiological cohort studies. Most previous long-term studies in this area have been within cohorts designed for other purposes, with exposure measured retrospectively. Multi-disciplinary work, including research on biological mechanisms, would enhance the epidemiology results.
- It is possible to set up mathematical and statistical models to investigate the effects of potential policy interventions, but this can be hard. One recent example is the modelling of potential impacts the UK Government's July 2017 Air Quality Plan.³⁴ Often, though, this modelling will involve extrapolation beyond situations that have been observed and there may be limits to the extent to which that extrapolation can be based on firm science.

Recent advances and next steps

Despite difficulties, progress is being made. For example, in measuring individual exposure, there is now instrumentation to collect data at a more personal level and mathematical and statistical modelling based on individuals' movements – but this requires considerably more development. Rapid advances in informatics and in particular in availability of and use of big data, are providing new opportunities to learn about (and indeed communicate) the health effects of pollution.

Understanding and measuring the health effects of a pollution source will involve collaboration between different research traditions and professions (toxicology, epidemiology, atmospheric chemistry, environmental health, informatics and mathematical and statistical modelling etc.). Such collaboration does occur already. Some toxicological studies investigate whether an effect from an epidemiological study is causal. Epidemiology can look at whether effects suggested by toxicology operate in human populations. However, generally, funding for research into health risks from pollution in the UK has been split between different Government departments and research councils – leaving gaps unfilled. The Nurse review³⁵ highlighted a need for better support of multi-disciplinary and interdisciplinary research, and UK Research and Innovation (UKRI) is currently being set up in response. Focused multi-disciplinary and interdisciplinary research into health risks from pollution, including research into effective methods for synthesising different types of information and evidence from different research traditions to produce an overall meaningful narrative, and (importantly) extending into appropriate ways of communicating the risks, is an area where UKRI could make an important difference.

4.4 Measurement for a reason

Measurement in this area, as in others, should always be done for a reason. Of course, the overarching reason for any measurement in public health is to improve the health of the public, but that can operate at many levels. Much research on health effects of pollution is aimed primarily at understanding those effects scientifically and the associated communication would largely be aimed at other researchers rather than directly at policy-makers or the public. Yet wider consideration of communication needs must sometimes inform the planning and execution of research.

One vital and occasionally neglected aspect of the measurement of health risks from pollutants, is that the outcomes must be expressed in terms that can be communicated appropriately, to policy makers and to the wider public. There needs to be a comprehensible currency for measuring the harms to health. In relation to air pollution, COMEAP³⁶ proposed two different measures, for different types of communication Boxes 9.5 and 9.6. These, however, relate only to effects on mortality. There has been considerable research measuring morbidity, as well as death, for many pollutants but less has been done to investigate how to communicate this. Policy makers may also require comparative information on different health risks. Considerable effort in mathematical modelling may be required to produce these comparisons.³⁷ This leads into the subject of the next section, but there is a feedback loop. If the communication, for example, is to be about deaths or years of life lost – in order to compare (with obesity, mental illness, etc.) – measurement must provide those quantities.

Box 9.5 Communicating about mortality effects: COMEAP's consideration of mortality associated with long-term exposure to air pollution

For policy analysis, the benefits of reductions in levels of particulate pollution are best assessed using actuarial life-table methods to estimate years of life gained because of the reduced exposure of the population.¹³ However, mortality benefits of small reductions in pollution, expressed as years of life lost, might not be well suited to communicating the size of the effect of air pollution on public health. Estimates of the mortality burden associated with current levels of pollution are more useful in highlighting the public health importance of good air quality and in encouraging action to reduce pollution.³⁸

The mortality burden can be expressed in a number of different ways: attributable fraction; attributable deaths; years of life lost; or loss of life-expectancy from birth. All of these describe the overall effect across the population, rather than representing effects on individuals: long-term exposure to air pollution is a contributory factor to deaths from respiratory and cardiovascular disease and is unlikely to be the sole cause of individual deaths. Therefore, although 'percentage of mortality' or 'number of deaths' are widely used in communicating public health risks, 'attributable deaths' is not the number of individuals whose length of life has been shortened by air pollution. Air pollution contributes a small amount to the deaths of a large number of exposed individuals rather than being solely responsible for a certain proportion, or number, of deaths. Attributable deaths can therefore more accurately be described as 'an effect on mortality equivalent to 'X' deaths at typical ages' and this is the terminology that the Committee on the Medical Effects of Air Pollutants (COMEAP) has recommended.^{36,38}

Although there are some differences in the methods used to calculate mortality burdens attributed to different public health risk factors (e.g. air pollution, smoking, alcohol), the approaches adopted are similar. Nonetheless, the estimates are not directly comparable.³⁹ Long-term exposure to particulate air pollution affects deaths from the same sorts of diseases (respiratory and cardiovascular) as smoking. However, air pollution is a contributory factor to mortality rather than the sole or primary cause of death. This is different from smoking and alcohol, which can be the primary underlying cause of some deaths.

Acknowledgement:

This information draws on the thinking of the Committee on the Medical Effects of Air Pollutants (COMEAP): www.comeap.org.uk

Alison Gowers, Air Quality and Public Health Group, Public Health England

Box 9.6 Putting numbers on the impact of pollution

We've seen in Box 9.4 that communicating the possible harms of air pollution is complex. As a specific example, consider the much-quoted claims that 29,000 deaths each year are due to fine particulate air pollution.³⁶ This is obtained by a complicated statistical model, but in fact it's easy to get to a rough figure.

COMEAP assume a relative risk of 1.06 per 10 $\mu\text{g}/\text{m}^3$ increase in $\text{PM}_{2.5}$, meaning that the average risk of dying each year is increased by 6% for every extra 10 μg of $\text{PM}_{2.5}$ per cubic meter of air (more formally, this is known as a 'hazard ratio'). The average exposure to human-made $\text{PM}_{2.5}$ is around 9 $\mu\text{g}/\text{m}^3$ in the UK, so on average mortality risk is increased by around 5%, or equivalently around 5% of all deaths are associated with $\text{PM}_{2.5}$. There are 600,000 deaths a year in the UK, and 5% of 600,000 is 30,000 deaths, which is remarkably close to COMEAP's actual estimate of 28,861 attributable deaths.

But the crucial issue, repeatedly emphasised by COMEAP, is that we cannot identify these 29,000 as individuals— nobody has 'pollution' on their death certificate as a cause of death. As pointed out in Box 5, it might be better to describe this as an effect on mortality equivalent to '29,000 deaths' – Table 1 shows a variety of other ways of expressing the same impact.

Table 1 *Estimated annual impact in UK of human-made $\text{PM}_{2.5}$ pollution (2008 level)*

<i>Measure of effect</i>	<i>Estimate</i>	<i>Plausible interval</i>
'Attributable deaths'	28,811	5,000 to 60,000
Burden on total survival (life-years lost)	340,000	55,000 to 680,000
Average loss in life expectancy:		
For whole population aged 30+: (38,000,000)	3 days	½ to 6 days
For all deaths (600,000)	7 months	1 to 14 months
For deaths from cardiovascular causes (191,000)	2 years	4 months to 4 years
For 'attributable deaths' (29,000)	11.5 years	2 to 23 years

All these results are driven by this estimated relative risk of 1.06, a figure that was originally derived from studies of US cities⁴¹ and has been reinforced by pooled analysis of other studies⁴², but with tighter confidence intervals.

It is important to note the uncertainty associated with these estimates. The 6% increase (relative risk 1.06) comes with a standard statistical confidence interval, but COMEAP carried out an interesting elicitation of expert judgement to widen this interval to create a 'plausibility distribution', which resulted in an assessment that the range of 1% to 12% represented a 75% plausibility interval and should be used for sensitivity analysis: a 95% interval based on expert subjective assessment ran from 0% (i.e. no effect of particulates) to 15%. This judgement of uncertainty is reflected in

Table 1. This plausibility range is remarkably wide (although might be somewhat narrower now in the light of more recent studies), but there is sufficient evidence of a substantial impact to justify mitigating actions.

Additional uncertainty arises from many sources, including the structure of the statistical model and the degree of overlap of between the effects of different pollutants.

*David Spiegelhalter, Winton Professor of the Public Understanding of Risk,
University of Cambridge*

Communication

The communication landscape

We are not starting from scratch in communicating health risks from pollution to the public and to other audiences. The way publics apprehend risks has been an active area of research for more than half a century. Perception, as well as how targets think about the subject area before the risk communications, must be taken into account (and targeted) by those needing to communicate risks. Beyond academic work, areas of government have worked on managing and communicating risk⁴¹ and on specific aspects (Box 9.6). The Academy of Medical Science has produced a major report on how best to use scientific evidence in relation to the benefits and harms of medicines, including how to communicate them.⁴²: much of what it says applies equally to the harms and benefits of interventions on pollution. In addition, international agencies have developed different ways of classifying and communicating risks (7^{and} 43). Specifically regarding pollution, COMEAP discusses how to communicate the impacts of air quality (Box 9.8).

One thing that this work into risk communication has established clearly is that it is time-consuming and often difficult to make changes by way of communication. One cannot expect to change either policies or the behaviour of individual members of the public solely by communicating what has been measured regarding the health effects of pollution, however well-understood that communication may be. There are no magic communication bullets to bring about change.

Box 9.1 Communicating the risk of severe flooding

One in six properties in the UK are at risk of flooding but many residents are unaware whether their home is at risk or, if it is, what they can do in the event of a flood.

Recent research has shown that not only does flooding present a risk to life and cause damage to property but it can also have long-term health and social effects. Such effects include anxiety, depression and post-traumatic stress. Also, disruption to schooling and friendship groups due to living in temporary accommodation (often for a year or more) can affect the development of children. Reducing or preventing flooding can avoid or limit the worst of these effects by enabling a return to normal life quickly.

Working with Sciencewise, the Environment Agency, undertook a public dialogue to find out what people knew about their own flood risk and how to improve communication. The findings showed that people want clear and simple information about whether their home is at risk of flooding and what they can do to prepare for a flood. They did not find information on the probability of flooding helpful as it was difficult to know what to do and how to interpret this. Also, broad scale maps showing flood risk across the country were seen as too high-level and not giving information relevant to individuals.

The way people, especially Millennials, want to receive information is changing. An estimated 99% of this age group use social media with over 40% checking it over 10 times a day. This group of people also tend to live in areas of higher flood risk but at the same time have lower awareness.

These insights into the perspectives of those at risk of flooding have proved very valuable and really challenged thinking that more detailed information was better. The findings of the public dialogue have influenced work by the Environment Agency to redesign its flood warning services with easier ways to find out about flood risk, especially via social media. There are also improved links to resources for how to increase flood resilience and actions to take if a flood is imminent.

Cr Doug Wilson, Director of Evidence at the Environment Agency

Box 9.7 Examples of approaches to expressing confidence and uncertainty about risks

The UN’s Intergovernmental Panel on Climate Change (IPCC) has refined its approach to presenting information on uncertainty through its Assessment Reports. The most recent, the 5th Assessment Report⁴⁴ (AR5), distinguishes between the confidence of a finding and quantified measures of uncertainty in it.⁴⁵ Generally, authors were discouraged from providing quantified probability measures, except in cases where the confidence in the validity of a finding was high – with agreement between experts and the robustness of evidence. Levels of confidence are expressed in qualitative terms only, using the scale “very low,” “low,” “medium,” “high,” and “very high.” (This was in contrast to the 4th Assessment Report where the same words were explicitly linked to a quantitative scale⁴⁶).

Where the probability of an outcome had been quantified, at least approximately, authors used an agreed way of translating ranges of probabilities into words:

Term	Probability
Virtually certain	99-100%
Very likely	90-100%
Likely	66-100%
About as likely as not	33-66%
Unlikely	0-33%
Very unlikely	0-10%
Exceptionally unlikely	0-1%

The IPCC approach has been widely praised; one potential issue is that, however consistent authors may be, readers may be inconsistent in their understanding of verbal descriptions of probability.⁴⁷

continues next page

The World Health Organization's International Agency for Research on Cancer (IARC) categorises possibly carcinogenic agents, most of which are pollutants, into five groups in terms of *hazard*, that is, the strength of evidence that they have a cancer-causing effect in humans.⁴⁸ They explicitly do not specify the level of *risk*, partly because, in many cases, the main evidence of carcinogenicity comes from toxicological and similar studies, which do not generally provide measures of individual or population risk in humans. Therefore two different agents, both classified by IARC as *possibly carcinogenic to humans*, such as non-ionizing electromagnetic radiation from mobile telephones and petrol exhaust fumes, may present very different cancer risks and levels of public health concern.

This has caused considerable confusion in media reporting of IARC classifications when IARC review an everyday exposure^{49,50}, (e.g. mobile phones, eating processed meat), despite increasing efforts from IARC to make their system clear. This can be seen as a failure of communication in which, if the information that people want is not provided, they may make false assumptions about the information that actually is provided.

Kevin McConway. Emeritus Professor of Applied Statistics, The Open University

Box 9.8 Taking the audience's views into account when communicating about pollution – using COMEAP's development of the Daily Air Quality Index as an example

The Committee on the Medical Effects of Air Pollutants (COMEAP) published updated recommendations for the UK Daily Air Quality Index (DAQI) in 2011 at Defra's request.⁵¹ The DAQI is used to provide information to the public about real-time and forecast levels of outdoor air pollution. It is accompanied by health advice intended to allow individuals who are sensitive to the effects of air pollution to modify their behaviour to reduce the likelihood or severity of symptoms.

As well as considering relevant scientific and technical issues, COMEAP was keen to ensure that its recommendations would meet the requirements of users of the index. In order to inform COMEAP's review, dedicated public insight research was undertaken.^{52,53} This included:

- small-group workshops of older people with respiratory/cardiovascular illnesses or children aged 9–11 years old (both with and without respiratory illnesses)
- focus groups with a geographical spread and timed to ensure that a cross-section of society (gender, age and socioeconomic status) could attend
- an online questionnaire to gather a broad spectrum of views

Public preferences for the DAQI and accompanying health advice were for:

- information which is clear, concise and easy to understand
- focused, jargon-free, activity (health) advice
- separate health advice for susceptible and non-susceptible groups
- clear identification of groups at greater risk than the general population
- avoidance of information that might be alarming or fear-inducing
- use of visual cues and colours

In addition, most participants wanted to know the level of air pollution in general, but not information about the levels of individual pollutants.

Although there was not a clear preference for the number of 'bands' or 'points on a scale' within the DAQI, a need for a scale that allowed greater gradation than provided by four pollution bands alone was identified. Participants disliked possible descriptors for pollution bands based on health risk (e.g. Low Health Risk to Very High Health Risk) but found descriptors based on either air pollution or air quality to be acceptable.

continues next page

COMEAP found the public insight research at the outset of the review very helpful in steering its discussions on some aspects of the DAQI. Its initial proposals, which took account of the views expressed, were then tested within additional focus groups. Feedback from these was used to further refine COMEAP's final recommendations for a revised DAQI and accompanying health advice.

Acknowledgement:

This information draws on the work and thinking of the Committee on the Medical Effects of Air Pollutants (COMEAP): www.comeap.org.uk

Communication for a purpose

We cannot communicate effectively without a reasonably clear understanding of which audience we are communicating to and what the aims are. This determines the choice of what is communicated, and how it is communicated. For instance, communicating to policy makers is, in several respects, different from communicating to the public (Box 9.9).

In communicating flood risk to the public (Box 9.6), for example, one may need to get people to take action to mitigate the effects of an imminent flood, or one may need to communicate levels of risk to people deciding where to live, or where to build houses. These different purposes require rather different approaches. Some pollution issues, such as communicating about peaks of air pollution to particularly susceptible individuals who ought to take action quickly, are similar to the situation of an imminent flood, but most pollution issues are less immediate and (in public communication) *the need is to extend awareness or promote behaviour change*.

Box 9.9 Communicating across disciplines including policy makers

Communication needs to be focused on the intended audience, so communication with experts in other disciplines and with those developing policy will necessarily be different from that designed for the public. The metrics in which results are expressed may also differ from those easily understood by the public. Life-years* (or quality-adjusted life years) are more appropriate for analysing policies than numbers of deaths, as it is when people die rather than whether they die that matters. They can be used to communicate relative importance of different policy areas, such as the fact that removing widespread exposure to air pollution would lead to more life-years gained than preventing road accidents (although the causal basis of the latter is clearer).

Working across disciplines can lead to a powerful improvement in the ongoing development of the quality of the evidence supporting measures to improve health. For example, understanding the correlation between pollutants is key to interpreting epidemiology studies. With older techniques, air pollution effects stopped being detected⁵⁴ until statisticians applied time-series analysis.⁵⁵

It is important for communication to be interactive. Other disciplines may identify new questions that need to be asked. Government committees provide one forum for multi-disciplinary discussions.^{56,57} Disciplines have different strengths – epidemiology studies reflect reality more closely, in all its complexity, whereas toxicology studies are more specific but less representative. Reflecting these perspectives and systematically reviewing the expanding literature, needs to be maintained and resourced. Focusing on one area or only updating previous documents⁵⁸ is understandable for short-term prioritisation but would lead to loss of knowledge long-term.

In the policy context, joint working across Departments allows discussion of the health risks and the implications as a policy develops. This has been the practice in outdoor air quality policy⁵⁹ as acknowledged by the National Audit Office⁶⁰, but may be less developed in other areas e.g. indoor air quality policy.

Investigating questions that are crucial for policy can be scientifically demanding. Economists designing questions for willingness to pay studies⁶¹ wish to transmit information that may not be easily derived from population-wide studies. Regulation by specific pollutant requires disentangling of effects in a way that may be difficult in epidemiological studies.⁶² Those developing environment and health policies need to communicate policy challenges to specialists who need access to research funds that can be targeted at these questions.^{63,64}

Heather Walton, Senior Lecturer in Environmental Health, King's College London

* One year lived by one person, adding up across the population and over time.

Risk perception theory

Several areas of psychological research are relevant to the communication of pollution's health risks. Firstly the area of *risk perception* has provided insight into the three key factors that lead people to be concerned about risks⁶⁵ their demographics (groups with less political or socio-economic power feel more concerned), the characteristics of the risks themselves (e.g. how controllable and dreaded they are perceived to be) and a range of cognitive mechanisms (e.g. optimistic bias, overconfidence and the availability heuristic), which are lenses with which people absorb the risks communicated to them. More recently there has been a shift from focus on these more cognitive aspects of risk apprehension to the more affective, emotive aspects. This may weaken direct links between measurement and communication. If the aim is to engage the audience and (potentially) change what they do, it is not enough simply to get across the size of the risk. Box 9.11 explains the relevance of disgust to air pollution and health-related behaviours and Box 9.12 highlights a campaign from a different public health area that was particularly successful in engaging a wide public using more emotive cues.

Both the more cognitive and the more affective aspects have been reviewed, regarding climate change, in a model - the 'Dragons of Inaction'⁶⁶. Stemming from the risk perception field, a burgeoning *risk communication* field has produced a set of key principles for effective risk communication.⁶⁷ This includes use of images and human stories to convey risk, rather than numbers.

Box 9.10 Why risk information should not form the central aspect of a risk communication: Dual Processing

Communications to change health-related awareness and behaviours traditionally rest on the assumption that if experts can provide the public with information in an absorbable format, the information will then be known and heeded. However, this model suffers a number of problems addressed by the Psychology of Risk over the past half century. Most recently, within Psychology, there has been vociferous rejection of the importance of health risk information's potential to change awareness and, especially, behaviour. This is based on dual-process models that advocate that human behaviour is shaped by two systems: one more non-conscious, automatic and affective and another more deliberative and rational. This idea, popularised in Kahneman's⁶⁸ 'Thinking fast and slow', sees the first characterised by habit, impulse and emotion and the second as more consciously cognitive. Recent work in the risk sphere talks not just of the existence of the separate automatic/emotive and deliberative dimensions but of a sequence: 'feeling before thinking'.⁶⁹ The thesis that the first type is more primary when humans process risks is increasingly supported by neuroscience.⁷⁰

Numerical risk communications, therefore, are likely to be processed by the secondary, deliberative system, which is the less influential of the two systems. The empirical evidence for this is strong: two major reviews of health-related risk interventions found that information, even when given in a highly personalised form, had no perceptible effect on the targeted behaviour.^{71,72} Marteau et al.⁷³ advocate that environmental cues can therefore be used to change health-related behaviours as such change occurs at a non-conscious level - not amenable to information. However, one might argue, especially with promising communication effects seen in interventions with visual elements,⁷⁴ that another way of influencing the non-conscious is persuasion via visuals, with their tendency to be more emotionally evocative than textual and verbal messages.⁷⁵

The take home message is that risk information should not be a central aspect of risk communication to the public and that messages that speak to non-conscious affective systems are more likely to be effective.

Helene Joffe, Professor of Psychology, University College London

Box 9.11 How do people living in cities experience pollution? A Liveable Cities perspective from London and Birmingham dwellers

Using a novel, free association technique⁷⁶ that taps more latent factors than survey techniques do, we set out to examine *aspirations for future cities* in matched samples of people who dwell in the UK's two largest cities: London and Birmingham.⁷⁷ When we tapped the naturalistic, stored and arguably less conscious (and more primary, see Box 9.10 **Error! Reference source not found.**) conceptualisations, the wish for clean air featured prominently regarding desired aspects of future cities. When the city dwellers elaborated on their free associations in interviews that followed the task, transport, both public and private, was seen to be a source of pollution and dirt which evoked strong feelings of disgust. Disgust was associated with air pollution's sensory assault rather than with concern for its environmental impact or worry about its fatal consequences.

This intense dislike of pollution and exaltation of clean air could be garnered in efforts to reduce harmful emissions. Research demonstrates that disgust can be used highly effectively in risk communications to change risky health behaviours. In relation to smoking, in particular, exposure to disgusting messages, for example on cigarette packets, seems to reduce smoking behaviour. The use of graphic cigarette packaging warning labels in Canadian smokers, lead to 20% of the sample reporting smoking less as a result of the labels and 63% reporting at least one cessation benefit.⁷⁸ Similar results regarding hand hygiene in Australian experimental and field-based tests,⁷⁹ demonstrate that even brief disgust-based communications are effective. It is not only the emotional tone of disgust that is at work in graphic cigarette packaging warning labels but a visual, rather than textual or verbal, approach to communication (see Box 9.12). Emotive images play an effective role in communicating risk to the public.

Helene Joffe, Professor of Psychology, University College London

Behaviour change theory

Theories of *behaviour change* are also relevant to the communication of pollution's health risks. In the ascendant within this domain is the COM-B model⁸⁴, which posits that in order for behaviours to be taken on or changed, people need to have the capability, opportunity and motivation. Here, aspects like people's sense of self-efficacy affect their capability. Interestingly the risk communication and behaviour change literatures operate independently yet both would be enriched by the insights of the other.

While there has been widespread recognition of the limited role that information plays in changing health-related behaviours⁸⁵, it remains important to know what the numbers say. *Awareness* of the objective risk is a necessary though far from sufficient condition for behaviour change. Knowledge of the scale of a problem is central for policy makers, who must allocate resources on this basis. That said, a range of interests make it difficult for even the most severe risks to become prominent policy concerns. A concept of the different information needs of policy-makers and more general audiences is behind COMEAP's recommendation of different measures of health impact for different audiences . Research-based insights into effective ways of conveying information on health risks do exist and should be used where appropriate.

Communicating complexity

The scientific position on health risks from most pollution sources is complex and involves serious uncertainty. Therefore the question arises as to how far to reduce this complexity in communicating the risks. There has been considerable research and discussion into the most appropriate numerical measures to use in communicating health risks from air pollution. Gigerenzer's approach⁸⁶ does use numbers, but in ways that have been demonstrated to be more comprehensible. COMEAP proposed using different numerical measures for different purposes, and this has arguably had important impacts on how the risks are communicated. Communications from bodies such as COMEAP do not usually go directly to the public. This can introduce error. COMEAP's recommended wording for numbers of attributable deaths from air pollution, "an effect equivalent to a specific number of deaths at typical ages", seems not to be popular, unfortunately. Re-use and reporting of their conclusions largely omits their caveats.

While there is substantial uncertainty concerning the true magnitude of health impacts of air pollution, the high chance that there are substantial effects means that there is sufficient justification for mitigating actions. This can be communicated informally or in more formal sensitivity analysis in a cost-benefit model.

Next steps

The importance of engaging the public (and service users) in research and service development on health matters is clear in relation to risk communication.⁴² Despite some excellent exemplars (see Boxes 9.11, 9.12), in developing a shared understanding of the communication of quantitative information and use of emotion, such engagement is not as common as it ought to be. In the longer term, improvements in education on the environment, pollution and its health consequences, particularly at school level, can be an important step in increasing public awareness and engagement, though it does not remove the need to consider emotion and motivation in promoting behaviour change.

Finally, a key aspect of effective communication of information based on scientific research, of whatever kind, is the trust placed in the research and in its communicators. It must be remembered that it is the audience that decides whether a communicator or information source is trustworthy, not the communicator. Trust in science and scientists and in Government, is not always high.⁴² Openness and transparency are ways to help audiences to judge trustworthiness. The key aim should be for a communicator to provide evidence in a form such that its trustworthiness can be assessed^{87,88} – in that it makes sense to the audience, and they can see the evidence and act on it where necessary. Trust requires a relationship between the parties involved – another reason why more emotive, experiential aspects need to enter the communication.

Box 9.12 A successful risk intervention in public health: The Swiss Stop AIDS campaign

The Swiss Stop AIDS campaign began in 1987 and is ongoing, having broadened out to the host of sexually transmitted infections. The campaign has provided amusing, surprising, seductive visuals, as well as communications regarding the need for social solidarity, loving life and valuing of quality of life. This highly positively toned campaign has been accompanied by a vast and sustained increase in condom sales and condom use, with major health effects including a reduction in AIDS and sexually transmitted infections rates as a whole. Condom use in the Swiss public increased from 8% when the campaign first started in 1987 to 60% in 1992.^{89,90}

Persuasion was brought about by emotions such as humour, surprise and stressing the joy of life, as well as by calling for identification with people with AIDS rather than psychological (or spatial) distancing from them. Such distancing plays a major role in people's dis-identification from (and therefore dismissing of) a host of risk

communications.^{91,92} This central insight has now been adopted in a new generation of studies testing how to induce people to identify more with risk communications. One might argue that The Swiss Stop AIDS campaign's emotive visuals appealed primarily to the more emotive system of processing messages, rather than to the deliberative, rational system. It also, unusually, inserted its messages into commercial advertisements, for example, by inserting its symbol, a pink condom, into the Volkswagen symbol and so mixed public health broadcasting with private sector advertising.

This highly individual, closely evaluated campaign, with its strong emphasis on visual, emotive content demonstrates the potential for positively-valenced emotive communications (i.e. those communication that use a positive emotive tone, rather than fear or disgust, for example) to facilitate absorption of risk messages.

Helene Joffe, Professor of Psychology, University College London

Box 9.13 CleanSpace™ Tag: air quality monitoring for all

Conventional static air quality measurement stations are expensive and have high maintenance costs and are therefore often sparsely located. The Royal College of Physicians and The Royal College of Paediatrics and Child Health in the report published in February 2016 recommended that new technologies should be developed to improve air pollution monitoring to track population-level exposure to pollution.

In 2015 Drayson Technologies launched the CleanSpace™ Tag, a personal air pollution smart sensor and is a great example of how new technologies can be used to improve air pollution monitoring. The CleanSpace Tag linked to a smartphone app gathers hyper-local air pollution information allowing users to see the air they are breathing both indoors and outdoors and take action, such as avoiding busy roads or increasing the ventilation at home. This is particularly important for people most vulnerable from air pollution, highlighted by the fact that nearly a fifth of CleanSpace's top users have a respiratory condition.

“CleanSpace monitoring has become essential in planning my schedule and locations. I can look at the pollution readings and avoid polluted areas, preventing the onset of any respiratory symptoms and potentially avoiding a COPD attack. Knowledge is power!”

(Derek, a COPD sufferer and member of the British Lung Foundation, August 2017)

The CleanSpace community has generated over 100 million hyper-local data readings to date. However, it is vital that the data gathered by affordable air pollution sensors is credible and tested through independent scientific validation. The CleanSpace Tags use machine learning to dynamically calibrate the sensors keeping their readings accurate over time and they have been scientifically tested by the National Physical Laboratory and King's College London and shown to have a resolution of +/- 0.3ppm.

CleanSpace is bringing affordable and scalable personal monitoring not only to the public, but also to scientific communities, as a digital tool to compare the more complex traditional methods for measuring personal exposure to air pollution and the links to health conditions such as asthma or COPD.

James Clifton, Diana Stefan (Drayson Technologies)

Authors' suggestions for policy makers

- The involvement of several research disciplines and traditions in measuring the health effects of pollution is valuable and inevitable given the complexity of the field. However, there is a clear need for more funding and coordination of interdisciplinary work on such measurement, potentially also linking measurement to communication. This should also include research into effective methods for synthesising information and evidence from different research traditions. Responsibility thus far has been divided between several research councils (at least EPSRC, MRC, ESRC, NERC) as well as Government departments (Department for Environment, food and Rural Affairs, Department of Health and Social Care, and others). The start-up of UKRI provides an opportunity for better coordination and particularly for removing some of the barriers that have stood in the way of interdisciplinary and multi-disciplinary research.
- Public engagement has not been as prominent or routine in research on health effects of pollution and on communication of the health risks and calls for action, as in many other areas of health research and service development. In particular, there is a need for more direct research that engages with the public on communication needs and methods. There are successful examples of such work that can be learned from, particularly in relation to air quality and (in another context) flood risk.
- Ways of communicating risk have differed, in their general approach and in the kinds of information, between pollutants, between health risks from pollution and other health risks and (arguably) between health risks and other risks to public safety. While the diversity of this approach is a good thing, given the importance of context in communication and given the different audiences involved, we do wonder whether there is sufficient awareness across Government of the successes (or otherwise) of risk communication in different areas. The 2014 Government Chief Scientific Adviser's report⁴¹ is an excellent basis for such co-operation, but are enough internal channels of communication in place to share good practice consistently?

Conclusion

The measurement and communication of health risks from pollution is inevitably complex. Interactions can be complex, both between the pollutants themselves and between the various research disciplines that are necessary to cover the wide field. Good progress is being made and must continue to be made, given the level of the threat to the public health and the need to allow desired activities that may pollute, to continue in an appropriate manner. Further opportunities for collaboration and coordination in measurement must, however, be promoted.

To communicate, we need evidence from measurement, but communication is never just a matter of getting the evidence across. Given a good understanding of the audience and the reasons for communication, it is important to realise that psychological insights into communication and behaviour change do not apply only to ways of helping the public to change behaviour, but can also inform the implementation of policy, particularly where there are multiple agents involved. Whatever the audience, effective communication requires trust and trust requires a real and transparent relationship between those concerned.

References

- 1 Particles Retrieval Advisory Group (Dounreay). Meeting reports. 2013. Available from <http://www.sepa.org.uk/regulations/radioactive-substances/nuclear-industry/#fouraa> [Accessed 1 July 2017].
- 2 Dounreay Site Restoration Limited. Particles. Dounreay: Dounreay Site Restoration Limited. Available from <https://dounreay.com/about/decommissioning-projects/particles/> [Accessed 1 July 2017].
- 3 Tyler AN, Scott EM, Dale P, Elliott AT, Wilkins BT, Boddy K, Toole J, Cartwright P. Reconstructing the abundance of Dounreay hot particles on an adjacent public beach in Northern Scotland. *Science of the Total Environment*. 2011;408:4495–4503.
- 4 Darby S. Radiation risks: Appropriate decisions come from valid data, not inaccurate perceptions of risk. *BMJ*. 1999;319(7216):1019-1020.
- 5 Committee on Medical Aspects of Radiation in the Environment (COMARE). Sixth Report: A reconsideration of the possible health implications of the radioactive particles found in the general environment around the Dounreay Nuclear Establishment in the light of the work undertaken since 1995 to locate their source. Chilton: National Radiological Protection Board; 1999. Available from <https://www.gov.uk/government/publications/review-of-radioactive-particles-around-the-dounreay-nuclear-site> [Accessed 1 July 2017].
- 6 Liu C, Lu L, Huang T, Huang Y, Ding L, Zhao W. The Distribution and Health Risk Assessment of Metals in Soils in the Vicinity of Industrial Sites in Dongguan, China. *International Journal of Environmental Research and Public Health*. 2016;13:832.
- 7 Swartjes FA. Human health risk assessment related to contaminated land: state of the art. *Environmental Geochemistry and Health*. 2015;37:651–6.
- 8 Morrison S, Fordyce FM, Scott EM. An initial assessment of spatial relationships between respiratory cases, soil metal content, air quality and deprivation indicators in Glasgow, Scotland, UK: relevance to the environmental justice age. *Environmental Geochemistry and Health*. 2014;36:319–332.
- 9 Jarup L. Hazards of heavy metal contamination. *British Medical Bulletin*. 2003;68:167–182.
- 10 Leake JR, Adam-Bradford A, Rigby JE. Health benefits of 'grow your own' food in urban areas: implications for contaminated land risk assessment and risk management? *Environmental Health*. 2009;8(Suppl 1):S6.
- 11 European Commission. *Science for Environment Policy In-depth Report: Soil Contamination: Impacts on Human Health*. Report produced for the European Commission DG Environment. Bristol: Science Communication Unit, University of the West of England; 2013.

- 12 Tchounwou PB, Yedjou CG, Patlolla AK, Sutton DJ. Heavy Metals Toxicity and the Environment. *EXS*: 2012;101:133–164.
- 13 Gowers AM, Miller BG, Stedman JR. Estimating Local Mortality Burdens associated with Particulate Air Pollution. London: Public Health England; 2014. Available from <https://www.gov.uk/government/publications/estimating-local-mortality-burdens-associated-with-particulate-air-pollution> [Accessed 1 July 2017].
- 14 Ashbolt NJ. (2015) Microbial Contamination of Drinking Water and Human Health from Community Water Systems. *Current Environmental Health Reports*: 2015;2:95–106.
- 15 Drinking Water Inspectorate. What are the drinking water standards? London: Drinking Water Inspectorate; 2017. Available from <http://dwi.defra.gov.uk/consumers/advice-leaflets/standards.pdf> [Accessed 1 July 2017].
- 16 World Health Organization. *Trihalomethanes in Drinking-water. Background document for development of WHO Guidelines for Drinking-water Quality*. Geneva: World Health Organization; 2005.
- 17 EPA Office of Environmental Enforcement. *JOINT POSITION STATEMENT Trihalomethanes in Drinking Water*. Wexford: Environmental Protection Agency; 2011.
- 18 Hoek G, Krishnan RM, Beelen R, Peters A, Ostro B, Brunekreef B, Kaufman JD. Long-term air pollution exposure and cardio-respiratory mortality: a review. *Environmental Health*:2013;12:43.
- 19 Werner D, Valdivia-Garcia M, Weir P, Haffey M. Trihalomethanes formation in point of use surface water disinfection with chlorine or chlorine dioxide tablets. *Water and Environment Journal*: 2016;30:271–277.
- 20 Chief Inspector of Drinking Water. *Drinking water quality in England: The position after 25 years of regulation*. London: Drinking Water Inspectorate; 2015.
- 21 Committee on the Toxicity Chemicals in Food, Consumer Products and the Environment. COT Statement on a SAHSU Study on Chlorination Disinfection By-Products and Risk of Congenital Anomalies in England and Wales. London: Committee on the Toxicity Chemicals in Food, Consumer Products and the Environment; 2008. Available from <https://cot.food.gov.uk/cotstatements/cotstatementsyrs/cotstatements2008/cotdbp200802> [Accessed 1 July 2017].
- 22 Doll R, Hill AB. The mortality of doctors in relation to their smoking habits. *British Medical Journal*: 1954;228(i):1451-1455.
- 23 Doll R, Peto R, Boreham J, Sutherland I. Mortality in relation to smoking: 50 years' observation on male British doctors. *BMJ*: 2004; 328: 1519.
- 24 Munasinghe M. Is environmental degradation an inevitable consequence of economic growth: tunneling through the environmental Kuznets curve. *Ecological Economics*: 1999;29(1):89-109.

- 25 Lora-Wainwright A, Zhang Y, Wu Y, Van Rooij B. Learning to Live with Pollution: The Making of Environmental Subjects in a Chinese Industrialized Village. *The China Journal*: 2012;68:106-124.
- 26 Vanderheiden S. Radical environmentalism in an age of antiterrorism. *Environmental politics*: 2008;17(2):299-318.
- 27 Adami HO, Berry SC, Breckenridge CB, Smith LL, Swenberg JA, Trichopoulos D, Weiss NS, Pastoor TP. Toxicology and epidemiology: improving the science with a framework for combining toxicological and epidemiological evidence to establish causal inference. *Toxicological Sciences*: 2011;122(2):223-234.
- 28 Godleski JJ, Verrier RL, Koutrakis P, Catalano PJ. Mechanisms of Morbidity and Mortality from Exposure to Ambient Air Particles. Boston:Health Effects Institute. Research Report: 91, 2000. Available from <https://www.healtheffects.org/system/files/Godleski.pdf> [Accessed 5 August 2017].
- 29 Schwartz J. Air Pollution and Hospital Admissions for Heart Disease in Eight U.S. Counties. *Epidemiology*: 1999;10(1):17-22.
- 30 Kloog I, Ridgway B, Koutrakis P, Coull BA, Schwartz JD. Long and short-term exposure to PM_{2.5} and mortality. *Epidemiology*: 2013;24:555-561.
- 31 Kloog I, Coull BA, Zanobetti A, Koutrakis P, Schwartz JD. Acute and chronic effects of particles on hospital admissions in New-England. *PLoS ONE*: 2012;7(4):e34664.
- 32 Van Bree L, Marra M, Van Scheindelen HJ, Fischer PH, De Loos S, Buringh E, Rombout PJA. Dose-effect models for ozone. *Toxicology Letters*: 1995;82:317-321.
- 33 Air Quality Expert Group. Ozone in the United Kingdom. 2009. Available from <https://uk-air.defra.gov.uk/assets/documents/reports/aqeg/aqeg-ozone-report.pdf> [Accessed 1 July 2017].
- 34 Department for Environment, Food & Rural Affairs/Department for Transport. UK Plan for tackling roadside nitrogen dioxide concentrations: Technical report. July 2017. Available from https://www.gov.uk/government/uploads/system/uploads/attachment_data/file/632916/air-quality-plan-technical-report.pdf [Accessed 5 August 2017].
- 35 Nurse, P. Ensuring a successful UK research endeavour: A Review of the UK Research Councils. Department for Business, Innovation and Skills. 2015. Available from <https://www.gov.uk/government/publications/nurse-review-of-research-councils-recommendations> [Accessed 1 July 2017].
- 36 Committee on the Medical Effects of Air Pollutants. The Mortality Effects of Long-Term Exposure to Particulate Air Pollution in the United Kingdom. London: Committee on the Medical Effects of Air Pollutants; 2010. Available from <https://www.gov.uk/government/publications/comeap-mortality-effects-of-long-term-exposure-to-particulate-air-pollution-in-the-uk> [Accessed 1 July 2017].

- 37 Miller BG, Hurley JF. Comparing estimated risks for air pollution with risks for other health effects. Research Report TM/06/01. Edinburgh: Institute of Occupational Medicine; 2006. Available from http://www.iom-world.org/pubs/IOM_TM0601.pdf [Accessed 1 July 2017].
- 38 Committee on the Medical Effects of Air Pollutants. Statement on Estimating the Mortality Burden of Particulate Air Pollution at the Local Level. London: Committee on the Medical Effects of Air Pollutants; 2012. Available from http://webarchive.nationalarchives.gov.uk/20140505104658/http://www.comeap.org.uk/images/stories/Documents/Statements/FINAL_Local_mortality_burden_statement_August_2012.pdf [Accessed 1 July 2017].
- 39 Committee on the Medical Effects of Air Pollutants. Comparability of mortality burden estimates for different risk factors. London: Committee on the Medical Effects of Air Pollutants; 2013. Available from <http://webarchive.nationalarchives.gov.uk/20140505104658/http://www.comeap.org.uk/documents/reports/39-page/linking/51-the-mortality-effects-of-long-term-exposure-to-particulate-air-pollution-in-the-united-kingdom> [Accessed 1 July 2017].
- 40 Pope CA, Ezzati M, Dockery DW. Fine-Particulate Air Pollution and Life Expectancy in the United States. *New England Journal of Medicine*: 2009;360:376-386.
- 41 Government Chief Scientific Adviser. Innovation: managing risk, not avoiding it – report. London: Government Office for Science; 2014. Available from <https://www.gov.uk/government/publications/innovation-managing-risk-not-avoiding-it> [Accessed 1 July 2017].
- 42 Academy of Medical Sciences. Enhancing the use of scientific evidence to judge the potential benefits and harms of medicines. London: Academy of Medical Sciences; 2017. Available from <http://acmedsci.ac.uk/policy/how-can-we-all-best-use-evidence> [Accessed 1 July 2017].
- 43 European Food Safety Authority. Revised Draft Guidance on Uncertainty in EFSA Scientific Assessment. 2016. Parma: European Food Safety Authority; 2016. Available from <https://www.efsa.europa.eu/sites/default/files/160321DraftGDUncertaintyInScientificAssessment.pdf> [Accessed 1 July 2017].
- 44 Intergovernmental Panel on Climate Change. Fifth Assessment Report. Geneva: Intergovernmental Panel on Climate Change; 2013-2014. Available from <http://www.ipcc.ch/report/ar5/> [Accessed 1 July 2017].
- 45 Intergovernmental Panel on Climate Change. Guidance Note for Lead Authors of the IPCC Fifth Assessment Report on Consistent Treatment of Uncertainties. Geneva: Intergovernmental Panel on Climate Change; 2010. Available from <http://www.ipcc.ch/pdf/supporting-material/uncertainty-guidance-note.pdf> [Accessed 1 July 2017].
- 46 Intergovernmental Panel on Climate Change. Guidance Note for Lead Authors of the IPCC Fourth Assessment Report on Addressing Uncertainties. Geneva: Intergovernmental Panel on Climate Change; 2005. Available from

- <http://www.ipcc.ch/meetings/ar4-workshops-express-meetings/uncertainty-guidance-note.pdf> [Accessed 1 July 2017].
- 47 Beyth-Marom R. How probable is probable? A numerical translation of verbal probability expressions. *Journal of Forecasting*;1982;1:257–269.
- 48 International Agency for Cancer Research. IARC Monographs Questions and Answers. Lyon: International Agency for Cancer Research; 2015. Available from https://monographs.iarc.fr/ENG/News/Q&A_ENG.pdf [Accessed 1 July 2017].
- 49 McConway, K. Statistics and the media: A statistician’s view. *Journalism*;2015;17:49-65.
- 50 Donnelly, L. Processed meat ranks alongside smoking as major cause of cancer, World Health Organisation says. London: Telegraph; 2015(26 October). Available from <http://www.telegraph.co.uk/news/health/news/11954640/World-Health-Organisation-report-processed-meats.html> [Accessed 1 July 2017].
- 51 Committee on the Medical Effects of Air Pollutants. Review of the UK Air Quality Index. London: Committee on the Medical Effects of Air Pollutants; 2011. Available from <https://www.gov.uk/government/publications/comeap-review-of-the-uk-air-quality-index> [Accessed 1 July 2017].
- 52 Smallbone, KL. Individuals’ interpretation of Air Quality Information: Customer insight and awareness study. Brighton: University of Brighton; 2010. Available from https://uk-air.defra.gov.uk/assets/documents/reports/cat14/1210261047_Individuals_interpretation_of_air_quality_information_customer_insight_&_awareness_study.pdf [Accessed 1 July 2017].
- 53 Smallbone, KL. Individuals’ Interpretation of Air Quality Information: Follow up investigation into the proposed air quality health advice. Brighton: University of Brighton; 2011. Available from https://uk-air.defra.gov.uk/assets/documents/reports/cat14/1210261052_Individuals_interpretation_of_air_quality_information_follow-up_invesigation.pdf [Accessed 1 July 2017].
- 54 Lawther PJ, Waller RE, Henderson M. Air pollution and exacerbation of chronic bronchitis. *Thorax*: 1970;25:525-539.
- 55 Pope CA, Schwartz, J. Time series for the analysis of pulmonary health data. *American Journal of Respiratory and Critical Care Medicine*: 1996;154(6 Pt 2):S229-233.
- 56 Government Office for Science. Code of Practice for Scientific Advisory Committees. London: Government Office for Science; 2011. Available from <https://www.gov.uk/government/publications/scientific-advisory-committees-code-of-practice> [Accessed 1 July 2017].
- 57 Government Office for Science. The Government Chief Scientific Adviser’s Guidelines on the Use of Scientific and Engineering Advice in Policy Making. London: Government Office for Science; 2010. Available from https://www.gov.uk/government/uploads/system/uploads/attachment_data/file/

- 293037/10-669-gcsa-guidelines-scientific-engineering-advice-policy-making.pdf [Accessed 1 July 2017].
- 58 World Health Organisation (Ed.). Air Quality Guidelines Global Update 2005. Copenhagen, Denmark: World Health Organisation Regional Office for Europe; 2006. Available from <http://www.euro.who.int/en/health-topics/environment-and-health/Housing-and-health/publications/pre-2009/air-quality-guidelines.-global-update-2005.-particulate-matter,-ozone,-nitrogen-dioxide-and-sulfur-dioxide> [Accessed 1 July 2017].
- 59 Interdepartmental Group on Costs and Benefits. An Economic Analysis to inform the Air Quality Strategy. Updated Third Report of the Interdepartmental Group on Costs and Benefits (Vol 3). London: TSO (The Stationery Office); 2007. Available from https://www.gov.uk/government/uploads/system/uploads/attachment_data/file/221088/pb12637-icgb.pdf [Accessed 1 July 2017].
- 60 National Audit Office. Policy Development: Improving Air Quality. London: National Audit Office; 2001. Available from <https://www.nao.org.uk/press-release/policy-development-improving-air-quality-2/> [Accessed 1 July 2017].
- 61 Chilton S, Covey J, Jones-Lee M, Loomes G, Metcalf H. Valuation of Health Benefits Associated with Reductions in Air Pollution. London: Defra; 2004. Also available from http://webarchive.nationalarchives.gov.uk/20130402151656/http://archive.defra.gov.uk/environment/quality/air/airquality/publications/healthbenefits/airpollution_reduction.pdf [Accessed 1 July 2017].
- 62 Committee on the Medical Effects of Air Pollutants. Interim statement on quantifying the association of long-term average concentrations of nitrogen dioxide and mortality. London: Committee on the Medical Effects of Air Pollutants; 2015. Available from https://www.gov.uk/government/uploads/system/uploads/attachment_data/file/485373/COMEAP_NO2_Mortality_Interim_Statement.pdf [Accessed 1 July 2017].
- 63 Institute for Environment and Health. Joint Research Programmes on Outdoor and Indoor Air Pollution (Review of Progress, 1999). Leicester: MRC Institute for Environment and Health; 2000. Available from http://www.iehconsulting.co.uk/IEH_Consulting/IEHCPubs/AirPollution/sr4.pdf [Accessed 1 July 2017].
- 64 Department of Health. Air pollution research funded by the Department of Health. London: Department of Health; 2003. Available from <http://webarchive.nationalarchives.gov.uk/20061003091600/http://www.dh.gov.uk/assetRoot/04/07/06/08/04070608.pdf> [Accessed 1 July 2017].
- 65 Pidgeon N, Hood C, Jones D, Turner B, Gibson R. Risk perception. In: Report of a Royal Society Study Group, *Risk: Analysis, perception and management*. London: The Royal Society; 1992. p. 89-134.
- 66 Gifford R. The dragons of inaction: Psychological barriers that limit climate change mitigation and adaptation. *American Psychologist*. 2011;66:290-302.

- 67 Corner A, Lewandowsky S, Phillips M, Roberts O. *The Uncertainty Handbook: A Practical Guide for Climate Change Communicators*. Bristol: University of Bristol; 2015.
- 68 Kahneman D. *Thinking, fast and slow*. New York, NY: Farrar, Straus & Giroux; 2011.
- 69 Slovic P, Finucane ML, Peters E, MacGregor DG. Risk as analysis and risk as feelings. *Risk Analysis*: 2004;24,1–12.
- 70 Damasio A. *Descartes' Error*. London: Vintage Books; 2006.
- 71 Hollands G, French D, Griffin S, Prevost T, Sutton S, King S, Marteau T. The impact of communicating genetic risks of disease on risk reducing health behaviour: systematic review with meta-analysis. *BMJ*: 2016;352:i1102
- 72 French DP, Cameron E, Benton JS, Deaton C, Harvie M. Can Communicating Personalised Disease Risk Promote Healthy Behaviour Change? A Systematic Review of Systematic Reviews. *Annals of Behavioral Medicine*: 2017; doi:10.1007/s12160-017-9895-z.
- 73 Marteau TM, Ogilvie D, Roland M, Suhrcke M, Kelly MP. Judging nudging: can nudging improve population health? *BMJ*: 2011;342:d228.
- 74 French DP, Cameron E, Benton JS, Deaton C, Harvie M. Can Communicating Personalised Disease Risk Promote Healthy Behaviour Change? A Systematic Review of Systematic Reviews. *Annals of Behavioral Medicine*: 2017; doi:10.1007/s12160-017-9895-z.
- 75 Joffe H. The power of visual material: Persuasion, emotion and identification. *Diogenes*: 2008;55(1),84-93.
- 76 Joffe H, Elsey, JWB. Free Association in Psychology and the Grid Elaboration Method. *Review of General Psychology*: 2014;18(3):173-185.
- 77 Joffe H, Smith N. City dweller aspirations for cities of the future: How do environmental and personal wellbeing feature? *Cities*: 2016;59:102-112.
- 78 Hammond D, Fong GT, McDonald PW, Brown KS, Cameron R. Graphic cigarette package warning labels do not lead to adverse outcomes: Evidence from Canadian smokers. *American Journal of Public Health*: 2004;94(8):1442-1445.
- 79 Porzig-Drummond R, Stevenson R, Case T, Oaten O. Can the emotion of disgust be harnessed to promote hand hygiene? Experimental and field-based tests. *Social Science and Medicine*: 2009;68:1006-1012.
- 80 Kocher KW. *The Stop Aids Story 1987-1992*. Bern, Switzerland: Stop AIDS Campaign of the Swiss AIDS Foundation and the Federal Office for Public Health; 1993.
- 81 Kocher KW. *The Stop Aids Story Part 2, 1993-95*. 1996: Bern, Switzerland: Stop AIDS Campaign of the Swiss AIDS Foundation and the Federal Office for Public Health; 1996.
- 82 Joffe H. *Risk and 'the Other'*. Cambridge: Cambridge University Press; 1999.
- 83 Uzzell DL. The psycho-spatial dimension of global environmental problems. *Journal of Environmental Psychology*: 2000;20(4):307–318.

- 84 Michie, S. West, R. Behaviour change theory and evidence: a presentation to Government. *Health Psychology Review*: 2013;7:1-22.
- 85 Hollands GJ, French DP, Griffin SJ, Prevost AT, Sutton S, King S, Marteau TM. The impact of communicating genetic risks of disease on risk-reducing health behaviour: systematic review with meta-analysis. *BMJ*: 2016;352:i1102.
- 86 Gigerenzer G, Gaissmeier W, Kurz-Milcke E, Schwartz LM, Woloshin S. Helping Doctors and Patients Make Sense of Health Statistics. *Psychological Science in the Public Interest*: 2007;8:53–96.
- 87 O'Neill, O. What we don't understand about trust. Video lecture available from https://www.ted.com/talks/onora_o_neill_what_we_don_t_understand_about_trust [Accessed 1 July 2017].
- 88 Spiegelhalter D. Trust in Numbers. *Journal of the Royal Statistical Society A*: 2017;180:in press.
- 89 Kocher KW. *The Stop Aids Story 1987-1992*. Bern, Switzerland: Stop AIDS Campaign of the Swiss AIDS Foundation and the Federal Office for Public Health; 1993.
- 90 Kocher KW. *The Stop Aids Story Part 2, 1993-95*. 1996: Bern, Switzerland: Stop AIDS Campaign of the Swiss AIDS Foundation and the Federal Office for Public Health; 1996.
- 91 Joffe H. *Risk and 'the Other'*. Cambridge: Cambridge University Press; 1999.
- 92 Uzzell DL. The psycho-spatial dimension of global environmental problems. *Journal of Environmental Psychology*: 2000;20(4):307–318.

Acknowledgements

Acknowledgements

The production of this report has been a collaborative process, calling on the expertise of many contributors in academia, government, the civil service and business. I thank all of those who provided text and statistics, participated in workshops, and gave advice. I hope this report stimulates further conversation about all pollutants and how we may better understand and respond to the threat they pose to human health.

Firstly, I thank my Editor-in-Chief, Andrew Dalton, for his diligence and hard work throughout the 18 month production process. Andrew has brought together experts from many areas and skilfully assisted their collaboration. He has also co-authored and co-edited chapters in this report. I also thank my Project Manager and Editor, Orla Murphy for her policy input, editing skills and workshop facilitation.

In particular, I would like to thank the Chapter Leads and all their co-authors and contributors, who have produced impressive work to inform my recommendations.

Chapter Leads

Chapter 2, Pollution from the Health and Care System

Professor David Pencheon, Honorary Professor, Health and Sustainable Development, University of Exeter Medical School

Chapter 3, 21st century chemicals

Professor Timothy W. Gant, Head of the Department of Toxicology in the Centre for Radiation, Chemicals and Environmental Hazards, Public Health England, and Visiting Professor (Health and Medical Sciences) of the University of Surrey.

Chapter 4, New horizons

Professor Alistair Boxall, Professor in Environmental Science, University of York

Chapter 5, Health economics of interventions to reduce pollution

Dr Laure de Preux, Assistant Professor in Economics, Imperial College Business School

Chapter 6, Pollution and inequality

Professor Gordon Walker, Lancaster Environment Centre, Lancaster University

Chapter 7, Environmental health - response to pollution

Dr Naima Bradley, Head of Environmental Hazards and Emergencies Department, Public Health England

Chapter 8, Pollution - data, surveillance and health impacts

Prof Paul Elliott, Chair in Epidemiology and Public Health Medicine, MRC-PHE Centre for Environment and Health, Department of Epidemiology and Biostatistics, School of Public Health, Imperial College London

Chapter 9, Measurement and communication of health risks from pollution

Professor Kevin McConway, Emeritus Professor of Applied Statistics, Open University

The authors of Chapter 8 would like to thank Ovnair Sepai, Giovanni Leonardi, and Helen Crabbe at Public Health England; Fuyuen Y. Yip and Holly Wilson at the US Centers for Disease Control and Prevention; Wendy McKelvey at the New York City Department of Health and Mental Hygiene for providing additional information for Chapter 8. Professor Paul Elliot would particularly like to thank colleagues at MRC-PHE Centre, SAHSU, UK MED-BIO and HPRU.

Dr Heather Wilson co-authored Chapter 9 of this report. I would like to acknowledge that Dr Walton's post was part-funded by the National Institute for Health Research Health Protection Research Unit in Health Impact of Environmental Hazards at King's College London in partnership with Public Health England.

Reviewing text and providing specialist advice

I thank all those who gave their time to comment on draft text. In particular, colleagues at Department for Environment, Food and Rural Affairs and Sustainable Development Unit gave assistance and consideration including Shaun Gallagher, Director, Harriet Wallace, Deputy Director, Air Quality and Industrial Emissions and Environmental Quality, and Gabrielle Edwards, Deputy Director, Chemicals, Pesticides and Hazardous Waste all of Department for Environment, Food and Rural Affairs; Jerome Baddley, Acting Director and Rick Lomax, Sustainability Projects Analyst and Programme Manager, both of Sustainable Development Unit.

I also thank Professor Paul Cosford CB, Director for Health Protection and Medical Director, Public Health England, Dr Jonathan Graves, Senior Policy Officer at Department of Health and Social Care and Ms Vivienne Parry, science journalist and Head of Engagement at Genomics England for their valuable comments.

Many people have kindly advised my Editor-in-Chief and team but my special thanks go to those who provided their expert support through several stages of report production; Professor Stephen Holgate, Medical Research Council Clinical Professor of Immunopharmacology, University of Southampton, Professor Frank Kelly,

Professor of Environmental Health, King's College London and Dr Giovanni Leonardi, Head of Epidemiology Group at Centre for Radiation, Chemical and Environmental Hazards, Public Health England.

Special meetings and workshops

I thank The Royal Society for playing a special role, bringing together colleagues with a particular interest in air pollution for an informative discussion. My thanks to Emma Woods, Head of Policy, Wellbeing at The Royal Society for convening such a successful event and to Professor Jennifer Rubin, Director of the Policy Institute and Professor of Public Policy, King's College London for facilitating the complex discussion so ably.

I am always impressed by the calibre of young public health professionals I meet through the course of my work. My thanks to Ms Karen Buckley, Public Health Specialty Registrar, Walsall Hospitals NHS Trust and Dr Bilal Adam, National Medical Director's Clinical Fellow, Public Health England, for facilitating at the workshop to explore the format and content of this report.

Report production and promotion

I thank Alix McCulloch, Senior Account Manager, APS Group for her valuable advice and hard work to meet difficult deadlines. I thank my media colleagues at Department of Health and Social Care, particularly David Betros-Matthews and Naomi Stanley, for their work to bring my report to the attention of healthcare professionals, policy makers and the public.

My private office

As ever, I thank Hasim Miah, my Diary Manager, for his sterling support to ensure that key meetings of senior stakeholders are timely and well-briefed. I thank Jonathan Pearson-Stuttard, Specialist Registrar in Public Health, Imperial College London and Editor-in-Chief of my annual report 2018 for his research and briefings. I thank Hugo Jones, formerly my Head of Office, for providing excellent drafting skills and policy input. My Assistant Private Secretaries (past and present), have worked hard to ensure this report is successful and informed by the wider policy context; I thank in particular Helen Farmer and Nicholas Gunning.

Annual Report of the Chief Medical Officer 2018

Annexes 1 – 4

Annex 1 – Outdoor Air Pollution

Unlike smoking, air pollution is not a lifestyle choice but an involuntary environmental exposure, which can affect all of the population from the womb to death. Air pollution results from a complex mixture of thousands of pollutants. This chemical mixture includes particulate matter (PM) coated with combustion-related chemicals, and gases such as oxides of nitrogen (NO_x, including NO₂) and volatile organic compounds (VOCs) as well as “secondary” pollutants such as ozone (O₃) and particles derived from primary pollutants. Health effects are measured using a marker of pollution e.g. particles of diameter <10µm (PM₁₀) or <2.5µm (PM_{2.5}), NO₂ and O₃. Commonly used indicators are traffic density at the nearest road or residential distance from busy roads. Background pollutant levels increase markedly with low wind speeds resulting in air pollution episodes lasting days - weeks. On a daily basis, extremely high pollutant concentrations accumulate within urban environments adjacent to busy roads and traffic intersections. Outdoor pollutants also penetrate indoors extending daily exposure to 24 hours.

While the risks of air pollution to adverse health in Britain were thought to have been solved by the Clean Air Acts of the 1950s and 1960s, in the UK, it is contributing to 40,000 excess deaths each year, considerable morbidity and leading to a total annual cost to the economy of around £27 billion. The adverse health effects produced by ambient air pollution cannot be attributed to a single pollutant but pollutants act together by interrelated mechanisms causing oxidative stress, tissue injury, local and systemic inflammation. Fine particles can also cross the lung into the circulation and via the nasal mucosa where the olfactory nerves pass into the brain producing more widespread toxic effects.

Effects of pollutants depend on health outcomes, timescale (e.g. acute versus long-term effects), underlying individual susceptibilities and the nature and concentrations of co-pollutants. Examples of established associations between frequently used markers of ambient air pollution and various respiratory health outcomes are shown in the table. Markers of air pollution are often correlated with each other and the health effects are frequently nonspecific, therefore specific effects cannot be easily assigned to single pollutants.

Short-term effects: The daily number of deaths, mainly from cardiovascular (CHD, arrhythmia and stroke) and respiratory diseases (COPD and pneumonia), tracks with daily fluctuations in air pollution. The daily variation in urban pollution also increases emergency hospital visits and admissions due to respiratory diseases such as asthma and COPD. Patients with asthma also suffer more on or after days with higher pollution levels.

Long-term consequences: Long-term or lifetime exposure to ambient pollutants have pathological effects that contribute to a variety of chronic diseases. The overall effects of pollution on mortality are far larger than the fraction attributed to acute

exposures. In general, respiratory disease is less often the cause of death than cardiovascular disease, and the two are often combined as cardiopulmonary mortality. In the entire Medicare population of the US, there was significant evidence of adverse effects related to exposure to PM_{2.5} and ozone at concentrations below current national standards, with adverse effects being most pronounced among racial minorities and people with low income.

Air pollution influences the developing foetus, increasing the risk of premature birth, decreasing birthweight, promoting intrauterine growth retardation, reducing lung function at birth. Since infant's and children's lungs are still growing and maturing, any deficit in growth will have an impact for the whole of the child's life. Many cross-sectional studies have reported lower lung volumes in children living in more polluted areas and longitudinal studies e.g. the University of Southern California (USC) Children's Health Study show this extends to adult life. Living close to a busy road increases the risk of developing asthma in childhood, even when confounding factors are taken into account. The contrasting lack of association between asthma onset and urban background pollution, and the strong associations between proximity to traffic arteries and asthma suggests that those pollutants occurring at very high concentrations along street corridors play a role in the genesis of asthma. Many studies have reported associations between lung function and pollution and a few also suggest that air pollution may also contribute to the development of COPD.

The IARC list diesel exhaust as a Group 1 carcinogen. Particles, in particular those from diesel engines, are loaded with carcinogens. Lung cancer incidence increases by 8% per 10µg/m³ increase in PM_{2.5} and 3.7% per 10µg/m³ increase in NO_x. Air pollution has also been associated with a range of other disorders including Types 1 and 2 diabetes, hypertension, premature skin aging increased blood coagulation (and DVT) and dementia. Causality for pollution's effect on dementia is revealed by accelerated loss of cognition in those with the E*4 variant of the APOE gene, the largest known genetic risk factor for late-onset sporadic Alzheimer's disease .

Table A1.1 Examples of established associations between frequently used markers of ambient air pollution and various respiratory health outcomes

Marker of air pollution	Questionnaire-based respiratory health data	Objective respiratory markers	Biomarkers of effect	Health system use	Acute effects on mortality	Long-term effects: mortality/life expectancy
Particulate Matter (PM)	Respiratory symptoms	Diminished lung function, impaired growth of lung function	Airway inflammation, chronic lung disease	Emergency admissions for respiratory diseases, asthma	Increase in daily mortality	Increased mortality from cardiopulmonary diseases
Ozone (O ₃)	Respiratory symptoms	Diminished lung function	Airway inflammation	Emergency admissions for asthma	Increase in daily mortality	Suggestive for respiratory death
Nitrogen Oxides (NO _x)	Respiratory symptoms	Increased bronchial reactivity, impaired growth of lung function	Airway inflammation alteration in lung immune defences	Emergency admissions for respiratory diseases	Increase in daily mortality	Increased long-term mortality from cardiopulmonary diseases

Annex 2 – Chapter 05 Literature Review

We searched for various combinations of terms in PubMed using MeSH terms and key words. The results are reported in Table A.1. We complemented the searches below using Google and Google Scholar.

We considered peer-reviewed publications, reports, policy briefs, and working papers. We focused on the UK, but also similar countries in their level of development.

We excluded the following topics:

- Economic evaluations focusing on CO2
- Economic evaluations of Chinese cities
- Studies assessing the impact of pollutants on health
- Smoking as a source of pollution

Table A2.1 Search results

Search Term	Count of Number of results	Average of Number of results²
("Inhalation Exposure/economics"[MeSH] AND "Inhalation Exposure/prevention and control"[MeSH])	1	1
("air pollutants"[MeSH Terms] AND "policy"[MeSH Terms]) AND "costs and cost analysis"[MeSH Terms]	4	12
("air pollutants"[MeSH Terms] AND ("health"[MeSH Terms] OR "health"[All Fields])) AND ("economics"[Subheading] OR "economics"[All Fields] OR "economics"[MeSH Terms]) (Called SearchApp01_P*.pdf)	19	487
("environmental policy"[MeSH Terms] AND "health"[MeSH Terms]) AND ("costs and cost analysis"[MeSH Terms] OR ("costs"[All Fields] AND "cost"[All Fields] AND "analysis"[All Fields]) OR "costs and cost analysis"[All Fields] OR "costs"[All Fields])	2	7
("Greenhouse Effect/economics"[MeSH] AND "Greenhouse Effect/prevention and control"[MeSH]) AND ("health"[MeSH Terms] OR "health"[All Fields])	1	4
Air Pollution, Indoor/analysis[MeSH] AND "Air Pollution, Indoor/economics"[MeSH] AND "Air Pollution, Indoor/prevention and control"[MeSH]	3	4
Air Pollution, Radioactive/economics[MeSH] AND "Air Pollution, Radioactive/prevention and control"[MeSH]	1	13
Cost-Benefit Analysis/economics[MeSH] AND "Environmental Pollution"[MeSH]	1	11
Environmental Policy/economics[MeSH]	2	160
Environmental Policy/economics[MeSH] AND ("health impact assessment"[MeSH Terms] OR ("health"[All Fields] AND "impact"[All Fields] AND "assessment"[All Fields]) OR "health impact assessment"[All Fields])	1	2
environmental policy[MeSH Terms] AND "health"[MeSH Terms]	2	106
Environmental Restoration and Remediation/economics[MeSH]	1	213
Food Contamination/economics[MeSH] AND "Food Contamination/prevention and control"[MeSH]	8	46
Greenhouse Effect/economics[MeSH] AND ("insurance benefits"[MeSH Terms] OR	1	4

Search Term	Count of Number of results	Average of Number of results²
("insurance"[All Fields] AND "benefits"[All Fields]) OR "insurance benefits"[All Fields] OR ("health"[All Fields] AND "benefit"[All Fields]) OR "health benefit"[All Fields])		
Maternal Exposure/economics[MeSH] AND "Maternal Exposure/prevention and control"[MeSH]	1	2
Occupational Exposure/economics[MeSH] AND "Occupational Exposure/prevention and control"[MeSH]	1	38
Radiation Exposure/economics[MeSH] AND "Radiation Exposure/prevention and control"[MeSH]	2	32
Tobacco Smoke Pollution/economics[MeSH] AND "Tobacco Smoke Pollution/prevention and control"[MeSH]	3	42
Water Pollution, Chemical/economics[MeSH] AND "Water Pollution, Chemical/prevention and control"[MeSH]	1	32
(("environment"[MeSH Terms] AND "health"[MeSH Terms]) AND ("costs and cost analysis"[MeSH Terms] OR ("costs"[All Fields] AND "cost"[All Fields] AND "analysis"[All Fields]) OR "costs and cost analysis"[All Fields] OR "costs"[All Fields])) (Called SearchApp02_P*.pdf)		532
((cost*[Title]) AND pollut*[Title/Abstract]) AND health (Called SearchApp03_P*.pdf)		165

Keywords used on Google and Google Scholar

Economic cost of pollution impacts health / Air pollution cost health / Health pollution cost / Economic cost of air pollution on Health / Health economic cost of pollution assessment / Health based economic assessment air pollution / Social cost of air pollution / Societal cost of air pollution / Economic consequences of air pollution / Health impacts of air pollution / Air pollution cost / Cost and benefits of air quality on the health cost of pollution / Economic valuation of air pollution economic cost on public health / Measuring health cost induced by pollution / Public health impact of air pollution, economic assessments / Risk assessment of air pollution / Benefits on health from reducing air pollution / Health cost externalities of air pollution / Health impact and cost of pollution / Cost efficiency and health benefit approach to improve air quality / Valuing the cost of air pollution on health / Reducing air pollution economic benefits on health.

Environmental policies evaluations / Air quality policies CBA / Tackling air pollution / Air pollution control strategies / Air quality improvements / Policies to address air pollution / Policies to abate emissions / Public health impacts of city policies to reduce climate change / Policies to reduce air pollution emissions / Estimation of pollution policies tackle climate change / Climate policies impact on health / Assessing the public health impacts of urban air pollution european cities / Relationship environmental policies and air quality / Urban air quality improvement policies / Applying policy and health effects of air pollution / Transport policies reducing air pollution / Cities environmental policies / vehicle policies and air quality / Health benefits of air pollution policies / cars emissions impacts on human health / Air pollution effect / Tackling air pollution / Improve air quality UK / Benefits health congestion charge London / Cost policies reduce air pollution / Air pollution public health policies economic cost / Economic valuation of environmental policies in cities / Air pollution and transport health impacts.

Figure A2.1 Using Ovidsp, selecting Embase and Medline

18	▶ (cost* and health and pollut*).sh.	70	Advanced
19	▶ pollut*.af. and cost*.sh. and health.sh.	168	Advanced
20	▶ (health and cost* and environment*).sh.	337	Advanced
21	▶ (health and cost and environment*).sh. and intervention.af.	2	Advanced
22	▶ (cost* and health).kw. and pollut*.sh.	13	Advanced
23	▶ cost*.kw. and health.sh. and Policy.sh. and pollut*.af.	0	Advanced
24	▶ 18 or 19 or 20 or 21 or 22 or 23	453	Advanced

Annex 3 – Chapter 08 Table A3.1

Table A3.1 Examples of data which provide information about environmental pollution

Theme	Dataset	Resolution	Geographical extent	Data Type	Provider	How to obtain the data & comments
Land usage	Land Cover Map	25m x 25m	Great Britain	Map	Centre for Ecology & Hydrology (CEH)	Under license from CEH Data Licensing Team https://www.ceh.ac.uk/services/land-cover-map-2015#form
Land usage	CORINE Land Cover	100m x 100m	EU	Map	European Environment Agency (EEA)	Freely available - see https://www.eea.europa.eu/publications/COR0-landcover
Land usage	Agricultural usage of land	2km x 2km	England	Map	Defra Agricultural Census	Under license to UK Academic Sector from EDINA http://agcensus.edina.ac.uk/
Land usage	Tree cover	Electoral Ward	Greater London	Online Map	The Greater London Authority (Mayor of London) and the Geoinformation Group	Interactive map at https://www.london.gov.uk/what-we-do/environment/parks-green-spaces-and-biodiversity/parks-and-green-spaces/mayors-street-tree
Ordnance survey details incl. greenspace and road and water networks	MasterMap	1:1250 vector data	Great Britain	Map	Ordnance Survey	Under license from Ordnance Survey, some features only available under academic license https://www.ordnancesurvey.co.uk/business-and-government/products/mastermap-products.html

Meteorology	Hourly meteorological data	x,y locations of MET stations	Great Britain	Measurements	MET Office (supplied by Centre for Environmental Data Analysis)	Under license from the MET office
Air pollution	Particulate (PM ₁₀ , PM _{2.5}) and gaseous ((NO ₂ , CO, NO _x , O ₃) air pollution concentrations	x,y locations of Automatic Urban and Rural Monitoring Network stations	United Kingdom	Measurements	Department for Environment Food & Rural Affairs	Freely available under the Open Government License- see https://uk-air.defra.gov.uk/data/
Air pollution	NO ₂ , CO, NO _x , O ₃ , SO ₂ , Benzene, PM ₁₀ , PM _{2.5}	1km x 1km	United Kingdom	Map	Department for Environment Food & Rural Affairs	Maps available on request: Carol.Hryniewicz@defra.gsi.gov.uk
Air pollution	Historic Black smoke (BS) & sulphur dioxide (SO ₂) concentrations	1km x 1km	Great Britain	Modelled	CHESS – funded by Wellcome Trust, grant 075883	Modelled for 1962, 1971, 1981, 1991 (7, 17), further back in time than available from Defra. Available by contacting the Environmental Exposure Group; http://www.sahsu.org/content/environmental-exposures-group

Air pollution	PM, NO ₂ , NO _x , Roads nearby, Traffic intensity, Metals in PM	Addresses	EU	Modelled	ESCAPE and TRANSPHORM – both funded under the EU 7 th Framework Programme	Modelled for the European Study of Cohorts and Air Pollution Effects (ESCAPE) research project (18, 19) and metals for Transport related Air Pollution and Health impacts (TRANSPHORM) (20). Available by contacting the Environmental Exposure Group; http://www.sahsu.org/content/environmental-exposures-group
Air pollution	NO ₂ concentrations	200m x 200m	Great Britain	Modelled	ESCAPE – funded under the EU 7 th Framework Programme	Modelled for a research project for 1991, 2001, 2009 at finer resolution than Defra data and further back in time (21). Available by contacting the Environmental Exposure Group; http://www.sahsu.org/content/environmental-exposures-group
Light pollution	Light emissions	200m x 200m	EU	Modelled	MANTLE - funded under the EU 5 th Framework Programme (22)	Available by contacting the Environmental Exposure Group; http://www.sahsu.org/content/environmental-exposures-group
Heavy metals in soil	Lead, cadmium concentrations in soil	100m x 100m	England & Wales		British Geological Survey	Under license from the British Geological Survey. Four surveys were conducted and data covers 1978-2012 depending on survey. Interactive map at http://mapapps.bgs.ac.uk/londonearth/londonearth.html

EMF	Overhead power lines incl. power output (kV)	Lines	England & Wales	Map location	National Grid	Under license from the National Grid – available via http://www2.nationalgrid.com/uk/services/land-and-development/planning-authority/shape-files/
EMF	Mobile phone masts	Sites	Great Britain	x,y co-ordinates	Mobile Phone providers	Obtained on request with permission to use for a research project to model power density at addresses near mobile phone masts using input data from mobile phone providers (23))
Water	Concentrations of chlorination disinfection by-products and other contaminants	Water supply zones	England	Modelled	Measurement data conducted under Water Supply (Water Quality) Regulations	Summary of tests for each water company available from the Drinking Water Inspectorate http://www.dwi.gov.uk/ . Modelled at water supply zone to provide information about population exposures for a specific research projects (e.g. Nieuwenhuijsen et al. 2008 (24))
Waste	Public register of Environment Agency Licenses for potential releases of pollutants	Site postcode	England	Type of release permitted	Environment Agency	Searchable by postcode and by local authority https://environment.data.gov.uk/public-register/view/index - gives information per permit, not aggregate or mapped information
Waste	Landfill, Incinerator and Biocomposting site locations	Location	England	x,y coordinates	Environment Agency	Obtained on request with permission to use for a research project

Waste	Daily total dust, SO ₂ , NO _X ; 6-monthly dioxin & metals emissions from municipal waste incinerators	x,y coordinates of incinerators	Great Britain	Measurements	Environment Agency	Obtained on request with permission to use for a research project
Radon	Radon concentrations	1km x 1km	England & Wales	Modelled	Public Health England	Interactive map at http://www.ukradon.org/information/ukmaps
Noise	Aircraft noise around major UK airports	10m x 10m grids	Major UK airports	Modelled	Civil Aviation Authority	Obtained on request with permission to use for a research project
Noise	Road and railway noise	Addresses	Major conurbation areas	Modelled	Defra (supplied by Extrium)	Searchable map available from http://www.extrium.co.uk/noiseviewer.html
Noise	Road traffic noise	Postcode centroids	Great Britain (CNOSSOS -EU) and London (Tranex)	Modelled	BioSHaRE - funded under the EU 7 th Framework Programme (25)	Models available via http://www.sahsu.org/content/data-download - can be run with appropriate input data to obtain estimates at specific postcodes

Annex 4 – Chapter 08 Table A4.1

Table A3.1 Details of the main health datasets and data providers in England

Data provider	Dataset	Coverage	Time period	Number of annual records	Year
<u>Office for National Statistics (ONS)</u>	Vital Statistics				
	<i>Births</i>	All registered (England & Wales)	1850 -	698k	2015
	<i>Stillbirths</i>	All registered (England & Wales)	1927 -	3k	2015
	<i>Deaths</i>	All registered (England & Wales)	1838 -	530k	2015
	NN4B (NHS Numbers for Babies)				
National Institute for Health Research (NIHR)	Clinical Practice Research Datalink (CPRD)	All patients registered at general practices contained in CPRD (subset of all practices in the UK), who have not dissented from secondary use of GP patient data (UK)	1987 -	14M	2015
	<i>Prescribed Primary Care drugs</i>	<i>Selected GP practices (see above)</i>			
	<i>Administered Hospital drug</i>	<i>Linked to NHS.Digital data (see below)</i>			
	<i>Laboratory data</i>	Primary care data from 674 practices in the UK	1987 -		
	<i>Consultations</i>	Primary care data from 674 practices in the UK	1987 -		
	<i>GP and hospital coded disease data</i>	<i>Linked to NHS.Digital data (see below)</i>	1997/2003 -		
	<i>Cancer & Disease Registers</i>	<i>Linked to PHE and MINAP data (see below)</i>	1190/2003 -		
<u>NHS.Digital</u>	Hospital Episode Statistics (HES)				

	HES - Admitted Patient Care	NHS hospitals and NHS commissioned activity (England)	1989 -	18,2M FCEs, 15.5M FAEs	2013 /14
	HES – Outpatients	NHS hospitals and NHS commissioned activity (England)	2003/04 -	82.1M	2013 /14
	HES - Adult Critical Care	NHS hospitals and NHS commissioned activity (England)	2008/09 -	250k	2013 /14
	HES - A&E Attendance	NHS hospitals and NHS commissioned activity (England)	2007/08 -	18.5M	2013 /14
	Patient Reported Outcome Measures	NHS hospitals and NHS commissioned activity of 4 common elective surgeries	2009 -	779k	2013 /14
	Mental Health & Learning Disability Data Set	NHS-funded treatment from all specialist practitioners (England)	2003-	1M/month	
	Maternity and Children's Data Sets		2014 -		
	Diagnostic Imaging Dataset	Any NHS-funded diagnostic imaging tests/activity (England)	2012 -	40M	2014
	Improving Access to Psychological Therapies	England	2008 -	1M	
	National Renal Data Set	England	2009 -		
	<i>Prescribed Primary Care drugs</i>	All prescriptions – generics and/or branded products issued in primary care		48M	2016
	<i>Administered Hospital drug</i>	Derived from IMS Health Hospital Pharmacy Audit Index database, covering 99 per cent of NHS beds across England, and data from the Prescription Services Division of			

		the NHS Business Services Authority (BSA)			
Public Health England (PHE)	Cancer registries	All identified cancer cases (England)	1990-2013	10M	2013
	National Congenital Anomaly and Rare Disease Registration Service (NCARDRS)		2017-		
<u>British Isles Network of Congenital Anomaly Registers (BINOCAR)</u>	Congenital Anomaly Registers (now part of NCARDRS)	Northern region (NorCAS), West Midlands (WMCAR), Wessex (WANDA), East Midlands & South Yorkshire (EMSYCAR), Oxfordshire, Berkshire & Buckinghamshire (CAROBB), South West region (SWCAR) and Yorkshire & Humber region (YHCAR)	1985/2011 - 2017	381k	2012
Department of Health	Termination of Pregnancy	England and Wales	1968 -	190k	2016
<u>UK Data Service</u>	1946 Birth Cohort Study	England, Scotland, Wales and Northern Ireland	1946 -	5k	
	1958 National Child Development Study	England, Scotland & Wales	1958 -	17k	
	1970 British Cohort Study	England, Scotland, Wales and Northern Ireland	1970 -	17k	
	Adult Dental Health Survey (ADHS)				
	Avon Longitudinal Study of Parents and Children (ALSPAC)	Bristol area	1991 -	14k	
	English Longitudinal Study of Ageing (ELSA)	Representative sample of the English population aged 50 and older	2002 -	10k	2014 -15

	Health and Lifestyle Survey (HALS)	12,672 addresses were selected from the electoral rolls of 198 randomly selected constituencies, including 7,414 visited by a nurse who carried out various physiological measurements and 6,572 returned self-completion questionnaires	1984/85 1991/92	9k 6k	1984 /85 1991 /92
--	------------------------------------	--	--------------------	----------	----------------------------

MINAP: Myocardial Ischaemia National Audit Project; FCE: finished consultant episode; FAE: finished admission episode; M million; k thousand