



UNIVERSITY OF LEEDS

This is a repository copy of *Real World Emissions Performance of a HDD Truck with Urea SCR NOx Control*.

White Rose Research Online URL for this paper:
<http://eprints.whiterose.ac.uk/160529/>

Version: Accepted Version

Conference or Workshop Item:

Andrews, GE orcid.org/0000-0002-8398-1363, Li, H orcid.org/0000-0002-2670-874X, Hadavi, AS et al. (2 more authors) Real World Emissions Performance of a HDD Truck with Urea SCR NOx Control. In: 5th International Exhaust Emissions Symposium, 19-20 May 2016, Bielsko-Biala, Poland.

This presentation is protected by copyright. This is an author produced version of a conference presentation, given at the 5th International Exhaust Emissions Symposium. Uploaded in accordance with the publisher's self-archiving policy.

Reuse

Items deposited in White Rose Research Online are protected by copyright, with all rights reserved unless indicated otherwise. They may be downloaded and/or printed for private study, or other acts as permitted by national copyright laws. The publisher or other rights holders may allow further reproduction and re-use of the full text version. This is indicated by the licence information on the White Rose Research Online record for the item.

Takedown

If you consider content in White Rose Research Online to be in breach of UK law, please notify us by emailing eprints@whiterose.ac.uk including the URL of the record and the reason for the withdrawal request.



eprints@whiterose.ac.uk
<https://eprints.whiterose.ac.uk/>

Real World Emissions Performance of a HDD Truck with Urea SCR NOx Control

**Gordon E. Andrews, Hu Li, Ali S. Hadavi, Buland Dizayi and
Alison S. Tomlin**

Clean Combustion Group
School of Chemical and Process Engineering
University of Leeds, Leeds, LS2 9JT, UK.
<profgeandrews@hotmail.com>

Contents

- 1. Air quality issues and Real Driving Emissions (RDE) in urban areas of cities**
- 2. Factors that influence RDE**
- 3. Experimental equipment**
- 4. HDD truck RDE test for Euro V with SRC**

Real Driving Emissions (RDE) - 1

The current appalling press regarding RDE shows a lack of understanding of the issue and an industry that has not got its voice across to the public.

The VW issue in the press has been more about vehicles with higher emissions in RDE than on test cycles, which has been the situation since emissions regulations came in and applies equally well to SI engines as diesel, as I will show in this lecture.

Whether VW have 'cheated' and made the RDE worse relative to the test cycle, is a separate issue, but the RDE would have been higher than on the test cycle irrespective of any RDE calibrations that were different to those on the test cycle.

It is my view that congested traffic is a key feature of RDE.

Real Driving Emissions (RDE) - 2

My research group on RDE at Leeds University have over the last 12 years published over 40 SAE papers on RDE and why they are higher than on test cycles.

RDE higher than on test cycles applies to all vehicles SI and diesel and for SI vehicles the RDE effect is closely related to longer cold start in RDE and higher acceleration rates and more stop/starts, as I will show in this presentation.

Modern Euro 6 diesels with particle filters have no real world issues with PM emissions and yet SI engines without a particle trap are now emitting more PM in RDE than diesels with particle traps fitted.

The major RDE effect for diesels is on NO_x and CO₂ and with catalysts to control NO_x, either NSR or Urea SCR, the catalyst has to be above about 200°C to be active and the lower temperatures of diesel exhausts make this difficult, as I will illustrate for a HDD truck RDE journey.

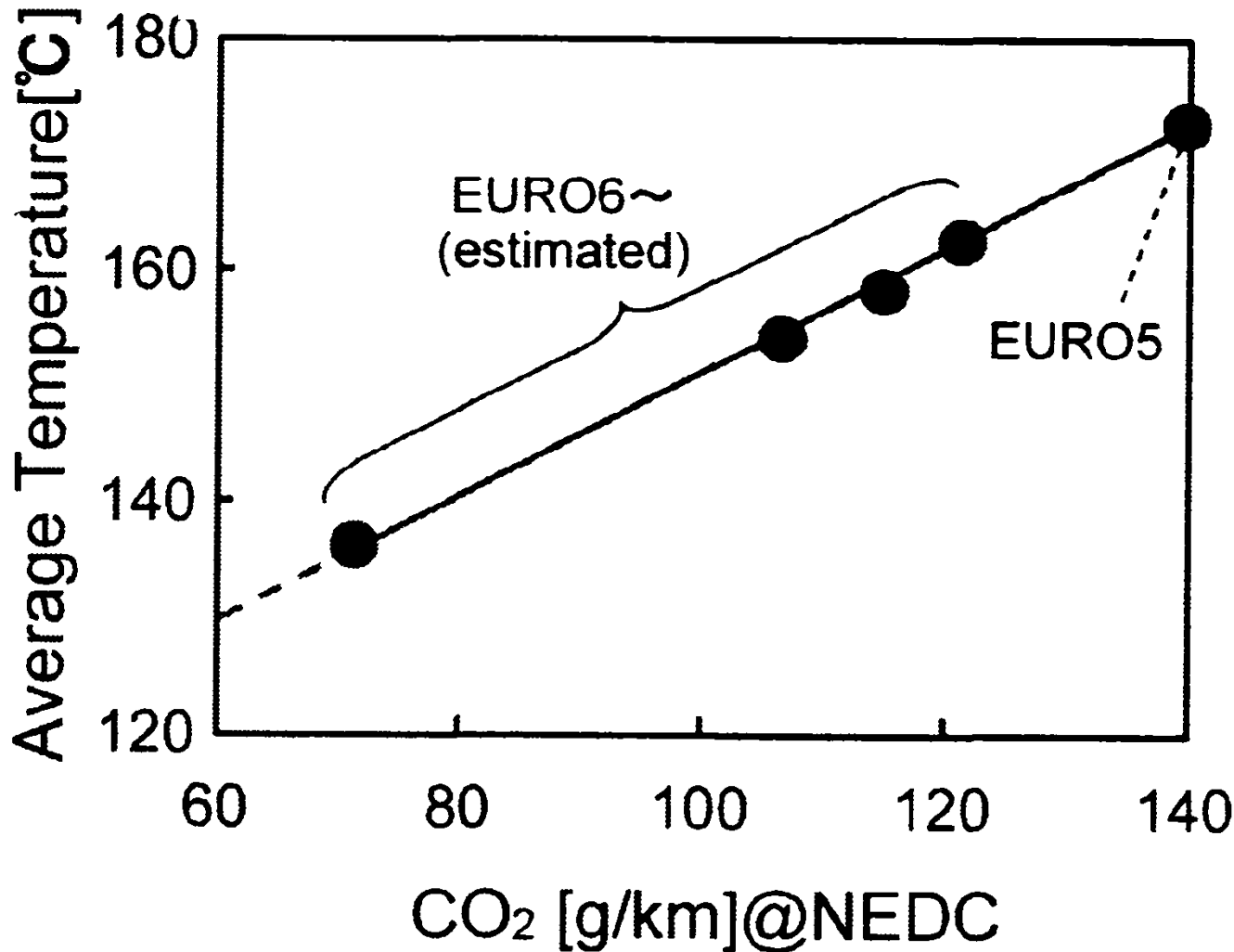

Future low CO₂ vehicles will have lower exhaust temperatures due to more TC and associated leaner diesel engine operation.

deNO_x catalyst for lean burn require $T > 200^{\circ}\text{C}$ for light off. RD temperatures are lower than on test cycles and so NO_x emissions will be higher.

Tsukamoto, Y. et al., Development of new concept catalyst for low CO₂ emissions Diesel engine using NO_x adsorption at low temperatures. Toyota.

SAE 2012-01-0370

Prediction of Urban Air Quality in Europe -1

There are relatively few experimentally based air quality measurements in Europe and in UK cities. One per city is quite common.

In Leeds the entire Leeds air quality is measured by the official government funded site at ONE location in the centre of Leeds. This is about 20m from a busy slip road leading to the Leeds Inner Ring Road. Concentrations elsewhere are based on the Leeds air quality model.

The city council has additional roadside measurement locations and one of these is in Headingley on the A660, on the congested route used in this study. This is a site that frequently exceeds European regulations on NOx and PM and this study investigates the pollution from traffic passing this site using a probe vehicle in the traffic flow with PEMS.

Predictions of air quality relating to traffic rely on three inputs:

- 1. Traffic modelling for traffic flows and mean travel time.**
- 2. The UK national database for the age of registered vehicles in Leeds**
- 3. The certified emissions per vehicle according to its age – using the NEDC test cycle.**
- 4. Although there is a procedure agreed in the UK to take into account cold start in situations where they may be significant, this is often ignored for Euro 3 onwards and was ignored in the Leeds model.**

Leeds NGT Trolleybus Public Inquiry TWAO Doc. A-08c-1 Air Quality, Sept. 2013

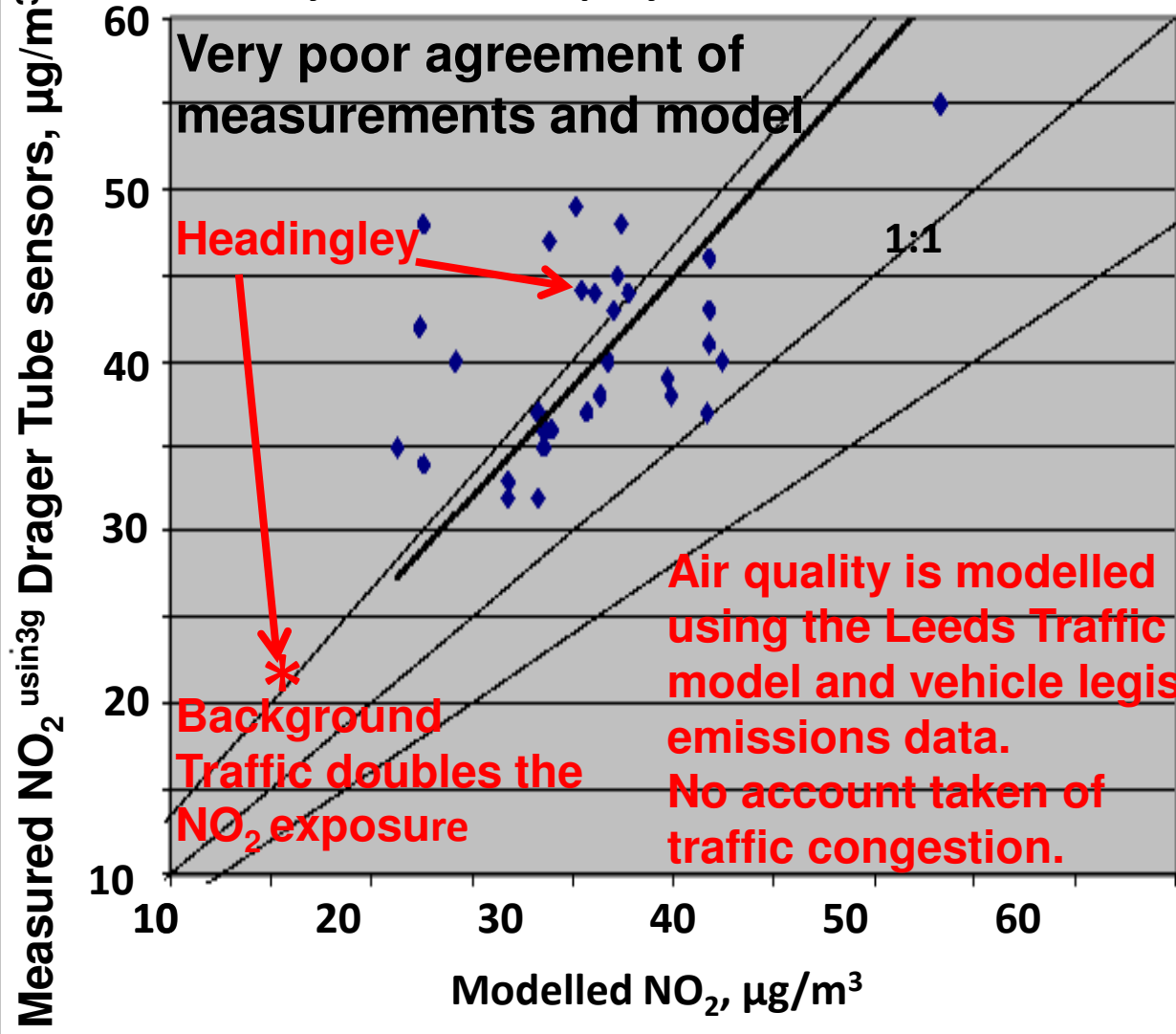

Very poor agreement of measurements and model

Headingley

Background Traffic doubles the NO₂ exposure

Air quality is modelled using the Leeds Traffic model and vehicle legislated emissions data. No account taken of traffic congestion.

Regulations for NO₂ are 40 µg/m³ annual limit. 100µg/m³ one hour limit.

- ◆ Actual data
 - 1:1 agreement
 - - - +/- 25%
 - Best linear fit
- $y = 1.281x$

On average the Leeds air quality model is 28% too low in its prediction of NO₂ at the monitored sites across Leeds.

Leeds NGT Trolleybus Public Inquiry TWAO Doc. A-08c-1 Air Quality, Sept. 2013

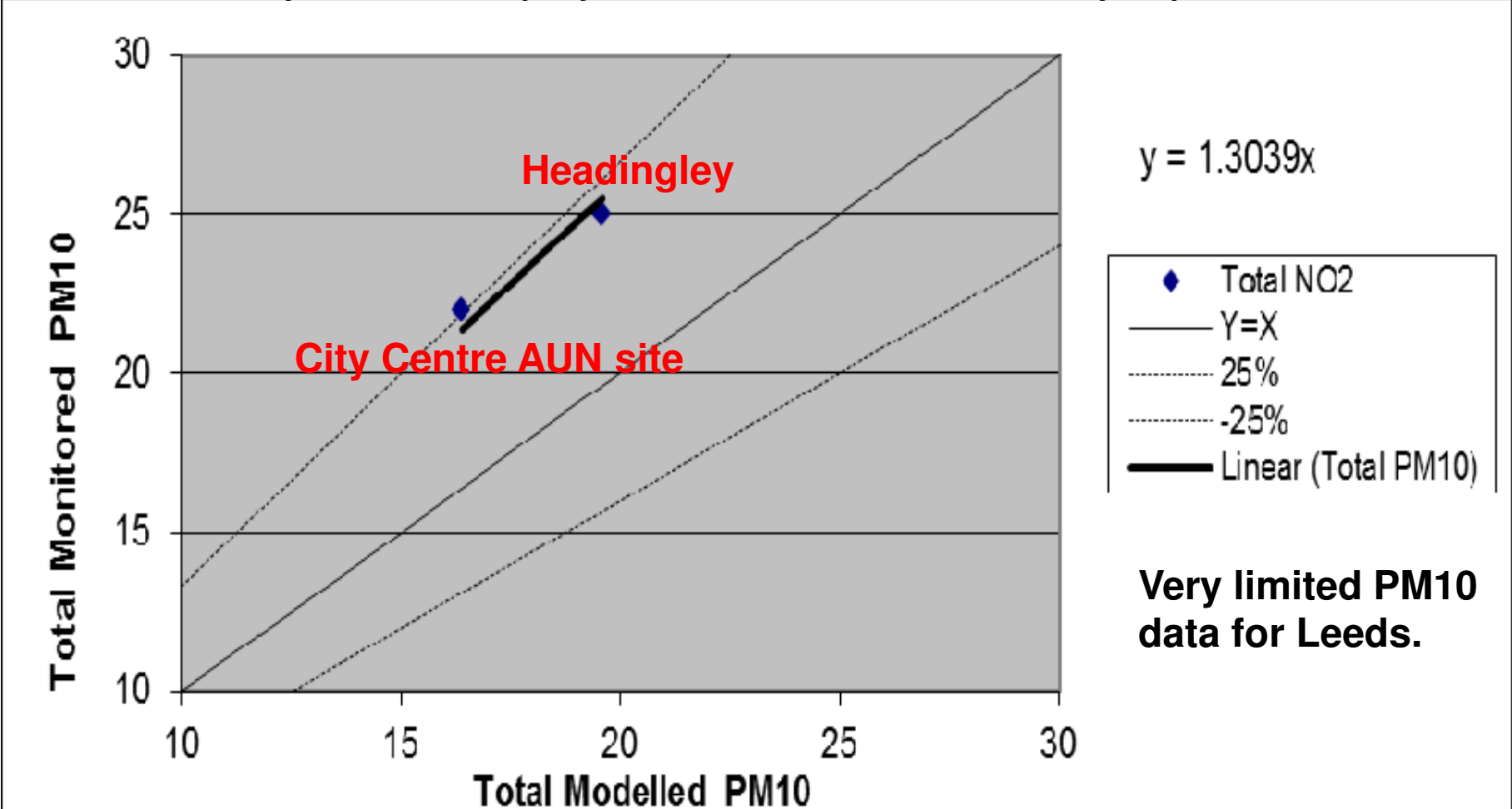

Very poor agreement between air quality modelling and measurements for PM10. This is because the model used PM for traffic from the legislated test cycles and emissions in congested traffic are higher.

Tim Johnson, Review of Vehicular Emissions Trends, SAE Int. J. Engines 7(3) 2015, Corning Inc. doi:10.4271/2015-01-0993 SAE Paper 2015-01-0993

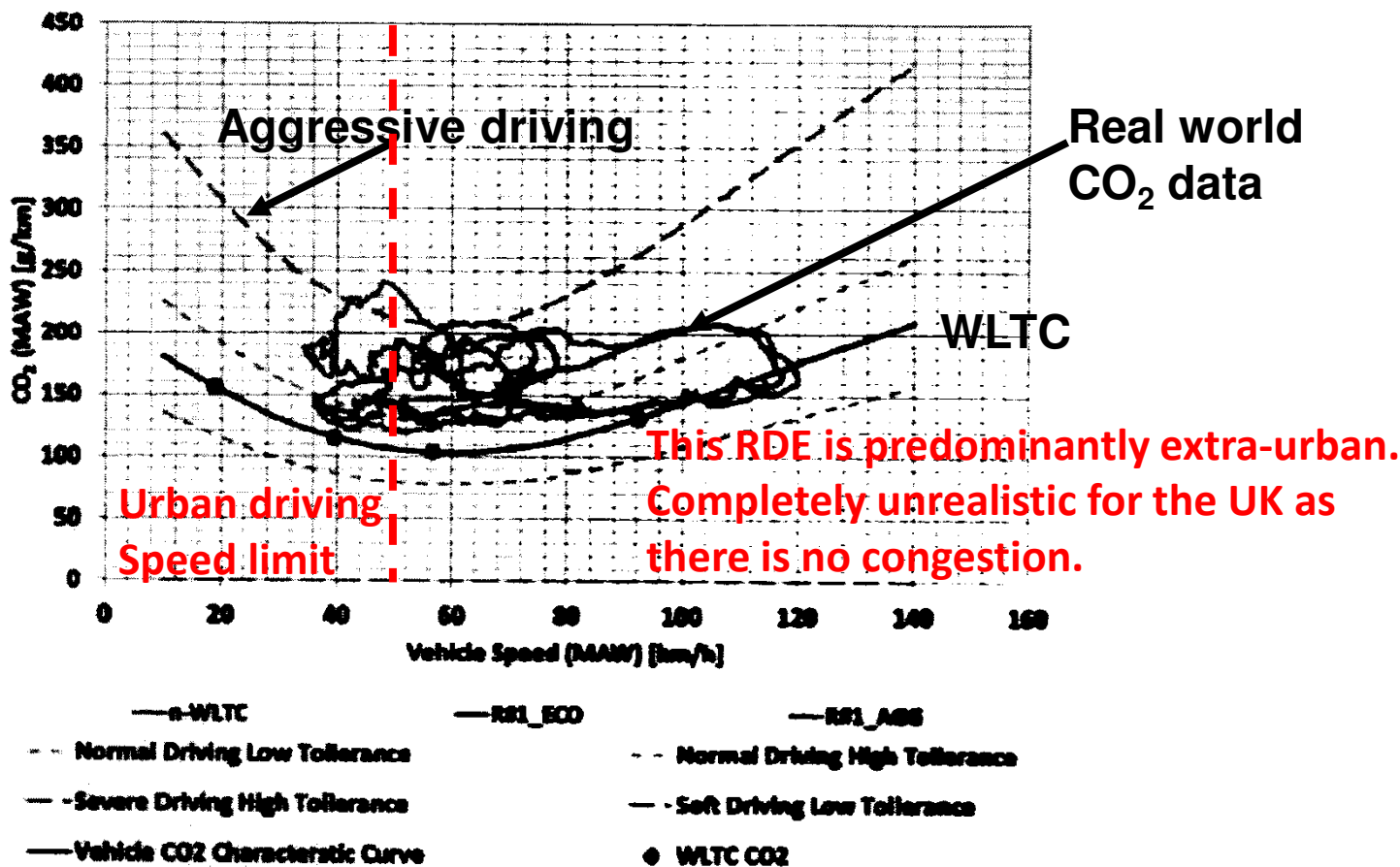

8. Vlachos, T. et al. In use emissions testing with PEMS in the current and future European vehicle Emissions legislation: Overview underlying Principles and expected benefits. SAE Int. J. Commer. Veh. 7(1):199-215 Doi:10.427/2014-01-1549. SAE Paper 2014-01-1549

Figure 1. Representation of the Moving Average Window (MAW) approach to determining applicability of PEMS data from in-use emissions. Solid lines represent test data. Dashed lines represent two levels of tolerance or acceptability of the data. (8)

Comparison of congestion simulated in test cycles

This assumes a regulated speed of 30 mph or 48.3kph for urban driving

Test Cycle	NEDC	FTP	CAFE	JC09	WLTC	RDE	This work
Mean Vel. kph	33.6	31.5	52.3	24.4	46.5	30 - 110 ¹	5 – 26
Congestion	30%	34%	0%	49%	3%	0%	90% - 46%
Max. Acc. m/s ²	1.0	1.5		1.7	1.7	1.5 ²	2.2 – 2.8
Distance, km	11	12		8.2	23.3	~80-90 ¹	5
No. Acc. From Idle / km	1.3	1.5		1.5	0.4	~0.2 ¹	1.2 - 7

RDE in congested traffic involves lower speeds, higher accelerations and many more accelerations from idle than on any legislated test cycle
WLTC will have lower emissions than NEDC due to higher speeds and proposals for RDE ignore congested driving completely

¹RDE Examples from S. Hausberger et al. TU Graz, 3rd Conf. RDE, Berlin, Oct. 2015.

²J. Merks et al. U. Poznaz, 3rd RDE, Berlin, Oct. 2015

The air quality exceedances for PM and NO₂ in cities is based on local monitoring stations close to roads with congested traffic e.g. Marylebone Road in London and Headingley in Leeds. **It is the local congested traffic that is the problem and as I have shown, none of the test cycles or so called improved test cycles address this issue and it is totally ignored in the proposals for RDE testing.**

In congested traffic the average speed is low, peak accelerations are high and the number of accelerations from idle/km is much higher than on any test cycle. These are the reasons for real world driving causing poor air quality in cities and these conditions are ignored in WLTC and RDE proposals. **Thus these new test procedures will not address the issue of real world driving and poor urban air quality.**

Contents

1. Air quality issues and Real Driving Emissions (RDE) in urban areas of cities
2. **Factors that influence RDE**
3. Experimental equipment
4. HDD truck RDE test for Euro V with SRC

Factors that influence RDE – both SI and Diesel

1. Driver behaviour – aggressive drivers – high acc./decel
2. Ambient temperature – affects catalyst light off and water and lube oil warm-up times, related to cold start.
3. **Congested traffic in urban driving – low average speed and more stop/starts – influence of other drivers – this is the main topic of this presentation.**
4. Traffic lights and road junctions – most emissions in urban areas occur at these real driving events.
5. **Cold start in RDE is longer than on test cycles and often occurs in congested traffic.**
6. Diesels have an additional problem that the catalyst can cool down after it has lit off – cruise and reaching congested traffic after a period of high speed driving. This will be shown for SCR and has previously been shown for oxidation catalysts.

Example of emissions mapping using Horiba OBS g/s in a Ford Mondeo Euro 1
For Euro II – VI with lower emissions there are no significant emissions other than at junctions, so the effect of junctions is greater.

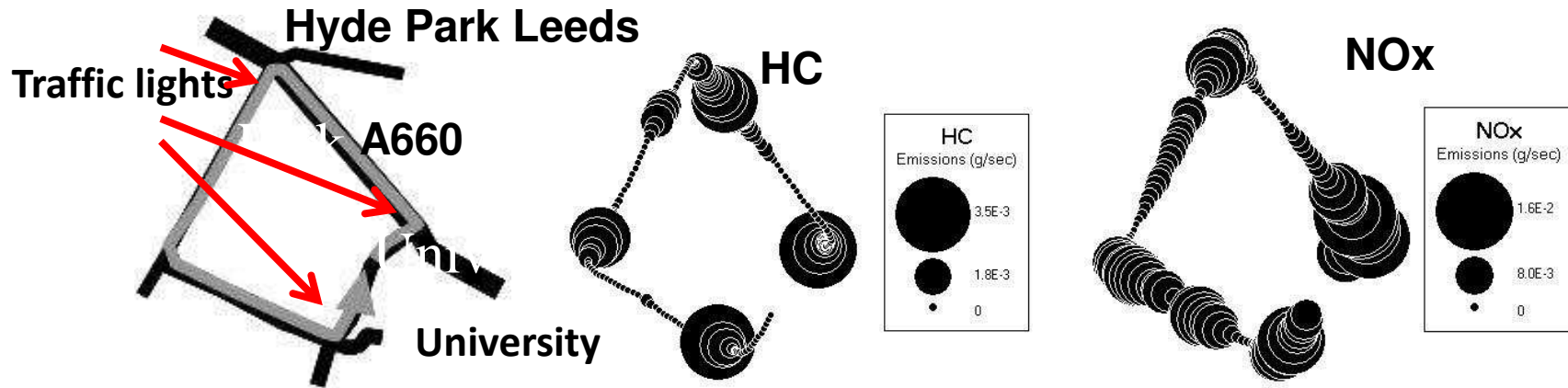

Pollution and CO₂ is predominantly at junctions for Euro 2 and increasingly so for Euro 4+

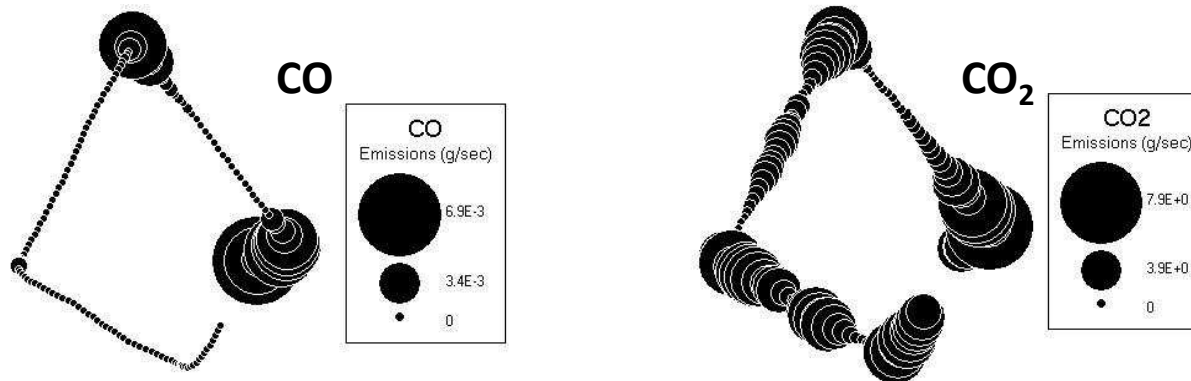

Junctions are the most important influence of congested traffic driving in urban locations. There are no junctions in the NEDC!

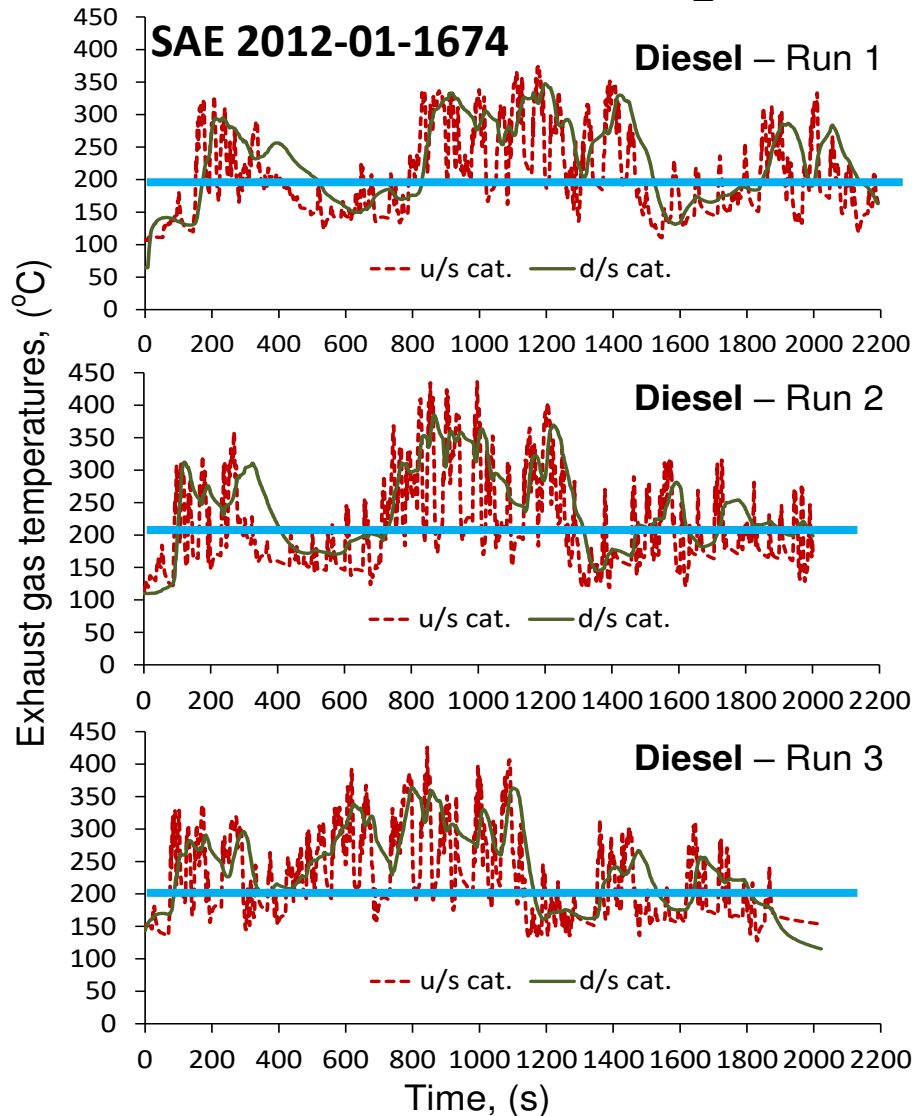

The present work was not designed to include a cold start, the time at the start of the test while instruments and data loggers were set up was sufficiently long for catalyst cooling to occur.

The low oxidation catalyst temperatures at the start of the test resulted in high CO and HC emissions during the subsequent warm up period.

For most of the journeys the catalyst temperature was well above 200°C.

However, there were times when the catalyst cooled down to around 150°C in congested traffic, where CO and HC increased.

This is a different catalyst behavior to that in SI vehicles operating at $\lambda=1$ as the exhaust temperatures are higher and there is greater heat release at the catalyst due to CO and HC oxidation.

Contents

1. Air quality issues and Real Driving Emissions (RDE) in urban areas of cities
2. Factors that influence RDE
3. **Experimental equipment**
4. HDD truck RDE test for Euro V with SRC

PEMS – Temet FTIR (Gasmeter) with Horiba OBS pitot tube exhaust mass flow measurements and gas sampling.

Racelogic GPS for velocity and acceleration measurements

Mercedes Benz AXOR-C6x2

Engine Mercedes-Benz OM457LA Euro V

Euro 5 with SCR deNOx

Unit injectors, TCIC, 4v/cyl.

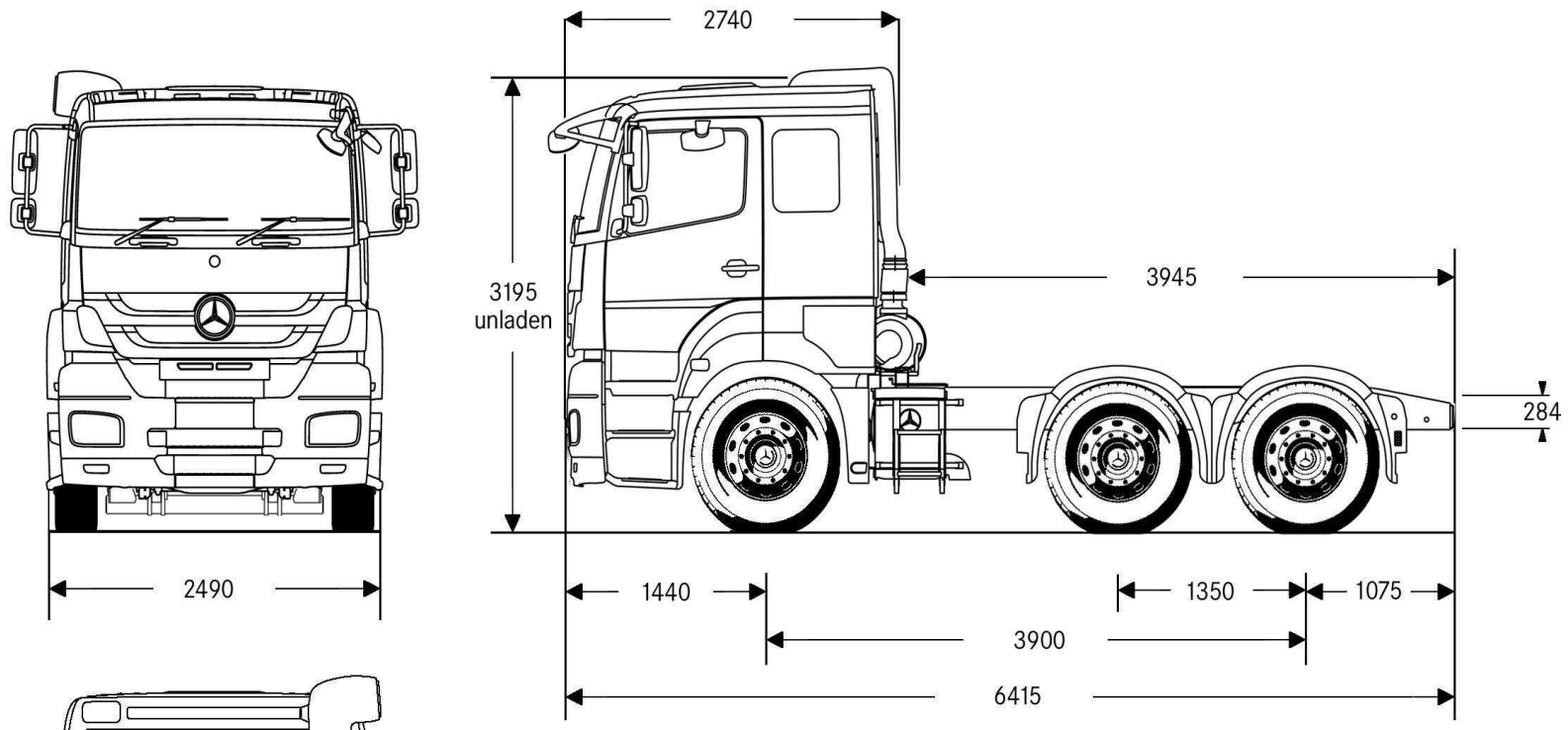

Mercedes Benz AXOR-C6x2

Engine Mercedes-Benz OM457LA Euro V

Euro 5 with SCR deNOx

Unit injectors, TCIC, 4v/cyl.

Note that Euro V HDD did not have any cold start requirements to meet. The RDE are dominated by cold start issues

Contents

1. Air quality issues and Real Driving Emissions (RDE) in urban areas of cities
2. Factors that influence RDE
3. **HDD truck RDE test for Euro V with SRC**
4. Experimental equipment
5. Congested traffic route – Headingley, Leeds
6. Number of starts from idle
7. Typical emissions records for one journey
8. Average journey emissions v. mean velocity
9. Most congested section of the journey
10. Individual acceleration events v. mean vel. In acc.
11. Individual constant velocity (cruise) sections of the journey
12. Conclusions

Gordon E. Andrews, Hu Li, Ali S. Hadavi, Ahmad Khalfan
School of Chemical and Process Engineering, University of Leeds, UK
RDE in Congested Traffic with Cold Start

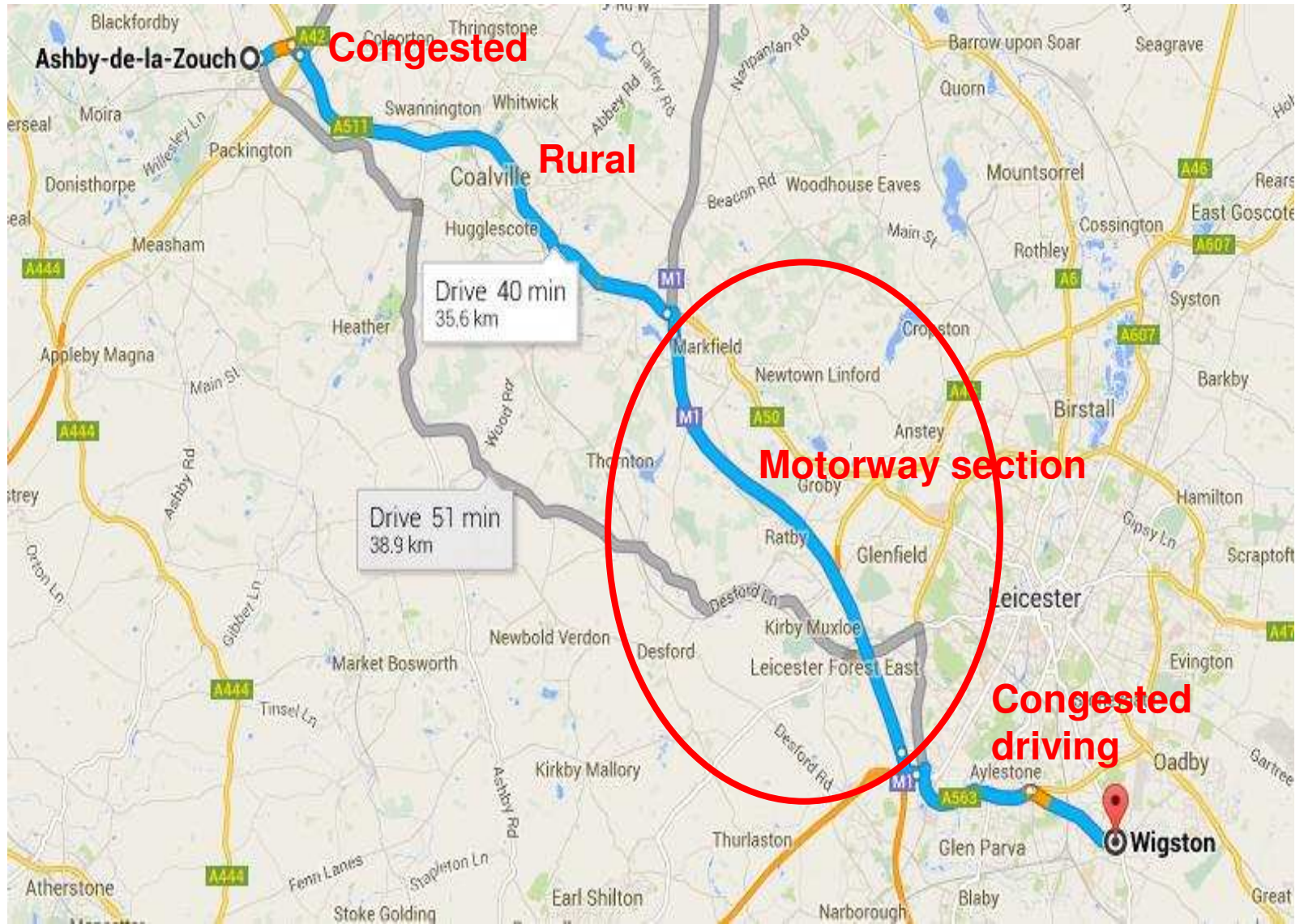

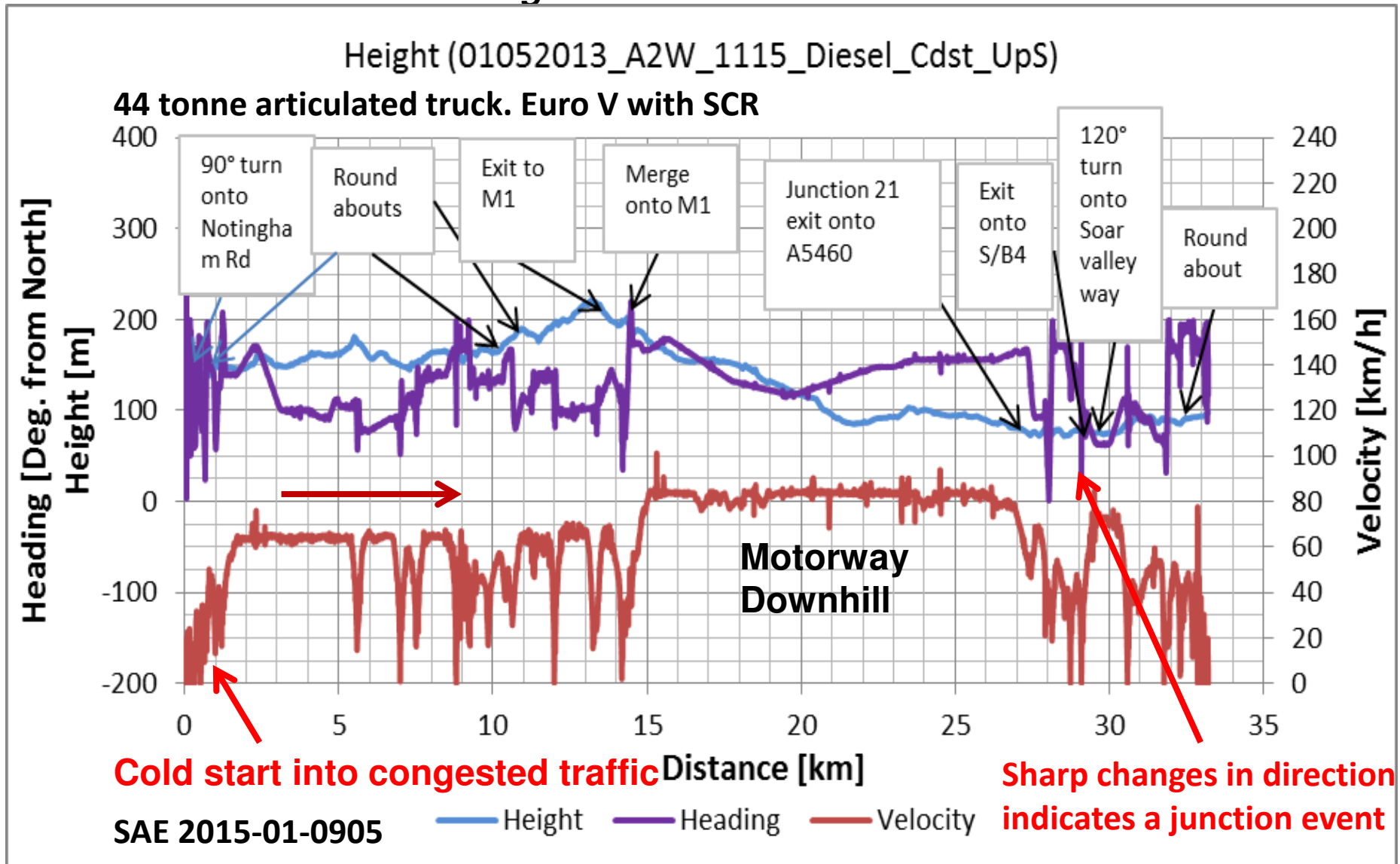

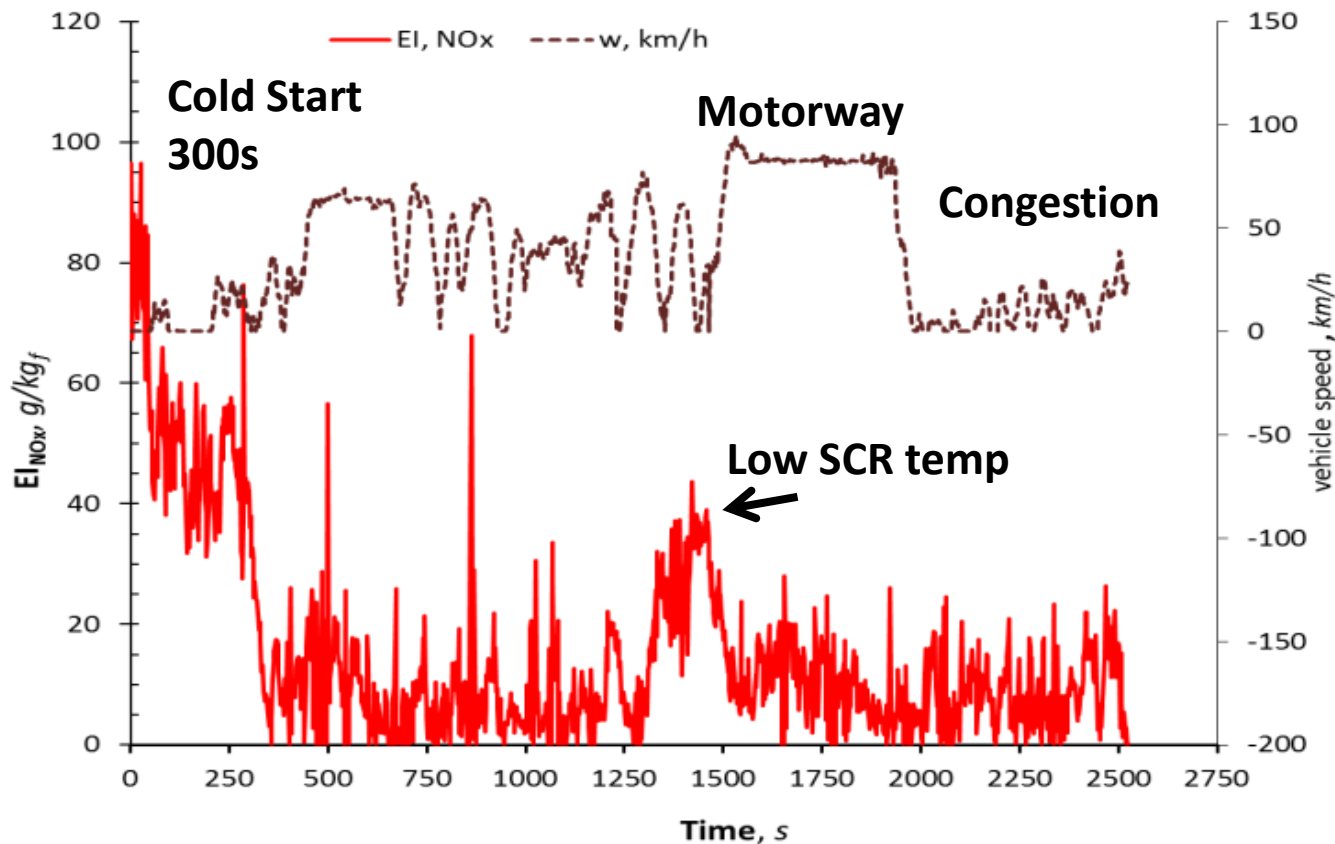

In these RDE tests cold start occurs into congested traffic and SCR light off is very long due to low exhaust temperatures.

This is the NOx mass emission in g_{NOx}/kg_{fue}

Clearly the deNOx efficiency is poor on this journey and the cold start effect is very clear over the first 300s. The spikes are likely to be due to inadequate Urea control and the rise in the mean NOx to inadequate catalyst temperature.

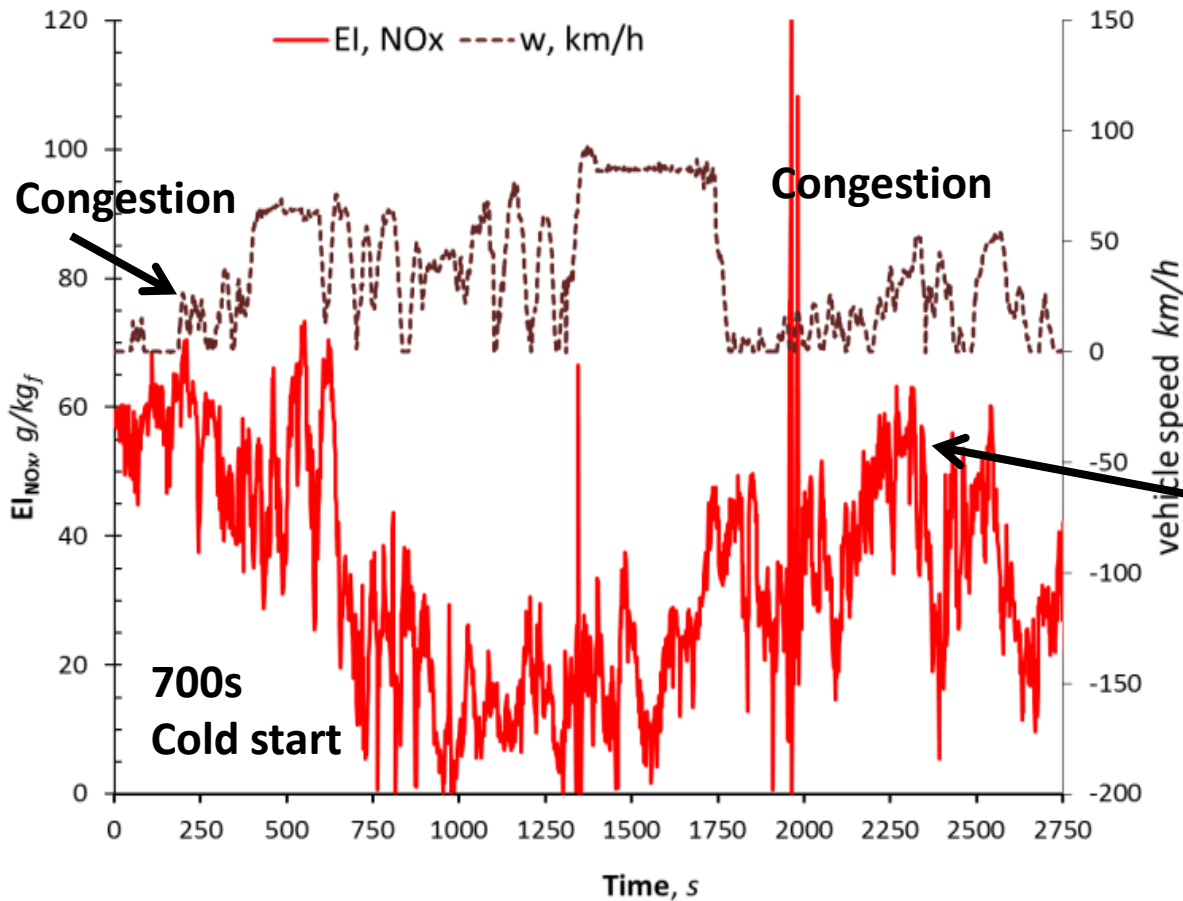

Very poor SCR efficiency in congested traffic for cold start AND prior hot catalyst.

Poor SCR catalyst efficiency due to low cat. temps. in the congested traffic.

Several NOx mass emissions for different trips on the same journey are shown in this and the next slide.

