



This is a repository copy of *Simulation of Waste Heat Recovery System with Fuzzy Based Evaporator Model*.

White Rose Research Online URL for this paper:

<https://eprints.whiterose.ac.uk/134144/>

Version: Accepted Version

Proceedings Paper:

Chowdhury, J.I., Soulatiantork, P. orcid.org/0000-0003-3212-8220 and Nguyen, B.K. (2018) Simulation of Waste Heat Recovery System with Fuzzy Based Evaporator Model. In: 2017 11th Asian Control Conference (ASCC). 2017 11th Asian Control Conference (ASCC), 17-20 Dec 2017, Gold Coast, Australia. IEEE , pp. 2143-2147. ISBN 978-1-5090-1573-3

<https://doi.org/10.1109/ASCC.2017.8287506>

Reuse

Items deposited in White Rose Research Online are protected by copyright, with all rights reserved unless indicated otherwise. They may be downloaded and/or printed for private study, or other acts as permitted by national copyright laws. The publisher or other rights holders may allow further reproduction and re-use of the full text version. This is indicated by the licence information on the White Rose Research Online record for the item.

Takedown

If you consider content in White Rose Research Online to be in breach of UK law, please notify us by emailing eprints@whiterose.ac.uk including the URL of the record and the reason for the withdrawal request.



eprints@whiterose.ac.uk
<https://eprints.whiterose.ac.uk/>

Simulation of Waste Heat Recovery System with Fuzzy Based Evaporator Model

J. I. Chowdhury, P. Soulatiantork, B. K. Nguyen, *Member, IEEE*

Abstract— The organic Rankine cycle (ORC) is one of the promising waste heat recovery (WHR) technologies used to improve the thermal efficiency, reduce the emissions and save the fuel costs of internal combustion engines. In the ORC-WHR system, the evaporator is considered to be the most critical component as the heat transfer of this device influences the efficiency of the system. Although the conventional Finite Volume (FV) model can successfully capture the complex heat transfer process in the evaporator, the computation time for this model is high as it consists of many iterative loops. To reduce the computation time, a new evaporator model using the fuzzy inference technique is developed in this research. The developed fuzzy based model can predict the evaporator outputs with an accuracy of over 90% while it reduces the simulation time significantly. This model is then integrated with other components of the ORC to simulate a completed ORC-WHR system for internal combustion engines. The influence of operating parameters on the performance of the WHR system is investigated in this paper.

I. INTRODUCTION

Most of the energy produced by internal combustion engines is expelled to the environment via the exhaust and coolant systems. The expelled energy makes the engine running cost high and is one of the major causes of global warming and environmental pollution. In order to reduce fuel consumption, waste heat recovery (WHR) has been used to collect the heat from the exhaust or coolant and convert it into either mechanical or electrical power, which increases the thermal efficiency of the engine (1).

The ORC WHR system consists of four major components: pump, evaporator, expander and condenser, as shown in Figure 1. Liquid refrigerant is pumped to the evaporator where it is heated and vaporized by the heat sources. This vaporized fluid is then expanded and produces mechanical energy output through the shaft of the expander. A generator is normally coupled with the expander shaft to convert mechanical energy into electrical power. Exhaust products from the expander pass through the condenser where secondary cooling fluid removes extra heat and converts the exhaust back to a liquid.

The operating conditions of the ORC have a significant influence on the thermal efficiency and heat utilization of the WHR system. Two classified operating conditions of the ORC waste heat recovery system can be observed: subcritical and supercritical. The operating pressure of the subcritical ORC is below the critical pressure of the working fluid; while the supercritical ORC is run at a pressure higher than the critical pressure.

Modelling of the evaporator in the ORC WHR system has been addressed in several reports (2, 3). Despite high accuracy and robustness (4), the finite volume modelling

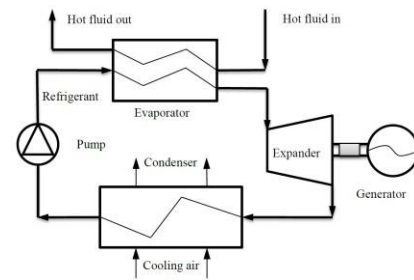

Figure 1. Components of a typical Organic Rankine Cycle (ORC) WHR system

technique is a highly time consuming method since it consists of many iterative loops (5, 6), therefore, it has a limitation in real time control applications. In order to reduce the computation time of the evaporator model, a new evaporator model using the fuzzy inference technique is introduced and described in this paper. The developed fuzzy based evaporator model is then integrated and simulated with models of other components in the WHR system to investigate the effect of operating parameters on the performance of the WHR system.

II. FUZZY BASED EVAPORATOR MODEL

Among the conventional heat exchangers available in the market, a plate heat exchanger has a large heat transfer area along with high compactness which is suitable to recover a maximum amount of heat from the heat sources (5). This type of heat exchanger is therefore used as the evaporator for the simulation in this research. The geometrical dimensions and parameters of the selected evaporator are listed in Table 1.

TABLE I SPECIFICATIONS OF THE EVAPORATOR (7)

Symbol	Parameter	Value
A	Heat transfer area of the evaporator	5.78 m ²
L	Length of the plate	0.478 m
W	Width of the plate	0.124 m
N _p	Number of plates	100
K	Thermal conductivity	15 W/m K

J. I. Chowdhury is now with the Cranfield University, Cranfield, MK43 0AL, UK (email: j.chowdhury@cranfield.ac.uk).

P. Soulatiantork is with the Queen's University Belfast, Belfast BT9 5AH, UK (email: p.soulatiantork@qub.ac.uk).

The fuzzy technique introduced by Mamdani & Assilian (8) is used to develop the evaporator model in this research. The proposed fuzzy-based evaporator model consists of three inputs and two outputs and is shown in Fig. 2. The mass flow rate of refrigerant \dot{m}_r , the mass flow rate of hot fluid \dot{m}_h and the temperature of hot fluid T_h are considered as the inputs of the model; whereas the evaporator heat input Q_{ev} and the

B. K. Nguyen is with the University of Sussex, Brighton, BN1 9QT, UK (phone: +44 (0)12-7387-2869; email: b.k.nguyen@sussex.ac.uk).

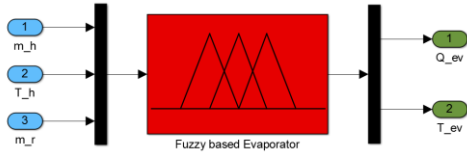

Figure 2. Fuzzy inference system for evaporator

evaporator outlet temperature T_{ev} are considered to be the outputs of the model. The fuzzy-based evaporator model represents the nonlinearity of the system by a logical mapping of its input variables to the output variables. The fuzzy logic is used to predict an unknown output of a system by establishing the degree of matching among the known inputs and outputs relationships. The development steps of the fuzzy-based evaporator model can be described as follows:

Step 1: Variables identification

The minimum and maximum values of the inputs and outputs variables of the fuzzy model are as follows: $[\bar{m}_{r\min}, \bar{m}_{r\max}] = [28.6 \text{ (gm/s)}, 255 \text{ (gm/s)}]$, $[\bar{m}_{h\min}, \bar{m}_{h\max}] = [50 \text{ (gm/s)}, 300 \text{ (gm/s)}]$, $[T_{h\min}, T_{h\max}] = [403 \text{ (K)}, 525 \text{ (K)}]$, $[Q_{ev\min}, Q_{ev\max}] = [-11 \text{ (kW)}, 80 \text{ (kW)}]$ and $[T_{ev\min}, T_{ev\max}] = [336 \text{ (K)}, 517 \text{ (K)}]$, respectively. These ranges were identified from the inputs and outputs of the WHR system and adjusted from the knowledge and experience of the system and were normalized over the

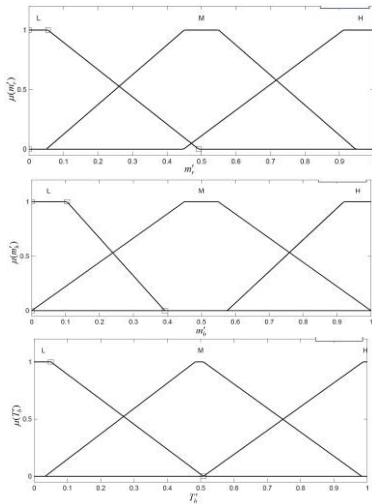

Figure 3. Membership functions of input variables.

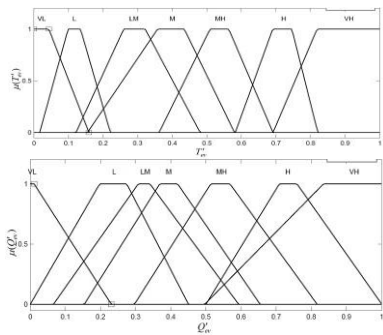

Figure 4. Membership functions of output variables

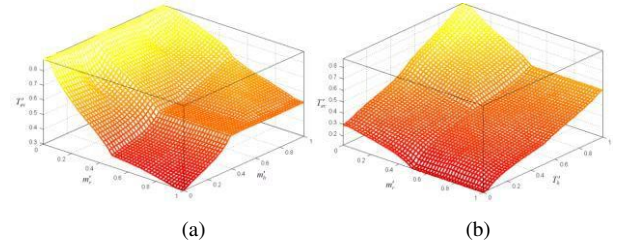

Figure 5. Fuzzy surface of the evaporator outlet temperature with respect to \bar{m}_r and \bar{m}_h (a), and with respect to \bar{m}_r and T_h (b)

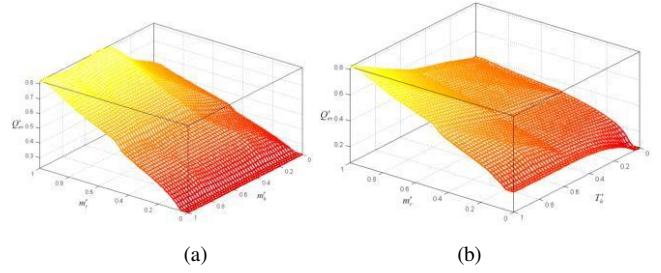

Figure 6. Fuzzy surface for the evaporator power with respect to \bar{m}_r and \bar{m}_h (a), and with respect to \bar{m}_r and T_h (b)

interval $[0, 1]$, as shown in Figs. 3-4. The actual crisp values of the model parameters are calculated from the normalised values as follows: $\bar{m}_r = 28.6 + 226.4 \bar{m}_r'$; $\bar{m}_h = 50 + 250 \bar{m}_h'$; $T_h = 403 + 122T_h'$; $T_{ev} = 336 + 181T_{ev}'$; $Q_{ev} = -11 + 91Q_{ev}'$ where \bar{m}_r' , \bar{m}_h' , T_h' , T_{ev}' and Q_{ev}' are the normalised values of their corresponding variables.

Step 2: Fuzzification

The variables ranges identified in step 1 are divided into several linguistic levels. The linguistic levels assigned to the input and output variables of the model are as follows: VL: Very Low; L: Low; LM: Low to Medium; M: Medium; MH: Medium to High; H: High and VH: Very High. The input and output membership functions are shown in Figs. 3 and 4.

Step 3: Fuzzy rules and fuzzy reasoning

The fuzzy rules of the evaporator model are created using the above fuzzy sets of the input and output variables and can be presented as follows:

Rule i : IF \bar{m}_r is α_i AND \bar{m}_h is β_i AND T_h is γ_i THEN T_{ev} is δ_i AND Q_{ev} is ψ_i (1)

where $i = 1, 2, 3, \dots, n$, n is the number of fuzzy rules, α_i , β_i , γ_i , δ_i , ψ_i are the i th fuzzy sets of the input and output variables of the fuzzy system.

The fuzzy rules used in this model are shown in Figs. 5-6.

Step 4: Defuzzification

The centroid defuzzification method (9) is used in this paper to convert the aggregated fuzzy set to a crisp output value Y from the fuzzy set Φ' in $V \subset R$. The crisp output from the aggregated fuzzy set is computed as follows:

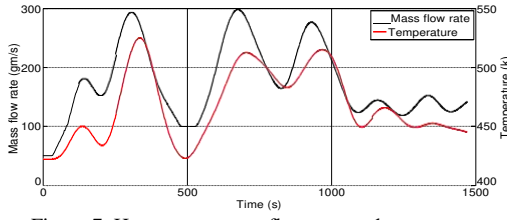

Figure 7. Heat source mass flow rate and temperature

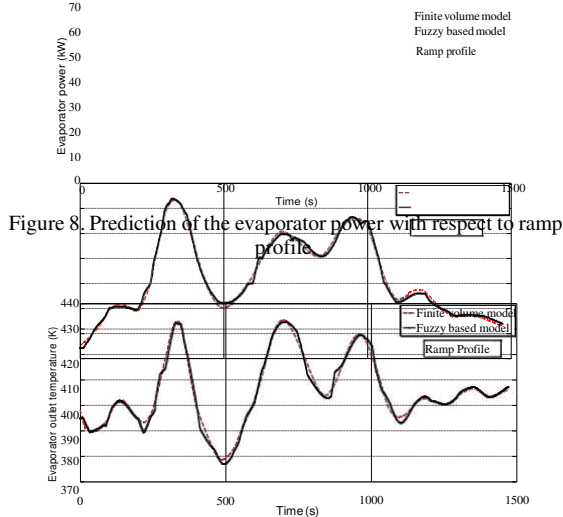

Figure 8. Prediction of the evaporator power with respect to ramp profile

Figure 9. Prediction of the evaporator outlet temperature with respect to ramp profile.

$$Y = \frac{\int_V \mu_{\Phi'}(y) \cdot y dy}{\int_V \mu_{\Phi'}(y) dy} \quad (2)$$

The crisp value of Q_{ev} and T_{ev} were calculated using the above expression.

To predict the fuzzy model outputs, the evaporator is simulated with the heat source shown in Fig. 7 and a random ramp profile of refrigerant flow rates. The fuzzy model outputs, Q_{ev} and T_{ev} , are compared with the conventional FV method (7) and presented in Figs. 8-9. The RMSE and congruency of fit between the fuzzy model and the FV model for the Q_{ev} are 0.95 kW and 93.68%, and for T_{ev} are 1.48 K and 89.16%, respectively. Results show that the developed fuzzy model can be used to estimate the evaporator outputs accurately. The time used for the simulation of the random heat source in the fuzzy-based model is 5.19 s, compared to 3820.6 s of the FV model.

III. OVERALL MODEL OF WHR SYSTEM

The overall model of the cycle shown in Fig. 10 is built by interconnecting all subcomponents in the WHR system. The inputs and outputs of the adjacent components are as follows:

TABLE 2 OVERALL MODEL PARAMETERS

Input variables	Output variables
$N_p, P_{p,i}, P_{p,o}, m_h, T_h$	$Q_{ev}, T_{ev}, W_p, W_{exp}, Q_c$

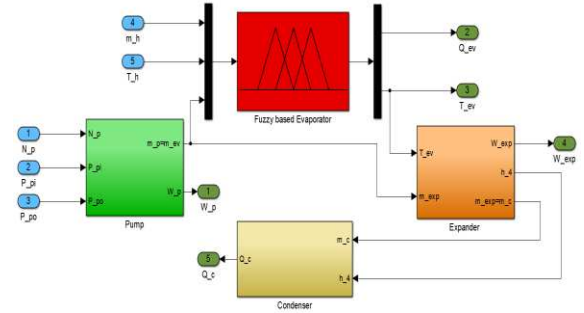

Figure 10. Overall model of the ORC-WHR system.

- The mass flow rates of the pump and through all other components are assumed to be equal, $\bar{m}_p = \bar{m}_{r,i} = \bar{m}_{exp} = \bar{m}_c$.
- Pressure at the pump outlet is equal to the pressure of the evaporator and at the expander inlet, such that $P_{p,o} = P_{ev,i} = P_{ev,o} = P_{exp,i}$.
- Pressure at the expander outlet and in the condenser is equal to the pressure at the pump inlet, such that $P_{exp,o} = P_c = P_{p,i}$.
- The enthalpy at the pump outlet and at the evaporator inlet are equal, $H_{p,o} = H_{r,i}$.
- Enthalpy and specific volume of the refrigerant at the pump inlet is a function of inlet pressure, $H_{p,i}, v_p = f(P_{p,i})$ and the temperature of the refrigerant at the inlet of the evaporator is a function of the enthalpy and pressure at the pump outlet, $T_{r,i} = f(P_{p,o}, H_{p,o})$.

By interconnecting the individual inputs and outputs of each component, a set of overall model inputs-outputs can be defined and listed in Table 2.

IV. SIMULATION RESULTS

A generic heat source in terms of variable mass flow rate and temperature (Fig. 7) defined by Quoilin et al. (10) is used for the investigation of the waste heat recovery system at supercritical condition. The working fluid of the ORC used in this simulation is R134a, which is widely used for commercial purposes, readily available and has a high auto-ignition temperature. To investigate the effect of operating parameters on the system output, a random pump speed profile ranging from 200RPM to 1750RPM, and its corresponding mass flow rate (Fig. 11) is used in the simulation. The range of the mass flow rate profile of the selected pump is from 28.8 gm/s to 249.5 gm/s. The pump outlet pressure is set to 6 MPa. This value is well above the critical pressure of the R134a refrigerant which is 4.06 MPa.

The outputs of the fuzzy based evaporator are shown in Figs. 12-13. In Fig. 12, it shows that the minimum and maximum heat absorbed by the evaporator is 4.17 kW and 61.8 kW, respectively. Fig. 13 shows the evaporator outlet temperature under the variable heat source and random refrigerant flow rates at the evaporator. The evaporator temperatures in this simulation are varied from 379 K to 448 K.

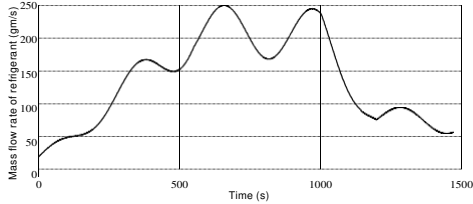

Figure 11. Mass flow rate of refrigerant

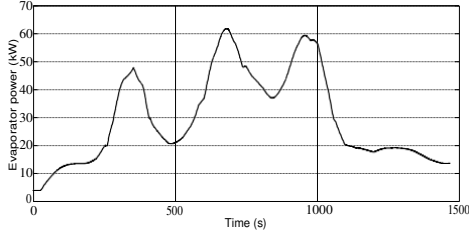

Figure 12. Evaporator heat input

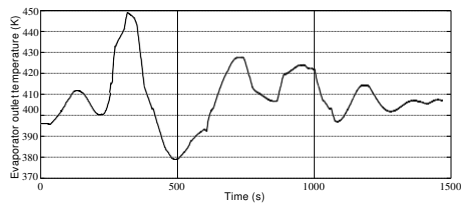

Figure 13. Evaporator outlet temperature

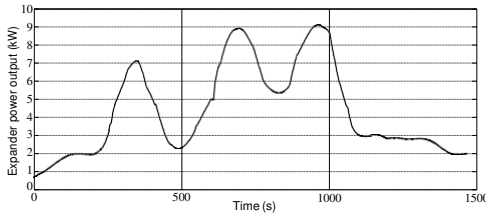

Figure 14. Expander power output.

The expander power output is shown in Fig. 14. In this simulation, the maximum power output of around 9 kW is observed.

The performance of the ORC-WHR system is calculated by two basic parameters: cycle efficiency and heat recovery efficiency as follows:

$$\eta_{cy} = \frac{W_{Net}}{Q_{ev}} \quad (3)$$

$$\eta_{hr} = \frac{Q_{ev}}{Q_h} \quad (4)$$

where η_{cy} is the cycle efficiency, which is the ratio of net work output to the heat recovered at the evaporator, η_{hr} is the heat recovery efficiency which is defined as the amount of heat recovered from the given heat source. Q_{ev} is the evaporator power which is one of the outputs of the fuzzybased evaporator model.

The net work output W_{net} in Eq. 5 is calculated by subtracting the pump work W_p from the expander gross work as follows.

$$W_{net} = (W_{exp} - W_p) \quad (5)$$

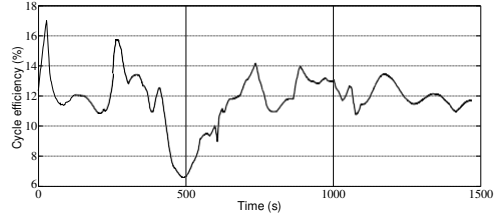

Figure 15. ORC cycle efficiency

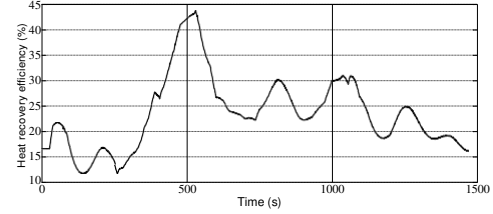

Figure 16. Heat recovery efficiency

The heat power Q_h in Eq. 6 is the total available heat capacity of the heat source which is calculated by

$$Q_h = \dot{m}_h (H_{h,i} - H_{h,ref}) \quad (6)$$

where $H_{h,i}$ and $H_{h,ref}$ are the heat source enthalpies at the inlet of the evaporator and at the reference temperature of 303 K, respectively.

The cycle efficiency of the ORC depends on several factors including the temperature of the evaporator, heat of vapourisation, pressure ratio at the expander, etc. Fig. 15 shows the cycle efficiency of the ORC-WHR model for the selected heat source. The cycle efficiency varies from around 6.6% to around 17%, depending on the combination of the mass flow rate and temperature of the hot fluid and refrigerant. The WHR system in this simulation is able to recover up to 44% (Fig. 16) of the heat from the specified heat source as shown in Fig. 8. It can be seen from Figs. 15 and 16 that the trends of the cycle and heat recovery efficiency are opposite to each other.

V. CONCLUSIONS

In this research, the development of the fuzzy based evaporator model and its integration with other components in the ORC-WHR system have been presented. The performance of the fuzzy base evaporator model and the WHR system including cycle and heat recovery efficiency has also been investigated.

The fuzzy-based model proposed in this paper does not require complex mathematical formula and iteration loops; therefore, it can reduce the simulation time significantly. The investigation of the ORC based WHR model in this paper can provide an overall mapping and characterization of the output ranges of the waste heat recovery system with respect to different input ranges. The developed model is suitable to predict the effect of mass flow rate of the refrigerant on the evaporator outlet temperature, which is the critical parameter for the control of the WHR system in real time.

ACKNOWLEDGMENT

The authors gratefully acknowledge the Queen's University Belfast and the Engineering and Physical

Sciences Research Council (EPSRC) for their support in this research.

REFERENCES

- [1] Glover, S.; Douglas, R.; Glover, L.; McCullough, G. Preliminary analysis of Organic Rankine Cycles to improve vehicle efficiency. *Proc. IMechE D J. Automob. Eng.* 2014, 228, pp.1142–1153.
- [2] Quoilin, S.; Aumann, R.; Grill, A.; Schuster, A.; Lemort, V.; Spliethoff, H. Dynamic modeling and optimal control strategy of waste heat recovery Organic Rankine Cycles. *Appl. Energy* 2011, 88, pp. 2183–2190.
- [3] Feru, E.; Willems, F.; Jager, B.D.; Steinbuch, M. Modeling and control of a parallel waste heat recovery system for Euro-VI heavy-duty diesel engines. *Energies* 2014, 7, pp.6571–6592.
- [4] Karellasa, S.; Schuster, A.; Leontaritis, A.-D. Influence of supercritical ORC parameters on plate heat exchanger design. *Appl. Therm. Eng.* 2012, 33, pp. 70–76.
- [5] Sun, J.; Li, W. Operation optimization of an Organic Rankine Cycle (ORC) heat recovery power plant. *Appl. Therm. Eng.* 2011, 31, pp. 2032–2041.
- [6] Patiño, J.; Llopis, R.; Sánchez, D.; Sanz-Kock, C.; Cabello, R.; Torrella, E. A comparative analysis of a CO₂ evaporator model using experimental heat transfer correlations and a flow pattern map. *Int. J. Heat Mass Transfer* 2014, 71, pp. 361–375.
- [7] Chowdhury, J.I., Nguyen, B.K., Thornhill, D.: Modelling of Evaporator in Waste Heat Recovery System using Finite Volume Method and Fuzzy Technique, *Energies*, 2015, 8, (12), pp. 14078-14097.
- [8] Mamdani, E.H., Assilian, S.: An experiment in linguistic synthesis with a fuzzy logic controller, *International Journal of Man-Machine Studies*, 1975, 7, (1), pp. 1-13.
- [9] Ross, T.J.: *Fuzzy logic with engineering applications* (John Wiley, Chichester, U.K., 3 2010).
- [10] Quoilin, S., Aumann, R., Grill, A., Schuster, A., Lemort V., Spliethoff H.: Dynamic modeling and optimal control strategy of waste heat recovery Organic Rankine Cycles, *Applied Energy*, 2011, 88, pp. 2183-2190.