



This is a repository copy of *Sequential supplementary firing in combined cycle power plant with carbon capture: part-load operation scenarios in the context of EOR*.

White Rose Research Online URL for this paper:

<https://eprints.whiterose.ac.uk/133053/>

Version: Published Version

Proceedings Paper:

Gonzalez Diaz, A., Fernandez, E.S., Gibbins, J. orcid.org/0000-0003-0963-4555 et al. (1 more author) (2017) Sequential supplementary firing in combined cycle power plant with carbon capture: part-load operation scenarios in the context of EOR. In: 13th International Conference on Greenhouse Gas Control Technologies, GHGT-13. 13th International Conference on Greenhouse Gas Control Technologies, GHGT-13, 14-18 Nov 2016, Lausanne, Switzerland. Energy Procedia (114). Elsevier , pp. 1453-1468.

<https://doi.org/10.1016/j.egypro.2017.03.1901>

Reuse

This article is distributed under the terms of the Creative Commons Attribution-NonCommercial-NoDerivs (CC BY-NC-ND) licence. This licence only allows you to download this work and share it with others as long as you credit the authors, but you can't change the article in any way or use it commercially. More information and the full terms of the licence here: <https://creativecommons.org/licenses/>

Takedown

If you consider content in White Rose Research Online to be in breach of UK law, please notify us by emailing eprints@whiterose.ac.uk including the URL of the record and the reason for the withdrawal request.



eprints@whiterose.ac.uk
<https://eprints.whiterose.ac.uk/>



13th International Conference on Greenhouse Gas Control Technologies, GHGT-13, 14-18
November 2016, Lausanne, Switzerland

Sequential supplementary firing in combined cycle power plant with carbon capture: part-load operation scenarios in the context of EOR

Abigail González Díaz^{a,b,*}, Eva Sanchez Fernandez^c, Jon Gibbins^a, and Mathieu Lucquiaud^a

^aThe University of Edinburgh, school of Engineering, The King's Building, Edinburgh EH9 3JL

^bInstituto Nacional de Electricidad y Energías Limpias, Reforma 113, col. Palmira, Cuernavaca Morelo, Mexico. C.P. 62490.

^cHerriot-Watt University, Edinburgh, UK

Abstract

This paper extends previous work on sequential supplementary firing combined cycles (SSFCC) and evaluates their part-load operation in order to define operating strategies to maximise revenue from electricity and Enhanced Oil Recovery (EOR) over a range of fuel input. Sequential supplementary firing consists of burning additional fuel at different stages in the heat recovery steam generator (HRSG) to increase CO₂ concentration reduces the volumetric flow of the flue gases. It uses almost all of the oxygen in the flue gas and keeps the maximum gas temperature at around 820°C to avoid large additional capital costs in the HRSG. SSFCC This analysis is important in order to establish ways to maintain a minimum CO₂ flow for EOR when the power plant with CO₂ capture is at minimum stable generation.

Two alternatives to reduce power at part-load are evaluated: a subcritical steam cycle with a combination of variable inlet guide vanes and reduction in supplementary firing; and a strategy where the gas turbine is maintained at full output and the power output is solely reduced by adjusting the amount of supplementary firing in the HRSG.

© 2017 The Authors. Published by Elsevier Ltd. This is an open access article under the CC BY-NC-ND license (<http://creativecommons.org/licenses/by-nc-nd/4.0/>).

Peer-review under responsibility of the organizing committee of GHGT-13.

Keywords: Sequential supplementary firing; CO₂ capture; part-load operation

* Corresponding author. Tel.: +52 7773623811

E-mail address: abigail.gonzalez@iee.org.mx

1. Introduction

Previous work by Gonzalez et al [1] showed that Sequential Supplementary Firing Combined Cycles (SSFCC) compare favourably with natural gas combined cycle (NGCC) power plants integrated with MEA-based CO₂ capture, in the context of CO₂ sales for EOR in Mexico. Results from the study confirmed that the revenues from additional CO₂ production compared to conventional configurations could contribute to facilitating a roll-out of CCS in electricity sector in Mexico, and in other markets with EOR and low natural gas prices. Sequential combustion makes use of the excess oxygen in gas turbine exhaust gas to generate additional CO₂, but, unlike in conventional supplementary firing, allows keeping gas temperatures in the heat recovery steam generator below 820°C, avoiding a step change in capital costs. It marginally decreases relative energy requirements for solvent regeneration and amine degradation. Power plant models integrated with capture and compression process models of subcritical SSFCC gas-fired units show that the efficiency is 43% LHV compared to a conventional natural gas combined cycle power plant with the same capture technology of 51%. Although the efficiency is lower than the conventional configuration, the increment in the power output of the combined steam cycle leads a reduction of the number of gas turbines, at a similar power output to that of a conventional natural gas combined cycle. This has a positive impact on the number of absorbers and the capital costs of the post combustion capture plant by reducing the total volume of flue gas by half on a normalised basis. The relative reduction of overall capital costs is 15.3% for the subcritical combined cycle configuration with capture compared to a conventional configuration. For a gas price of \$2/MMBTU, the Total Revenue Requirement (TRR) - a metric combining levelised cost of electricity and revenue from EOR - of subcritical sequential supplementary firing is consistently lower than that of a conventional NGCC by 2.2 \$/MWh at 0 \$/tonneCO₂ and by 4.9 \$/MWh at \$50/tonneCO₂ [1]. The schematic diagram and the pinch diagram at 100% are shown in Figure 1 and Figure 2.

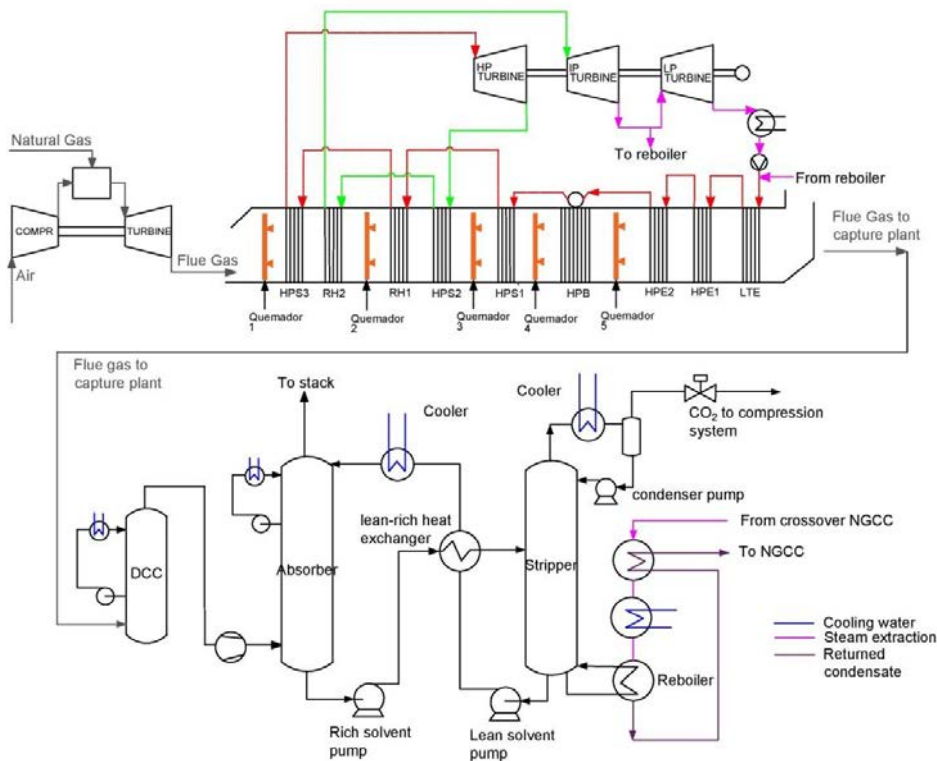

Fig. 1. Schematic process flow diagram of a subcritical sequential supplementary firing configuration with one GE 937 IFB / single pressure HRSG train combined with a single reheat steam cycle.

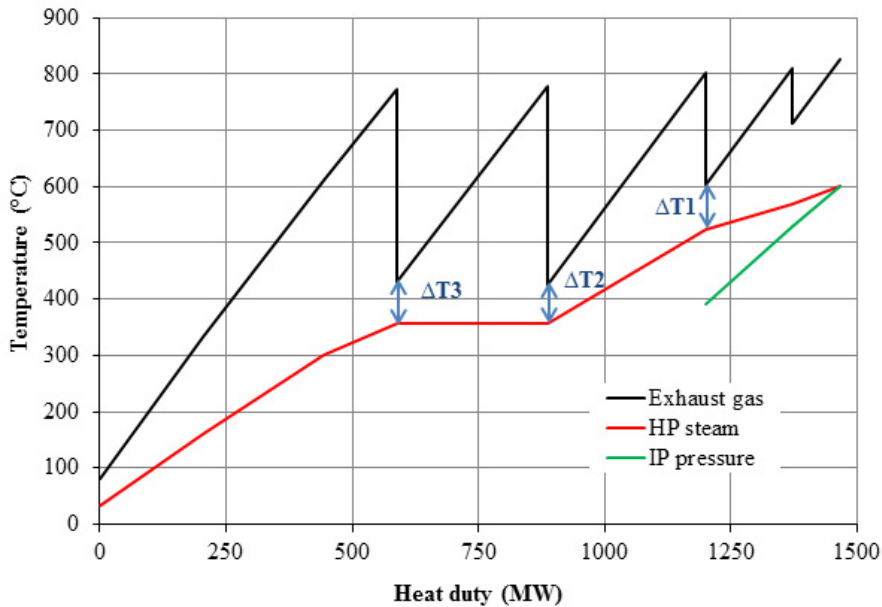

Fig. 2 Temperature/heat diagram of the Heat Recovery Steam Generator of a five stage sequential supplementary firing configuration with a single pressure HRSG, with a single reheat combined cycle and subcritical steam conditions (601.7°C, 601.5°C, 172.5 bar). The three pinch temperatures $\Delta T1$, $\Delta T2$, $\Delta T3$ are respectively 79°C, 70°C, 76°C.

Power plants operate at part-load due to variations in electricity demand caused by weather conditions, seasonal, daily and hourly changes in demand, e.g. there is a difference between week days and weekend days [2]. In the future, the electricity demand will also be influenced by the introduction of variable output renewable energy. It is expected that the installed wind power capacity will increase from 3.1% in 2014 to 12.7% in 2029 [2]. One characteristic of NGCC power plants is their flexibility to change power output according to electricity demand [3]. Therefore, it is necessary to evaluate and to ensure the continuity of flexibility in the operation of new alternatives proposed to decarbonise the electricity market. This paper is focused on evaluating SSFCC at part-load in order to ensure that it would not impose a constraint to this need for flexibility.

2. Modelling of the sequential supplementary firing power plant

The part-load modelling of the NGCC and SSFCC power plants developed in this study has four main units: the gas turbine, the HRSG, the steam cycle, and the capture plant and compressor unit. Their operation and the interaction with respectively the steam cycle and the desorbent is very important [4]. The gas turbine used in this work is the 9FB; the performance is taken from Thermoflow [5] data and validated with information from a thermal test of the 9FB published by [6]. Thermoflow is a suite of software which includes GT PRO, GT MASTER and Thermoflex programmes. GT PRO utilises a database of gas turbines with mapped performance curves taken from the manufactures [3]. The model for the HRSG and steam turbines of the NGCC is based on typical modelling principles, such as Stodola ellipse law for steam turbines, heat transfer fundamentals in the HRSG, and relevant pressure drop equations. In order to solve the equation system, the number of equations must be equal to the number of variables. The equation system is solved in Aspen Plus® to estimate the steady state performance at design and part-load conditions using an equation-oriented approach.

Steam turbine. Most steam turbines in combined cycle plants operate by sliding pressure operation and generally have no control stage with a nozzle group [7, 8]. A portion of the steam turbine with no extraction is defined by Equation 1 for its absorption capacity using the Law of Cones.

$$\frac{\dot{m}_S}{\dot{m}_{S0}} = \frac{\bar{V} x p_a}{\bar{V}_D x p_{a0}} \sqrt{\frac{p_{a0} x v_{a0}}{p_a x v_a}} \frac{\sqrt{1 - \left| \frac{p_w}{p_a} \right|^{\frac{n+1}{n}}}}{\sqrt{1 - \left| \frac{p_{w0}}{p_{a0}} \right|^{\frac{n+1}{n}}}} \quad (1)$$

Where \dot{m}_S is the steam mass flow (kg/s), p is the pressure (bar), v specific volume (m^3/kg), \bar{V} average swallowing capacity, n is the polytropic exponent, and the suffix 0 is the design point, a inlet, and w outlet of the steam turbine. In steam turbines, the absolute difference between the inlet and the outlet pressure is large so that the pressure ratio P_w/P_a is small and the ratio of the absorption capacity is close to 1. Equation 2 can then be simplified to Equation 3.

$$\frac{\dot{m}_S}{\dot{m}_{S0}} = \sqrt{\frac{p_{a0} x v_{a0}}{p_a x v_a}} \quad (2)$$

At part-load operation, the mass flow of steam generated is reduced and this equation is used to calculate the pressure across the turbine, and by extension the pump heads.

Overall heat-transfer coefficient. Two equations are needed to predict the behavior of all heat exchangers in the HRSG and the condenser [9]. The first one is the energy balance between the streams, considering heat loss by radiation and convection from the HRSG representing by Equations 3 and 4. The second equation is the heat transfer across the heat exchanger surface given by Equation 6 [10, 11].

$$Q = m_v (h_{vout} - h_{vin}) \quad (3)$$

$$Q = m_g (h_{gout} - h_{gin}) \quad (4)$$

If a counter-flow exchanger is used, the heat transfer equation allows calculating the product of the overall heat-transfer coefficient U and the exchange surface A by means of a logarithmic mean temperature difference, as in Equation 5. $U_D A$ is calculated at design condition and the new UA at part-load is calculated using the correlation shown in Equation 6.

$$Q = UA \frac{(T_{gin} - T_{vout}) - (T_{gout} - T_{vin})}{\ln \left(\frac{T_{gin} - T_{vout}}{T_{gout} - T_{vin}} \right)} \quad (5)$$

For economizers and evaporators

$$\frac{U_{op} A}{U_D A} = \left(\frac{m_{gop}}{m_{gD}} \right)^m \quad (7)$$

For superheaters, Equation 7 is

$$\frac{U_{op} A}{U_D A} = \left(\frac{m_{gop}}{m_{gD}} \right)^m \left(\frac{m_{vop}}{m_{vD}} \right)^n$$

Where Q heat transfer (kW), T_g is the temperature gas side (K), T_v is temperature vapour side (K), h_g Enthalpy gas side (kJ / s), h_v is the enthalpy vapour side (kJ/s), m_g is the mass flow of the gas (kg /s), m_v is the mass flow of the steam (kg /s), U_D is the overall heat-transfer coefficient at design condition (kW / m^2 K), U_{op} is the overall heat-transfer coefficient at part-load (kW / m^2 K). Suffix *in* and *out* denote inlet and outlet of the heat exchange, and suffix D is design and op operation at part-load condition. The empirical coefficients m (gas side) and n (vapour side) depend on the geometry and the heat transfer mechanism as shown in the Equation 8-9, and are dependent on the Nussel number. The coefficient n for subcritical vapour is 0.8 and for exhaust gas is 0.6 is estimated based on correlations of the Nussel number shown in Equation 8 and Equation 9 [12].

$$\frac{h_v D_i}{k_v} = 0.023 \left[\frac{D_i G_v}{\mu_v} \right]^{0.8} Pr_v^{0.33} \quad [8]$$

$$\frac{h_g D}{k_g} = 0.4 \left[\frac{D G_g}{\mu_g} \right]^{0.6} Pr_g^{0.33} \quad [9]$$

Where h_v is the heat transfer coefficient of the steam, (W/m²K), h_g is the heat transfer coefficient of the gas, (W/m²K), G_v is the steam mass flux, (kg/m²s), G_g is the gas mass flux, (kg/m²s), D_i is the diameter inside the tube (m), D is the tube diameter (m), k_v is the thermal conductivity of the steam W/mK, k_g is the thermal conductivity of the gas (W/mK), μ_v is the viscosity of the steam (kg/ms), μ_g is the viscosity of the gas (kg/m s), Pr_v is the Prandtl number steam side, Pr_g is the Prandtl number gas side.

In the evaporator, a phase transition from water to steam occurs, which means that the Equation 4 must be replaced by Equation 10.

$$Q = m_v (\Delta h_{evaporation}) \quad [10]$$

Where $\Delta h_{evaporation}$ is the evaporation enthalpy (kW). The $\Delta h_{evaporation}$ depends on the saturation pressure. The steam mass flow rate in the HRSG of the NGCC and subcritical SSFCC configurations at part-load is calculated taking into account the capacity of the evaporators to convert the water from saturated liquid to saturated vapour and the fact that the separation between the gas and the liquid phase in evaporators occurs through gravity. The steam mass flow rate in the HRSG of the NGCC and subcritical SSFCC at part-load is calculated considering the capacity of the size of the evaporators to convert the water from saturated liquid to saturated vapour. This is possible considering an additional assumption in the system: fully saturated vapour leaves the outlet of HP, IP, and LP boilers in a conventional NGCC and at the outlet of the HP boiler in subcritical SSFCC Figure 1.

Pressure drop. The pressure drop for each heat exchanger is estimated from a simple flow – pressure drop relationship given by Equation 11, where the equipment parameter is the loss coefficient k . At design condition the constant k is calculated using the pressure, temperature, and mass flow provided at full load after the optimisation. At part-load, k is keeping constant and now the variable calculated is the pressure at the outlet of the heat exchanger.

This equation is used to estimate the pressure drop from the cross-over pipe where steam is extracted for solvent regeneration to the solvent reboiler of the capture plant, which includes the pressure drop through the pipeline and de-superheating. The de-superheater is a heat exchanger to convert the steam going to the reboiler into saturation conditions.

$$\Delta p = P_{in} - P_{out} = km^2 \frac{\frac{1}{\rho_{in}} + \frac{1}{\rho_{out}}}{2} \quad [11]$$

Where

Δp	Pressure drop of steam through the heat exchanger (Pa)
m	Mass flow rate (kg/s)
ρ_{in} and ρ_{out}	Density at the inlet and outlet respectively (kg/m ³)
k	A constant (1/m ⁴)

3. Part-load Operation of sequential supplementary firing combined cycle with CO₂ capture

Power generation gas turbines typically operate at part-load with varying airflow rates using inlet guide vanes (IGV). The inlet guide vanes are also known as stators, and are located in front of the first stage of the compressor of a gas turbine engine. As the gas turbine changes its load, the steam turbine output adjusts automatically. The optimum mode to operate a NGCC plant is using variable IGV from 40% to 100% load of the gas turbine [7, 13]. The steam cycle becomes independent from the gas turbine when supplementary firing is incorporated [7], so that, unlike in conventional configuration, the fuel input can be adjusted either in the GT or in the HRSG in SSFCC

plants. These two operating strategies are modelled in this article:

- a. A combination of variable IGV in the gas turbine compressor and adjusting the amount of fuel in the burners of the HRSG
- b. Fixed IGV with the gas turbine operating at full load. The load of the power cycle, and by extension the net total power output, is controlled by varying the amount of the supplementary fuel in the burners in the HRSG

In both cases, the HRSG boiler is operated at part-load with sliding pressure.

The operating strategy of the SSFCC power plant is novel, since supplementary firing adds a level of permutation not encountered in conventional configurations. The selected configuration and operation strategy of CO₂ capture, compressor units, and the integration strategy between the power plant and the capture unit are based on [7, 14, 15, 16]. [7] evaluated two capture plant integrations:

- Controlled extraction by throttling the LP steam turbine, or fixed crossover pressure operation, and
- uncontrolled extraction with a floating IP/LP crossover pressure, as initially proposed in [17]

The latter is used in this study. Sanchez Fernandez and co-workers show that uncontrolled steam extraction provides better part load performance when compared to controlled extraction. The steam extraction pressure is directly related to the amount of steam extracted. The initial IP/LP crossover pressure is set so that, when the predicted amount of steam is extracted for solvent regeneration, its pressure falls or ‘floats’ to the desired value.

Part-load operating strategies of the various elements of SSFCC gas-fired power plant with carbon capture are summarised in table 1, where a conventional strategy of the NGCC is included for the purpose of comparing with subcritical SSFCC case.

Table 1. Lists of option for part-load operation for the power plant, CO₂ capture, and compressor unit

Power plant case	NGCC	Subcritical SSFCC	
Gas turbine control	Variable IGV	Fixed IGV	Variable IGV
HRSG	No supplementary firing	Sequential supplementary firing	Sequential supplementary firing
Steam cycle (Pressure and temperature)	Subcritical	Subcritical	Subcritical
Steam cycle control	Sliding pressure	Sliding pressure	Sliding pressure
Steam extraction	Uncontrolled extraction	Uncontrolled extraction	Uncontrolled extraction
Capture plant	<i>Constant</i> stripper pressure, <i>variable</i> reboiler Temperature and L/G for all cases		
CO ₂ compressor	IGV with CO ₂ recycle valve and constant pressure ratio (P _{inlet} and P _{outlet} constant)		

IGV = Inlet Guide Vanes; HRSG = Heat Recovery Steam Generation; L/G = Liquid to gas ratio in the absorber; NGCC= Natural Gas Combine Cycle; SSFCC= Sequential Supplementary Firing Combined Cycle

4. Results and discussions

4.1 Gas turbine operation with variable inlet guide vanes

The air/fuel ratio of the gas turbine has an important role not only for controlling the load, but also for controlling the temperature of the exhaust gas (TET). It is possible to change the air / fuel ratio by closing or opening the IGV. An elevated exhaust temperature compared to the design temperature is problematic for the last uncooled turbine stages, and the maximum permissible TET is attained 50°C above nominal ISO base load exhaust temperature (600°C in this case) [13, 7]. Figure 3 shows the path followed by the air / fuel ratio when the load of the gas turbine is changed from 100% to 40% and how it controls the variation of the exhaust temperature. The simulation results of the inlet temperature (TIT) in the gas turbine and of the air/fuel ratio at different loads are shown in Figure 4. The air / fuel ratio is kept relatively constant around 46.4 (-) between 100% - 80% of the gas turbine load in order to keep the turbine inlet temperature constant. Then, the exhaust gas temperature starts

increasing with decreasing load because of the reduction in the efficiency of the gas turbine shown in Figure 5. Below 80% load the air / fuel ratio increases in order to avoid a dramatic increment of the TET. Figure 3 shown that, at approximately 50% load, the increment over the design TET is 45°C. This value is in good agreement with [13, 7] where the maximum TET increment permissible is 50° above nominal ISO.

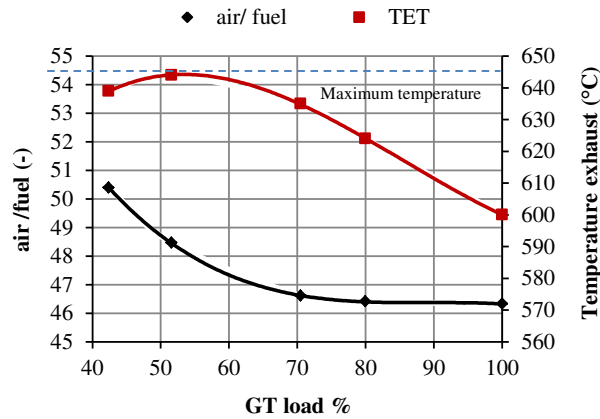

Fig 3. Gas turbine part-load operation with variable inlet guide vanes (IGV): Turbine Exhaust temperature for a range of loads and air/fuel ratios

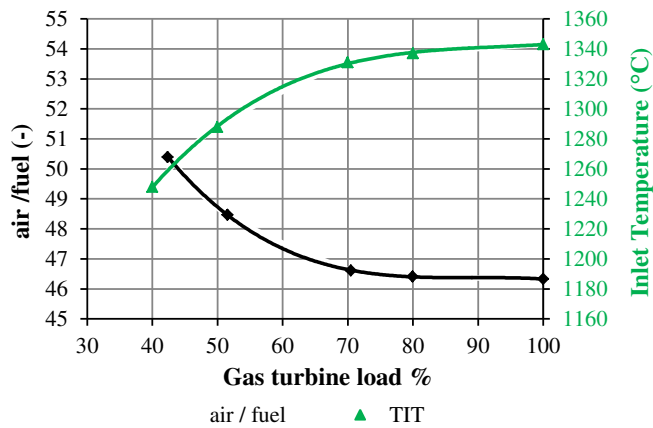

Fig 4. Gas turbine part-load operation with variable inlet guide vanes: Turbine inlet temperature for a range of loads and air/fuel ratios

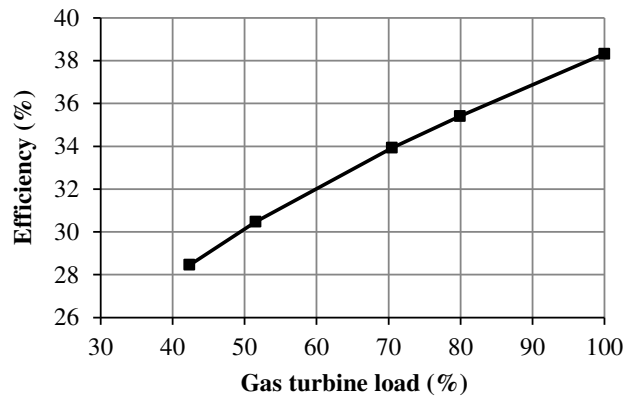

Fig 5. Part-load efficiency of the gas turbine

4.2 Combined cycle and heat recovery steam generator operation.

This section describes the part-load performance of a configuration where the desired load of the power cycle is achieved by two alternatives:

1. By using inlet guide vanes and reducing the supplementary fuel in the duct burners
2. By reducing the supplementary fuel in the duct burners with the gas turbine at full load (fixed IGV)

Reducing the minimum load at which a steam turbine can reliably operate is one way of optimising revenue for marginal base-load units during periods of low electrical demand. Although it is not unusual to operate power plants at load levels below the typical 25% with respect to full-load limits, steam turbines may experience undesirable damage at low flow conditions [18]. Under severe low flow conditions, the LP stages will subtract net power due to windage and freewheeling causing a significant temperature rise of the materials of the rotating and stationary components. Information of the allowable minimum steam flow steam turbine is commercial in confidence and is not provided by manufacturers in the public domain. [19] indicates that operation of the LP steam turbine above 20% is acceptable.

The reduction in gas temperature at the outlet of each burner of Figure 1 is shown in Figure 6. At 100% load, the main fuel demand is in the last two burners where the HP evaporator is located. A large amount of heat is needed to change the phase from saturated liquid to saturated vapor. The air / fuel ratio is shown in Figure 8, illustrating that combustion is leaner at 100% load, and the percentage of O₂ and CO₂ at part-load across the HRSG is shown in Figure 9 and Figure 10.

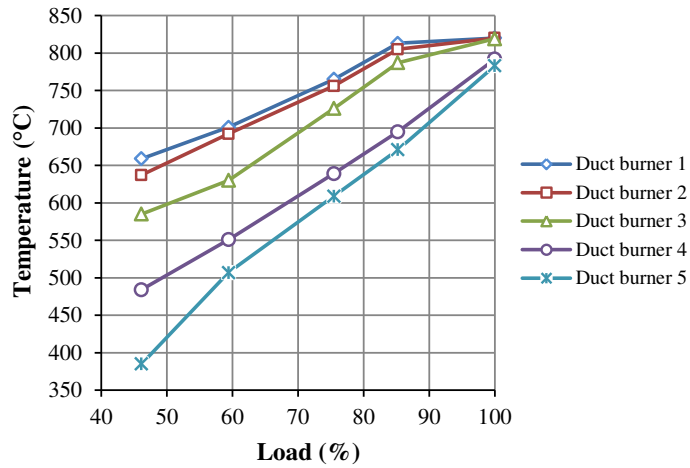

Fig 6. Flue gas temperature across the HRSG at part-load for a subcritical SSFCC power plant with fixed IGV and sliding pressure in the HRSG. The flue gas temperature in each duct-burner varies with the changes in load of the power plant, caused by variations of the natural gas mass flow and subsequent reductions of steam flow

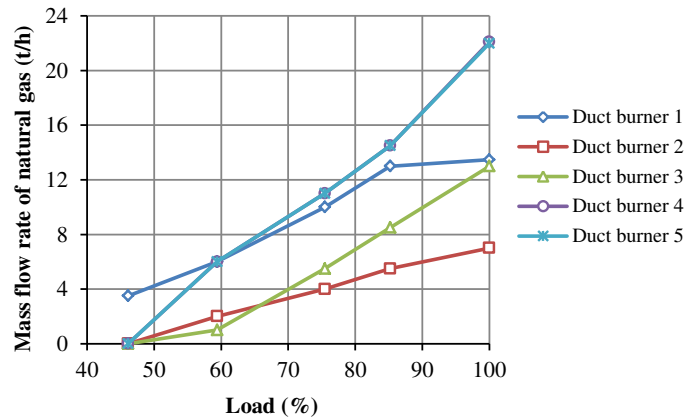

Fig7. Variation of the natural gas mass flow across the HRSG at part-load of a subcritical SSFCC power plant with fixed IGV and sliding pressure in the HRSG

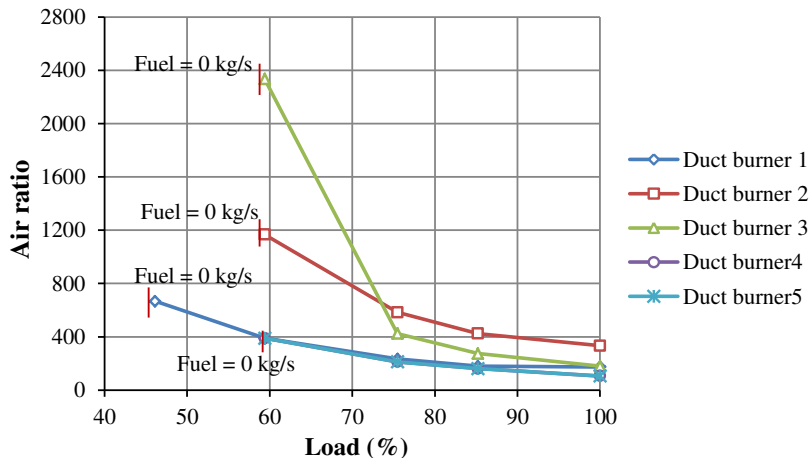

Fig 8. air / fuel ratio in each duct-burner at part-load for a subcritical SSFCC power plant with fixed IGV and sliding pressure. The variations are caused by a reduction of the natural gas mass flow to accommodate subsequent reductions of steam production

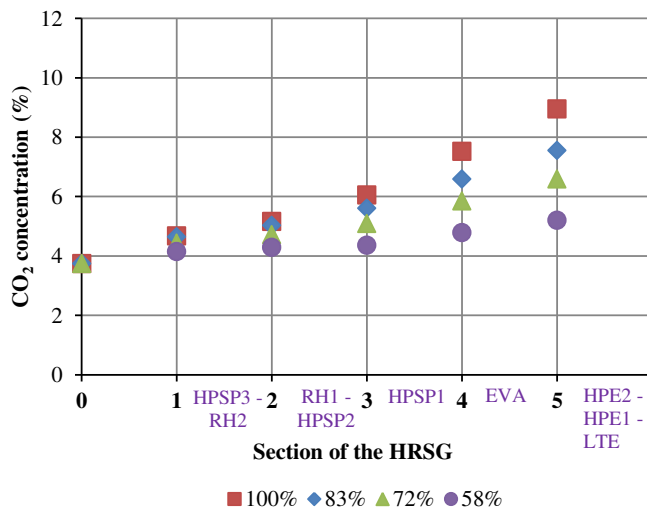

Fig 9. Variation of CO₂ concentrations across each section of the HRSG at different loads for a subcritical SSFCC with fixed IGV and sliding pressure in the HRSG. The acronyms used refer to Figure 1

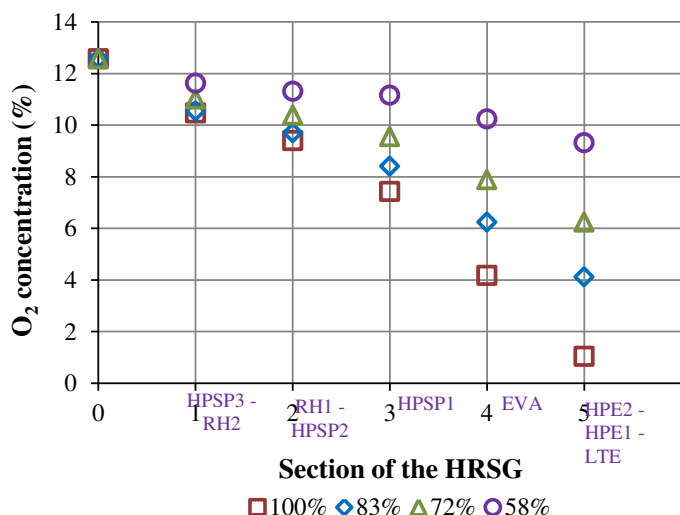

Fig 10. Variation of O₂ concentration across each section of the HRSG at different loads for a subcritical SSFCC with fixed IGV and sliding pressure in the HRSG. The acronyms used refer to Figure 1

4.3 CO₂ capture plant and compression unit

The CO₂ capture plant is simulated in Aspen plus[®] using a rate-based approach. A summary of relevant parameters for the part-load operation of a conventional NGCC plant with capture are shown in Table 2. The small reduction of the solvent temperature in the reboiler at load below 75%, is not favourable to the vapour-liquid equilibrium in the stripper because the extent of solvent regeneration is reduced and leads to higher CO₂ lean loading, as explained in [4]. The lean loading increases from 0.269 to 0.272 as indicated in Table 2 and the specific reboiler duty increases marginally from 3.56 to 3.65 GJ/tonneCO₂. At higher lean loadings, a larger L/G is needed to achieve the same 90% of CO₂ removal. The L/G is adjusted at each load to get 90% of CO₂ capture. It is increased from 1.47 to 1.6 when reducing load from 100% to 58%. This leads to providing more energy to compensate for the increase contribution of the sensible heat of the solvent to raise the temperature of the solvent to the stripper temperature.

Table 2. Capture plant process simulation at part-load of conventional natural gas combined cycle

Load of power plant	%	100	84	75	58
Capture level	%	90	90	90	90
CO ₂ captured	kg/s	69.2	60	55	45.6
Specific reboiler duty	GJ/tonneCO ₂	3.56	3.58	3.60	3.65
Lean loading		0.269	0.2752	0.273	0.272
Rich loading		0.4721	0.4725	0.4725	0.4721
Liquid to gas molar ratio (L/G)		1.47	1.53	1.5	1.6
Solvent circulation rate	kmol/s	65.6	59.3	53.5	48.6
Solvent side reboiler temperature	°C	120	120	119.5	118
Pressure in the reboiler	bar	1.9	1.9	1.9	1.9
Total steam extraction from IP/LP crossover	kg/s	111.2	106	98.08	96
LP turbine steam flow rate	kg/s	77.6	71.9	54.6	42.1
Fraction of steam extraction	(%)	0.59	0.596	0.642	0.695
Show it as a percentage					
Pressure crossover	bar	4.00	3.69	3.50	2.99

Table 3 shows the most important parameters of the capture plant of a subcritical SSFCC operated at part-load. The behaviour is similar to that of a conventional NGCC when operating between 100% and 75% load. However, the crossover pressure between the IP and LP turbine is 2 bar at 58%, which is lower than in the conventional

NGCC configuration (3 bar) at the same load. The strategy proposed by Sanchez Fernandez et al (2016) is then adopted, where “a combination of releasing stripper pressure and increasing the L/G ratio in the absorber” is used.

Table 3. Capture plant process simulation at part-load of conventional natural gas combined cycle

Load of power plant	%	100	84	75	58
Capture level	%	90	90	90	90
CO ₂ captured	kg/s	69.2	60	55	45.6
Specific reboiler duty	GJ/tonneCO ₂	3.56	3.58	3.60	3.65
Lean loading		0.269	0.2752	0.273	0.272
Rich loading		0.4721	0.4725	0.4725	0.4721
Liquid to gas molar ratio (L/G)		1.47	1.53	1.5	1.6
Solvent circulation rate	kmol/s	65.6	59.3	53.5	48.6
Solvent side reboiler temperature	°C	120	120	119.5	118
Pressure in the reboiler	bar	1.9	1.9	1.9	1.9
Total steam extraction from IP/LP crossover	kg/s	111.2	106	98.08	96
LP turbine steam flow rate	kg/s	77.6	71.9	54.6	42.1
Fraction of steam extraction Show it as a percentage	(%)	0.59	0.596	0.642	0.695
Pressure crossover	bar	4.00	3.34	2.75	1.90

Figure 11 shows the reduction of the crossover pressure causing lower operating temperatures in the reboiler and increasing the reboiler duty. At 58% load, the stripper pressure has to be released from 1.87 bar to 1.63 bar. The reboiler duty then increases from 3.44 MJ/tonne CO₂ to 3.88 MJ/tonne CO₂.

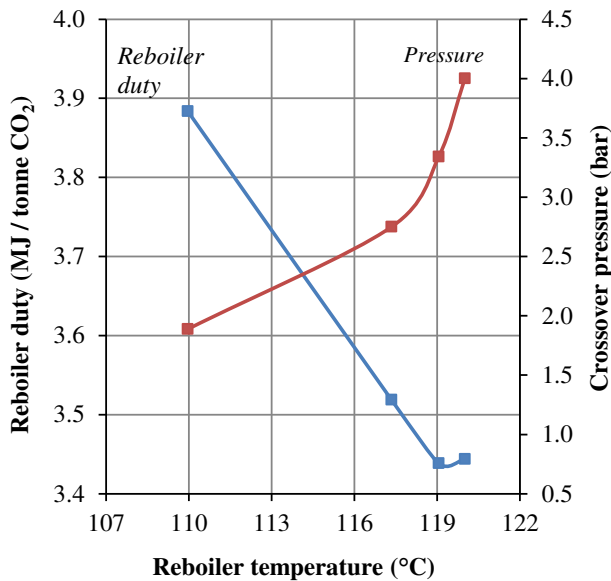

Fig 11. Reboiler duty and reboiler solvent temperature vary with changes in crossover pressure, caused by a reduction of steam cycle flow at part-load between 100% and 60% load, with 90% capture in the subcritical SSFCC with fixed IGV

Table 4. Capture plant process simulation at part-load of subcritical SSFCC sliding pressure boiler

Load of power plant	%	100	85	75	58
CO ₂ captured	kg/s	87.7	73.7	63.4	50.3
Capture level	%	90	90	90	90
Specific reboiler duty	GJ/tonneCO ₂	3.44	3.44	3.52	3.88
Lean loading		0.2821	0.284	0.3137	0.3623
Rich loading		0.4806	0.4785	0.4727	0.449
Liquid to gas molar ratio (L/G)		4.03	3.73	3.89	5.43
Solvent circulation rate	kmol/s	76.8	72.8	76.8	109.4
Solvent side reboiler temperature		120	119.0	117.3	110
Pressure in the reboiler	bar	1.87	1.87	1.87	1.64
Total steam extraction from IP/LP crossover to capture plant	kg/s	138	115	100	100
LP turbine steam flow rate	kg/s	237.6	182.8	144.6	67.7
Fraction of steam extraction	kg/s	0.37	0.39	0.41	0.60
Crossover pressure	bar	4	3.34	2.75	1.90

Two trains with a similar gear-type centrifugal compressor with seven stages and intercooling after each stage are used in all configurations to compress the produced CO₂ to 150 bar for EOR purposes. The inlet and outlet pressures in each stage of the compressor are constant at part-load for the conventional NGCC and for the subcritical SSFCC between 100% and 75%. However, for SSFCC configuration at 58% load, as the pressure in the stripper is released, the inlet pressure of the first stage of the compressor reduces. Below 75% load, a fraction of the compressed CO₂ must be recycled in order to avoid surge and prevent damage to the compressor (Liebenthal and Kather, 2011; Kiameh, 2013). Recycling compressed CO₂ increases the auxiliary electricity consumption. Table 5 summarises the auxiliary power consumption of the CO₂ compression unit at various load.

Table 5. Auxiliary power consumption of the CO₂ compressor unit at part-load operation

Load of power plant	%	100	85	75	58
NGCC	MW	22.38	21.31	20.00	19.8
Subcritical SSFCC	MW	31.57	31.67	23.32	23.30

5. Variation of the efficiency at part-load

One strategy to maximize power output at part-load with sequential supplementary firing is to operate the gas turbine at full load to maintain high efficiency and adjust the total net power output by varying the amount of fuel input in the duct burners. Since the marginal change in thermal efficiency of a steam cycle at part-load is smaller than that of a gas turbine, this section demonstrates that this is the most thermally efficient way to operate a SSFCC plant. The efficiencies for the outlined cases: a subcritical SSFCC with fixed IGV, a subcritical SSFCC with variable IGV and a conventional NGCC with variable IGV, all with CO₂ capture, results are shown in Figure 12.

The efficiency of the conventional NGCC configuration with capture decreases from 51.1% to 44.5% when the load of the cycle is reduced from 100% to 58%. The result is in good agreement with the publication of [8]. The efficiency drops is caused by the reduction of efficiency of the gas turbine with the IGV at part-load. The fraction of steam extraction for solvent regeneration from the LP turbine is increased, as shown in Table 2. Recycling compressed CO₂ at loads below 75% penalise even further the net efficiency.

For subcritical SSFCC configurations, a different trend is observed. The reduction of supplementary gas firing at part-load implies that the fraction of natural gas burnt at high efficiency in the gas turbine increases. In addition, there is a positive effect due to the increase in efficiency of the steam cycle at part-load when less fuel is used in the HRSG. With variable IGV, the efficiency reduces from 43.15% to 42.22% when the load is reduced from 100% to 60%. With fixed IGV and the gas turbine operated at full output and maximum efficiency across the range of load, the efficiency increases from 43.15% to 45.78% when the load is reduced from 100% to 60%.

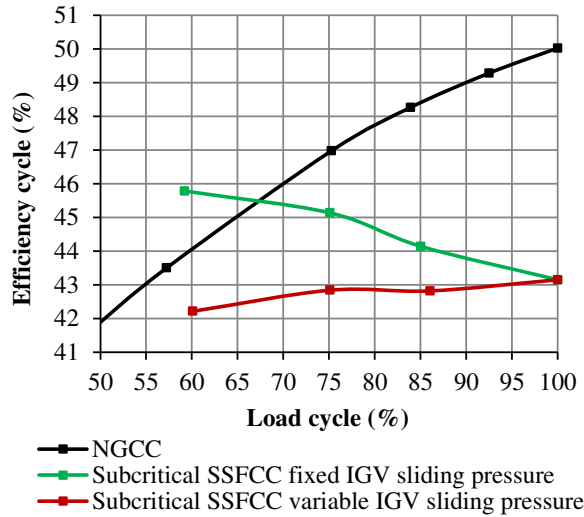

Fig12. Efficiency at part-load operation for Subcritical SSFCC with fixed and variable IGV cases with CO₂ capture and compressor unit.

It is worth noting that the total amount of CO₂ by unit of electricity decreases at part-load, as shown in Figure 13, and so does the additional revenue from CO₂ sales. The subcritical SSFCC configuration with varying IGV generates more CO₂ per unit of electricity at part-load, due to the lower efficiency.

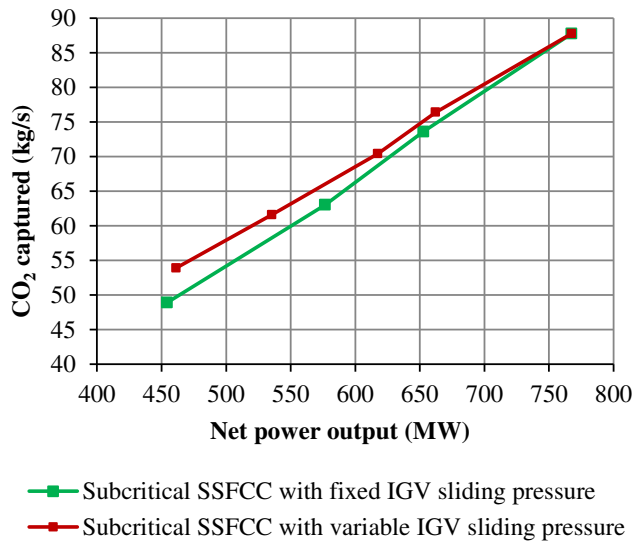

Fig 13. Variation of CO₂ generated with power output of subcritical SSFCC with fixed and variable IGV at part-load, sliding pressure in the boiler

6. Conclusion

The operating strategy proposed for part-load operation of SSFCC plant configurations maximises part-load efficiency by shifting all of the output reduction to the combined cycle and keeping the amount of work generated in the gas turbine to a maximum.

The temperature in each duct burner decreases at part-load because of the reduction of the mass flow of the fuel.

The reduction of the mass flow of natural gas in duct burners increases the efficiency of SSFCC. The optimisation of steady state part-load performance shows that reducing the power output by adjusting supplementary fuel keeps the gas turbine operating at full load and at maximum efficiency when the net power plant output is reduced from 100% to 58%. The thermal efficiency of subcritical sequential supplementary firing at part-load is optimised, in terms of efficiency and the short run marginal cost. Results confirm that the net thermal efficiency increases at part-load with SSFCC with fixed IGV compared with to a conventional NGCC and to SSFCC with variable IGV configuration where efficiency reduces at part-load operation. When operated SSFCC at gas turbine at full load (fixed IGV) at part-load, this show greater operational flexibility by utilising the additional degree of freedom associated with the combustion of natural gas in the HRSG to change power output according to electricity demand and to ensure continuity of CO₂ supply when exposed to variation in electricity prices. If CO₂-EOR is not a constrain, the optimum way to operate SSFCC at part-load would be keeping the load of the gas turbine at full load and varying the load reducing the fuel in the duct burners.

Acknowledgements

The authors would like to thank the Mexican National Council for Science and Technology (CONACyT) for financial support to Abigail Gonzalez Diaz, the GAS-FACTS project funded by the UK EPSRC (EP/J020788/1)

References

- [1] González Díaz, A., E. Sánchez Fernández, J. Gibbins, and M. Lucquiaud, “Sequential supplementary firing in natural gas combined cycle with carbon capture: A technology option for Mexico for low-carbon electricity generation and CO₂ enhanced oil recovery”, *International Journal of Greenhouse Gas Control*, 51 (2016) 330–345.
- [2] Mexican Ministry of Energy, 2015. Mexican electric sector prospective 2015-2029. In: *Annually Revision of the Mexican electricity sector (Version in Spanish)*.
https://www.gob.mx/cms/uploads/attachment/file/44328/Prospectiva_del_Sector_Electrico.pdf
- [3] IEAGHG 2012. CO₂ capture at gas fired power plants. *International Energy Agency Greehouse Gas. Report number: 2012/8*.
- [4] Sanchez Fernandez, E., Lucquiaud M., Chalmers H., Khakhariab P., Goetheerb E., and Gibbins J., 2016. Operational flexibility options in power plants with integrated post-combustion capture. *International Journal of Greenhouse Gas Control*.
- [5] Thermoflow, 2013 Inc, <http://www.thermoflow.com>, 2013.
- [6] Ol'khovskii, G., et al, 2013. Thermal Tests of the 9FB Gas Turbine Unit Produced by General Electric, *Thermal engineering* vol. 60 No. 9, pp 607-612.
- [7] Kehlhofer, P., Hannemann, F., Stirnimann, F., and Rukes, B., 2009. *Combined-cycle gas and steam turbine power plant*, 3rd edition. PennWell corporation.
- [8] Rezazadeh, F., Galea, W., Hughesb, K., Pourkashania, M., 2015. Performance viability of a natural gas fired combined cycle power plant integrated with post-combustion CO₂ capture at part-load and temporary non-capture operations. *International Journal of Greenhouse Gas Control* 39 (2015) 397–406.
- [9] Rovira, A., Valdes, M., Duran, M., 2010. A model to predict the behaviour at part load operation of once-through heat recovery steam generators working with water at supercritical pressure. *Applied Thermal Engineering* 30(13):1652-1658.
- [10] Valdes, M., Rovira, A., Duran, M.D., 2004. Influence of the heat recovery steam generator design parameters on the thermoeconomic performances of combined cycle gas turbine power plants. *Int. J. Energy Res.* 28, 1255 - 1267.
- [11] Gonzalez, J., Gonzalez D. A., Mariño C., 2007. Diagnostics of the operation of power plants, *POWER2007 ASME Power 2007 July 17-19, 2007, San Antonio, Texas*.
- [12] *Steam its generation and use*, 2005. The Babcock & Wilcox Company, 2005. Edition 41
- [13] Elmasri, M., 2002. *Gas turbine components - turbine*, Section 9: single pressure HRB/CC Thermodynamics.
- [14] Van der Wijk, P.C., Brouwer, A.S., Van den Broek, M., Slot, T., Stienstra, G., Van der Veen, W., Faaij, A.P.C.,

2014. Benefits of coal-fired power generation with flexible CCS in a future northwest European power system with large scale wind power. *International Journal of Greenhouse Gas Control* 28, 216-233.
- [15] Kvamsdal, H.M., Jakobsen, J.P., Hoff, K.A., 2009. Dynamic modelling and simulation of a CO₂ absorber column for post-combustion CO₂ capture. *Chemical Engineering and Processing: Process Intensification* 48, 135-144.
- [16] Liebenthal, U., and Kather A., 2011. Design and Off-Design Behaviour of a CO₂ Compressor for a Post-Combustion CO₂ Capture Process. 5th International Conference on Clean Coal Technologies, Saragoza, Spain, 8 - 12 May 2011.
- [17] Lucquiaud, M., Gibbins, J., 2009. Retrofitting CO₂ capture ready fossil plants with postcombustion capture. Part 1: Requirements for supercritical pulverized coal plants using solventbased flue gas scrubbing. *Proceedings of the Institution of Mechanical Engineers, Part A: Journal of Power and Energy* 223, 213-226.
- [18] Cotton, 1994. Evaluating and Improving Steam Turbine Performance
- [19] Mitsubishi Heavy Industries, Ltd. Technical Review Vol. 44 No. 4 (Dec. 2007).
- [20] Jonshagen, K., Sipocz, N., Genrup, M., 2011. A novel approach of retrofitting a combined cycle with post combustion CO₂ capture. *Journal of engineering for gas turbine and power*, vol. 133.