



This is a repository copy of *Global identification of electrical and mechanical parameters in PMSM drive based on dynamic self-learning PSO*.

White Rose Research Online URL for this paper:
<http://eprints.whiterose.ac.uk/126906/>

Version: Accepted Version

Article:

Liu, Z., Wei, H. orcid.org/0000-0002-4704-7346, Li, X.H. et al. (2 more authors) (2018) Global identification of electrical and mechanical parameters in PMSM drive based on dynamic self-learning PSO. *IEEE Transactions on Power Electronics*, 33 (12). pp. 10858-10871. ISSN 0885-8993

<https://doi.org/10.1109/TPEL.2018.2801331>

© 2018 IEEE. Personal use of this material is permitted. Permission from IEEE must be obtained for all other users, including reprinting/ republishing this material for advertising or promotional purposes, creating new collective works for resale or redistribution to servers or lists, or reuse of any copyrighted components of this work in other works. Reproduced in accordance with the publisher's self-archiving policy.

Reuse

Items deposited in White Rose Research Online are protected by copyright, with all rights reserved unless indicated otherwise. They may be downloaded and/or printed for private study, or other acts as permitted by national copyright laws. The publisher or other rights holders may allow further reproduction and re-use of the full text version. This is indicated by the licence information on the White Rose Research Online record for the item.

Takedown

If you consider content in White Rose Research Online to be in breach of UK law, please notify us by emailing eprints@whiterose.ac.uk including the URL of the record and the reason for the withdrawal request.



eprints@whiterose.ac.uk
<https://eprints.whiterose.ac.uk/>

Global Identification of Electrical and Mechanical Parameters in PMSM Drive based on Dynamic Self-Learning PSO

Zhao-Hua Liu, Member, IEEE, Hua-Liang Wei, Kan Liu, Member, IEEE, and Qing-Chang Zhong, Fellow, IEEE

Abstract: A global parameter estimation method for a PMSM drive system is proposed, where the electrical parameters, mechanical parameters and voltage-source-inverter (VSI) nonlinearity are regarded as a whole and parameter estimation is formulated as a single parameter optimization model. A dynamic learning estimator is proposed for tracking the electrical parameters, mechanical parameters and VSI of PMSM drive by using dynamic self learning particle swarm optimization (DSLPSO). In DSLPSO, a novel movement modification equation with dynamic exemplar learning strategy is designed to ensure its diversity and achieve a reasonable tradeoff between the exploitation and exploration during the search process. Moreover, a nonlinear multi-scale based interactive learning operator is introduced for accelerating the convergence speed of the Pbest particles; meanwhile a dynamic opposition-based learning (OBL) strategy is designed to facilitate the gBest particle to explore a potentially better region. The proposed algorithm is applied to parameter estimation for a PMSM drive system. The results show that the proposed method has better performance in tracking the variation of electrical parameters, and estimating the immeasurable mechanical parameters and the VSI disturbance voltage simultaneously.

Index Terms: particle swarm optimization (PSO), dynamic self learning, interactive learning, parameter estimation, electrical parameters, mechanical parameters, voltage-source-inverter (VSI), permanent magnet synchronous machines (PMSMs).

I. INTRODUCTION¹

RECENTLY, permanent magnet synchronous machines (PMSMs) are widely used in high-performance applications due to its high efficiency, high power density, and good dynamical performance [1]-[3]. The parameter accuracy of both the electrical and mechanical models is of great importance for condition monitoring and fault detection, speed regulation, and control system

Z.-H. Liu is with the School of Information and Electrical Engineering, Hunan University of Science and Technology, Xiangtan, 411201, China (e-mail:zhliu@hnu.edu.cn).

H.-L. Wei is with the Department of Automatic Control and Systems Engineering, The University of Sheffield, Sheffield S1 3JD, U.K.(w.huiliang@sheffield.ac.uk).

K.Liu is with the Control Systems Research Group, Loughborough University, Loughborough LE11 3TU, U.K (email: k.liu3@lboro.ac.uk).

Q.-C. Zhong is with Department of Electrical and Computer Engineering, Illinois Institute of Technology, 10 W 35th Street, IIT Tower 16C6-2, Chicago, IL, USA. (email:zhongqc@ieec.org).

coefficient adjustment in a PMSM system [4]-[12]. It is known that electrical parameters, such as winding resistance, dq-axis inductances, and rotor PM flux linkage usually need to be known for the current loop controller design and system behavior evaluation. A high-performance controller is highly dependent on the accurate knowledge of electromagnetic parameters [6]. For example, the value of rotor PM flux linkage in PMSM drives is needed for torque control during a normal operation [9], the winding resistance and dq-axis inductances are essential for the design of current loop controllers [10]. In addition, any change of electrical parameters is also considered as an indicator for the change of system operation status. For example, the inter-turn short circuit can result in an abrupt change in dq-axis inductance and winding resistance [4], the demagnetization can result in a sudden decrease in the amplitude of PM flux linkage [7]. At the same time, the mechanical parameters such as moment of inertia and viscous friction coefficients are critical to the design of dynamic performance speed-loop controllers [11]. Therefore, obtaining accurate values of motor parameters can help improve control performance of the whole PMSM system. In reality, these electrical and mechanical parameters are usually unknown to the users. Accurate estimation of these motor parameters are sometime quite difficult due to the fact that they may change during drive operation as the PMSM drive is a nonlinear time-varying system, whose parameters are sensitive to the change of environmental conditions such as temperature, mechanical loads, etc. [12]. For example, the winding resistance can easily change along with the variation of temperature, and the rotor flux linkage of a PMSM varies with the change of temperature or magnetic density [6]. The moment of inertia usually varies with the shape and the dimensions of mechanical loads.

Therefore, in order to obtain reliable electrical and mechanical parameters of PMSM, a suitable parameter estimation method is needed. Many parameter estimation methods have been proposed. Some auxiliary equipment may be required in most of the existing parameter estimation methods to assist machine parameter identification such as external sensors, function generator, and spectrum analyzer [13]-[15]. However, the estimation accuracy of such a solution (i.e. with auxiliary equipment) relies on the accuracy of the measurement equipment used. Additionally, the mechanical parameters of a PMSM system are usually immeasurable. In practical engineering, ideally system identification methodology is used to directly estimate the needed parameters based on regular system input/output signal instead of using additional measurement instruments [16]. In the literature, commonly used parameter estimation algorithms include extended Kalman filter (EKF) [17], model reference adaptive system (MRAS) [18] [19], recursive least-squares (RLS) [20][21], observer-based method [22]-[25], and artificial neural networks (ANN) [26]. However, with the increasing complexity of operation conditions, these methods may not always work well. For example, in [2] it was proposed to use self-commissioning technique to estimate PMSM parameters under standstill before the start of machine. However, this method cannot estimate the permanent magnet when the machine is not running. EKF is usually used for the estimation of motor parameters including the winding resistance and rotor flux linkage [17]; this method, however, may be difficult for real applications due to the sensitivity to noise and highly computational burden in practical operation. In [18]

and [19], a MRAS estimator was proposed to estimate some machine parameters by fixing the rest parameter to their nominal values. However, the resulting parameter estimates given by MRAS can be biased as the PMSM parameters are varying nonlinearly, thus the nominal value is usually mismatching the actual parameter values, and it may converge to incorrect parameter values. Thus, the MRAS estimators cannot simultaneously estimate all electrical parameters in the circuit model of a PMSM. In comparison with other algorithms, RLS possesses a good property of rapid convergence rate, but the algorithm may suffer from deterioration of accuracy since it requires model reduction and approximation for linear parameterization [20]. Recently, observer-based parameter estimation approaches, including disturbance observer, sliding-mode observer and adaptive observer are attracting widespread interest and employed to estimate the parameters of PMSM due to their simplicity to implement [11], [21]-[24]. For example, a state observer for estimating motor disturbance and mechanical parameters is presented in [22]. In [23], an adaptive observer combined with a high-frequency signal injection technique was investigated to estimate the stator resistance and the rotor PM flux linkage in PMSM drives. In [24], a sliding-mode flux observer was used for flux estimation, and another improved sliding-mode observer is proposed for the estimation of the mechanical parameters of PMSM in [11]. Although the observer based methods in [11], [21]-[24] can achieve good performance and are able to estimate the machine parameters accurately, they are not robust enough when dealing with the uncertainties in machine parameters. ANN based iterative computations were also proposed for parameter estimation for PMSM in [25]; it was demonstrated through numerical experiments that such an approach could get stuck in local minima or over fitting if the tuning criteria were improperly conducted [26].

Bio-inspired search and optimization methods provide an ideal and automated solution to parameter estimation for PMSM systems using regularly measured data and properly defined objective functions. Particularly, the particle swarm optimization (PSO) algorithm is a nature-inspired algorithm with several advantages, such as simple implementation, fast convergence speed, and parallel search in a solution space, and is powerful in dealing with multivariate parameter optimization problems. The PSO algorithm has been employed in parameter estimation for electrical machines [26]-[31]. For example, in [28] an improved PSO method, combined with a new crossover operation, was proposed for the estimation of the unknown composite load model parameters. In [29], a novel application of the improved PSO was reported for parameter estimation of an induction machine by investigating new movement equation and designing a new coefficient adjustment strategy. A PSO-based estimator was proposed in [31] and [32], which is effective in estimating the stator resistance and the rotor flux linkage, or the d-axis inductances and q-axis inductances but the method cannot satisfactorily estimate all machine parameters simultaneously, since the basic PSO used is easy to get trapped in local minima when dealing with time-varying multiple parameter optimization problem. In [33], a collaborative evolutionary PSO, combined with an artificial immune system (AIS), was developed to improve the estimation performance of multiple PMSM system parameters. However, the computational load of this method is heavy though it obtains

good accuracy. To speed up the search process of swarm, a parallel co-evolutionary immune PSO algorithm was proposed for parameter estimation and temperature monitoring of a PMSM [34]; the execution efficiency of the method was greatly improved by taking advantage of massive parallelism in graphics processing unit (GPU). Most recently, a dynamic particle swarm optimization with learning strategy (DPSO-LS) was proposed for key parameter estimation for PMSM, where the VSI nonlinearities combined machine parameters were estimated simultaneously [35]. Nevertheless, the existing PSO-based parameter estimators of PMSM are dedicated to estimate electrical parameters, little attention has been paid for estimating all electrical parameter and mechanical parameters simultaneously. From the existing literatures, we can conclude that little work has been done for estimating all electrical parameter and mechanical parameters simultaneously. For example, [27] proposed to estimate combined moment of inertia and viscous friction coefficients with the aid of the estimated rotor PM flux linkage. However, the estimation of rotor PM flux linkage did not take into account other cases e.g. by fixing nominal value of other machine parameters such as winding resistance and the inductances, together with the influence of voltage-source inverter (VSI) nonlinearity. Therefore, the estimation accuracy of rotor PM flux linkage can suffer from the variation of other machine parameters and the unconsidered VSI nonlinearity. Consequently, the inaccuracy of estimated electrical parameters would in turn affect the accuracy of the estimation of mechanical parameters. Giving that the parameters of the system inherently impact on each other, it is a big challenge to obtain reliable parameter estimates using conventional parameter estimation methods. Thus, the development of a high performance learning estimator for the identification of PMSM electrical and mechanical parameters, together with the VSI nonlinearity, is still highly demanded.

For high-performance control system design and safe operation, comprehensive modeling efforts is always required, i.e., the electrical, mechanical and VSI parameters have to be precisely identified. This paper aims to achieve better performance in parameters estimation for PMSM systems. A new global parameter identification method is proposed for the estimation of electrical and mechanical parameters of a PMSM drive, where the electrical parameters, mechanical parameters, and voltage-source-inverter (VSI) nonlinearity are regarded as a whole and parameter estimation is formulated as a single optimization problem. To obtain global parameter estimates, a dynamic learning estimator is introduced for tracking the electrical and mechanical parameters of PMSM drive by using dynamic self learning particle swarm optimization (DSLPSO). In DSLPSO, a novel movement modification equation with dynamic exemplar learning strategy is designed to ensure its diversity and meanwhile effectively manage the exploitation and exploration during the search process. Moreover, a nonlinear multi-scale based learning operator is defined for accelerating the convergence speed of the Pbest particles, and a dynamic opposition-based learning (OBL) strategy is designed to facilitate the gBest particle to explore a potentially better region. The proposed method is applied to estimate the parameters of a PMSM drive. The results show that the proposed method has better performance in tracking the variation of electrical parameters and estimating the immeasurable mechanical parameters and the VSI disturbance

voltage simultaneously.

The remainder of this paper is organized as follows. In section II, a brief introduction of PMSM model is provided and the estimation of parameters for PMSM is analyzed. In section III, a dynamic learning estimator is presented for tracking the electrical and mechanical parameters of PMSM drive by using dynamic self learning particle swarm optimization (DSLPSO) is proposed, where the principle, mathematical model and implementation procedure of the algorithm are illustrated. Experimental results and analysis are given in section IV. Finally, conclusions and future work are presented in section V.

II. PMSM MODEL AND DESIGN OF PARAMETER ESTIMATION MODEL

A. PMSM Model

In this section, the modeling of VSI nonlinearity in synchronous rotating reference frame will be discussed. Assuming that the PMSM is of negligible saturation and losses inside cores and magnets, the PMSM can be partitioned into two subsystems, namely, the electrical system and the mechanical system [36]. The electrical and mechanical equations of PMSM in dq-axis reference frame are usually expressed as

$$u_d = R i_d + L_d \frac{di_d}{dt} - L_q P \omega i_q \quad (1a)$$

$$u_q = R i_q + L_q \frac{di_q}{dt} + L_d P \omega i_d + \psi_m P \omega \quad (1b)$$

$$T_e = 1.5P[\psi_m i_q + (L_d - L_q) i_d i_q] \quad (1c)$$

$$J \frac{d\omega}{dt} = T_e - B\omega - T_m \quad (1d)$$

where P is pole pairs, ω is mechanical angular speed, u_d , u_q , i_d and i_q are dq-axis stator voltage and current, and T_e is electromagnetic torque. The elements of the electrical parameter set $\{R, \psi_m, L_d, \text{ and } L_q\}$ represent the motor winding resistance, PM flux linkage, d-axis and q-axis inductances, respectively; the elements of the mechanical parameter set $\{B, J \text{ and } T_m\}$ are the viscous friction coefficient, moment of inertia and load torque, respectively. It should be noted that both B and J are generally time invariant for the same operation condition of a PMSM control system, but electrical parameters are always time varying.

PMSM is usually fed by a voltage source inverter (VSI). The reference voltages, used for the parameter estimator and measured from the output voltage of the current controllers in a PMSM vector control system, are denoted as u_d^* , u_q^* . The PMSM dq-axis voltage equations with the consideration of the VSI nonlinearity are expressed as

$$u_d^* = R i_d + L_d \frac{di_d}{dt} - L_q P \omega i_q - D_d(k) V_{\text{dead}} \quad (2a)$$

$$u_q^* = R i_q + L_q \frac{di_q}{dt} + L_d P \omega i_d + \psi_m P \omega - D_q(k) V_{\text{dead}} \quad (2b)$$

where D_d and D_q are periodical functions of the rotor position and can be expressed as [37]:

B.

$$\begin{bmatrix} D_d(k) \\ D_q(k) \end{bmatrix} = 2 \begin{bmatrix} \cos(\theta) & \cos(\theta - \frac{2\pi}{3}) & \cos(\theta + \frac{2\pi}{3}) \\ -\sin(\theta) & -\sin(\theta - \frac{2\pi}{3}) & \sin(\theta - \frac{\pi}{3}) \end{bmatrix} \begin{bmatrix} \text{sign}(i_{as}) \\ \text{sign}(i_{bs}) \\ \text{sign}(i_{cs}) \end{bmatrix} \quad (3)$$

with i_{as} , i_{bs} , i_{cs} being the stator abc three-phase currents (A).

$$\text{sign} = \begin{cases} 1 & , i \geq 0 \\ -1, & i < 0 \end{cases} \quad (4)$$

The variable V_{dead} is the distorted voltage caused by the VSI nonlinearity, and can be represented as

$$V_{\text{dead}} = \frac{T_{\text{dead}} + T_{\text{on}} - T_{\text{off}}}{T_s} \cdot (V_{\text{dc}} - V_{\text{sat}} + V_d) + \frac{V_{\text{sat}} + V_d}{2} \quad (5)$$

where T_{dead} , T_{on} , T_{off} , V_{dc} , V_{sat} and V_d are the dead-time period, turn-on, turn-off times of the switching device, the actual and measured real-time dc bus voltages, the saturation voltage drop of the active switch and the forward voltage drop of the free wheeling diode, respectively. In (5), the VSI nonlinearity introduces the distorted voltage terms $D_d \cdot V_{\text{dead}}$ and $D_q \cdot V_{\text{dead}}$ into the voltage equation of PMSM. Note that V_{dead} is difficult to measure as the dead-time period, switching times and voltage drops of switching device vary with the operating conditions. If V_{dead} is ignored, it may introduce an error into the parameter estimation of the machine and affect motor parameter identification results. The steady-state discrete equations of (2) are

$$u_d^* = R i_d - L_q P \omega i_q - D_d(k) V_{\text{dead}} \quad (6a)$$

$$u_q^* = R i_q + L_d P \omega i_d + \psi_m P \omega - D_q(k) V_{\text{dead}} \quad (6b)$$

The electrical parameters $\{R, \psi_m, L_d, L_q\}$ and VSI distorted voltage (V_{dead}) need to be identified from experimental data. As shown in (6), there are five machine parameters, but the rank number of PMSM voltage equation (6) is two, so the rank of (6) is unequal to the number of parameters, thus, it is impossible to estimate five parameters in the circuit model of PMSM, simultaneously.

Under the condition of no load, i.e., $T_m = 0$, and with $i_d = 0$, (1d) can be simplified as

$$J \frac{d\omega}{dt} = 1.5 P \psi_m i_q - B \omega \quad (7)$$

The mechanical parameters $\{J, B\}$ need to be identified, however, it is impossible to estimate two parameters with this single motion equation.

B PMSM Electrical and Mechanical Parameters Estimator Design Considering VSI Nonlinearity

A total of seven parameters (i.e., $R, L_d, L_q, \psi_m, V_{\text{dead}}, B, J$) need to be estimated, therefore seven equations need to be designed for system identifiability; it needs five voltage equations for the estimation of electrical parameters and VSI distorted voltage

V_{dead} , together with two motion equation for the estimation of mechanical parameters. A schematic diagram of the estimation and mathematical model is shown in Fig.1.

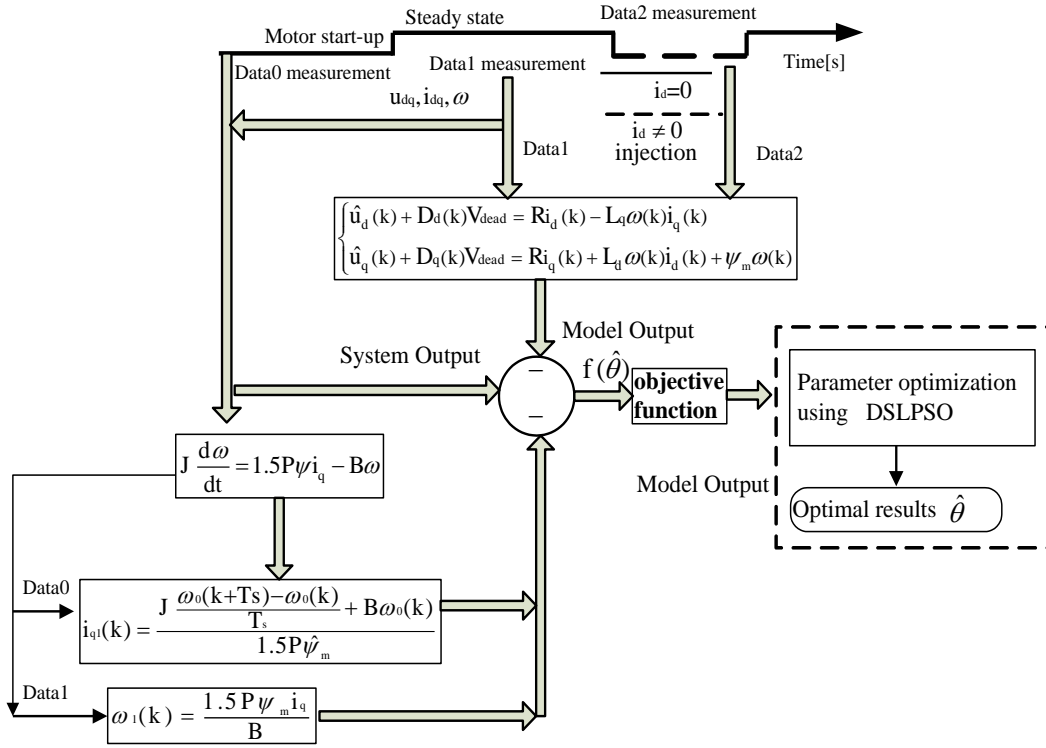

Fig .1. A schematic diagram of estimation and mathematical model

(a) Electrical Parameters Estimator Design with Considering VSI Nonlinearity

The estimation of electrical parameters combined with VSI distorted voltage can be achieved by designing a full rank reference identification model using d-axis a current injection method. Equation (6) will be used to solve the rank deficient identification problem by considering two conditions, $i_d=0$ and $i_d \neq 0$. If i_d is set to be zero (i.e., $i_d=0$) for decoupling the flux and torque control, it is ready to get (8a) and (8b) in below. A very short period of negative current (i.e. $i_d < 0$) is then injected to obtain two state equations given by (8c) and (8d). It should be noted that when a very small amount of current is injected into the motor and stopped in a very short time, the variation in the distorted voltage V_{dead} is not significant and it is assumed to be constant. At the same time, the variation of the d-axis current does not affect the q-axis current, and the rotor speed can be assumed to be constant for a surface-mounted PMSM when a short period current is injected into machine, that is $i_{q0}=i_{q1}$, $\omega_0 = \omega_1$. From this analysis, an additional equation Δu_q^* can be obtained as (8e) by subtracting the q-axis equation of (8d) from that of (8b). The symbols denoted with “0” or “1” in their subscripts indicate that the d axis is injected with the current $i_d=0$ or $i_d \neq 0$, respectively (see Fig. 1). The full rank reference model of electromagnetic parameters is given as

$$u_{d0}^*(k) = -L_q \omega_0(k) i_{q0}(k) - D_{d0}(k) V_{dead} \quad (8a)$$

$$u_{q0}^*(k) = R_{i_{q0}}(k) + \psi_m \omega_0(k) - D_{q0}(k) V_{dead} \quad (8b)$$

$$u_{d1}^*(k) = R_{i_{d1}}(k) - L_{q1} \omega_1(k) i_{q1}(k) - D_{d0}(k) V_{dead} \quad (8c)$$

$$\mathbf{u}_{q1}^*(k) = \mathbf{R}\mathbf{i}_{q1}(k) + \mathbf{L}_d\omega(k)\mathbf{i}_{d1}(k) + \psi_m\omega(k) - \mathbf{D}_{q1}(k)\mathbf{V}_{dead} \quad (8d)$$

$$\Delta\mathbf{u}_q^*(k) = \mathbf{u}_{q1}^*(k) - \mathbf{u}_{q0}^*(k) = \mathbf{L}_d\omega(k)\mathbf{i}_{d1}(k) - \mathbf{V}_{dead}(\mathbf{D}_{q1}(k) - \mathbf{D}_{q0}(k)) \quad (8e)$$

(b) Mechanical Parameters Estimator Design

The estimation of mechanical parameters can be achieved by designing an identification model using steady state condition and start-up accelerations condition.

The steady state estimation of B, with $\frac{d\omega}{dt} = 0$, (1d) can be simplified as

$$1.5P\psi_m\mathbf{i}_q = \mathbf{B}\omega \quad (9)$$

Note that when $\frac{d\omega}{dt} = 0$, the J term does not appear in this equation. In order to obtain the term J and achieve $\frac{d\omega}{dt} \neq 0$, the

motor is required to operate at constant accelerations for a period of time on start-up test, and (7) can be discretized as follow:

$$\mathbf{J} \frac{\omega(k+T_s) - \omega(k)}{T_s} = 1.5P\psi_m\mathbf{i}_q(k) - \mathbf{B}\omega(k) \quad (10)$$

where T_s is a sampling time.

C. Objective Function Design

The parameter identification can be addressed as an optimization problem where the system response to a known input is used to find the unknown parameter values of a model. The main idea of an optimization-based approach is to search the best parameters, which minimize a cost function between the measurement samples and model outputs. In this study, the seven fitness functions are generated from equation (8)-(10), and defined as follows.

$$f_1(\hat{\mathbf{L}}_q, \hat{\mathbf{V}}_{dead}) = \frac{1}{n} \sum_{k=1}^n \left| \mathbf{u}_{d0}^*(k) + \mathbf{D}_{d0}(k)\hat{\mathbf{V}}_{dead} - \hat{\mathbf{u}}_{d0}(k) \right| \quad (11)$$

$$f_2(\hat{\mathbf{R}}, \hat{\psi}, \hat{\mathbf{V}}_{dead}) = \frac{1}{n} \sum_{k=1}^n \left| \mathbf{u}_{q0}^*(k) + \mathbf{D}_{q0}(k)\hat{\mathbf{V}}_{dead} - \hat{\mathbf{u}}_{q0}(k) \right| \quad (12)$$

$$f_3(\hat{\mathbf{R}}, \hat{\mathbf{L}}_q, \hat{\mathbf{V}}_{dead}) = \frac{1}{n} \sum_{k=1}^n \left| \mathbf{u}_{d1}^*(k) + \mathbf{D}_{d1}(k)\hat{\mathbf{V}}_{dead} - \hat{\mathbf{u}}_{d1}(k) \right| \quad (13)$$

$$f_4(\hat{\mathbf{R}}, \hat{\psi}, \hat{\mathbf{L}}_q, \mathbf{V}_{dead1}) = \frac{1}{n} \sum_{k=1}^n \left| \mathbf{u}_{q1}^*(k) + \mathbf{D}_{q1}(k)\hat{\mathbf{V}}_{dead} - \hat{\mathbf{u}}_{q1}(k) \right| \quad (14)$$

$$f_5(\hat{\mathbf{L}}_q, \mathbf{V}_{dead}) = \frac{1}{n} \sum_{k=1}^n \left| \Delta\mathbf{u}_q^*(k) - \hat{\mathbf{L}}_q\omega(k)\mathbf{i}_{d1}(k) + \hat{\mathbf{V}}_{dead}(\mathbf{D}_{q1}(k) - \mathbf{D}_{q0}(k)) \right| \quad (15)$$

$$f_6(\hat{\psi}, \hat{\mathbf{B}}) = \frac{1}{n} \sum_{k=1}^n \left| \omega^*(k) - \hat{\omega}(k) \right| = \frac{1}{n} \sum_{k=1}^n \left| \omega^*(k) - \frac{1.5p\hat{\psi}\mathbf{i}_q}{\hat{\mathbf{B}}} \right| \quad (16)$$

$$f_7(\hat{\mathbf{J}}, \hat{\mathbf{B}}, \hat{\psi}) = \frac{1}{M} \sum_{k=1}^m \left| \mathbf{i}_q^*(k) - \hat{\mathbf{i}}_q(k) \right| \quad (17)$$

$$= \frac{1}{m} \sum_{k=1}^m \left| \mathbf{i}_q^*(k) - \frac{\hat{\mathbf{J}} \frac{\omega(k+T_s) - \omega(k)}{T_s} + \hat{\mathbf{B}}\omega(k)}{1.5p\hat{\psi}} \right|$$

where n is the number of samples under stable state in machine, m is the number of samples under acceleration state in machine, $\hat{\mathbf{u}}_d$, $\hat{\mathbf{u}}_q$ and $\Delta\hat{\mathbf{u}}_q$ indicate the estimated voltages in dq-axis computed by the measured currents and the estimated

parameters.

Let $\hat{\theta} = (\hat{R}, \hat{L}_d, \hat{L}_q, \hat{\psi}, V_{dead}, \hat{B}, \hat{J})$, then all the needed parameters can be identified simultaneously by minimizing the following objective function

$$f(\hat{\theta}) = \sum_{i=1}^7 a_i f_i \quad (18)$$

where a_i 's are weighting coefficients. Note that the designed objective function (18) is related to the actual PMSM drive system which is highly nonlinear, time varying and immeasurable error, with many local minimum points; all these make the parameter estimation process even more challenging. So, it is important to develop an efficient global parameter estimator for tracking the PMSM electrical and mechanical parameters combined VSI nonlinearity.

III. ESTIMATOR PARAMETER OPTIMIZATION WITH DSLPSO

A biological inspired PSO, combined with a learning mechanism, can be employed to approximate all the parameters of PMSM drive, since biological heuristic has the intrinsic ability to automatically track the dynamic objective, details of which are given below.

A. Principle of the Basic PSO Algorithm

In a d-dimensional space, each particle i has two vectors, namely the velocity vector V_i and the position vector X_i , the searching scheme can be expressed as

$$V_{id}(t+1) = \phi V_{id} + c_1 * rand_1(Pbest_{id}(t) - X_{id}(t)) + c_2 * rand_2(gBest_d(t) - X_{id}(t)) \quad (19)$$

$$X_{id}(t+1) = X_{id}(t) + V_{id}(t+1) \quad (20)$$

where ϕ is the inertia weight factor, c_1 and c_2 are the acceleration coefficients, $rand_1$ and $rand_2$ are two uniformly distributed numbers within [0,1]. The i -th particle has found best position so far is called Pbest, the best position found among the entire population is called gBest

B The Proposed Dynamic Self-Learning PSO Model

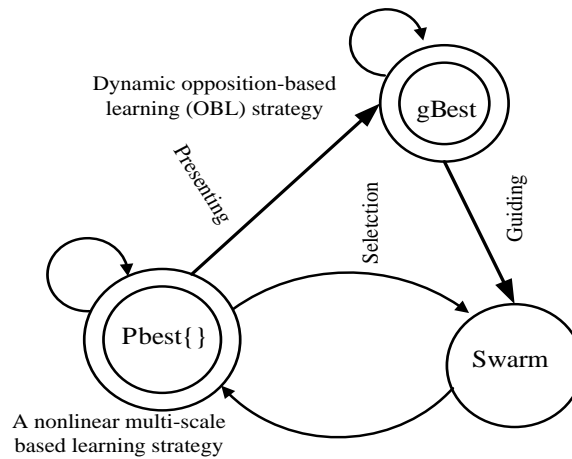

Fig.2. An illustration of dynamic self-learning PSO

So far, most PSO algorithms use a single learning pattern for all particles, which means that all particles in a swarm use the same learning strategy, that is, the particle learning its self historical search information and global search information. This monotonic

learning pattern lacks diversity for particles and is unable to deal with dynamic time-varying problem. In order to effectively solve this problem, particles with dynamic self-learning ability is needed.

The proposed DSLPSO algorithm model is shown in Fig.2, which involves two key strategies.

- 1) Firstly, a novel movement update equation with a dynamic exemplar learning pattern is designed for updating particles; this enables each swarm to learn from its Pbest particle or neighbor Pbest historical best information.
- 2) Secondly, a nonlinear multi-scale based interactive learning operator is introduced for accelerating the convergence speed of the Pbest particles and a dynamic opposition-based learning (OBL) strategy is designed to facilitate the gBest particle to explore a potentially better region.

The general steps of DSLPSO for PMSM parameter estimation are stated as follows.

Algorithm: DSLPSO algorithm for PMSM parameter estimation

Step1: Initialize parameters, data sampling and recording as in Fig 1.

Step2: Load data (Data0, Data1 and Data2 are as in Fig.1) are used to drive the estimator model.

Step3: for $i=1$ to N // $1 \leq i \leq N$, N is the number of particles
 update particle _{i} velocity (V_i) using the dynamic exemplar learning pattern as in equation (21)
 update particle _{i} position (X_i) as in equation(22) }

Evaluate the fitness value (Fit(X_i))of particle _{i} ;

IF Fit(X_i) < Fit(Pbest _{i}) then Update Pbest _{i} (Pbest _{i} ← X_i)

IF Fit(Pbest _{i}) < Fit(gBest) Then Update gBest (gBest ← Pbest _{i})

End for

Step4: for $i=1$ to K // $1 \leq i \leq K$, K is the number of Pbest

A multi-scale based interactive learning scheme for Pbest _{i} using the equations (24)-(25).

Evaluate the fitness value (Fit(X_i))of NpBest _{i} (New PBest _{i})

Update Pbest _{i} (Pbest _{i} ← Pbest _{i} ∪ NpBest _{i})

End for

Step5: A dynamic OBL strategy for gBest particle by using the equations (26)-(29).

Until a terminate condition is met, or else, returns to step2.

Step6: Output optimal results (R , L_d , L_q , ψ_m , V_{dead} , B , J).

C. Dynamic Exemplar Learning Pattern for PSO

In this study, a novel movement update equation is designed for updating particles by investigating a dynamic exemplar learning pattern. This enables each swarm to learn from its historical optimal information or neighbor optimal information, that is, the velocity updating equation indicates that all of exploitation particles' historical best information is used to update a particle's velocity, the good searched information can be exchanged among all particles. This makes a balance between extensive searching and accurate searching. The proposed dynamic PSO model is

$$V_{id}(t+1) = \phi V_{id} + c_1 * \text{rand}_1() (P_{\text{best}_{(p_i)d}}(t) - X_{id}(t)) + c_2 * \text{rand}_2() (g\text{Best}_d(t) - X_{id}(t)) \quad (21)$$

$$X_{id}(t+1) = X_{id}(t) + V_{id}(t+1) \quad (22)$$

where $P_{\text{best}_{p_i}} = [P_{\text{best}_1}, P_{\text{best}_2}, \dots, P_{\text{best}_N}]$, p_i means that the p_i -th P_{best} provides the best information, and the other particles should learn from it, which determined by the learning probability P_{c_i} is given as

$$P_{c_i} = 0.1 + 0.5 \frac{1}{\sqrt{S_i}} \quad (23)$$

where S_i represents the ranking number of the i th particle in all particles according to fitness value (from small to large). If $\text{random} > P_{c_i}$, then $p_i \leftarrow i$, meaning that the i -th particle learns from itself P_{best} ; otherwise $p_i \leftarrow (i + C * \text{rand}) \% N$ (N is the number of population), where C is the range of a neighborhood, meaning that the i -th particle learns from the neighbor's historical best information.

D. A Multi-scale based Interactive Learning Scheme for Pbests

Inspired by a common social learning behavior, an interactive learning strategy is proposed to enable P_{best} particles to learn the good experience from each other and exchange their best search information among the elite swarm during the search process. This interactive learning strategy can maintain the diversity of the swarm and boost fast convergence speed. A nonlinear multi-scale based learning strategy for P_{best} is given as

$$NP_{\text{best}_{id}}(t+1) = P_{\text{best}_{id}}(t) + \eta(t) * (P_{\text{best}_{\varphi[d]}}(t) - P_{\text{best}_{id}}(t)) \quad (24)$$

$$\eta(t) = e^{-\lambda u} \cdot \cos(2\pi u) \cdot (1 - \frac{t}{T}) \quad (25)$$

where T is the maximum evolution generation and t is the current generation number, the symbol φ is the randomly selected the exploitation population and $\varphi = \lfloor \text{rand} * K \rfloor$. $\eta(t)$ is a nonlinear multi-scale mutation operator, the nonlinear variation coefficient λ is a formal parameter and is set to be 2, u is randomly generated during the initialization and in each generation, respectively, which are both uniformly distributed in $(0, 1)$. Note that the definition of (25) is useful in the earlier evolution, the large-scale mutation operators can be utilized to quickly locate the global optimal space; on the later evolution, the small-scale mutation operators can be used to implement the accuracy of the solution at the late evolution with the increasing number of generations. The multi-scale based interactive learning scheme can therefore enable P_{best} particles to jump out a local optimum and obtain an overall robust search performance.

E. A Dynamic OBL strategy for gBest

The gBest particles are usually used as the exemplars to lead the flying direction of all particles. If the global best particle does not find a better position, it will then easily lead to other particles “stuck in” a local optimum. It needs a reinforcement learning mechanism to improve the gBest search performance. The opposition-based learning (OBL) is a machine learning method and was firstly proposed by Tizhoosh [38]. The basic idea of OBL is that a search in the opposite direction is carried out simultaneously when a solution is exploited in a direction, i.e.,

$$\tilde{x} = a + b - x \quad (26)$$

where x is a real number on the interval $[a, b]$, and \tilde{x} is the opposite number of x . This definition is also valid for D-dimensional space, where for $x_1, x_2, \dots, x_D \in \mathbb{R}$ and $x_i \in [a_i, b_i]$, the D-dimensional point x_i is defined as

$$x_i = a_i + b_i - x \quad (27)$$

However, the exploration performance of deterministic OBL is limited. In order to overcome the drawbacks of the original OBL and enhance the gBest particle convergence speed, a dynamic OBL strategy using adaptive Gaussian distribution is designed as

$$\begin{aligned} \text{ogBest}_d &= \text{Gaussian}(\mu, \sigma^2)(a_d(t) + b_d(t)) - \text{gBest}_d \quad (28) \\ a_d(t) &= \min(\text{gBest}_d), b_d(t) = \max(\text{gBest}_d) \end{aligned}$$

where $\text{Gaussian}(\mu, \sigma^2)$ is a random number of a Gaussian distribution with a zero mean (μ) and a standard deviation (σ). In order to obtain a better dynamic learning performance for gBest, it is assumed that σ decreases linearly, for which a good choice may be given as

$$\sigma = \sigma_{\min} + (\sigma_{\max} - \sigma_{\min}) \left(1 - \frac{t}{T}\right) \quad (29)$$

where σ_{\max} and σ_{\min} are the upper and lower bounds of σ , which specifies the learning scale to reach a new region (in practice, σ could be bounded between 0 and 1). This strategy provides a disturbance at gBest, the jump out performance is enhanced by this improved OBL with dynamic Gaussian distribution which is beneficial to guide global particles' moving direction and enhance convergence speed.

IV. EXPERIMENTAL RESULTS AND ANALYSIS

A. Hardware Control System and Software Platform

The control system and software platform is presented in Fig.3(a) and the associated parameter estimation system is displayed in Fig.3(b), which is designed based on a prototype PMSM (a conventional vector control system). The details of the PMSM are given in Table I. The waveforms of measured dq-axis currents/voltages and mechanical angular speeds of PMSM (i.e., normal temperature condition) are shown in Fig.4; In this study, all the signals required for the machine parameter estimation are recorded by

a PC, and no other additional signal measurement equipment is needed. The current signal is measured from the three-phase current sensor (placed in the drive), the voltage signal is measured from the Bus voltage sensor (placed in the drive), and the position signal is measured from incremental encoder (placed in the rotor) and can be used for velocity calculation.

The sampling period is set $83.3 \mu s$, and this study uses 1000 measurements for parameter estimator. Three datasets are collected : 1) the first dataset is for motor start and accelerated measurements (Data0); 2) the second dataset contains the $i_d=0$ control steady state measurements (Data1), and 3) the third dataset (Data2) contains measurements when d-axis reference currents are injected into the drive system after at steady state , as indicated in Fig.1. The parameter estimation process is divided into two main stages: the experimental data acquisition and data processing. The proposed method can be applied to estimate system parameters of a PMSM based large equipment such as railway transportation and wind power generation system. For a large-scale engineering application, there would be a large amount of operating condition data and control signals to process, so it may need a large amount of computation and data storage, for such a case the processing of parameter estimation can still be done in a PC. With the development of high-performance computer, the work can be done by collaborative PC with inverter controller .The high computational task and massive storage can be done by PC and the results can be sent to inverter controller for system controller design and operating status judgment.

For comparison, a series of hybrid PSOs are used, including HPSOM (hybrid PSO with mutation) [39], HGAPSO (hybrid PSO with genetic algorithm) [40], HPSOWM (hybrid PSO with Wavelet Mutation) [41], CLPSO (comprehensive learning PSO) [42], OPSO (An opposition-based learning for PSO) [38] and APSO (adaptive Particle Swarm Optimization) [43]. To assess the performance of parameter estimation, a statistical analysis is performed in terms of the mean results, standard deviation and the t-test value. The basic settings of these PSOs are as follows: the maximum iteration is 300 and the number of runs is 10. With the consideration of precision and time-consuming, the variable bounds should be to set an appropriate width, not too wide, not too narrow. The search bounds are to be specified as: $R \in (0,0.64)\Omega$, L_d and $L_q \in (0,5.12)mH$, $\psi_m \in (0,100) mWb$, $V_{dead} \in (-1,0)V$, $B \in (0.0001,1) N.m/rad/s$,and $J \in (0.00000001,0.1) Kg.m^2$. For fair comparison, all test methods are operated on the same platform with the same objective function, search variable bounds, measured data, and PMSM hardware. All experiments are carried out on the same computer with AMD Athlon(tm) II X4 555, four-core processors, RAM 4.0GB.

TABLE I .
DESIGN PARAMETERS AND SPECIFICATION OF PMSM

Rated speed	400rpm
Rated current	4A
DC link voltage	36V
Nominal terminal wire resistance	0.043
Nominal self inductance	2.91mH
Nominal mutual inductance	-0.330mH
Nominal d-axis inductance	3.24mH
Nominal q-axis inductance	3.24mH
Nominal amplitude of flux induced by magnets	77.6 mWb
Number of pole pairs	5
Nominal phase resistance (T=25 °C)	0.330 Ω
Inertia	$8e-5Kg.m^2$



(a) Photograph of the experimental system with prototype PMSM
 Fig. 3. The schematic diagram of identification hardware and software platform.

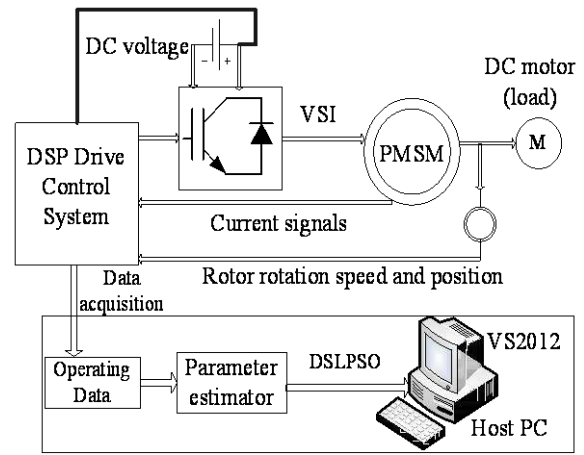

(b) The proposed parameter estimation system

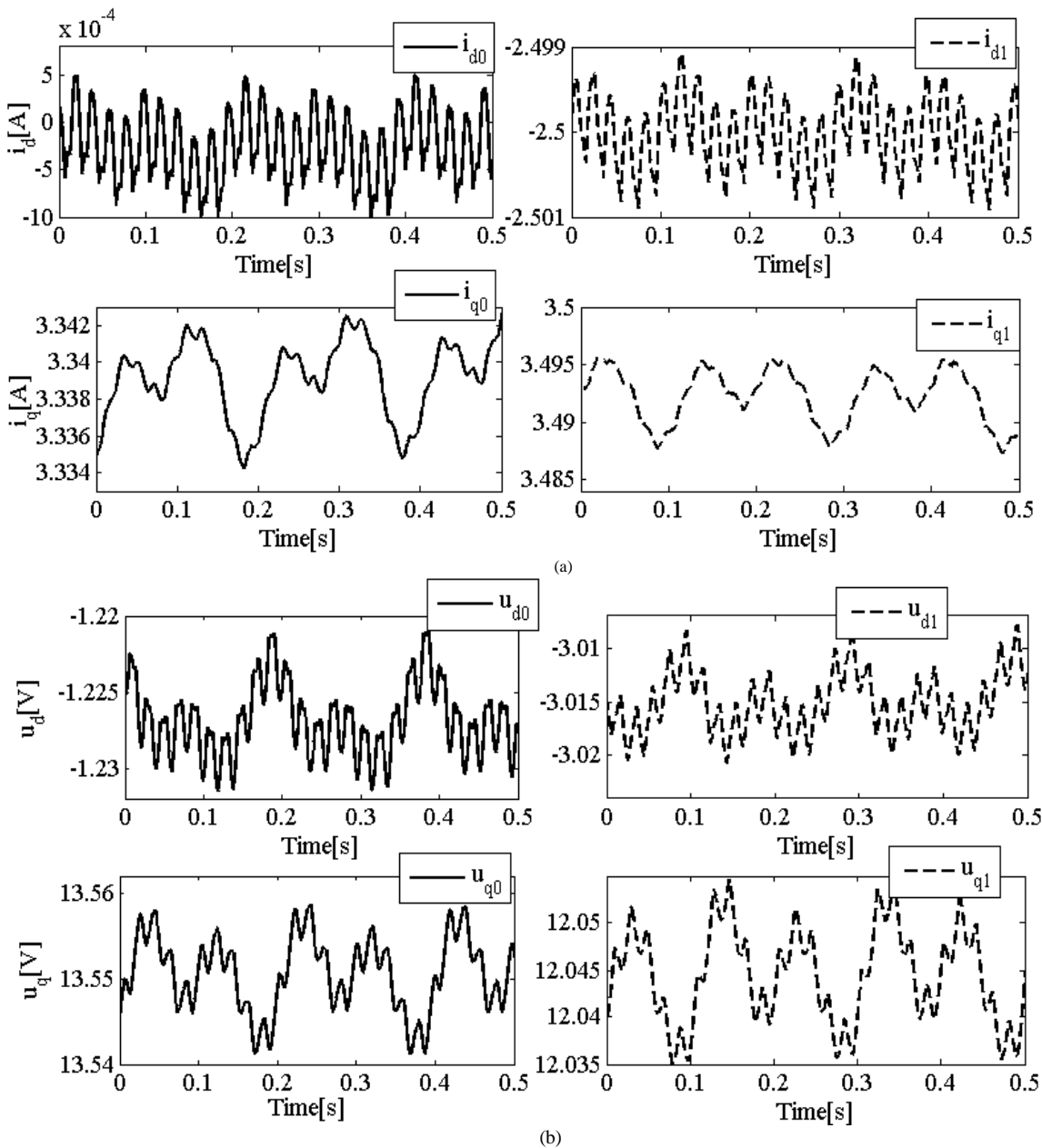

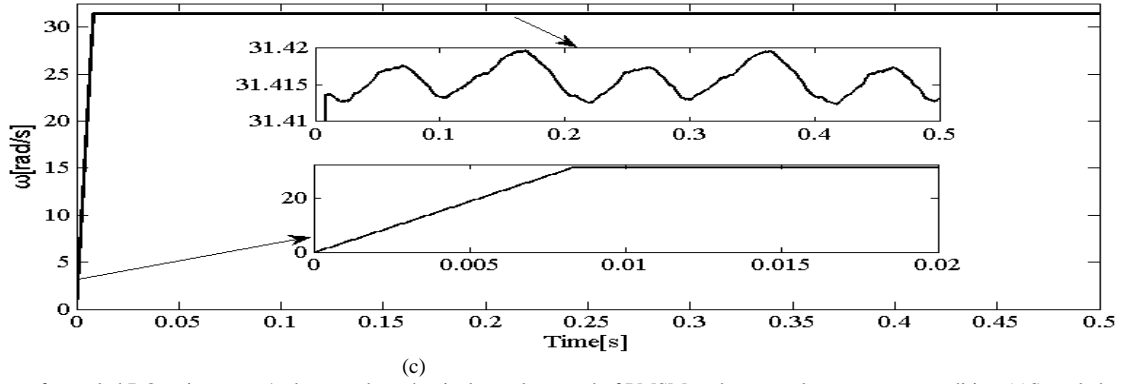

Fig.4. Waveforms of sampled DQ-axis current/voltage and mechanical angular speed of PMSM under normal temperature condition. (a) Sampled of d-q axis current of PMSM. (b) Sampled of d-q axis voltage of PMSM. (c) Sampled of mechanical angular speed of PMSM.

B. Parameter Estimation under Normal Temperature Condition

Table II presents the parameter estimated value, mean fitness, standard deviations, t-values and time cost values measured with each method using data measured from normal temperature environment. The convergences of different PSOs are shown in Fig.5(a). All the parameter estimation results (including electrical parameters and mechanical parameters) are plotted in Fig.6. It is clear that the proposed DSLPSO shows the best performances in terms of mean fitness, standard deviations and t-values among those seven methods. As we all known, the smaller mean fitness and smaller standard deviation, the more stable of algorithm, from the results of the Table II, Table III and Table IV, we can see that the proposed DSLPSO achieved the smallest mean and standard deviation, it proves that the DSLPSO has the best stability among these peer algorithms. As can be seen from Fig.5 (a), DSLPSO can converge to the optimum after about 150 generations of evolution while other hybrid PSOs shows relative poor convergence performance. Furthermore, all the t-values are higher than 6, which imply that the proposed DSLPSO has significantly better solution performance than other hybrid PSOs (the confidence level is 98%).

Moreover, as shown in Table II, the running time for HPSOM, HGAPSO, HPSOWM, CLPSO, OPSO and APSO are 145.24s, 91.94s, 147.51s, 72.04s, 163.51s and 7.50s, respectively. However, the computation time of DSLPSO is only 6.58 s, which is smaller than all the comparative PSO methods. Similar results can be observed in Table III and Table IV. All this demonstrates that the proposed DSLPSO has a quick search speed and does not increase time complexity in comparison with the basic PSO.

As demonstrated in Table II, the estimated winding resistance (0.372Ω) by DSLPSO is very close to the measured value (0.373Ω , which is nominally 0.33Ω (phase resistance), together with 0.043Ω (terminal wire resistance)) under normal temperature. In addition, the estimated flux linkage ψ_m (78.07mWb) by DSLPSO is quite close to its nominal value (77.6mWb), the estimated d-axis inductance (3.138mH) and q-axis inductance (3.683mH) also agree well with the nominal value on manual. The slight difference between the estimated and nominal values of machine parameters may be caused by nonlinearity relating to the working condition. Fig. 11 shows the estimated moment of inertia of rotor and the viscous friction coefficient, from which it

is obvious that the estimated moment of inertia of PMSM rotor ($7.36 \times 10^{-5} \text{ kg.m}^2$) is quite close to its nominal value ($8 \times 10^{-5} \text{ kg.m}^2$).

As shown in Fig.7(a), the value of VSI disturbance voltage V_{dead} can be estimated simultaneously with other machine parameters based on the proposed estimator model. Furthermore, the VSI nonlinearity compensation can be simultaneously obtained by computing $Dd.V_{\text{dead}}$ and adding the value of $Dq.V_{\text{dead}}$ to the output of dq-axis PI regulators. The obtained V_{dead} values can be fed back to the control system of PMSM. For example, the compensation on V_{dead} slowly increases until V_{dead} approaches zero, and this can help reduce its influence on system stability.

It can be observed from Table II and Fig. 5 that the proposed DSLPSO is of high precision for estimating the electrical parameters and estimating the immeasurable mechanical parameters, along with the VSI disturbance voltage simultaneously. There are some reasons behind these observations that the proposed estimator has global convergence performance. Firstly, a dynamic learning estimator is proposed for tracking the electrical parameters, mechanical parameters and VSI of PMSM drive by using a dynamic self-learning particle swarm optimization. Secondly, a novel movement modification equation with dynamic exemplar learning strategy is designed to ensure its diversity and the balance between exploitation and exploration during the search process. Thirdly, a nonlinear multi-scale based learning operator is introduced for accelerating the convergence speed of the Pbest particles, and a dynamic opposition-based learning (OBL) strategy is designed to facilitate the gBest particle to explore a potentially better region.

TABLE II.
RESULT COMPARISONS AMONG SEVEN PSOS ON PMSM PARAMETER IDENTIFICATION WITH NORMAL TEMPERATURE

Estimated Parameters	HPSOM	HGAPSO	HPSOWM	CLPSO	OPSO	APSO	DSLPSO	
$R(\Omega)$	0.309	0.328	0.359	0.317	0.302	0.357	0.372	
$\psi_m(\text{mWb})$	80.05	80.39	78.75	79.32	80.26	80.64	78.07	
$L_d(\text{mH})$	3.14	3.107	3.405	3.327	2.724	3.140	3.138	
$L_q(\text{mH})$	3.85	4.118	3.806	3.692	4.137	3.918	3.683	
$V_{\text{dead}}(\text{V})$	-0.294	-0.088	-0.352	-0.204	-0.0695	-0.149	-0.065	
$B(\text{N.m/rad/s})$	0.064	0.064	0.063	0.063	0.065	0.065	0.062	
$J(\text{Kg.m}^2)$	8.09e-5	5.28e-5	7.13e-5	8.81e-5	6.58e-5	5.42e-5	7.36e-5	
Fitness	Mean	1.595	1.641	1.699	3.134	1.851	3.194	1.25
	Std.dev	0.155	0.295	0.122	0.665	0.225	0.932	0.012
	t-value	12.85	8.79	19.36	19.77	16.98	14.65	0
	Time	145.24	91.94	147.51	72.04	163.51	7.50	6.58

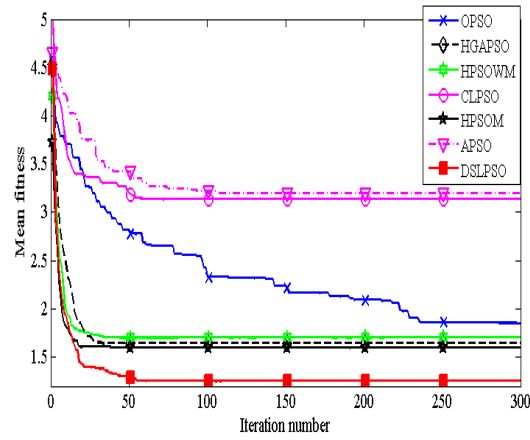

(a)

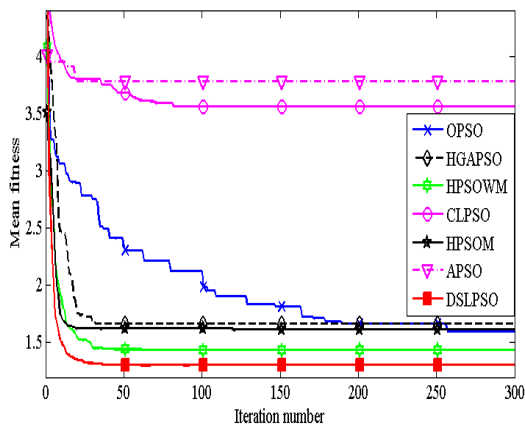

(b)

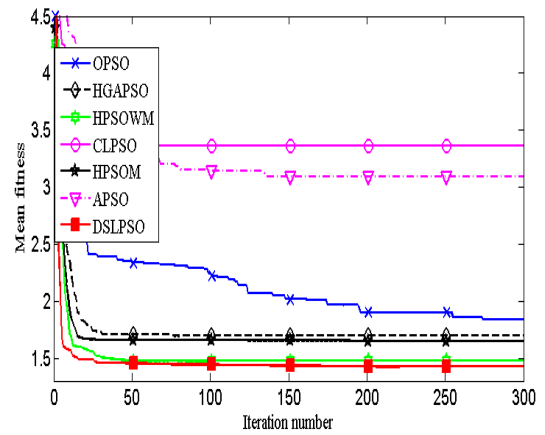

(c)

Fig. 5. The fitness convergence curve of seven PSOs on PMSM all parameter estimation(a) under normal temperature. (b)with heating 20 min. (c) with heating 20 min and cooling 9min.

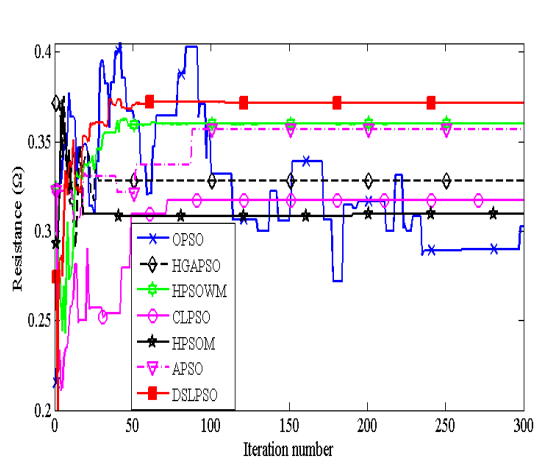

(a)

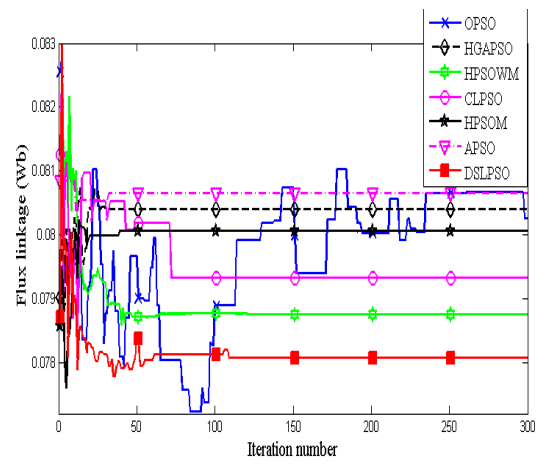

(b)

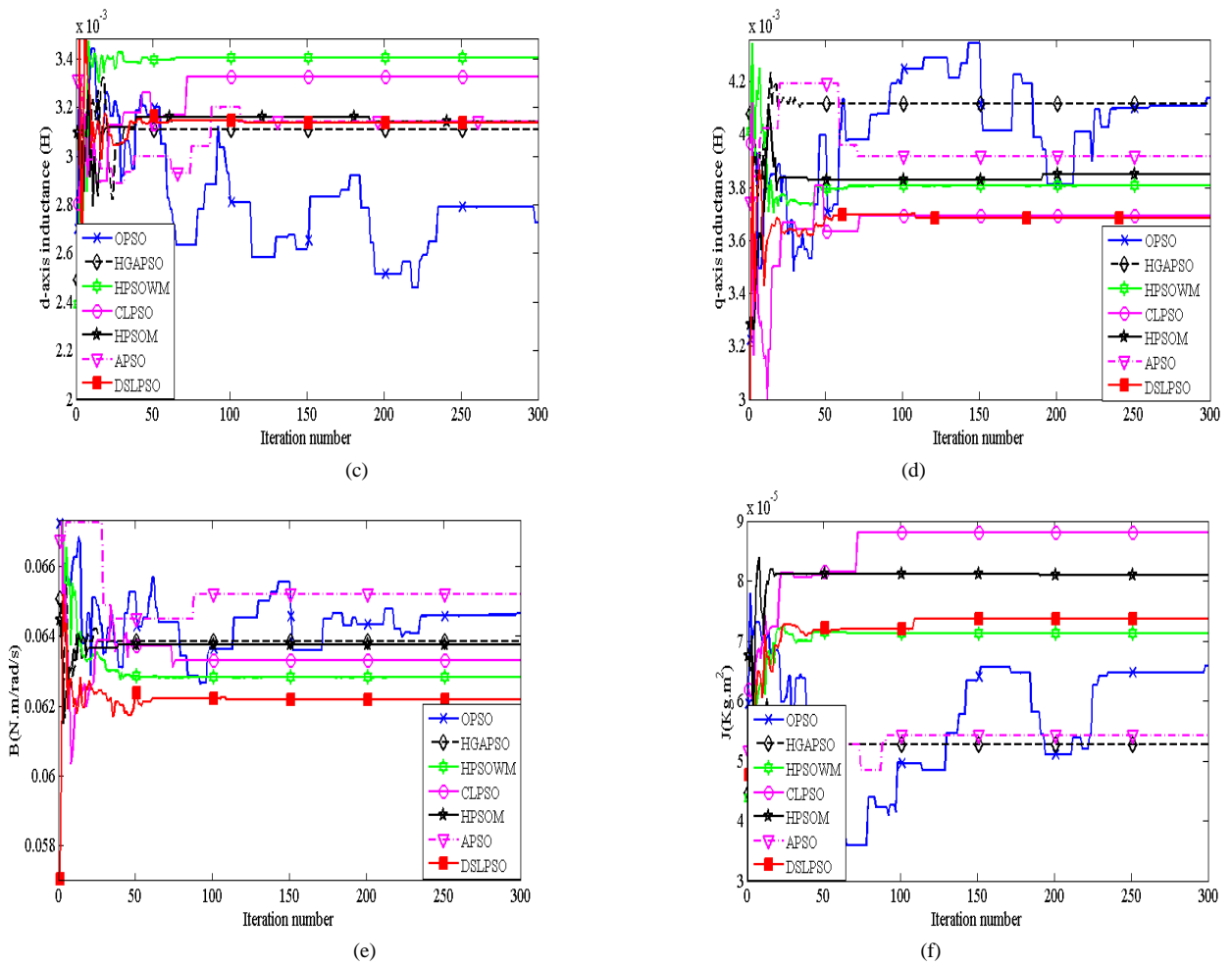
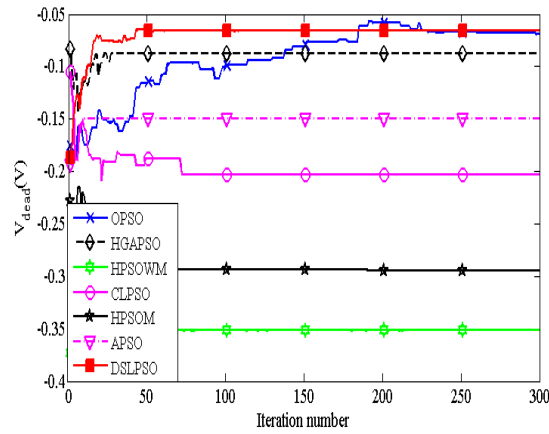

Fig. 6. Parameter estimates under normal temperature condition (a) winding resistance. (b) rotor flux linkage (c) d-axis inductance.(d) q-axis inductance.(e) viscous friction coefficient.(f) moment of inertia.



(a)

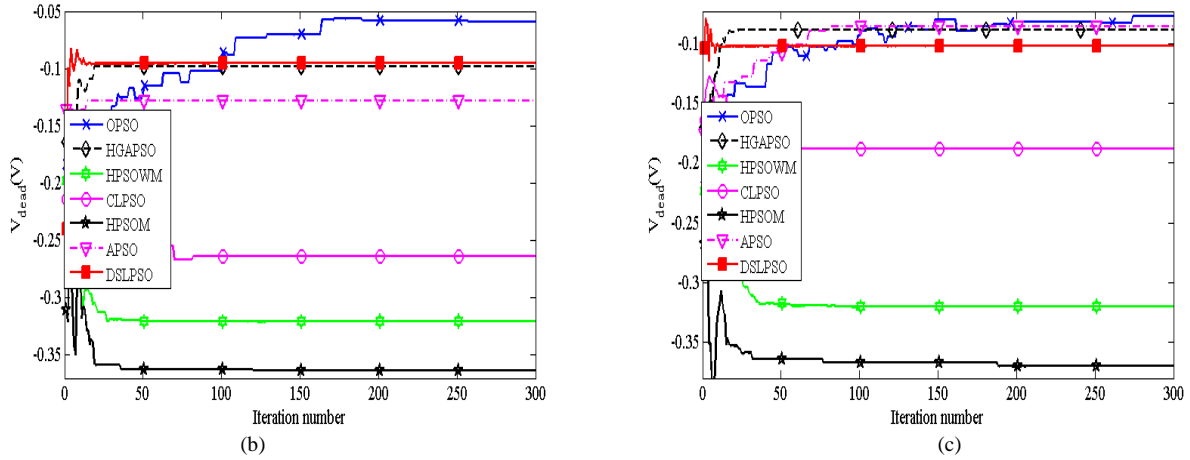

Fig.7. Estimated V_{dead} . (a) under normal temperature.(b) with heating 20 min. (c) with heating 20 min and cooling 9min.

B. Parameter Estimation under Temperature Variation Condition

It is well known that the parameters of PMSM change with the variation of operating conditions: temperature, frequency, and the saturation level of the machine. In order to validate the performance of the proposed method for tracking the variation of parameters under operation condition with varying temperature, in this study experiments on some varying temperature conditions are carried out. The experiments on temperature variation are divided into two steps.

- Continuously heating the PMSM for 20 minutes and recording experimental data ,then estimating all the electrical parameters ,mechanical parameters and VSI distort voltage (time=20 minutes).
- After the removal of the heater at time=20 minutes, and cooling 9 minutes, then estimating all the electrical parameters ,mechanical parameters and VSI distort voltage (time=29 minutes).

The estimated PMSM parameters and VSI distort voltage using different PSOs for the above case (a) (i.e., continuously heating 20 minutes) are depicted in Table III, Fig.5 (b), Fig.7 (b) and Fig.8, whereas the results for case (b) (i.e. continuously heating 20 minutes and then cooling 9 minutes) are depicted in Table IV, Fig.5(c) , Fig.7(c) and Fig.9. From Table III, Table IV, and Fig.7(b)-(c), it is clear that the DSLPSO outperforms other hybrid PSOs in terms of mean, standard deviation and t-test values when estimating the electrical parameters, mechanical parameters and VSI distort voltage of PMSM drive under varying temperature conditions.

The results show that the estimated winding resistance R , d-axis inductance (L_d), q-axis inductance (L_q) and rotor flux linkage (ψ_m) vary with the changing temperature. For example, the estimated winding resistance value increases from $0.372(\Omega)$ to $0.435(\Omega)$ with heating 20 minutes in high temperature, and then it decreases to $0.417(\Omega)$ after 9 minutes cooling. The stator winding resistance value increases gradually when the temperature rises gradually and returns to normal value when temperature returns to normal, due to the effects of the thermal metal. In return, the estimated winding resistance can be used for temperature monitoring of machine as the estimated winding resistance is linear varying with the changes of temperature. The estimated rotor

flux linkage decreases from 78.07 (mWb) to 77.36 (mWb), there is an abrupt drop in the estimated rotor flux linkage after 20 minute heating, and then it increases to 77.9 (mWb) after 9 minutes cooling, which can be explained by the fact that the residual flux density and intrinsic coercivity of the PM varies with the changing of temperature, that is, it reduces when the temperature of NdFeB magnets increases and it returns to normal value if the temperature of NdFeB magnets return to normal within critical temperature. The estimated L_d and L_q also change when temperature varies (but d-axis and q-axis inductances are not affected significantly by machine temperature), the reason is that the values of L_d and L_q are mainly influenced by the flux density which may change during the data measurement.

Furthermore, from Table II, Table III and Table IV, it can be seen that the estimated VSI disturbance voltage V_{dead} varies from -0.065 (v) to -0.096(v) after 20 minute heating, and it changes to -0.102 (v) after 9 minute cooling. This phenomenon can be explained by the fact that the VSI nonlinearity is also influenced by the temperature variation. This observation can be explained that the parameters of the PMSM may deviate from its nominal value when it's operating condition changes.

Theoretically, the electrical parameters vary with the change of operation temperature, whereas the mechanical parameters viscous friction coefficient (B) and moment of inertia (J) change little with variation of operation temperature. This phenomenon indicates that the electrical parameters are sensitive to the operating conditions, whereas the mechanical parameters B and J are not sensitive to the variation of temperature conditions. This is because the mechanical parameters are mainly affected by the shape and the dimensions of mechanical loads.

These results show that the proposed parameter estimator can simultaneously track the PMSM parameters and the VSI disturbance voltage very well without requiring a priori knowledge of motor parameters and switching device parameters, it only uses electrical measurements taken at machine terminals. Especially, when the operation condition changes, the proposed method can simultaneously estimate the electrical parameters, the mechanical parameters and VSI distorted voltage with good accuracy.

TABLE III.
RESULT COMPARISONS AMONG SEVEN PSOS ON PMSM PARAMETER IDENTIFICATION UNDER TEMPERATURE VARIATION WITH HEATING 20MINUTES

Estimated Parameters	HPSOM	HGAPSO	HPSOWM	CLPSO	OPSO	APSO	DSLPSO	
R(Ω)	0.463	0.467	0.424	0.460	0.466	0.420	0.435	
ψ_m (mWb)	77.04	76.72	77.87	78.72	76.72	75.44	77.36	
L_d (mH)	3.052	3.229	3.232	3.111	2.982	3.136	3.268	
L_q (mH)	3.792	3.649	3.855	4.005	3.573	3.361	3.619	
V_{dead} (V)	-0.364	-0.098	-0.322	-0.263	-0.059	-0.129	-0.096	
B(N.m/rad/s)	0.062	0.062	0.063	0.063	0.062	0.066	0.063	
J(Kg.m ²)	6.21e-5	5.69e-5	6.44e-5	7.58e-5	5.94e-5	4.61e-5	7.77e-5	
Fitness	Mean	1.612	1.667	1.438	3.556	1.598	3.776	1.301
	Std.dev	0.189	0.412	0.229	0.621	0.397	1.134	0.052
	t-value	7.43	5.49	2.99	24.10	4.59	15.013	0
	Time	146.71	94.54	146.81	72.55	169.91	7.71	6.87

TABLE IV.
RESULT COMPARISONS AMONG SEVEN PSOS ON PMSM PARAMETER IDENTIFICATION UNDER TEMPERATURE VARIATION WITH HEATING 20MINUTES AND AFTER COOLING 9 MINUTES

Estimated Parameters	HPSOM	HGAPSO	HPSOWM	CLPSO	OPSO	APSO	DSLPSO
R(Ω)	0.429	0.383	0.419	0.429	0.393	0.403	0.417
ψ_m (mWb)	78.03	78.73	78.07	77.56	78.09	78.68	77.90
L_d (mH)	3.227	3.095	3.418	3.727	2.516	3.061	3.417

L_q (mH)	3.798	3.828	3.856	4.295	3.879	3.766	3.939	
V_{dead} (V)	-0.37	-0.088	-0.321	-0.163	-0.078	-0.0857	-0.102	
B (N.m/rad/s)	0.063	0.064	0.063	0.063	0.062	0.064	0.063	
J (Kg.m ²)	7.56e-5	5.393e-5	7.52e-5	6.86e-5	6.57e-5	3.20e-5	8.83e-5	
Fitness	mean	1.65	1.69	1.471	2.98	1.84	3.09	1.424
	Std.dev	0.203	0.399	0.176	0.760	0.167	1.876	0.024
	t-value	6.26	4.39	1.42	14.19	12.91	6.26	0
Time	147.29	92.37	148.93	72.58	166.24	7.68	6.99	

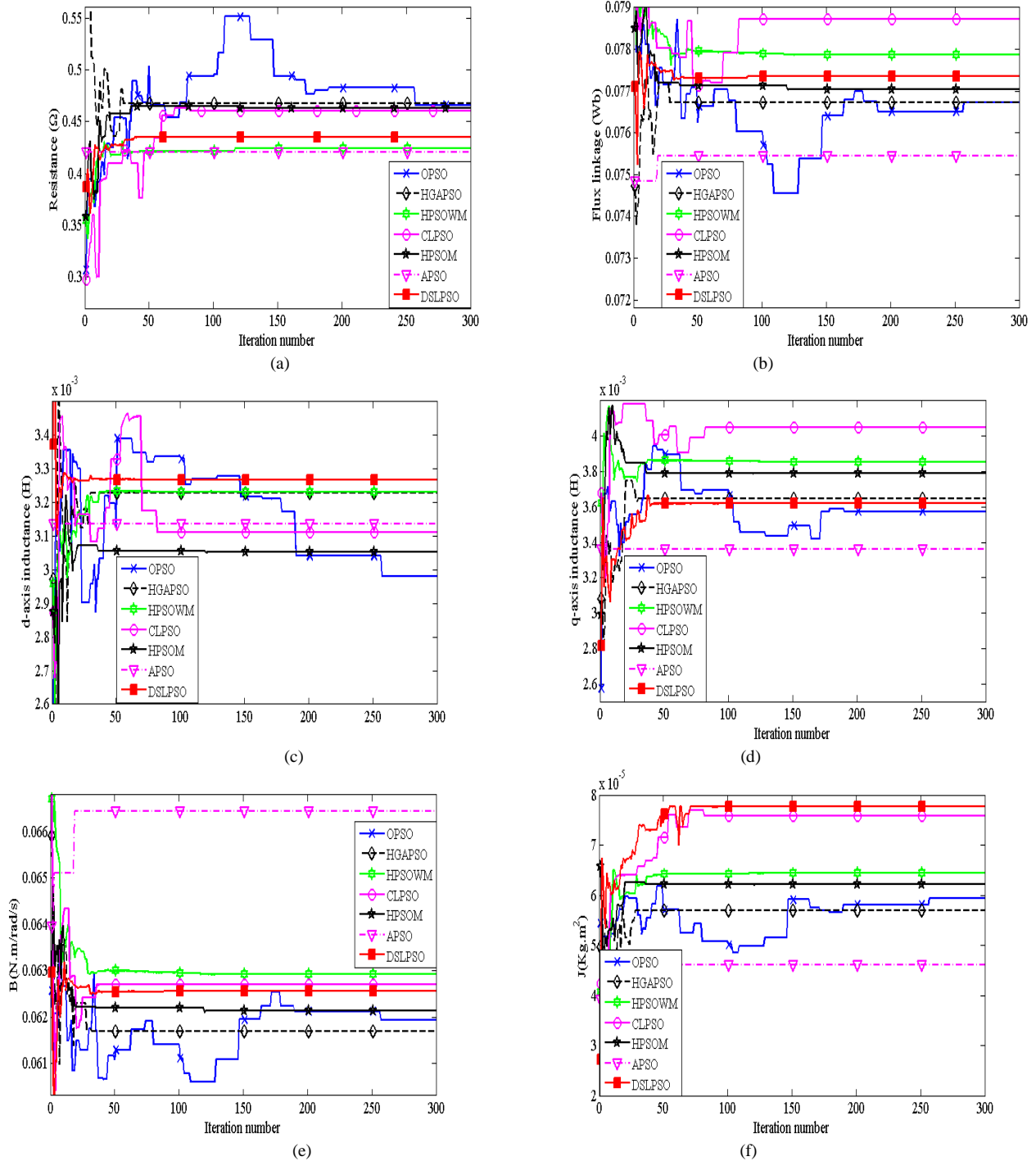

Fig. 8. Parameter estimates with heating 20 min(time=20 minutes) (a) winding resistance. (b) rotor flux linkage (c) d-axis inductance.(d) q-axis inductance. (e) viscous friction coefficient.(f) moment of inertia.

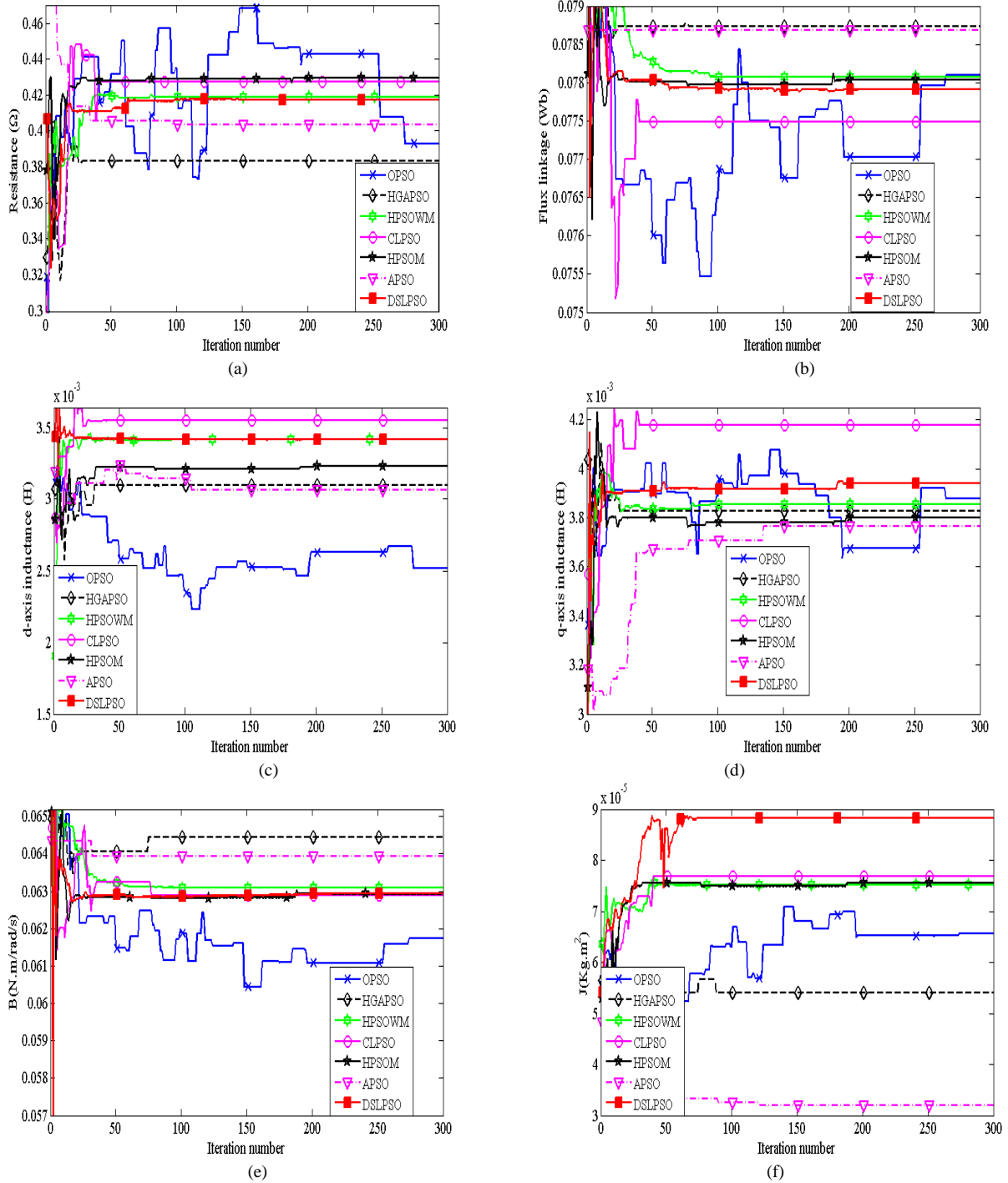

Fig. 9. Identified parameters with heating 20 min and cooling 9min (time=29 minutes) (a) winding resistance. (b) rotor flux linkage (c) d-axis inductance.(d) q-axis inductance. (e) viscous friction coefficient.(f) moment of inertia.

C. Verification of the Estimation Accuracy and the Variation Tracking Performance

To further verify the parameter estimation accuracy and the parameter tracking performance, we employ the following approach to test the effectiveness of the proposed method: a) change the winding resistance value, and b) use the LCR bridge to measure the winding resistance value. Details are described below.

a. Parameter Estimation by changing the Winding Resistance Value

A step change in winding resistance value is applied to verify the effectiveness of the proposed method. Three resistances ($R_p=0.414 \Omega$) are simultaneously connected with three-phase windings in the machine. The estimated results are shown in Fig. 10 and Table V, from which it is clear that the estimated R (0.782Ω) with adding R_p is quite close to the actual resistance (0.787Ω ($0.373 \Omega + 0.414 \Omega$)). The other estimated parameters are also quite close to the nominal parameters, for example the estimated rotor flux linkage ψ_m (77.94 mWb) is quite close to its nominal value (77.6mWb), the estimated d-axis inductance (3.115mH) and q-axis inductance (3.281mH) also agree well with the nominal values on manual. The reason can be explained that the winding resistance value is changed by adding additional resistance and the other machine parameters are not changed under the normal temperature working condition.

From equations (8)-(18), other six parameters (i.e., L_d , L_q , ψ_m , V_{dead} , B , J) can also be accurately estimated if the winding resistance is accurately estimated, as the total system parameters are simultaneously identified using the same parameter estimator model. Therefore, the proposed parameter estimation model and parameter estimation algorithm performs very well in identifying the actual machine parameter and tracking the variation of parameters.

TABLE V
COMPARISON OF ESTIMATED PARAMETERS WITH DIFFERENT WORKING CONDITION USING THE PROPOSED
DSLPSO-BASED PARAMETER ESTIMATION METHOD

Parameters	Estimated Values under Normal Temperature	Estimated Values with Adding R_p under Normal Temperature	Estimated Values/(LCR Test Values)with Heating 20Min	Estimated Values /(LCR Test Values) with Heating 20Min and Cooling 9Min
$R(\Omega)$	0.372	0.782	0.435/(0.45)	0.417/(0.41)
ψ_m (mWb)	78.07	77.94	77.36	77.90
L_d (mH)	3.138	3.115	3.268	3.417
L_q (mH)	3.683	3.281	3.619	3.939
V_{dead} (V)	-0.065	-0.0757	-0.096	-0.102
B (N.m/rad/s)	0.062	0.062	0.063	0.063
J (Kg.m ²)	7.36e-5	7.51e-5	7.77e-5	8.83e-5

b. The use of LCR bridge for measuring the winding resistance value

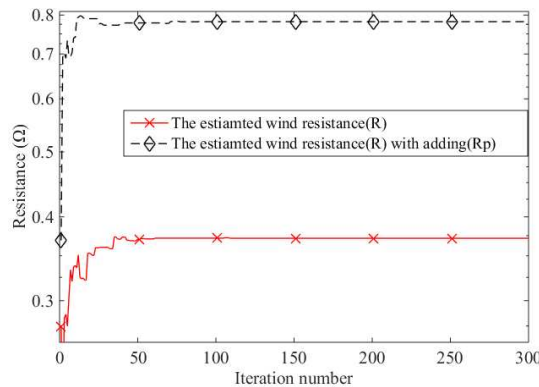
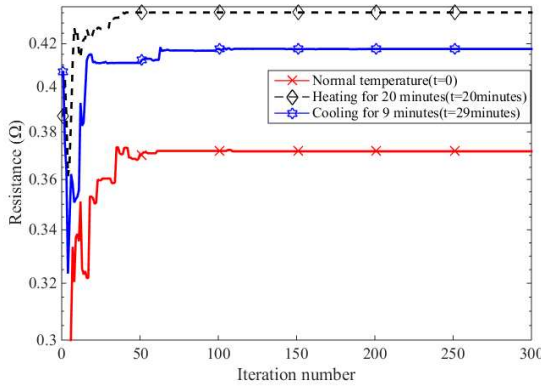
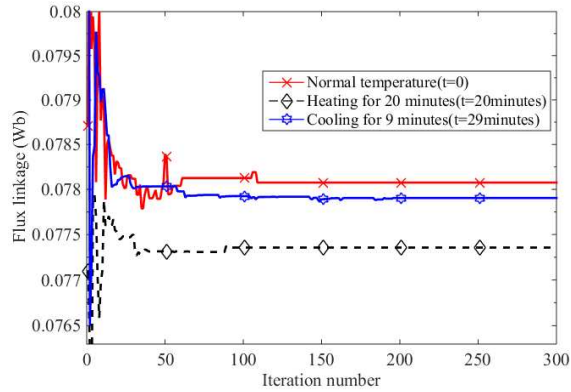

Fig.10. Estimated winding resistance with adding R_p



(a) The winding resistance varying with temperature variation



(b) The rotor flux linkage varying with temperature variation

Fig.11 Estimated parameters varying with temperature variation

A LCR bridge is used to test the value of winding resistance R (with the power source being switched off), the measured results are shown in Table V. The measured value R (0.45Ω) is very close to the estimated value (0.435Ω). Additionally, the measured value of winding resistance (0.41Ω) is also very close to the estimated value (0.417Ω) by the LCR bridge after naturally cooling 9 minutes. The slight difference between the estimated and the measured value may be caused by measurement error. Again, from equations (8)-(18), other six parameters (i.e., L_d , L_q , ψ_m , V_{dead} , B , J) can be accurately estimated as the winding resistance is accurately estimated. So, the proposed parameter estimation model works very well for tracking the variation of parameters under the variation temperature. Further, from Fig.11 and Table VI, the value of winding resistance increases with the heating temperature; on the contrary, the value of rotor flux linkage decreases with the heating temperature within critical temperature. Thus, the change of the winding resistance and rotor flux linkage can be used for condition monitoring of PMSM.

D. The Influence of VSI Nonlinearity on Parameter Estimation

In this study, an experiment with and without considering VSI nonlinearity are conducted to show that the estimation performance can be improved by considering VSI nonlinearity. Here, “without considering VSI nonlinearity” means that the VSI-distorted voltage V_{dead} is set to be zero during estimation.

TABLE VI
RESULT COMPARISONS ON PMSM PARAMETER IDENTIFICATION BETWEEN WITH CONSIDERING VSI NONLINEARITY AND WITHOUT CONSIDERING VSI NONLINEARITY UNDER NORMAL TEMPERATURE

Estimated Parameters	with considering VSI nonlinearity	without considering VSI nonlinearity
$R(\Omega)$	0.372	0.390
$\psi_m(\text{mWb})$	78.07	77.6
$L_d(\text{mH})$	3.138	3.211
$L_q(\text{mH})$	3.683	3.716
$B(\text{N.m/Rad/s})$	0.062	0.0618
$J(\text{Kg.m}^2)$	$7.36e-5$	$6.97e-5$

Table VI presents all the estimated machine parameters including electrical and mechanical parameters, with and without considering the VSI nonlinearity. The estimated machine parameters without considering the VSI nonlinearity are $0.390(\Omega)$,

77.6(mWb), 3.211(mH), 3.716(mH), 0.0618(N.m/rad/s) and $6.97 \times 10^{-5}(\text{kgm}^2)$ for the winding resistance, rotor flux linkage, d-axis inductance, q-axis inductance, viscous friction coefficient and moment of inertia, respectively. It is obvious that there exist differences between the estimated values with and without considering the VSI nonlinearity for the PMSM parameter estimation. For example, the estimated resistance is 0.372 (Ω) when considering VSI nonlinearity at normal temperature condition, whereas the estimated winding resistance value without considering VSI nonlinearity is 0.390 (Ω), which is larger than the value of with considering VSI nonlinearity (with an error of $(0.390-0.372)/0.372 \approx 5\%$). Obviously, the estimated winding resistance is much more accurate with respect to the nominal value by considering VSI nonlinearity. The observations are the same to other electrical parameter estimation such as rotor flux linkage and dq-axis inductance as in Table VI. This is mainly due to the fact that the VSI nonlinear disturbance voltage (i.e, $V_{\text{dead}} \cdot D_d$ and $V_{\text{dead}} \cdot D_q$ in (2a) and (2b)) can result in an increase in the estimated winding resistance. From the experiment, the distort voltage V_{dead} is about 0.1V, the two terms $D_q \cdot V_{\text{dead}}$ (about 0.4V) and $D_d \cdot V_{\text{dead}}$ (about 0.2V) could introduce an error into the estimation of the PMSM parameters. So, after Clarke and Park transforms, the dq-axis voltage will change because $D_q \cdot V_{\text{dead}}$ can significantly affect the winding resistance and flux linkage estimation. It is noted that the estimates of mechanical parameters are similar to that for the case of without considering the VSI nonlinearity, as for this case the parameters are not independent of the VSI nonlinearity. The reason is that, the value electric parameter will influence the accuracy of mechanical parameters estimation as the mechanical parameters are calculated with the electrical parameters. For example, the value of electromagnetic torque is related to the rotor PM flux linkage. Thus, the VSI nonlinearity will affect greatly the accuracy of the estimated machine parameters and the VSI nonlinearity cannot be negligible.

V. CONCLUSION

In this study, a global identification method was proposed for estimating the PMSM electrical parameters and mechanical parameters with the consideration of VSI nonlinearity. To sum up, the major contributions of this study include:

- 1) A global identification method for estimating parameters of PMSM drives system, including electrical parameters, mechanical parameters and VSI disturbance voltage. In the parameter estimation model, the VSI nonlinearity, electrical and mechanical sub-systems are treated as a whole system and parameter estimation is formulated as a single optimization problem. All system parameters can be estimated simultaneously by solving the optimization problem without a priori knowledge of the inner machine structure.
- 2) A new dynamic learning estimator for tracking the electrical and mechanical parameters of PMSM drive by using dynamic self learning particle swarm optimization (DSLPSO). In DSLPSO, a novel movement modification equation with dynamic exemplar learning strategy is designed to ensure its diversity and better manage the exploitation and exploration during the search process. Moreover, a nonlinear multi-scale based learning operator is introduced for accelerating the convergence speed

of the Pbest particles and a dynamic opposition-based learning (OBL) strategy is designed to facilitate the gBest particle to explore a potentially better region.

In the proposed parameter estimation model the effect of cross-coupling magnetic saturation was not considered. This is a limitation of the proposed method. In our future work, we will investigate a new parameter estimation model for machine parameter estimation including the consideration of nonlinearities as saturation and viscous torque not proportional to the speed. Potentially, the parameter estimation method presented in this paper can be incorporated into a robust motor control system to counteract parameter uncertainties, or fault diagnosis system where the variations of key parameters can be used as a feature of fault symptoms. The proposed method can be applied for system parameter estimation for PMSM-based large equipment such as railway transportation and wind power generation system.

References

- [1] J. Yu, P. Shi, H. Yu, B. Chen, and C. Lin, "Approximation-based discrete-time adaptive position tracking control for interior permanent magnet synchronous motors," *IEEE Trans. Cybern.*, vol. 45, no. 7, pp. 1363-1371, Jul. 2015.
- [2] G.L. Wang, L.Z. Qu, H.L. Zhan, J. Xu, L. Ding, G.Q. Zhang, and D.G. Xu, "Self-Commissioning of Permanent Magnet Synchronous Machine Drives at Standstill Considering Inverter Nonlinearities," *IEEE Trans. Power Electron.*, vol. 29, no. 12, pp. 6615-6627, Dec. 2014.
- [3] W. Su, H. Eichi, W. Zeng, and M.-Y. Chow, "A survey on the electrification of transportation in a smart grid environment," *IEEE Trans. Ind. Informat.*, vol. 8, no. 1, pp. 1-10, Feb. 2012.
- [4] Aubert B, Régnier J, Caux S, et al. "Kalman-filter-based indicator for online interturn short circuits detection in permanent-magnet synchronous generators," *IEEE Trans. Ind. Electron.*, vol. 62, no. 3, pp. 1921-1930, March, 2015.
- [5] Vafaie M H, Dehkordi B M, Moallem P, et al. "Minimizing torque and flux ripples and improving dynamic response of PMSM using a voltage vector with optimal parameters," *IEEE Trans. Ind. Electron.*, vol. 63, no. 6, pp. 3876-3888, June, 2016.
- [6] K. Liu, Z.Q. Zhu, D.A. Stone, "Parameter Estimation for Condition Monitoring of PMSM Stator Winding and Rotor Permanent Magnets." *IEEE Trans. Ind. Electron.*, vol. 60, no. 12, pp. 5902 - 5913, Dec, 2013.
- [7] A. S. Babel, J. G. Cintron-Rivera, S. N. Foster, and Strangas, E. G. Evaluation of a Parameter Identification Method for Permanent Magnet AC Machines Through Parametric Sensitivity Analysis. *IEEE Transactions on Energy Conversion*, vol. 29, no. 1, pp. 240-249, March, 2014.
- [8] N. Leboeuf et al., "Inductance calculations in permanent-magnet motors under fault conditions," *IEEE Trans. Magn.*, vol. 48, no. 10, pp. 2605-2616, Oct. 2012.
- [9] W. q. Huang, Y. t. Zhang, X. c. Zhang, G. Sun, "Accurate torque control of interior permanent magnet synchronous machine," *IEEE Trans. Energy Conversion*, vol. 29, no. 1, pp. 29-37, March 2014.
- [10] S. Underwood and I. Husain, "Online parameter estimation and adaptive control of permanent-magnet synchronous machines," *IEEE Trans. Ind. Electron.*, vol. 57, no. 7, pp. 2435-2443, July, 2010.
- [11] X. G. Zhang, Z. X. Li, "Sliding-Mode Observer-Based Mechanical Parameter Estimation for Permanent Magnet Synchronous Motor," *IEEE Trans. Power Electron.*, vol. 31, no. 8, pp. 5732-5745, August, 2016.
- [12] S. Underwood and I. Husain, "Online parameter estimation and adaptive control of permanent-magnet synchronous machines," *IEEE Trans. Ind. Electron.*, vol. 57, no. 7, pp. 2435-2443, 2010.
- [13] T. Senjyu, Y. Kuwae, N. Urasaki, and K. Uezato, "Accurate parameter measurement for high speed permanent magnet," in *Proc. IEEE Power Electron. Spec. Conf.*, Vancouver, BC, Canada, 2001, pp. 772-777.
- [14] Y. Da, X. Shi, and M. Krishnamurthy, "A new approach to fault diagnostics for permanent magnet synchronous machines using electromagnetic signature analysis," *IEEE Trans. Power Electron.*, vol. 28, no. 8, pp. 4104-4112, Aug. 2013.
- [15] L. Montero, W. Mota and C. Jacobina, "A Microcomputer-Based Load Angle and Frequency Measurement," in *Proc. I2MTC*, Brussels, Belgium, 1996, pp. 606-609.
- [16] L. Liu, D. A. Cartes, "Synchronisation based adaptive parameter identification for permanent magnet synchronous motors," *IET Control Theory & Applications*, vol. 1, no. 4, pp. 1015-1022, July, 2007.
- [17] Y. C. Shi, K. Sun, L. P. Huang, and Y. Li, "Online identification of permanent magnet flux based on extended Kalman filter for IPMSM drive with position sensorless control," *IEEE Trans. Ind. Electron.*, vol. 59, no. 11, pp. 4169-4178, Nov. 2012.
- [18] S.-K. Chung, H.-S. Kim, C.-G. Kim, and M.-J. Youn, "A new instantaneous torque control of PM synchronous motor for high performance direct drive applications," *IEEE Trans. Power Electron.*, vol. 13, no. 3, pp. 388-400, May 1998.
- [19] Y. Zhang, Z. Yin, X. Sun and Y. Zhong, "On-line identification Methods of Parameters for Permanent Magnet Synchronous Motors Based on Cascade MRAS," in *Proc. 9th International Conference on Power Electronics-ECCE Asia*, Seoul, Korea, pp. 345-353, Jun. 2015.
- [20] S. Underwood, and I. Husain, "On-line parameter estimation and adaptive control of permanent magnet synchronous machines," *IEEE Trans. Ind. Electron.*, vol. 57, no. 7, pp. 2435-2443, Jun. 2010.
- [21] G. Feng, C. Lai, K. Mukherjee, C. K. Narayan, "Current Injection based On-line Parameter and VSI Nonlinearity Estimation for PMSM Drives Using Current and Voltage DC Components," *IEEE Trans. Transportation Electrification*, Vol. 2, no. 2, pp. 119-128, June, 2016.
- [22] K. Fujita and K. Sado, "Instantaneous speed detection with parameter identification for ac servo system," *IEEE Trans. Ind. Appl.*, vol. 28, no. 4, pp. 864-872, Jul. 1992.
- [23] S. M. Yang and Y. J. Deng, "Observer-based inertia identification for auto tuning servomotor drives," in *Proc. IEEE Conf. Rec. 40th Ind. Appl. Annu. Meet.*, 2005, pp. 968-972.
- [24] A. Piippo, M. Hinkkanen, J. Luomi, "Adaptation of motor parameters in sensorless PMSM drives," *IEEE Trans. Ind. Appl.*, vol. 45, no. 1, pp. 203-212, Jan. 2009.
- [25] S. Wang, S. Shi, C. Chen, G. Yang, and Z. Qu, "Identification of PMSM based on EKF and Elman neural network," in *Proc. ICAL*, Aug. 2009, pp. 1459-1463.

- [26] C.-N. Ko, "Identification of non-linear systems using radial basis function neural networks with time-varying learning algorithm," *IET Signal Process.*, vol. 6, no. 2, pp. 91–98, May, 2012.
- [27] S. M. Yang and J. D. Lin, "Observer-based automatic control loop tuning for servo motor drives," in *Proc. 10th IEEE Int. Conf. PEDS*, 2013, pp. 302–305.
- [28] P. Regulski, D. S. Vilchis-Rodriguez, S. Djurović, and V. Terzija, "Estimation of Composite Load Model Parameters Using an Improved Particle Swarm Optimization Method", *IEEE Transactions On Power Delivery*, vol. 30, no. 2, pp.553-560, April, 2015.
- [29] D. C. Huynh M.W. Dunnigan. Parameter estimation of an induction machine using advanced particle swarm optimisation algorithms. *IET Electr. Power Appl.*, vol. 4, no. 9, pp. 748–760, March, 2010,
- [30] Whei-Min Lin, Tzu-Jung Su, and Rong-Ching Wu, "Parameter Identification of Induction Machine With a Starting No-Load Low-Voltage Test", *IEEE Transactions On Industrial Electronics*, vol. 59, no. 1, pp.352-360, Jan, 2012
- [31] L Liu, WX Liu, and D A Cartes. "Permanent magnet synchronous motor parameter identification using particle swarm optimization," *International Journal of Computational Intelligence Research*, vol.4, no.2, pp.211-218, Feb.2008
- [32] O. Sandre-Hernandez, R. Morales-Caporal, J. Rangel-Magdaleno, H. Peregrina-Barreto, and J. N. Hernandez-Perez, "Parameter identification of PMSMs using experimental measurements and a PSO algorithm," *IEEE Trans. Instrum. Meas.*, vol.64, no.8, pp.2146-2154, Aug. 2015
- [33] Z. H. Liu, J. Zhang, S. W. Zhou, X. H. Li, and K. Liu, "Coevolutionary particle swarm optimization using AIS and its application in multiparameter estimation of PMSM," *IEEE Trans. Cybern.*, vol. 43, no. 6, pp. 1921–1935. Dec. 2013.
- [34] Z. H. Liu, X. H. Li, L. H. Wu, S. W. Zhou, and K. Liu, "GPU-accelerated parallel coevolutionary algorithm for parameters identification and temperature monitoring in permanent magnet synchronous machines," *IEEE Trans. Ind. Informat.*, vol. 11, no. 5, pp. 1220-1230, Oct. 2015.
- [35] Z.H Liu, H.L Wei, Q.C Zhong; K. Liu; X.S Xiao; L.H Wu, "Parameter Estimation for VSI-Fed PMSM based on a Dynamic PSO with Learning Strategies", *IEEE Transactions on Power Electronics*, DOI.10.1109/TPEL.2016.2572186
- [36] Y. Feng, L. Wang, and X. Yu, "AC servo systems, industrial electronics handbook," in *Control Mechatronics*, 2nd ed., J. D. Irvin, Ed. London, U.K.: CRC Press, 2011, ch. 18.
- [37] H. W. Kim, M. J. Youn, K. Y. Cho, and H. S. Kim, "Nonlinearity estimation and compensation of PWM VSI for PMSM under resistance and flux linkage uncertainty," *IEEE Trans. Contr. Syst. Technol.*, vol. 14, no. 4, pp. 589–601, Jul. 2006.
- [38] S. Rahnamayan, H. R. Tizhoosh, and M. M. A. Salama, "Opposition based differential evolution," *IEEE Trans. Evol. Comput.*, vol. 12, no. 1, pp. 64–79, Feb. 2008
- [39] A. A. E. Ahmed, L. T. Germano, and Z. C. Antonio, "A hybrid particle swarm optimization applied to loss power minimization," *IEEE Trans. Power Syst.*, vol. 20, no. 2, pp. 859–866, May, 2005.
- [40] C. F. Juang, "A hybrid of genetic algorithm and particle swarm optimization for recurrent network design," *IEEE Trans. Syst., Man, Cybern. B, Cybern.*, vol. 34, no. 2, pp. 997–1006, Apr. 2004.
- [41] S.H .Ling, H.H.C .Iu; K.Y. Chan, H.K .Lam, B.C.W .Yeung and F.H. Leung," Hybrid Particle Swarm Optimization With Wavelet Mutation and Its Industrial Applications ", *IEEE Trans. Syst., Man, Cybern. B, Cybern.*, vol.38, no.3, pp. 743 – 763, Jun. 2008.
- [42] J. J. Liang, A. K. Qin, P. N. Suganthan, and S. Baskar, "Comprehensive learning particle swarm optimizer for global optimization of multimodal functions," *IEEE Trans. Evol. Comput.*, vol. 10, no. 3, pp. 281–295, Jun. 2006.
- [43] Z.H.Zhan, J. Zhang, Y. Li, and H. S.H. Chung. "Adaptive Particle Swarm Optimization," *IEEE Trans. Syst., Man, Cybern. B, Cybern.*, vol. 39, no. 6, pp.1362-1381, Dec.2009.