

*promoting access to White Rose research papers*



**Universities of Leeds, Sheffield and York**  
**<http://eprints.whiterose.ac.uk/>**

---

This is an author produced version of a paper published in **Wear**.

White Rose Research Online URL for this paper:

<http://eprints.whiterose.ac.uk/10488>

---

**Published paper**

Arias-Cuevas, O., Li, Z., Lewis, R., Gallardo-Hernandez, E.A. (2010) *Rolling-sliding laboratory tests of friction modifiers in dry and wet wheel-rail contacts*, *Wear*, 268 (3-4), pp. 543-551

<http://dx.doi.org/10.1016/j.wear.2009.09.015>

---

# Rolling-Sliding Laboratory Tests of Friction Modifiers in Dry and Wet Wheel-Rail Contacts

O. Arias-Cuevas<sup>\*1</sup>, Z. Li<sup>\*</sup>, R. Lewis<sup>#</sup> and E.A. Gallardo-Hernández<sup>#</sup>

<sup>\*</sup> Delft University of Technology, Faculty of Civil Engineering and Geosciences,  
Section of Road and Railway Engineering, Stevinweg 1, 2628 CN Delft, The  
Netherlands

<sup>#</sup> The University of Sheffield, Department of Mechanical Engineering, Mappin  
Street, S1 3JD Sheffield, The United Kingdom

<sup>1</sup> Corresponding author. Tel.: +31 15 27 82773; fax: +31 15 27 83443. E-mail  
address: o.ariascuevas@tudelft.nl

## ***Abstract***

A popular practice is the application of friction modifiers to increase the adhesion level between wheel and rail under different contamination conditions.

Particularly, two friction modifiers have been used or tested in several railway networks as adhesion enhancers to facilitate the traction and braking operation under poor adhesion conditions. However, the railway operators and infrastructure managers only count with practical observations that do not elucidate completely the effectiveness and side effects of these adhesion enhancers. In this paper, a twin-disk roller rig has been used to study their performance in dry and wet contacts under closely controlled laboratory

conditions. The adhesion characteristics of both friction modifiers are examined for different slip ratios. The constituents of the friction modifiers are identified and the solid components are analyzed. Furthermore, the wheel and rail disks are examined after a series of dry tests to analyze the mass loss, surface damage, modification of surface hardness and roughness, and subsurface deformation caused by the friction modifiers compared to dry contacts.

**Keywords:** Wheel-rail adhesion; Rolling-sliding; Friction modifiers; Rail-wheel tribology.

## ***1. Introduction***

In the railway industry, the friction available between wheel and rail during braking and traction operations is known as wheel-rail adhesion. Whilst too high friction in the wheel-rail contact is undesired because it leads to wear and rolling contact fatigue (among other problems), it must be sufficient to ensure an adequate adhesion level for the traction and braking operation of rail vehicles. The adhesion, or the adhesion coefficient (also known as traction coefficient), is given by the ratio of the tangential (i.e. braking or traction) force and the normal force at the wheel-rail contact. Adhesion is influenced by vehicle speed, wheel slip, contact pressure, environment conditions, and many other factors. Many studies on wheel-rail adhesion have already been conducted in both laboratory and field tests. Beagley et al. presented pioneering work in 1975 about the influence of water on adhesion [1]. They also investigated the influence of other factors on adhesion, such as railhead debris and oil contamination [2-3]. More

recently, laboratory studies on adhesion for dry and wet wheel-rail contacts have also been carried out with a twin-disk roller rig [4-6] and with a full-scale roller rig [7].

In recent years, friction management has been carried out extensively in the majority of railway networks with different purposes. Some friction modifiers (FMs) have been designed to eliminate the negative slope of the traction curve that is responsible of the stick-slip oscillations, thus overcoming the squealing noise and corrugation phenomena that can especially occur in small-radius curves [8-9]. FMs have also been aimed at reducing the occurrence rolling contact fatigue (e.g., head checks) and the rates of wear [10]. This paper deals with another popular practice of friction management, in which FMs are used to increase the adhesion between wheel and rail facilitating the traction and braking operation under poor adhesion conditions. Such FMs are also known as adhesion enhancers. Sanding from the train or locomotive is used on railway networks world wide [11]. Laboratory studies on sanding to investigate its effect on adhesion and its damage to wheel and rail have been published [4, 12]. Besides sanding, other adhesion enhancers have been used or tested on several railway networks. In countries such as the United Kingdom and the Netherlands, a commercial adhesion enhancer has been used since the late 90's to overcome poor adhesion conditions, especially due to leaf layer contamination and small amounts of water during the autumn season [13]. Nevertheless, there exists a lack of research on this adhesion enhancer to understand both its adhesion characteristics

and its possible damage to wheels and rails. Therefore, the railway operators and infrastructure managers only count with practical observations that do not elucidate completely the effectiveness of the adhesion enhancer used on their network. In this paper, a laboratory study of this widely used adhesion enhancer is presented together with another adhesion enhancer designed for wet wheel-rail contacts due to rainfall.

The aim of this work is to investigate the performance of the two adhesion enhancers in dry and wet contact conditions. A study of these adhesion enhancers in leaf contaminated contacts has also been carried out [14]. The two adhesion enhancers are named FMs throughout this paper. Both FMs are water-based and have been designed to increase the adhesion in different conditions. Friction modifier A (FMA) has been tested successfully in a train depot in Japan to overcome adhesion problems related to rainfall. FMA is to be applied to the top of both rails in a very thin layer. Friction modifier B (FMB) has extensively been used in autumn on the Dutch and British railways networks to mitigate adhesion problems mostly due to leaves and small amounts of water. In The Netherlands, FMB is primarily trainborne applied to top of both rails by means of a speed dependent pumping system, which delivers 4 cc/m per rail. In this work, a twin-disk roller rig has been used to simulate the wheel-rail contact in controlled laboratory conditions. The adhesion characteristics of the two FMs have been studied in dry and wet conditions for up to four different slip ratios: 0.5, 1, 2 and 3%. The damage caused to the wheel and rail disks by the FMs has also been

analyzed. The constituents of the FMs have been examined and their influence on adhesion and disk damage has been assessed.

## **2. Test set-up**

### **2.1. Test roller rig**

The rolling-sliding tests were conducted on the SUROS (Sheffield University Rolling Sliding) roller rig, shown in Fig. 1. A detailed description of the roller rig is given in [15]. The test disks were mounted on independent shafts. By means of a hydraulic jack, a controlled contact pressure was achieved during the test. The slip ratio between the disks was prescribed by setting different rotational speed of the shafts and maintained constant throughout each test with a controller. The slip ratio is defined in Eq. (1), where  $w$  and  $r$  are the rotational speed and rolling radius of the disks, respectively. The adhesion coefficient was calculated with the readings of the torque transducer and the load cell, as given in Eq. (2) by  $T$  and  $F_N$ , respectively. A personal computer was used to acquire the data and to control both the speed and the load.

$$Slip = \frac{w_{wheel} \cdot r_{wheel} - w_{rail} \cdot r_{rail}}{w_{wheel} \cdot r_{wheel} + w_{rail} \cdot r_{rail}} \cdot 200\% \quad (1)$$

$$\mu_{adhesion} = \frac{T}{F_N \cdot r_{rail}} \quad (2)$$

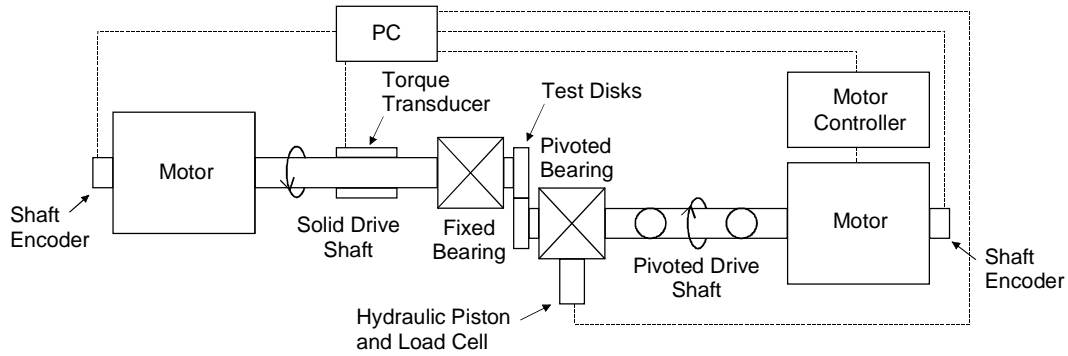

Fig. 1. Schematic representation of the SUROS roller rig.

## 2.2. Test disks

The test disks were cut from rails and wheel tires retired from service in the Dutch railway network; R260Mn and B5T steel for the rail and wheel, respectively. The disks were machined with their axes perpendicular to the longitudinal axis of both wheel and rail (see Fig. 2). The Vickers macro-hardness of the wheel and the rail steel used in the tests was measured as  $267 \text{ HV}_{20\text{kg}}$  and  $281 \text{ HV}_{20\text{kg}}$  on average, respectively. Prior to testing, the disks were cleaned in a bath of ethanol by means of ultrasonic vibration. The roughness of the new disks was measured as  $1 \pm 0.2 \mu\text{m}$  on average with a profilometer. Before assembling the disks into the roller rig, their diameter was measured with a vernier calliper as necessary for the calculations of slip and adhesion coefficient.

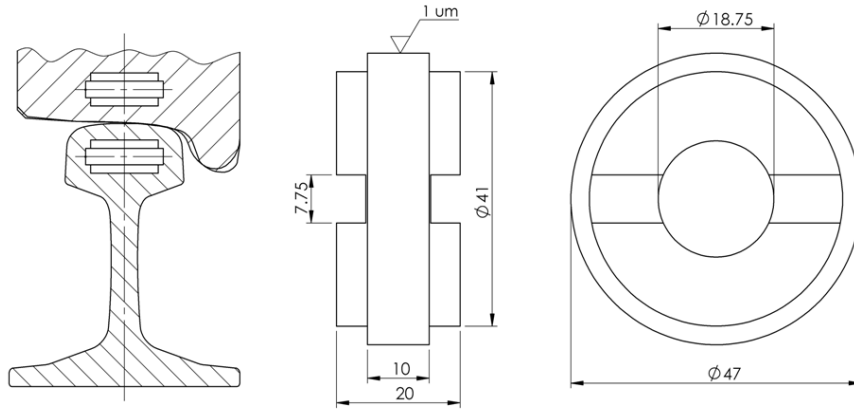

Fig. 2. Orientation and dimensions of the wheel and rail disks specimens.

### 2.3. Tested friction modifiers

Two top-of-the-rail water-based FMs have been tested in this work. Microscope photographs of the dried samples are given in Fig. 3. The particle size distribution of both FMs was measured by means of a laser particle analyzer, as shown in Fig. 4. FMA contains several types of solid components, which have different physical and tribological characteristics that provide the final product with varied functionalities such as friction enhancement and film transfer between wheel and rail. Two size ranges of solid particles are predominant in the mix; the small particles ( $\approx 10 \mu\text{m}$ ) surround the large ones ( $\approx 100 \mu\text{m}$ ) providing them support. Furthermore, there are several polymeric components in FMA, all of which assist in promoting adherence to the wheel and rail steel surfaces. In Fig. 3, it can be seen that the particles agglomerate after drying in the oven. FMB is a mixture composed of an inorganic gelling agent, stabilizer, water, sand grains and stainless steel particles. The gelling agent promotes the adherence of the mix to the wheel and rail surfaces, while the stabilizer provides a reasonable storage life. The stainless steel particles guarantee appropriate electrical properties of the mix,



which are necessary due to the trainborne application of FMB on the rails. It can be seen from Fig. 3 that the sand grains vary in size and type, most probably coming from different types of rocks. The black coloured particles correspond to the stainless steel, as pointed in Fig. 3.

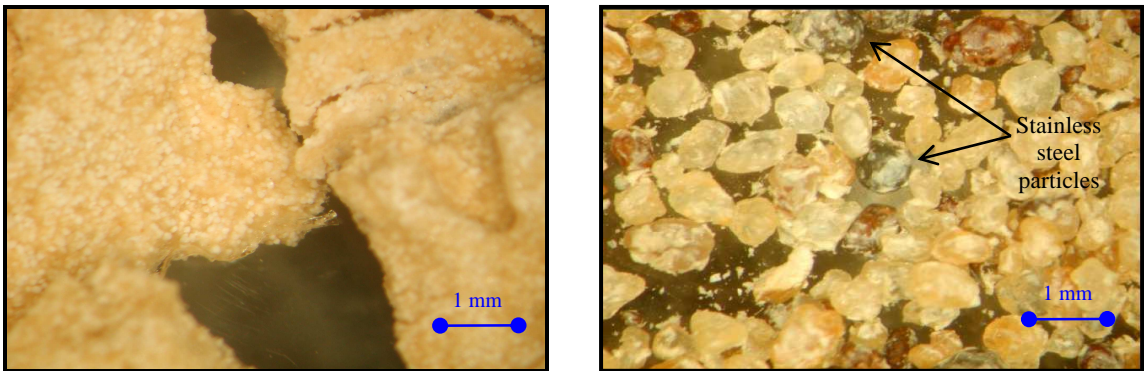

Fig. 3. Microscope photographs of FMA (left) and FMB (right).

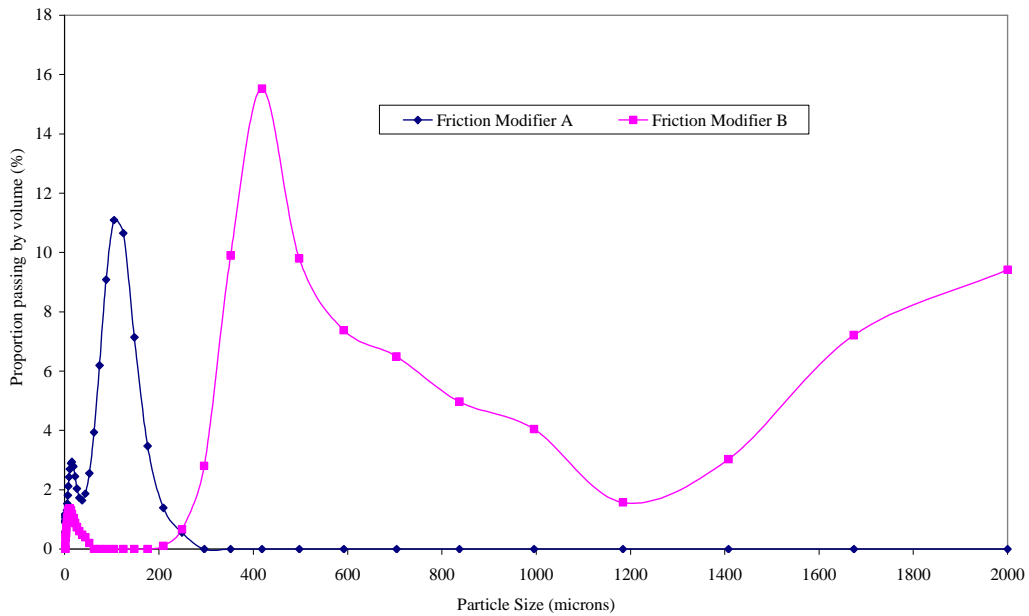

Fig. 4. Particle size distribution of FMA and FMB.

## 2.4. Test procedure

In the tests the wheel disk rotated faster than the rail disk; the rotational speed of the rail was maintained at 400 rpm, equivalent to 1 m/s of rolling speed. Since cylindrical disks were used in the experiments, a line contact of 10 mm width was present in the tests. A load of 4.7 kN was applied on the disks producing a maximum Hertzian pressure of 1.2 GPa in the contact zone, which is representative of the contact between wheel tread and top of rail for passenger trains in the Netherlands. When testing the performance of the two FMs, they were painted onto the rail disk surface prior to the start of the test, as shown in Fig. 5. Due to the different solid contents of the FMs, completely covering the rail disk with the FMs yielded different masses: 0.4-0.5 g for FMA and 0.7-0.8 g for FMB. In the wet tests, the water was applied to the rail disk surface once the disks were running in order to simulate rainfall conditions, as depicted in Fig. 5. For each test conducted with the FMs in both dry and wet conditions a baseline was first obtained so as to compare the performance of FMs with the untreated conditions. The dry tests were run for 2000 cycles at 0.5, 1, 2 and 3% slip; on the other hand, the wet tests were run for 1000 cycles at 0.5, 1 and 2% slip. The number of cycles in wet conditions was halved because of the enhanced removal of FMs in presence of water. The slip ratios used in this work correspond to typical values that can be found in the contact between wheel tread and top of the rail. A run-in conditioning test of 4000 cycles in dry conditions at 0.5% slip was run for each new pair of disks.

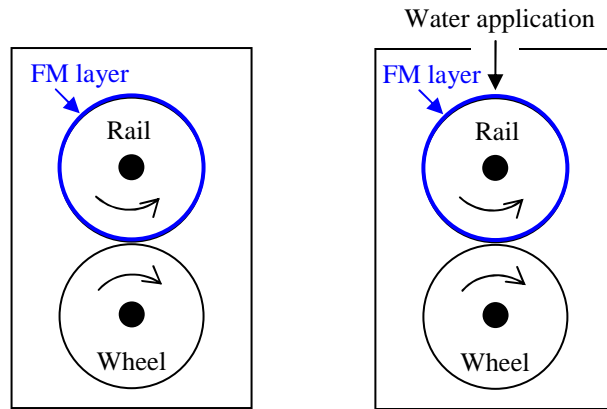

Fig. 5. Test procedure for dry tests (left) and wet tests (right).

### 3. Results

#### 3.1. Dry tests

The adhesion results of the two FMs together with the baseline for 0.5, 1, 2 and 3% slip in dry conditions are given in Figs. 6-9. The baseline gave the largest adhesion, with adhesion coefficients between 0.30 and 0.60 for the slip range considered. The maximum adhesion coefficient was observed at 2% slip—this is in good agreement with previous research carried out with this roller rig [4, 16]. Furthermore, FMA led to moderate adhesion coefficients before starvation occurred and metal-metal contact was reached. The adhesion coefficients for dry contacts with FMA could be estimated to be between 0.15 and 0.35 depending on the slip ratio. On the other hand, FMB led to an adhesion range between 0.25 and 0.55 before starvation.

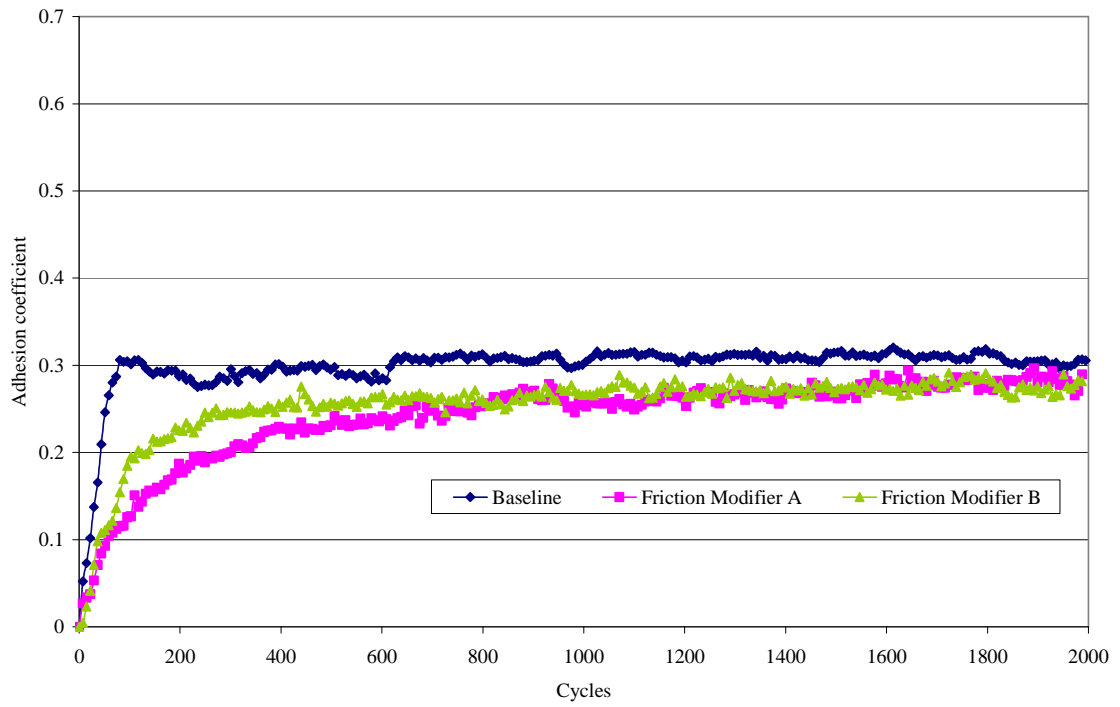

Fig. 6. Adhesion tests in dry conditions at 0.5% slip.

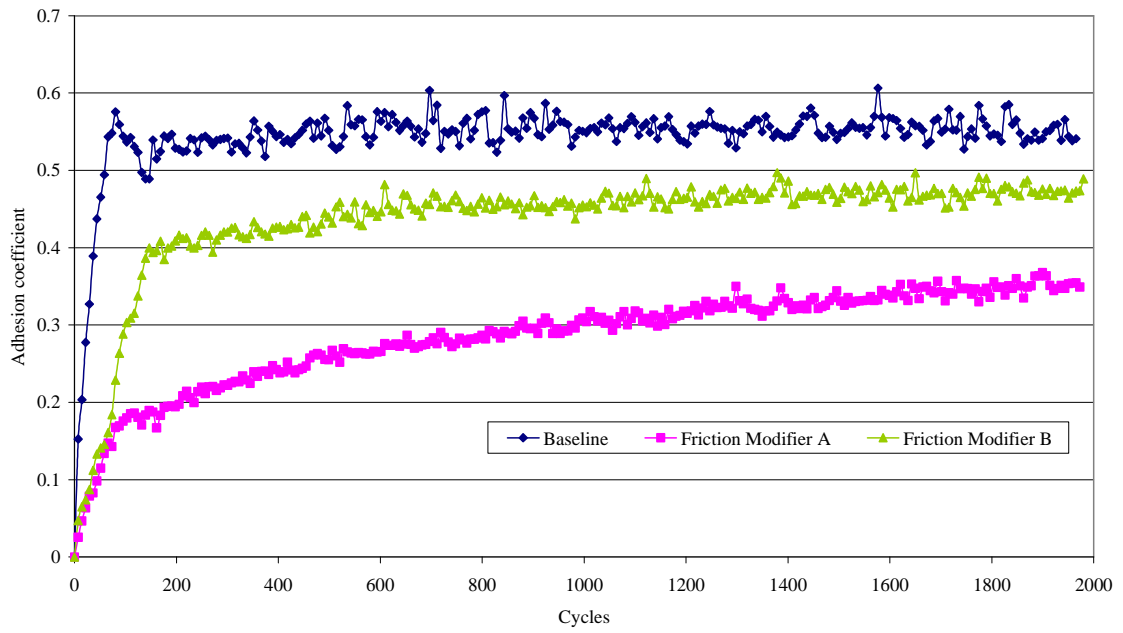

Fig. 7. Adhesion tests in dry conditions at 1% slip.

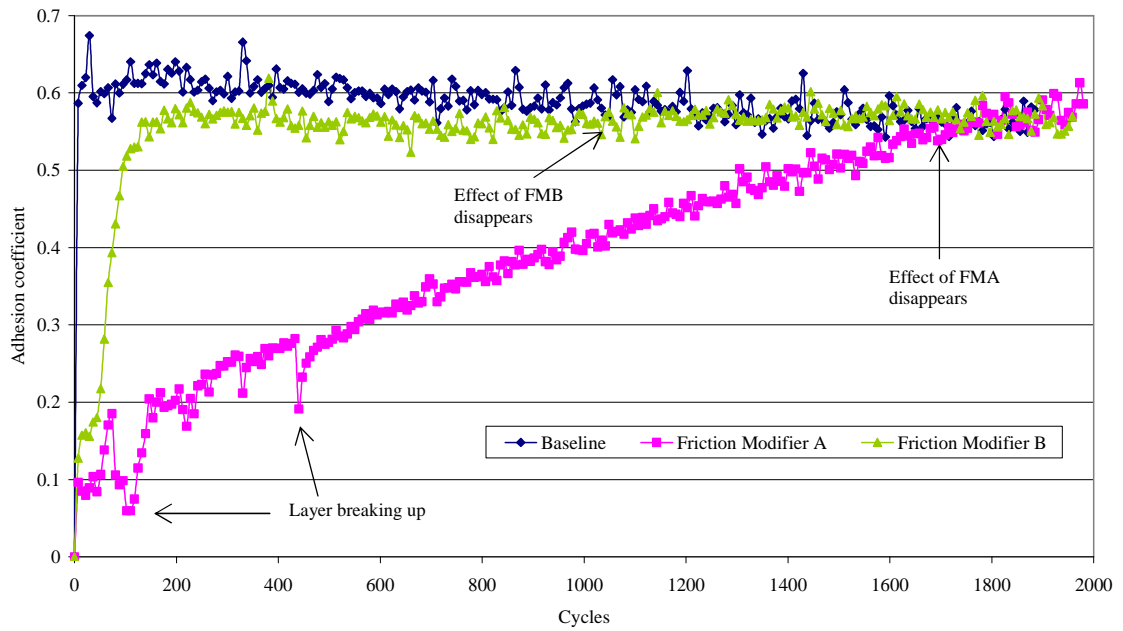

Fig. 8. Adhesion tests in dry conditions at 2% slip.

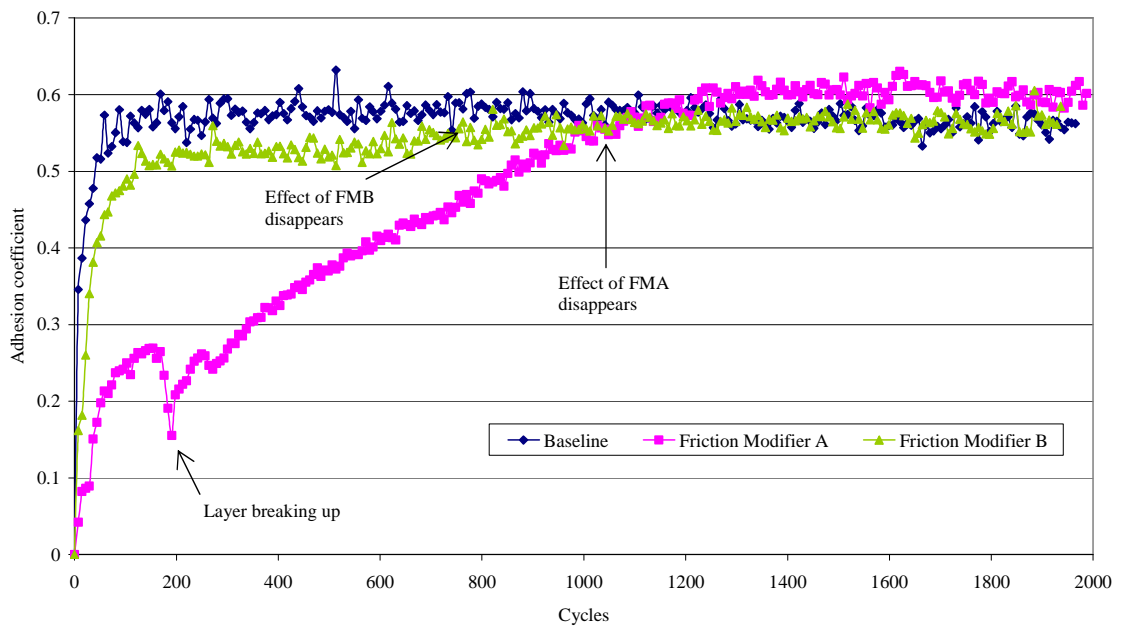

Fig. 9. Adhesion tests in dry conditions at 3% slip.

The traction curve, which describes the variation of the adhesion coefficient with the slip, is given in Fig 10 for the dry tests with baseline and FMs. It must be noted that the adhesion coefficients used for the adhesion curve had been taken from those registered at 80 cycles in the tests depicted in Figs. 6-9. This number of cycles was selected as the best compromise between two restrictions. On one hand, the number of cycles could not be too low because the roller rig required around 20-50 cycles to increase the slip from null (beginning of the test) to the set value. On the other hand, the selected number of cycles could not be too high to ensure that the friction modifier had not been removed from the disks surfaces. The data points have arbitrarily been connected by straight lines in Fig. 10. It can be seen that the adhesion coefficient in baseline conditions saturates at around 2% slip followed by a decreasing slope. This decreasing slope may excite stick-slip oscillations leading to the occurrence of squeal noise and corrugation, as indicated in the introduction. Both FMA and FMB appeared to remove the decreasing slope, at least for the slip regime considered in this investigation.

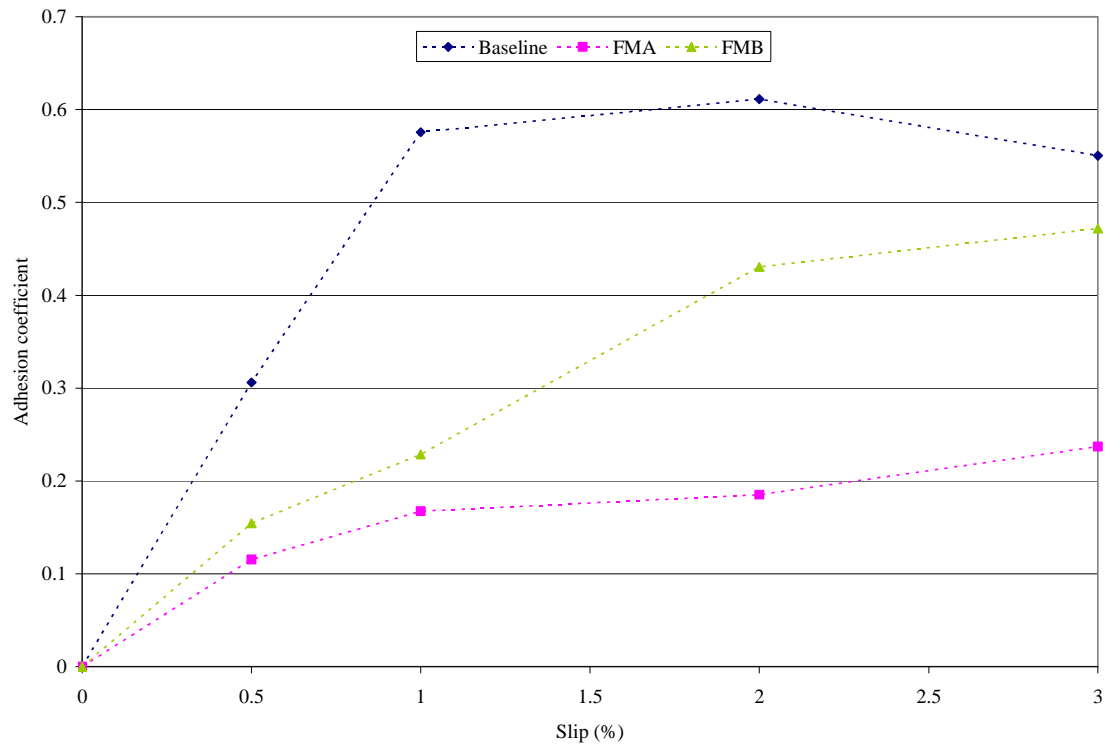

Fig. 10. Traction curve of baseline, FMA, and FMB in dry conditions.

The lasting effect of the FMs was examined in dry conditions. It can be seen that the effect of both FMs on adhesion remained throughout the test for slip values up to 1%. At higher values of slip, metal-metal contact was eventually reached and the adhesion level equalled that one of the baseline. This gives evidence that the higher the slip the faster the FM is removed from the disk surfaces. Furthermore, FMA showed a longer lasting effect than FMB at 2 and 3% slip, as shown in Figs. 8-9. This could be attributed to their different composition, because it seems that FMA has a stronger structure that retains the product in contact with the disk surfaces. In addition, some sudden drops in the

adhesion coefficient could be observed in the initial part of the adhesion curves for FMA at 2 and 3% slip, which could be attributed to the breaking up of the third body layer present in the contact.

Due to the slip between the disks, there exists a mass transfer of the FM from the surface of the rail disk to the wheel disk. Such phenomenon has already been investigated by other researchers [17-18]. The mass transfer could be observed in the laboratory during each test. Due to this mass transfer the rail disk was predominantly clean at the end of each test; whereas the wheel disk normally had a layer composed of broken FM and oxides.

In order to assess the damage that the FMs may cause to wheel and rail, three pairs of disks used for a complete set of dry tests were examined. Each pair was used to run 12000 dry cycles, which consisted of 4000 initial run-in cycles at 0.5% slip and 2000 cycles at each slip ratio: 0.5, 1, 2 and 3%. Firstly, the surfaces of the three pairs of disks were examined by means of optical microscopy, as shown in Figs. 11-13. Note that due to the radial curvature of the disks, the left and right edges are darker than the centred area. A substantial difference in surface morphology could be observed between wheel and rail for all contact conditions. For the baseline tests, the rail disk presented surface corrugation, surface cracks and small pits that are associated with ratchetting wear. This type of wear had also been observed in previous work [12, 19]. On the other hand, oxidative wear was observed on the wheel disk surface, and a brown reddish oxide layer was seen on the surface together with exposed steel material. When



using FMA, only a little ratchetting wear seemed to take place with several small pits on both wheel and rail disk surfaces, but in far less extent than in the baseline. Moreover, indentations and scratches were observed when using FMB (see Fig. 13) that are attributed to the interaction with the solid particles. The size of these indentations was around 1 mm in characteristic diameter and they were present on both wheel and rail disks. These indentations were caused by sand particles indenting the wheel and rail steel material. Besides abrasive wear, oxidative wear could also be seen on the wheel surface. On the other hand, ratchetting wear was predominant on the rail disk surface with the presence of small pits.

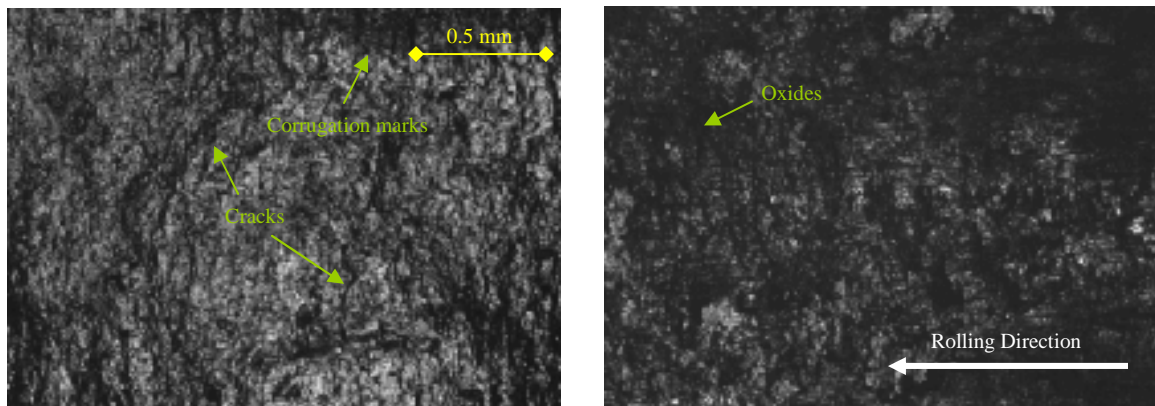

*Fig. 11. Micro-photographs of the rail (left) and wheel (right) disks surfaces after 12000 cycles in dry conditions with baseline.*

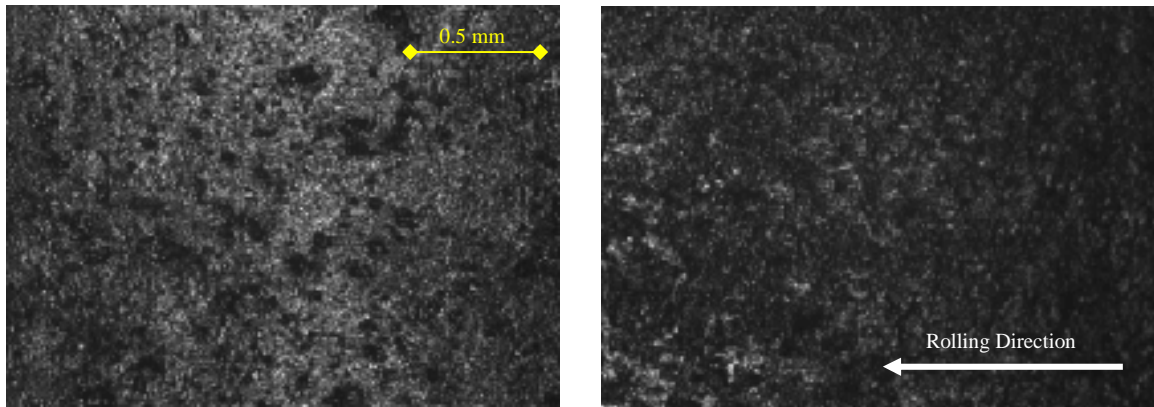

*Fig. 12. Micro-photographs of the rail (left) and wheel (right) disks surfaces after 12000 cycles in dry conditions with FMA.*

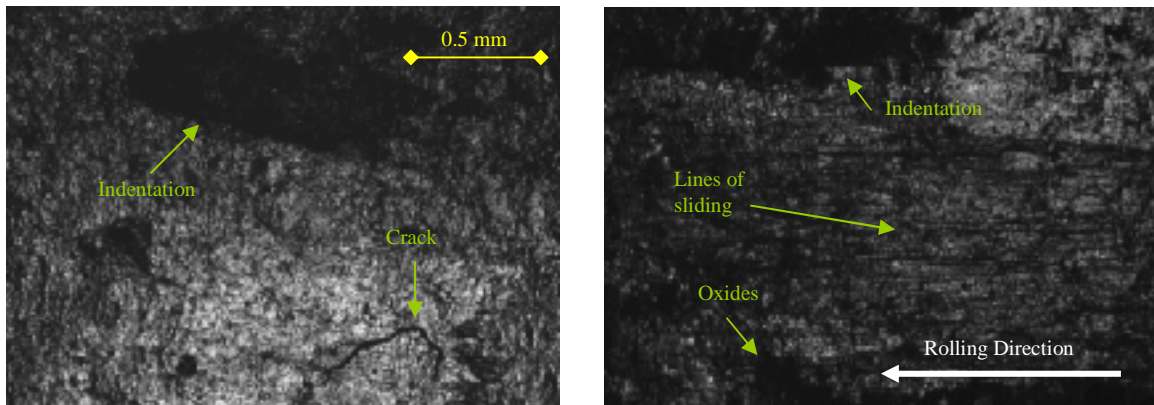

*Fig. 13. Micro-photographs of the rail (left) and wheel (right) disks surfaces after 12000 cycles in dry conditions with FMB.*

The surface roughness was measured after the complete set of tests, as given in Table 1. The large roughness measured in the wheel disk of the baseline tests is attributed to the presence of oxide layers of different thickness in relation to the bulk steel material. A similar effect, although in less degree, was observed in the FMB tests. The rail disk presented almost unaltered roughness values in the tests

with FMA and FMB. However, there was an increase in roughness of the rail disk for the baseline test due to the corrugation marks.

*Table 1. Average surface roughness of wheel and rail disks after 12000 cycles in dry conditions.*

	Initial	Baseline	Friction Modifier A	Friction Modifier B
Wheel disk	1±0.2 μm	7±3 μm	2.75±0.65 μm	4±1 μm
Rail disk	1±0.2 μm	2.7±1 μm	0.9±0.3 μm	1.1±0.3 μm

The subsurface of the three pairs of disks was examined under a microscope in cross and longitudinal sections, as shown in Figs. 14-15. The differences in the contrast of Figs. 14-15 are due to the different amounts of etching during metallographic preparation. The deepest subsurface deformation seemed to be observed for the baseline; whereas, FMA led to the shallowest subsurface plastic deformation (see Fig. 14). The plastic deformation depth is in agreement with the adhesion results presented above, the higher the tangential load the deeper the plastic deformation. For all contact conditions, the rail presented deeper plastic deformation layer than the wheel, which could be attributed to the different microstructure of the two steels. Both steels were composed of ferrite and pearlite; however, more pearlite was observed in the rail steel. Furthermore, smaller pearlite grain size was observed in the wheel steel. Due to the high adhesion coefficient values in the tests, the maximum shear stress occurred at the surface, which caused a highly strained layer, as noticeable in Figs. 14-15.

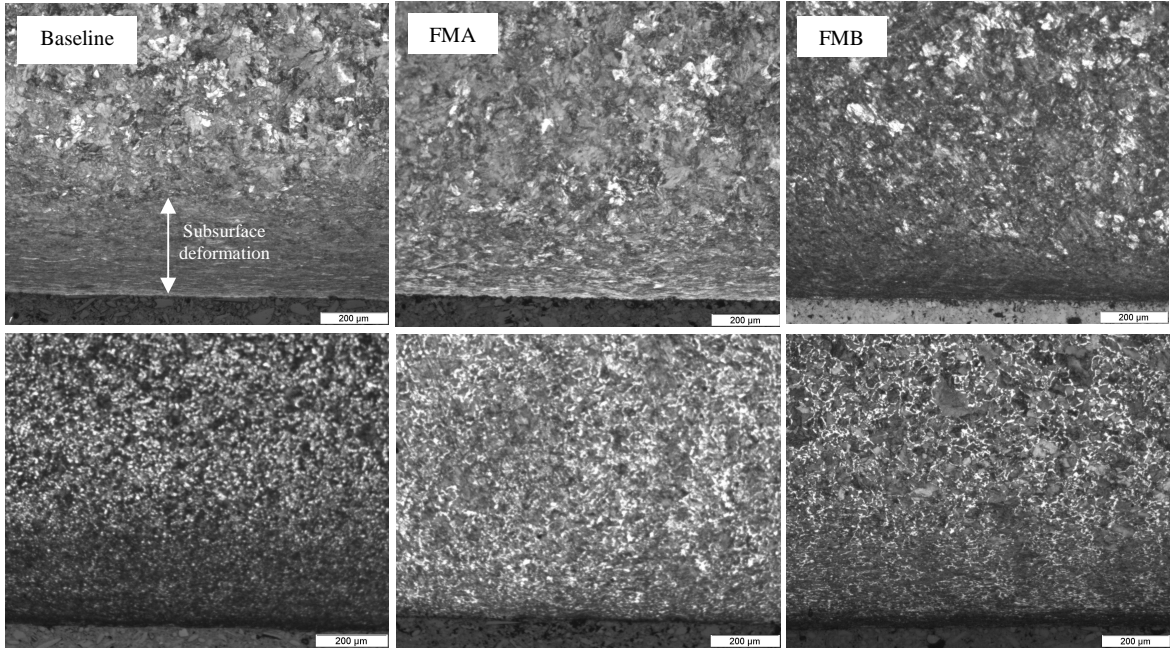

*Fig. 14. Sub-surface micro-photographs of the cross section of the rail (top) and wheel (bottom) disks after 12000 cycles in dry conditions with baseline, FMA, and FMB.*

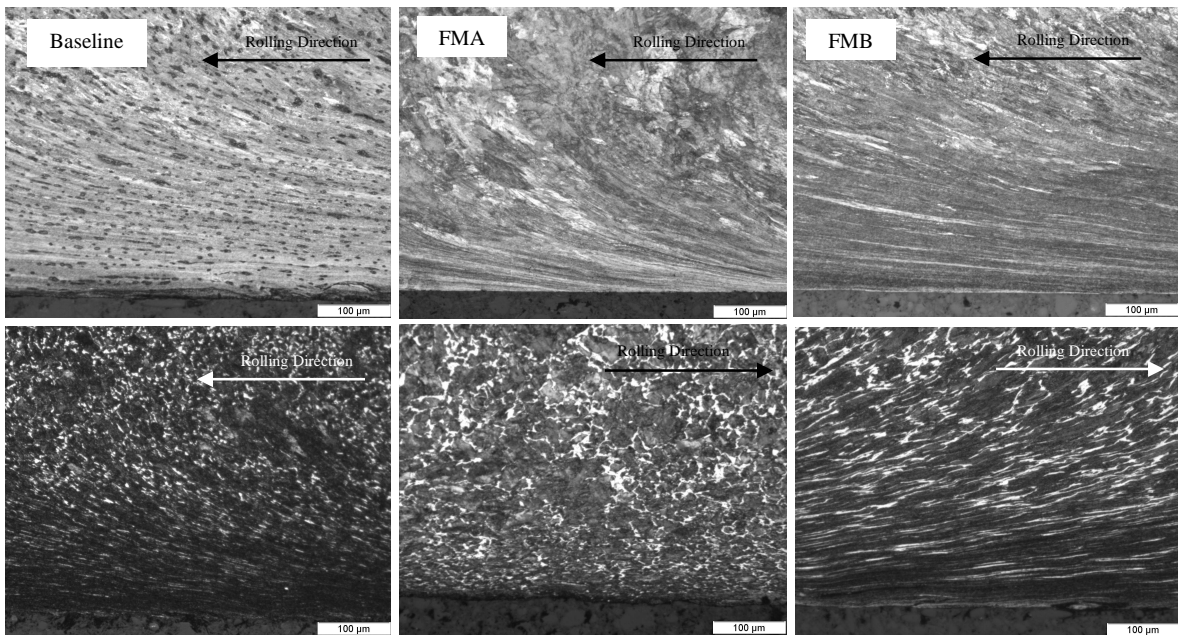

*Fig. 15. Sub-surface micro-photographs of the longitudinal section of the rail (top) and wheel (bottom) disks after 12000 cycles in dry conditions with baseline, FMA, FMB.*

The hardness of the surface of the three pairs of disks was measured using Vickers macro-indentation technique with a 20 kg load (see results in Table 2). The largest hardening effect was observed for both the baseline and the FMB. This can be explained by examination of the adhesion history during the tests (Figs. 6-9). The lower adhesion coefficients obtained with FMA led to the lowest work-hardening effect of the surface. Furthermore, the rail work hardened more than the wheel, which could be attributed to the different steel microstructure. In the tests with FMs, it may be possible that the firm adherence of the third body layer on the wheel disk (rather than on both disks) could also have influenced the different work-hardening between wheel and rail. Berthier et al. [20] showed that a third body layer present between wheel and rail surfaces can accommodate their relative displacement (or slip) so that the shearing of the near-surface grains of wheel and rail surfaces is decreased, thus reducing the work-hardening effect. Since the third body layer appeared to be firmly adhered to the wheel disk in these tests, the extent of grain deformation in the near-surface of wheel disk could have been reduced compared to the rail because of a different shear stress distribution across the depth in the wheel and rail disks. However, further investigation would be required to validate this last hypothesis.

*Table 2. Average hardness of the surface of wheel and rail disks after 12000 cycles in dry conditions.*

	Initial	Baseline	Friction Modifier A	Friction Modifier B
Wheel disk	267 HV <sub>20kg</sub>	420 HV <sub>20kg</sub>	290 HV <sub>20kg</sub>	420 HV <sub>20kg</sub>

Rail disk	281 HV <sub>20kg</sub>	490 HV <sub>20kg</sub>	390 HV <sub>20kg</sub>	470 HV <sub>20kg</sub>
-----------	------------------------	------------------------	------------------------	------------------------

The accumulated wear of the three pairs of disks was determined by means of mass loss measurements using electronic scales with  $\pm 0.05$  mg accuracy (see Table 3). Note that the wheel disks ran 150 cycles more than the rail disks due to the slip; however, it only represents  $\sim 1\%$  of the total cycles so that the extra wear amount may be neglected. The largest accumulated wear corresponded to the wheel for all contact conditions, which is attributed to the softer wheel steel material. Similar findings have been reported in previous work [12]. The baseline showed the largest wear rates, while the lowest were found when using FMA. This is found in good agreement with the adhesion results presented in Figs. 6-9.

Table 3. Mass loss of the disks after 12000 cycles in dry conditions with baseline, FMA and FMB.

	Baseline		FMA		FMB	
	Wheel	Rail	Wheel	Rail	Wheel	Rail
$m_{\text{loss}}$ (mg)	114.9	90.1	30.3	28.4	109.6	70.5

### 3.2. Wet tests

In order to simulate the wet wheel-rail contact, water was applied to the rail disk once the disks were running, as previously depicted in Fig. 5. In this way, rainfall conditions with pre-application of the FMs were simulated with these tests. Two different application methods of water were first tested (at 0.5% slip) to verify their suitability in reducing the adhesion in a uniform and consistent way. Water was applied by means of a pipette and a spray bottle. Furthermore, different

amounts were also tested with both methods. It was concluded that the effect of water on adhesion could be controlled better with drops of water from the pipette than with the spray bottle. Mass measurements of water applied with the pipette showed good repeatability only for the first drop. Therefore, only one drop of water was used for the tests with a mass content of 0.04 g. One of the goals in the wet tests was to assess the recovery time, which is defined as the number of cycles necessary to recover to the dry adhesion level prior to water application (see Fig. 16). Therefore, the recovery time determined the number of cycles in which the applied water exerted an influence on adhesion.

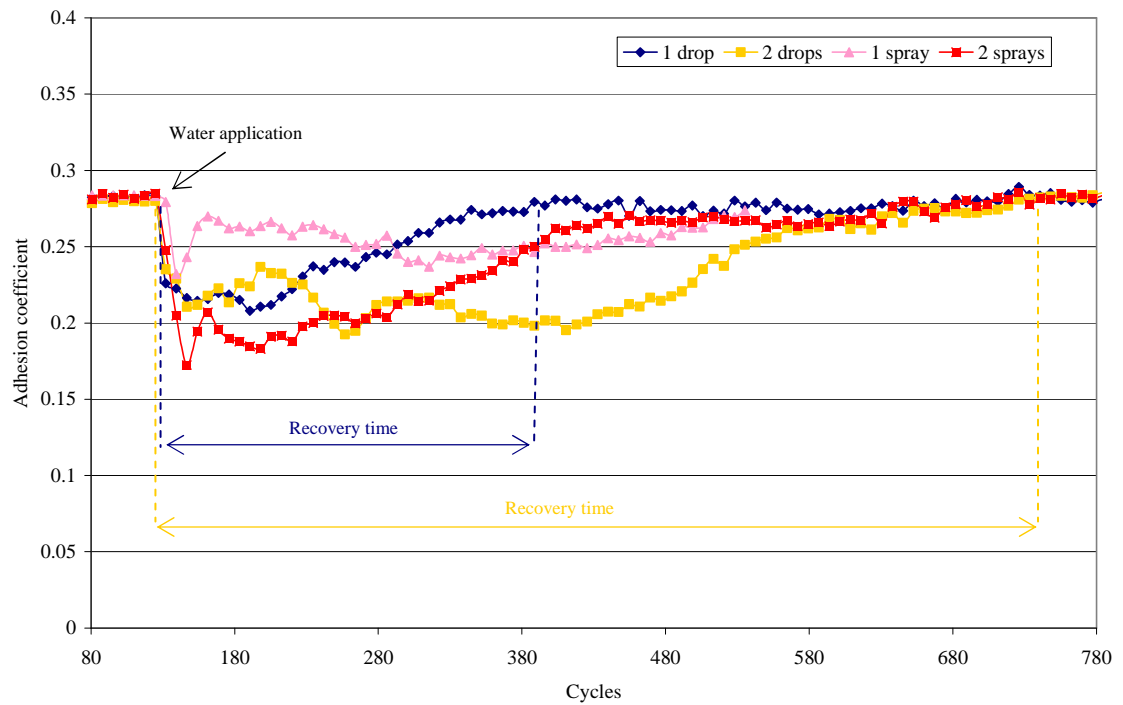

Fig. 16. Water application method tests at 0.5% slip.

Figs. 17-19 show the adhesion results obtained for the tests with water. In these tests, a single drop of water was applied no before the initial 20-50 cycles to ensure that the set slip had been reached. Care was taken that the water was applied before the friction modifier was entirely removed from the disk surfaces, which was established by examination of the results previously obtained in dry conditions tests. In addition, in the tests with FMs the drop of water was applied at around the same number of cycles for each slip tested to enable the comparison between them. As soon as water was entrained in the contact, the adhesion coefficient decreased. In wet conditions, the adhesion decreased to 0.2 for the baseline, and similarly for FMB. The lowest value in adhesion coefficient was observed with FMA and water, close to 0.07. The drop was smaller for FMA compared to baseline and FMB. Furthermore, the water applied seemed to interact with FMA forming a layer that remained throughout the tests at 0.5 and 1% slip. The shearing of that layer yielded an adhesion coefficient of 0.18-0.19. At 2% slip the layer was removed and starvation was reached at the end of the test. Special attention has to be paid to the sudden drop in adhesion in the initial part of the adhesion curve for FMA at 2%, which was due to the break-up of the layer as pointed out previously for the dry tests. Furthermore, in the presence of water the lasting effect of FMB was shortened. The water seemed to help to remove FMB faster in comparison with the dry conditions.



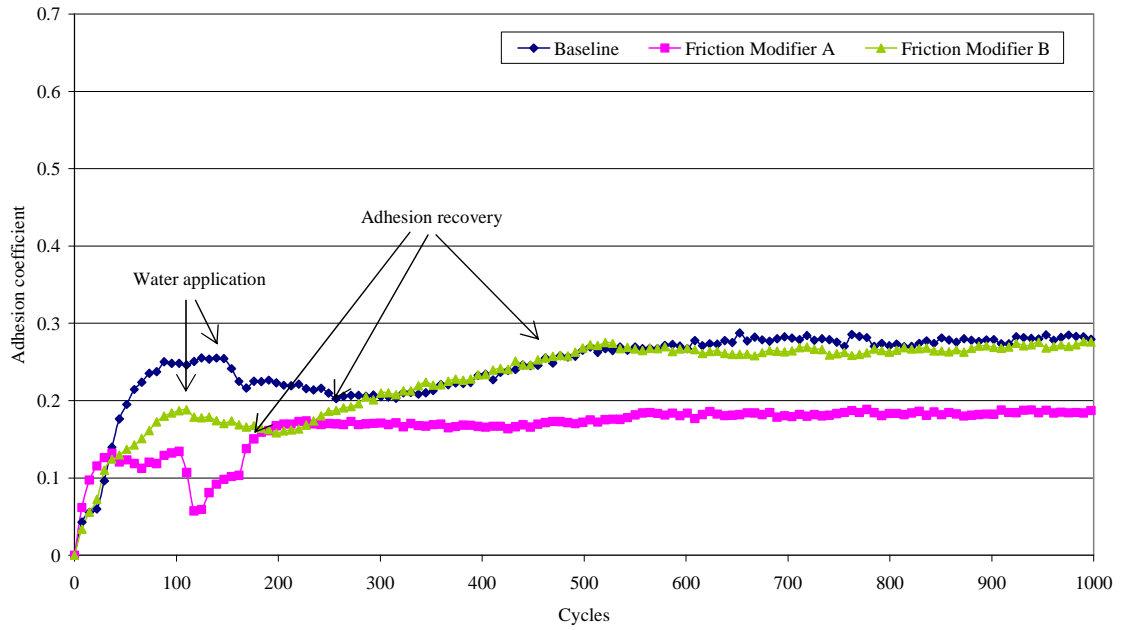

Fig. 17. Adhesion tests with one drop of water at 0.5% slip.

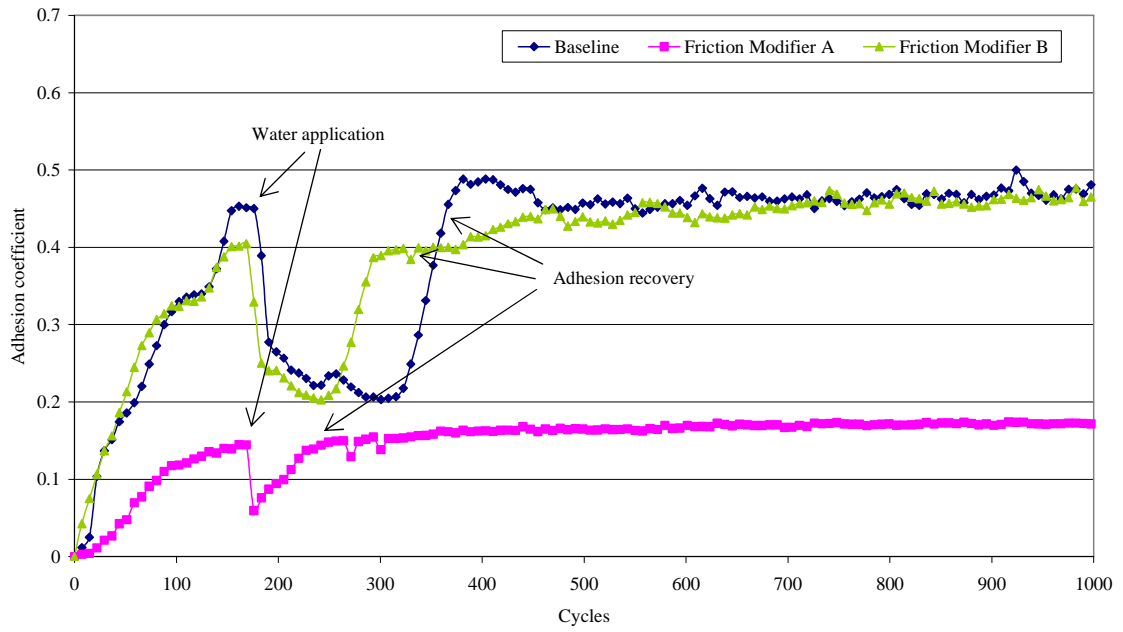

Fig. 18. Adhesion tests with one drop of water at 1% slip.

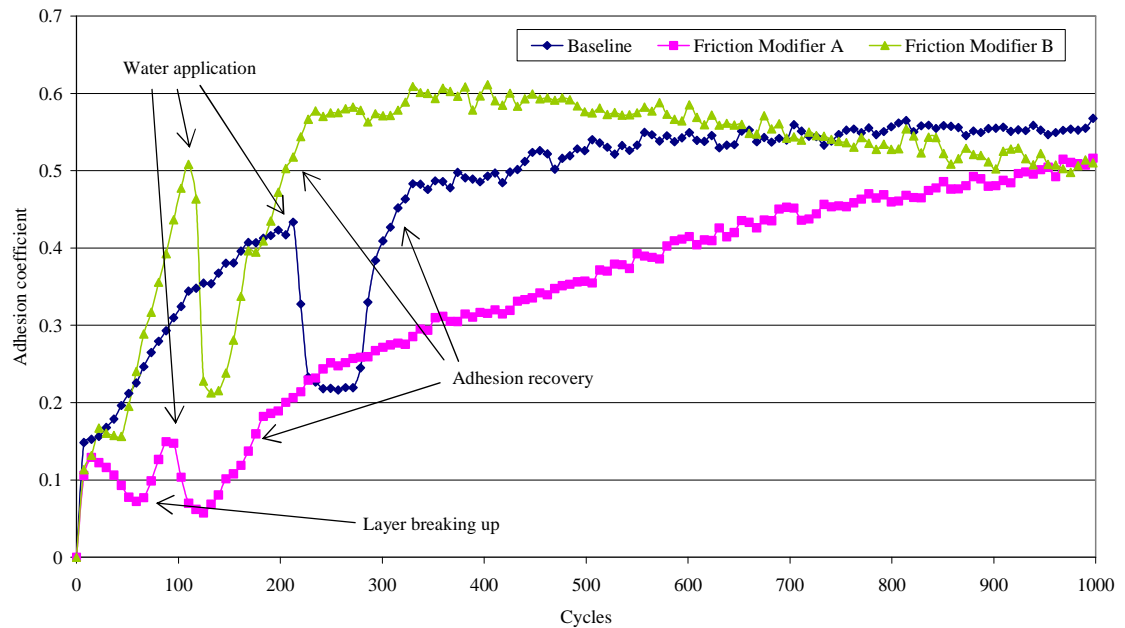

Fig. 19. Adhesion tests with one drop of water at 2% slip.

The recovery time observed in the tests is given in Table 4. FMA showed the shortest recovery times in comparison with FMB and baseline for all the slip ratios tested. The increase in slip led to shorter recovery times for the baseline, as it is expected due to the removal of the water by higher differential speeds. The recovery time for the FMs is influenced by the amount of product present on the disks surfaces once water is applied. It has already been pointed out that the increase in slip leads to a faster removal of the FMs from the disk surfaces. If an insufficient amount of FM is available, the recovery time will be similar to that of the baseline. This was observed for FMB at 1 and 2% slips. On the other hand, the slip seemed to have negligible influence on the recovery time of FMA, which could be attributed to its long lasting effect.

Table 4. Recovery time (cycles) with a drop of water for baseline, FMA and FMB at 0.5, 1 and 2% slip.

	0.5% slip	1% slip	2% slip
Baseline	316 cycles	190 cycles	103 cycles
Friction Modifier A	66 cycles	73 cycles	80 cycles
Friction Modifier B	147 cycles	183 cycles	103 cycles

#### **4. Discussion**

In dry conditions the highest adhesion levels are obtained with the baseline, which are 0.30-0.60 for the slip ratios considered. FMA shows moderate adhesion with values between 0.15 and 0.35 before starvation conditions are reached. FMB leads to adhesion values of 0.25-0.55. If water is applied to the disks contact, the adhesion coefficient drops between 30 and 65% depending on the slip and the FM used. The largest drop in adhesion is seen with both FMB and baseline. The lowest adhesion values are observed with FMA, which are around 0.07 in the presence of water. On the other hand, baseline and FMB have an adhesion coefficient around 0.2 in the same conditions. Furthermore, the water applied seems to interact with FMA forming a layer that was not removed during the tests at 0.5 and 1% slip. The shearing of that layer yielded an adhesion coefficient of 0.18-0.19. The adhesion requirements differ for traction and braking operations, and they also depend on the type of vehicle under consideration. An adequate braking performance demands an adhesion up to 0.09, whereas in traction this can be up to 0.20 [13]. Based on this, the low level of adhesion found with FMA in the presence of water may primarily lead to traction problems. On the other hand, the moderate adhesion level reached with FMA in dry contacts would be

advantageous to reduce wear and the occurrence of rolling contact fatigue defects (e.g., squats [21]) in rails subject to high tangential forces, like in accelerating/braking sections and short-radius curves. However, it has to be acknowledged that the adhesion coefficients obtained in this testing may not be completely in agreement with the actual wheel-rail adhesion, because of the differences between actual and laboratory testing conditions as already pointed out in [22]. Therefore, the results presented in this work can only be taken as qualitative of the actual wheel-rail situation to be used for comparisons between the products tested and the baseline.

In the presence of water the recovery time is one of the most important factors to consider, as it will determine the number of cycles in which the applied water exerts an influence on adhesion. The tests show that FMA has the shortest recovery times compared with FMB and baseline for the whole slip range studied. The increase in slip leads to shorter recovery times for the baseline, as it is expected due to the removal of the water by higher differential speeds. This removal effect also contributes to a faster removal of the FMs from the disk surfaces; therefore, the recovery time will approach the baseline if insufficient FM is available on the disk surfaces. This tendency was observed for FMB at 1 and 2% slips. On the other hand, the slip seemed to have negligible influence on the recovery time of FMA, which could be attributed to its long lasting effect.

The lasting effect of the FMs is a crucial parameter to take into account during the development stage of a FM because it has an economical impact on the costs of the railway network operators. The lasting effect of the FM will determine the frequency in which the FM has to be applied. In this study, it is shown that FMA has the longest lasting effect, which could be attributed to the strong matrix that is formed between the solid particles and the polymeric components. The adherence on the disk surfaces seems to be enhanced by the polymeric components. On the contrary, it seems that the solid particles in FMB tend to be removed from the disk surfaces once they are crushed due to the weak bond between particles and gelling agent. Furthermore, the lasting effect of FMB is reduced to a large extent in the presence of water.

The side effects in terms of damage to wheels and rails are a major concern when using FMs on a railway network. Rolling stock operators and infrastructure managers demand the damage to be as low as possible. In this work, it can be observed that the large particle size and hardness of the solid particles contained in FMB led to indentations on the disk surfaces. The hard large solid particles of FMB are necessary to be able to cut through the leaf layers that are formed in autumn on railheads, which is a design purpose of this FM. On the contrary, no indentations are observed with FMA. In order to reduce surface damage, the toughness, hardness and size of the solid particles of the FM should be optimized. Indentations were also observed when simple sanding was used to increase adhesion [12]. It was reported that sand particles embedded the softer wheel disk

and scored the harder rail disk, due to the large difference in hardness between the steel materials. In our work, however, indentations are present in both wheel and rail disks, which can be attributed to the small difference in hardness of the wheel and rail steels.

Furthermore, the moderate adhesion coefficients obtained with FMA in dry conditions lead to less plastic deformation on the disks compared to baseline and FMB. The wear rates were also reduced a factor of 3 in the tests with FMA compared to baseline and FMB. These facts would make FMA more beneficial from the railway maintenance point of view if the FMs are applied on sections where the rails experience high tangential forces as indicated above. Nevertheless, in these laboratory tests the disks have been scaled down, whereas the FMs have been used in real size; therefore, the results in wear and damage presented in this paper can only be taken as a reference of what happens in the actual wheel-rail contact, as already indicated in [12].

## **5. Conclusions**

A twin-disk roller rig is used to simulate the wheel-rail contact in controlled laboratory conditions so as to study the performance of two water-based friction modifiers (FMs) in dry and wet contacts. These two FMs have been used or tested in several railway networks as adhesion enhancers. In this work, tests with the FMs and the baseline are carried out in dry and wet conditions at different slip ratios. Surface and subsurface examination of the disks is undertaken in order to

assess the damage caused when using the FMs. The following conclusions are drawn:

- a) In dry conditions the highest adhesion coefficients are obtained with the baseline. FMA seems to form a durable third body layer that yields moderate adhesion coefficients in dry conditions, which could be beneficial from the point of view of railway maintenance.
- b) In the presence of water the adhesion coefficient is reduced to 0.2 for baseline and FMB, whereas 0.07 is reached for FMA. The latter may primarily lead to traction problems for the majority of the rail vehicles.
- c) FMA leads to a faster recovery time than both baseline and FMB for all the slip ratios considered. The increase in slip leads to shorter recovery time for the baseline, whereas it shows negligible influence on FMA. For FMB, the increase in slip leads to recovery times closer to the baseline due to the removal of FMB from the disk surfaces. Therefore, the use of adequate additives could enhance the adhesion recovery in wet contacts.
- d) FMA has longer lasting effect than FMB, which is attributed to its stronger matrix of solid particles and polymeric components. In the presence of water, the lasting effect of FMB is clearly reduced. Considering its impact on the costs of the railway network operator, improvements in the lasting effect of the FM are of importance.

- e) The lowest wear is obtained with FMA, while FMB shows similar wear rates with the baseline. The amount of plastic deformation follows the same pattern of the wear, as determined by the adhesion history.
- f) Severe surface damage is observed when using FMB due to its large hard solid particles, which cause indentations and scratches on both disks. No indentations are observed with FMA. In order to reduce surface damage, the toughness, hardness and size of the solid particles of the FM should be optimized.

### ***Acknowledgments***

The authors gratefully acknowledge Dr. Mike Frolich from the Engineering Materials Department of The University of Sheffield for his support in conducting the tests.

### ***References***

1. T.M. Beagley, C. Pritchard, Wheel/Rail Adhesion — The Overriding Influence of Water, *Wear* 35 (1975) 299-313.
2. T.M. Beagley, I.J. McEwen, C. Pritchard, Wheel/Rail Adhesion — The Influence of Railhead Debris, *Wear* 33 (1975) 141-152.
3. T.M. Beagley, I.J. McEwen, C. Pritchard, Wheel/Rail Adhesion—Boundary Lubrication by Oily Fluids, *Wear* 31 (1975) 77-88.
4. E.A. Gallardo-Hernandez, R. Lewis, Twin Disc Assessment of Wheel/Rail Adhesion, *Wear* 265 (2008) 1309-1316.



5. H. Chen, T. Ban, M. Ishida, T. Nakahara, Experimental Investigation on Influential Factors on Adhesion between Wheel and Rail under Wet Conditions, *Wear* 265 (2008) 1504-1511.
6. L. Deters, M. Proksch, Friction and Wear Testing of Rail and Wheel Material, *Wear* 258 (2005) 981-991.
7. W. Zhang, J. Chen, X. Wu, X. Jin, Wheel/Rail Adhesion and Analysis by Using Full Scale Roller Rig, *Wear* 253 (2002) 82-88.
8. D.T. Eadie, J. Kalousek, K.C. Chiddick, The Role of High Positive Friction (HPF) Modifier in the Control of Short Pitch Corrugations and Related Phenomena, *Wear* 253 (2002) 185-192.
9. D.T. Eadie, M. Santoro, J. Kalousek, Railway Noise and the Effect of Top of Rail Liquid Friction Modifiers: Changes in Sound and Vibration Spectral Distributions in Curves, *Wear* 258 (2005) 1148-1155.
10. D.T. Eadie, D. Elvidge, K. Oldknow, R. Stock, P. Pointner, J. Kalousek, P. Klauser, The Effects of Top of Rail Friction Modifier on Wear and Rolling Contact Fatigue: Full Scale Rail-Wheel Test Rig Evaluation, Analysis, and Modelling, *Wear* 265 (2008) 1222-1230.
11. U. Olofsson, R. Lewis, Tribology of the Wheel-Rail Contact, in: S. Iwnicki (Ed.), *Handbook of railway vehicle dynamics*, Taylor & Francis Group, Boca Raton, pp, 121-141, 2006.
12. R. Lewis, R.S. Dwyer-Joyce, Wear at the Wheel-Rail Interface when Sanding is Used to Increase Adhesion, *Journal of Rail and Rapid Transit* 220 (2006) 29-41.

13. C.R. Fulford, Review of low adhesion research, Report published by the Rail Safety and Standards Board, UK, 2004.
14. O. Arias-Cuevas, Z. Li, R. Lewis, E.A. Gallardo-Hernandez, Rolling-Sliding Laboratory Tests of Friction Modifiers in Leaf Contaminated Wheel-Rail Contacts, 2008 International Joint Tribology Conference, Miami, Florida, USA, October 20-22, 2008.
15. D.I. Fletcher, J.H. Beynon, Development of a Machine for Closely Controlled Rolling Contact Fatigue and Wear Testing, *Journal of Testing and Evaluation*, 28 (2000) 267-275.
16. E.A. Gallardo-Hernandez, R. Lewis, R.S. Dwyer-Joyce, Temperature in a Twin-disk Wheel/rail Contact Simulation, *Tribology International* 39 (2006) 1653-1663.
17. P.H. Dawson, M.B. Coyle, Metal Transfer During Rolling with Sliding—A Challenge, *Wear* 12 (1969) 385-386.
18. X. Lu, K.C. Wong, P.C. Wong, K.A.R. Mitchell, J. Cotter, D.T. Eadie, Surface Characterization of Polytetrafluoroethylene (PTFE) Transfer Films During Rolling-Sliding Tribology Tests Using X-ray Photoelectron Spectroscopy, *Wear* 261 (2006) 1155-1162.
19. W.R. Tyfour, J.H. Beynon, A. Kapoor, The Steady State Wear Behaviour of Pearlitic Rail Steel under Dry Rolling-sliding Contact Conditions, *Wear* 180 (1995) 79-89.
20. Y. Berthier, S. Descartes, M. Busquet, E. Niccolini, C. Desrayaud, L. Baillet, M.C. Baidetto-Dubourg, The Role and Effects of the Third Body in the Wheel-Rail

Interaction, Fatigue & Fracture of Engineering Materials & Structures 27 (2004) 423-436.

21. Z. Li, X. Zhao, C. Esveld, R. Dollevoet, M. Molodova, An Investigation into the Causes of Squats—Correlation Analysis and Numerical Modeling, Wear 265 (2008) 1349-1355.

22. H. Harrison, T. McCanney, J. Cotter, Recent Developments in Coefficient of Friction Measurements at the Wheel-Rail Interface, Wear 253 (2002) 114–123.

## ***Vitae***

Oscar Arias-Cuevas graduated from the Universidad Carlos III de Madrid, Spain, as Mechanical Engineer in January 2006. Prior to his graduation, he did his master thesis and traineeship in the Energetic Materials Department in the Dutch Organization for Applied Scientific Research (TNO) in Rijswijk, The Netherlands. Since February 2006 he has been working at the Railway Engineering Group of Delft University of Technology towards a PhD degree. The main topic of his PhD study is the low adhesion at the wheel-rail contact. He carries out research on possible solutions to the low adhesion problem by means of theoretical, simulation and experimental techniques. His fields of interest are: contact mechanics, friction, rail vehicle dynamics and multi-body dynamics.